



Catalogue

Motor protection and control

Manual motor starters, contactors and overload relays

Motor rated operational powers and currents

The currents given below concern standard three-phase four-pole cage motors (1500 r.p.m. at 50 Hz 1800 r.p.m. at 60 Hz). These values are given for guidance and may vary according to the motor manufacturer and depending on the number of poles.

IEC Motor power kW	Motor nominal current: standardized values in blue colour (according to IEC 60947-4-1 Annex G)									
	220 V A	230 V A	240 V A	380 V A	400 V A	415 V A	440 V A	500 V A	660 V A	690 V A
0.06	0.37	0.35	0.34	0.21	0.2	0.19	0.18	0.16	0.13	0.12
0.09	0.54	0.52	0.50	0.32	0.3	0.29	0.26	0.24	0.18	0.17
0.12	0.73	0.7	0.67	0.46	0.44	0.42	0.39	0.32	0.24	0.23
0.18	1	1	1	0.63	0.6	0.58	0.53	0.48	0.37	0.35
0.25	1.6	1.5	1.4	0.9	0.85	0.82	0.74	0.68	0.51	0.49
0.37	2.0	1.9	1.8	1.2	1.1	1.1	1	0.88	0.67	0.64
0.55	2.7	2.6	2.5	1.6	1.5	1.4	1.3	1.2	0.91	0.87
0.75	3.5	3.3	3.2	2.0	1.9	1.8	1.7	1.5	1.15	1.1
1.1	4.9	4.7	4.5	2.8	2.7	2.6	2.4	2.2	1.7	1.6
1.5	6.6	6.3	6	3.8	3.6	3.5	3.2	2.9	2.2	2.1
2.2	8.9	8.5	8.1	5.2	4.9	4.7	4.3	3.9	2.9	2.8
3	11.8	11.3	10.8	6.8	6.5	6.3	5.7	5.2	4	3.8
4	15.7	15	14.4	8.9	8.5	8.2	7.4	6.8	5.1	4.9
5.5	20.9	20	19.2	12.1	11.5	11.1	10.1	9.2	7	6.7
7.5	28.2	27	25.9	16.3	15.5	14.9	13.6	12.4	9.3	8.9
11	39.7	38	36.4	23.2	22	21.2	19.3	17.6	13.4	12.8
15	53.3	51	48.9	30.5	29	28	25.4	23	17.8	17
18.5	63.8	61	58.5	36.8	35	33.7	30.7	28	22	21
22	75.3	72	69	43.2	41	39.5	35.9	33	25.1	24
30	100	96	92	57.9	55	53	48.2	44	33.5	32
37	120	115	110	69	66	64	58	53	40.8	39
45	146	140	134	84	80	77	70	64	49.1	47
55	177	169	162	102	97	93	85	78	59.6	57
75	240	230	220	139	132	127	116	106	81	77
90	291	278	266	168	160	154	140	128	97	93
110	355	340	326	205	195	188	171	156	118	113
132	418	400	383	242	230	222	202	184	140	134
160	509	487	467	295	280	270	245	224	169	162
200	637	609	584	368	350	337	307	280	212	203
250	782	748	717	453	430	414	377	344	261	250
315	983	940	901	568	540	520	473	432	327	313
355	1109	1061	1017	642	610	588	535	488	370	354
400	1255	1200	1150	726	690	665	605	552	418	400
500	1545	1478	1416	895	850	819	745	680	515	493
560	1727	1652	1583	1000	950	916	832	760	576	551
630	1928	1844	1767	1116	1060	1022	929	848	643	615
710	2164	2070	1984	1253	1190	1147	1043	952	721	690
800	2446	2340	2243	1417	1346	1297	1179	1076	815	780
900	2760	2640	2530	1598	1518	1463	1330	1214	920	880
1000	3042	2910	2789	1761	1673	1613	1466	1339	1014	970

UL / CSA Motor power hp	Motor nominal current: standardized values (according to IEC 60947-4-1 Annex G and UL 508)				
	208 V A	220-240 V A	380-415 V A	440-480 V A	550-600 V A
1/2	2.4	2.2	1.3	1.1	0.9
3/4	3.5	3.2	1.8	1.6	1.3
1	4.6	4.2	2.3	2.1	1.7
1-1/2	6.6	6	3.3	3	2.4
2	7.5	6.8	4.3	3.4	2.7
3	10.6	9.6	6.1	4.8	3.9
5	16.7	15.2	9.7	7.6	6.1
7-1/2	24.2	22	14	11	9
10	30.8	28	18	14	11
15	46.2	42	27	21	17
20	59.4	54	34	27	22
25	74.8	68	44	34	27
30	88	80	51	40	32
40	114	104	66	52	41
50	143	130	83	65	52
60	169	154	103	77	62
75	211	192	128	96	77
100	273	248	165	124	99
125	343	312	208	156	125
150	396	360	240	180	144
200	528	480	320	240	192
250	-	604	403	302	242
300	-	722	482	361	289
350	-	828	560	414	336
400	-	954	636	477	382
450	-	1030	-	515	412
500	-	1180	786	590	472

Motor protection and control

Manual motor starters, contactors and overload relays

Overview	1
Manual motor starters	2
B mini contactors	3
AS contactors	4
AF, A and EK contactors	5
Overload relays	6
R contactors	7
Motor management system	8
Coordination with short-circuit protection devices	9
Index	10

Extensive range of contactors

1 High performance contactors for your applications from 9 to 5000 A



Mini contactors for compact equipments - up to 5.5 kW / 5 hp
Contactors for all industrial applications up to 2050 A and motor starting-up to 560 kW (400 V) / 900 hp (480 V)
Contactors for heavy duty applications - up to 5000 A, 1000 V AC / 1500 V DC

- Complete and harmonized 3 and 4-pole ranges.
- High performance and high quality materials.
- Compact dimensions easy to integrate in all designs.
- AF contactors with electronic coil interface:
 - wide voltage range AC / DC, sag and dips immunity,
 - built-in surge suppressor.
- Complying with the latest international standards.

The right choice for many applications

- Pumps
- HVAC
- Compressors
- Power supply solutions
- Packing machines
- Cranes
- Elevators and escalators
- Moulding machines
- Wood machines
- Robot
- Windmill
- Solar system
- Water heating
- Fuel cells
- Traction

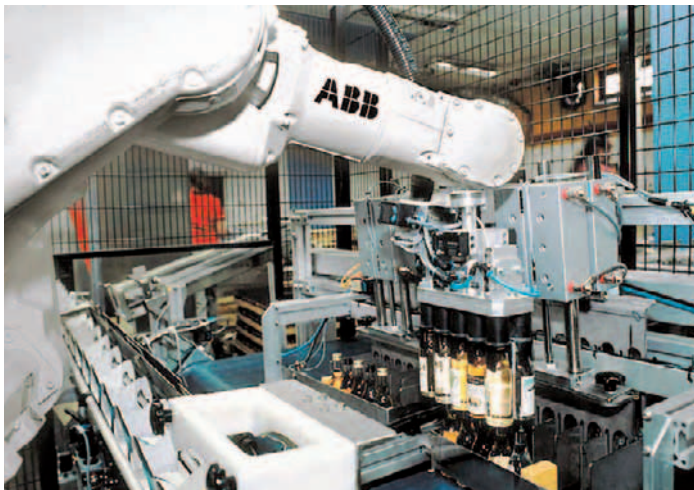



Motor starting solutions

- Perfect match in starter assembly with a large range of accessories.
- Short-circuit protection, type 1 and 2 coordination.
- Large offer of accessories for direct-on-line, reversing and star-delta starters which allows:
 - time / cost saving,
 - secure connection,
 - aesthetic starters,
 - easy assembly and wiring.



1S6C101623C0201

3-pole contactors

Mini contactors

Contactors for all industrial

1



IEC	AC-3 Rated operational power	$\theta \leq 55^\circ\text{C}^*$, 400 V	kW	4	5.5	4	5.5	7.5	4	5.5	7.5	11	15	18.5
UL/CSA	3-phase motor rating	480 V	hp	3	5	5	7.5	10	5	7.5	10	15	20	20
AC Control supply			Type	B6	B7	AS09	AS12	AS16	AF09	AF12	AF16	AF26	AF30	AF38
DC Control supply			Type	BC6	BC7	ASL09	ASL12	ASL16	AF09	AF12	AF16	AF26	AF30	AF38
AC / DC Control supply			Type	—	—	—	—	—	AF09	AF12	AF16	AF26	AF30	AF38
IEC	AC-3 Rated operational current	$\theta \leq 55^\circ\text{C}^*$, 400 V	A	9	12	9	12	15.5	9	12	18	26	32	38
	AC-1 Rated operational current	$\theta \leq 40^\circ\text{C}$, 690 V	A	16	20	22	24	24	25	28	30	45	50	50
UL/CSA	General use rating	600 V	A	12 (300 V)	16	20	20	20	25	28	30	45	50	50
NEMA	NEMA Size			—	—	00	00	0	00	0	—	1	—	—

* $\theta \leq 60^\circ\text{C}$ for AS(L)09 ... AS(L)16 and AF09 ... AF38 contactors

Main accessories

Auxiliary contact blocks	Front mounting	CAF6	CA3-10 (1 x N.O.), CA3-01 (1 x N.C.)	CA4-10 (1 x N.O.), CA4-01 (1 x N.C.) CAL4-11 (1 x N.O. + 1 x N.C.)
	Side mounting	CA6		
Timers	Pneumatic (Front mounting)			
	Electronic		TEF3-ON, TEF3-OFF	
Interlocking units (1)	Mechanical		VM3	VM4
	Mechanical / Electrical			VEM4
Connection sets	For reversing contactors	BSM6-30	BER16C-3	BER16-4 BER38-4
Surge suppressors	Varistor (AC/DC)	RV-BC6	RV5 (24...440 V)	
	RC type (AC)		RC5-1 (24...440 V)	
	Transil diode (DC)	RD7	RT5 (12...264 V)	

(1) See available reversing contactors VB6, VB7 and VAS09 ... VAS16

Overload relays

Thermal relays	Class 10 (10A or 20 for TA42DU to TA80DU)	T16 (0.10...16 A)	T16 (0.10...16 A)	TF42 (0.10...38 A)
Electronic relays	Class 10E, 20E, 30E	E16DU (0.10...18.9 A)		EF19 (0.10...18.9 A) EF19 (0.10...18.9 A), EF45 (9...45 A)
Accessories for thermal overload relays	Remote tripping coil			
	Remote reset coil			
	Wall/separate mounting kit	DB16 (T16 only), DB16E (E16DU only)		DB42 (TF42 only)

Manual motor starters

	Thermal / magnetic protection	Class 10	MS116 for class 10A (0.16...32 A) Ics up to 50 kA MS132 (0.10...32 A) Ics up to 100 kA	MS116 for class 10A (0.16...32 A) Ics up to 50 kA MS132 (0.10...32 A) Ics up to 100 kA	MS450
		Class 20			MS497 MS451
	Magnetic only types			MO132 (0.10...32 A)	
Accessories	For contactor mounting		BEA7/132	BEA16-3 BEA16-4	BEA38-4
	Auxiliary trip units, auxiliary contacts, busbars		HKF1, HK1, UA1, AA1, PS1, S1, SK1, CK1 (MS132 only)	HKF1, HK1, UA1, AA1, PS1, S1, SK1, CK1 (MS132, MO132 only)	HK4,

applications and motor starting



1

18.5	22	30	37	45	55	75	90	110	140	160	200	250	315	400	—	475	560	—
30	40	60	60	60	75	100	125	150	200	250	350	400	500	600	—	800	900	—
A40	A50	A63	A75	A95	A110	A145	A185	A210	A260	A300	AF400	AF460	AF580	AF750	AF1250	AF1350	AF1650	AF2050
AL40	AE50	AE63	AE75	AF95	AF110	AF145	AF185	AF210	AF260	AF300	AF400	AF460	AF580	AF750	AF1250	AF1350	AF1650	AF2050
—	AF50	AF63	AF75	AF95	AF110	AF145	AF185	AF210	AF260	AF300	AF400	AF460	AF580	AF750	AF1250	AF1350	AF1650	AF2050
37	50	65	75	96	110	145	185	210	260	305	400	460	580	750	—	860	1050	—
60	100	115	125	145	160	250	275	350	400	500	600	700	800	1050	1260	1350	1650	2050
60	80	90	105	125	140	230	250	300	350	400	550	650	750	900	1210	1350	1650	2100
—	2	—	3	—	—	4	—	—	5	—	—	6	—	7	—	—	8	—

CA5-10 (1 x N.O.), CA5-01 (1 x N.C.)																		
CAL5-11 (1 x N.O. + 1 x N.C.)	CAL18-11 (1 x N.O. + 1 x N.C.)																	
TP40DA, TP180DA Direct timing TP40IA, TP180IA Inverse timing																		
VM5-1	VM300H / VM300V		VM750H / VM750V		VM1650H													
VE5-1	VE5-2																	
BER40V	BEM75-30		BEM110-30		BEM185-30		BEM300-30		BEM460-30		BEM750-30							
RV5 (24...440 V)																		
RC5-1 (24...440 V)	RC5-2 (24...440 V)		RC5-3 (250...440V)															
RT5 (12...264 V)																		

TA42DU (18...42 A)	TA75DU (18...80 A)	TA80DU (29...80 A) TA110DU (65...110 A)	TA200DU (66...200 A)	TA450DU/SU (130...310 A) class 30 for SU					
E45DU (9...45 A)	E80DU (27...80 A)	E140DU (50...140 A)	E200D-U (60...200 A)	E320DU (100...320 A)	E500DU (150...500 A)	E800DU (250...800 A)	E1250DU (375...1250 A)		
				DS25-A					
				DR25-A					
DB80, DB45E, DB80E		DB80, DB200, D140E	DB200	DT450/A					

Circuit breakers

(40...50 A) Ics up to 50 kA	MS495 (28...100 A) Ics up to 50 kA	Tmax Circuit breaker and accessories
(11...100 A) Ics up to 100 kA		
(11...50 A) Ics up to 50 kA	MS496 (28...100 A) Ics up to 100 kA	
MO450 (16...50 A) Ics up to 50 kA	MO495 (40...100 A) Ics up to 50 kA	
MO496 (16...100 A) Ics up to 100 kA		
BEA40/450	BEA50/450, BEA75/495	
HKS4, UA4, AA4, PS4, S4, SK4		

1SBC101637S0201

4-pole contactors

1

Mini contactors



IEC	AC-1 Rated operational current	$\theta \leq 40\text{ }^{\circ}\text{C}$, 690 V	A	16	20
UL/CSA	General use rating	600 V	A	12 (300 V)	16
AC Control supply			Type	B6	B7
DC Control supply			Type	BC6	BC7
AC / DC Control supply			Type	—	—

Contactor relays

Mini contactor relays



IEC	AC-15 Rated operational current	400 V	A	3
UL/CSA	Pilot duty			A 600
AC Control supply			Type	K6-22Z K6-31Z K6-40E
DC Control supply			Type	KC6-22Z KC6-31Z KC6-0E
AC / DC Control supply			Type	— — —

R contactors

DC Circuit switching



DC-1 Rated current up to 5000 A
 DC-3/DC-5 Rated current up to 2000 A
 1500 V with poles in series

IOR.. 63-...-CC to IOR.. 5100-...-CC

Specific contactors

DC Circuit switching



100 A, 440 V, DC-1
 GA75, GAE75 types



275 to 2050 A, 1000 V, DC-1
 GAF185 to GAF2050 types

Contactors

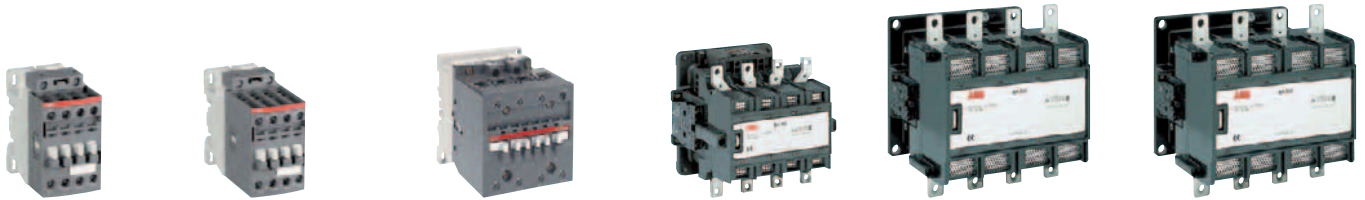

25	30	45	55	70	100	125	200	250	300	350	550	800	1000
25	30	45	55	80	80	105	170	200	250	300	420	540	—
AF09	AF16	AF26	AF38	A45	A50	A75	EK110	EK150	EK175	EK210	EK370	EK550	EK1000
AF09	AF16	AF26	AF38	AE45	AE50	AE75	EK110	EK150	EK175	EK210	EK370	EK550	EK1000
AF09	AF16	AF26	AF38	AF45	AF50	AF75	—	—	—	—	—	—	—

Contactor relays



3			3		
A 600, Q 300			A 600, Q 600		
NS22E	NS31E	NS40E	NF22E	NF31E	NF40E
NSL22E	NSL31E	NSL40E	NF22E	NF31E	NF40E
—	—	—	NF22E	NF31E	NF40E

AC Circuit switching

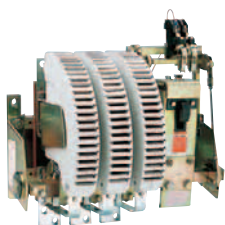

AC-1 Rated current up to 5000 A
AC-3 Rated power up to 1500 kW
(1520 A - 440 V)

IOR.. 63...-MT to IOR.. 5100...-MT

Special versions

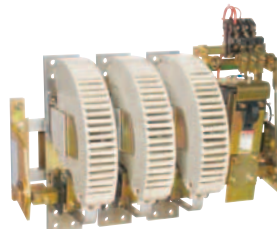

AC/DC Coupling: LOR.. contactors
Slip ring motor control: FOR .. contactors
Field discharge: AM(F)-CC-JORE contactors
AC/DC Switching (N.C./N.O. main poles):
NOR & JOR contactors
Latching contactors for energy saving
and safety requirements: AMA or AME contactors

Capacitor switching



12.5 to 80 kvar
UA16..RA to UA110..RA types
UA16 to UA110 types

Magnetical latching



3 N.O. poles,
22 to 160 kW, 400 V, AC-3
2 N.O. + 2 N.C. poles,
70 to 125 A, AC-1
AM45 to AM300 types

ABB's new control and protection devices

Up to 18.5 kW / 20 hp

1

One product family

ABB presents a new generation of first-class specialized components: manual motor starters, contactors, overload relays and softstarters for motor starting solutions up to 18.5 kW / 20 hp

- Harmonized design & colour
- Compact and modular
- Low energy consumption
- Small number of parts
- Minimum need for accessories
- Optimized wiring and configuration
- High ratings and service capability
- Increased application possibilities
- Reliability proven over many years of experience



Simplicity for your design

Our engineers have taken modularity and uniformity to the next level in terms of flexibility and practicality for your applications. We offer you flexibility, increased application possibilities, exchangeability and reduced panel size.



Safety and reliability

ABB's new line of industrial motor control and protection devices has been developed in order to meet the main safety standards of the toughest industrial scenarios where high reliability and safety level are required.

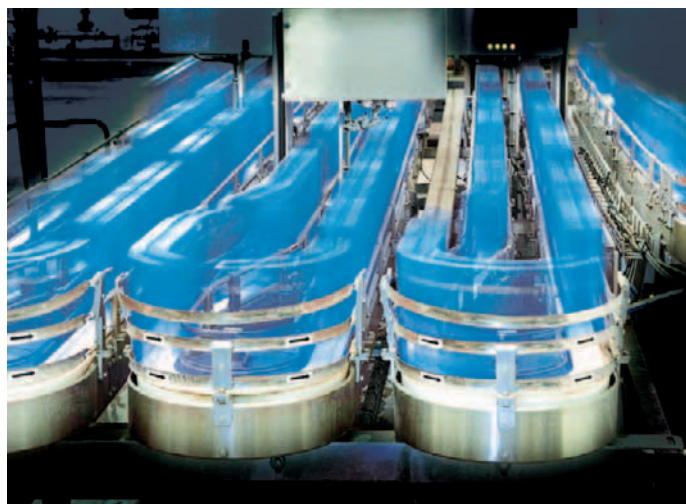

Increased availability for your equipment

Designing with simplicity in mind, our engineers have made it possible to integrate the entire family into just a few components. We offer you reduced inventory, greater exchangeability, to help you to have fewer mistakes and shortages and less down time.



Energy efficiency and sustainability

Reducing energy consumption and protecting the environment has long been at the top of ABB's list of priorities, and we are proud to introduce a first-class proposal.



Large choice of starting solutions in kit form

1

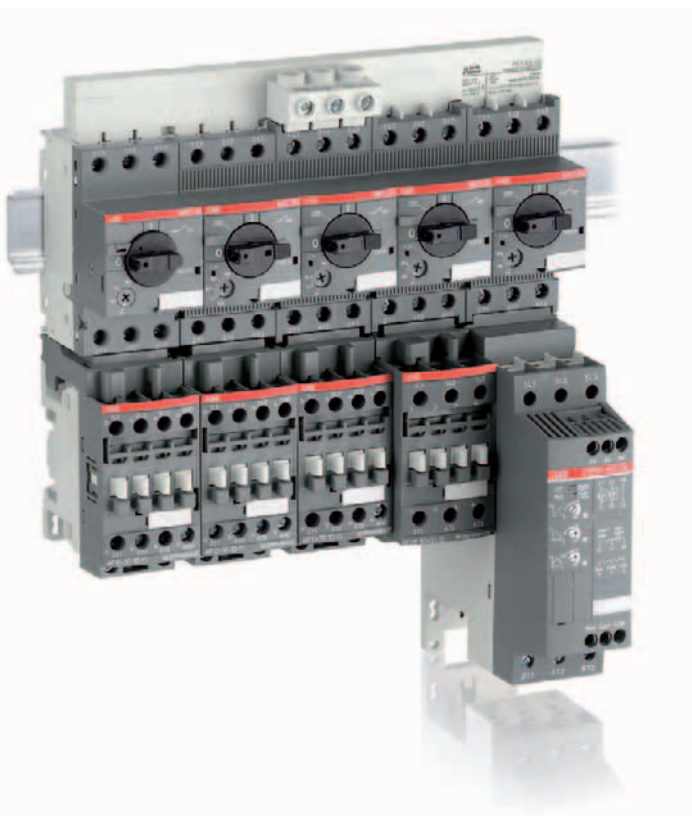

Short-circuit and overload protection

- Type 1 or type 2 coordination guaranteed with manual motor starters
- Choice of thermal or electronic overload relays

Simple construction

- All starters in 45 mm width module

Time/cost saving

- Same frame size for AC or DC control supply
- Easy, fast and secure assembly, fitting and wiring of components

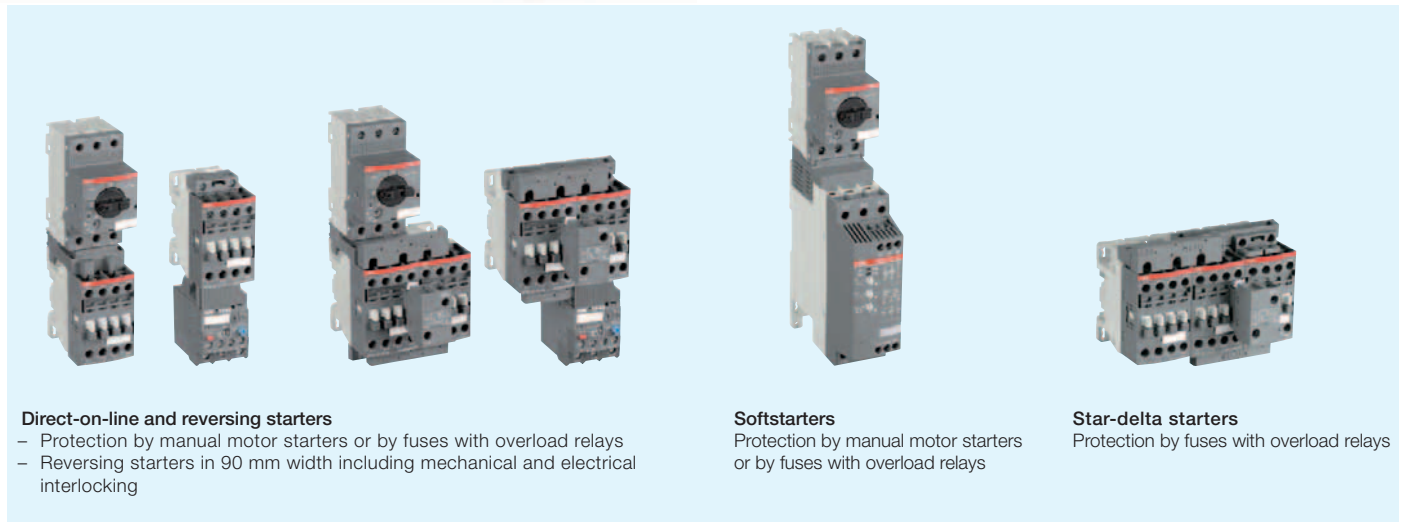

Direct-on-line and reversing starters

- Protection by manual motor starters or by fuses with overload relays
- Reversing starters in 90 mm width including mechanical and electrical interlocking

Softstarters

- Protection by manual motor starters or by fuses with overload relays

Star-delta starters

- Protection by fuses with overload relays

Standardized busbars and optimized interconnection accessories

- Same 3-phase busbar and feeder range up to 100 A for manual motor starters
- Direct 35 mm rail mounting: no additional mounting plate required
- Complete range of connection links with manual motor starters and connection sets to build reversing and star-delta starters
- Easy installation and dismantling of contactors: no unwiring of manual motor starters

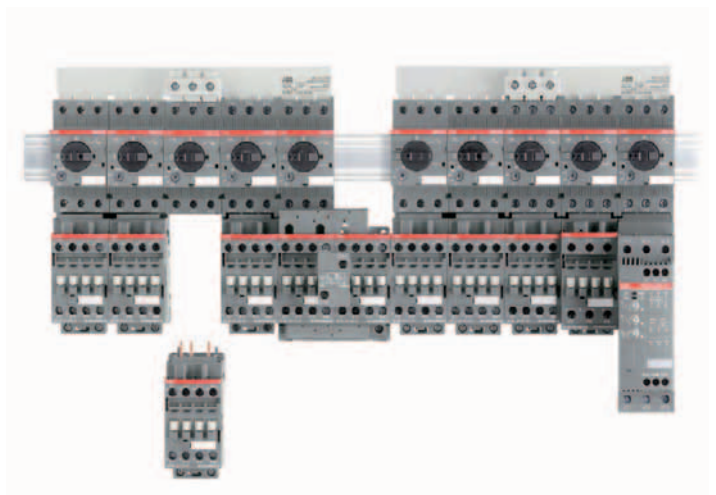



Protect your motors with thermal or electronic overload relays

- One range of TF42 thermal overload relays, trip class 10
- One range of EF19 and EF45 electronic overload relays up to 45 A, 7 setting ranges, trip class 10E, 20E, 30E
- Adjustable current setting ranges
- Overload protection with phase loss sensitivity
- Temperature compensation:
 - up to +60 °C for thermal overload relays
 - up to +70 °C for electronic overload relays
- Automatic or manual reset, sealable
- Stop and test function

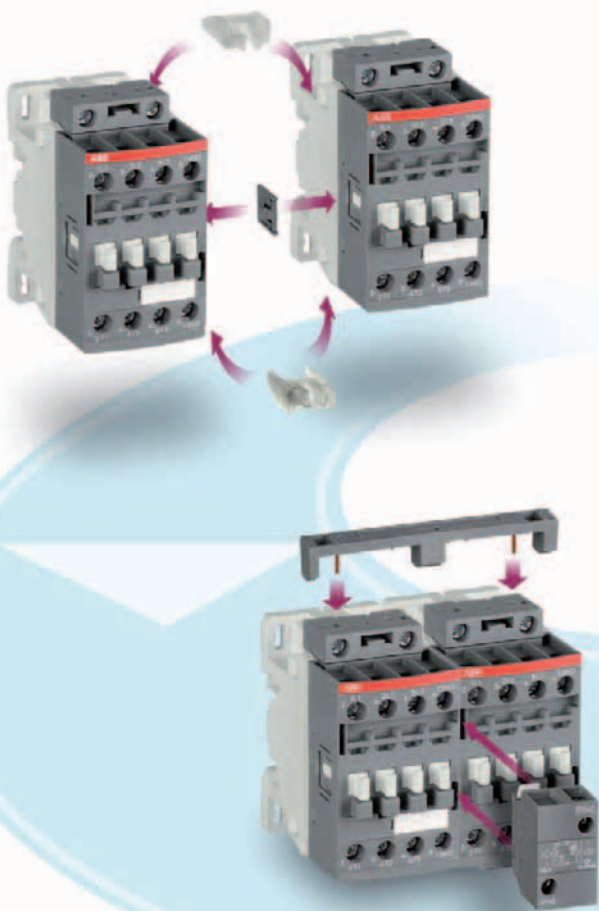
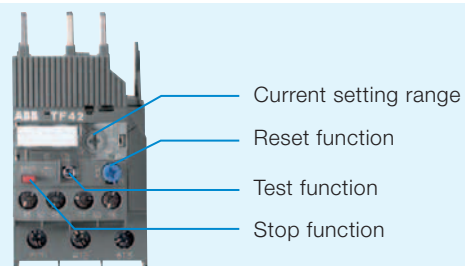
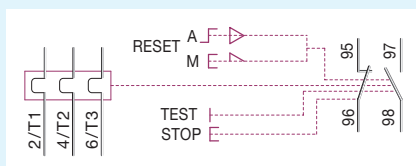

Interlock your reversing contactors quickly in 90 mm width:

- Easy with VM4 mechanical interlock unit
- Simple with VEM4 set including mechanical interlock unit and electrical interlock block with A2-A2 connection
- 50% wiring cost savings in one click!

Fixing the electrical interlock block to the contactor front face connects the 2 built-in N.C. interlocking contacts with the two coil supplies

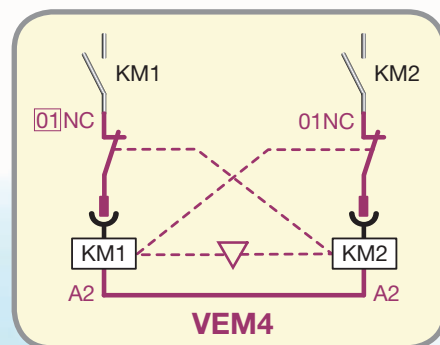

MS116 and MS132 manual motor starters

Harmonized design in 45 mm width

1



Types	MS116	MS132
Setting range	0.1 ... 32 A	0.1 ... 32 A
Switch position	ON / OFF	ON / OFF / TRIP
Magnetic trip indication	-	yes
Lockable handle without accessories	-	yes
Max. breaking capacity I_{cs}	up to 50 kA	up to 100 kA
Trip class	10A	10

ON/OFF switch functionality

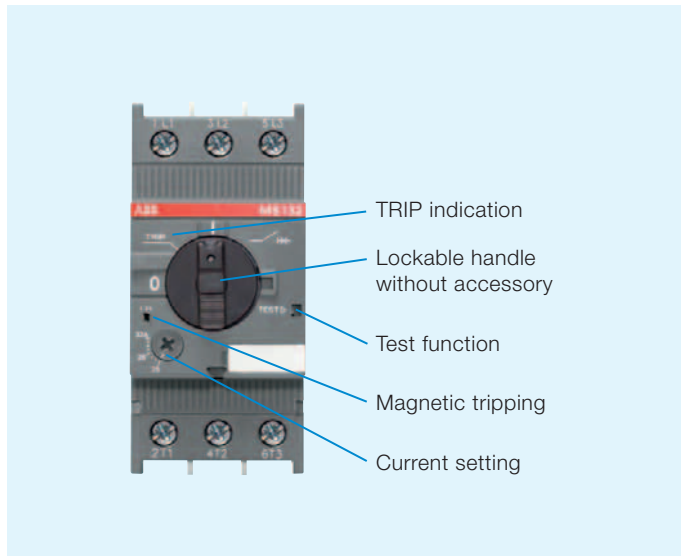

Clear tripping identification

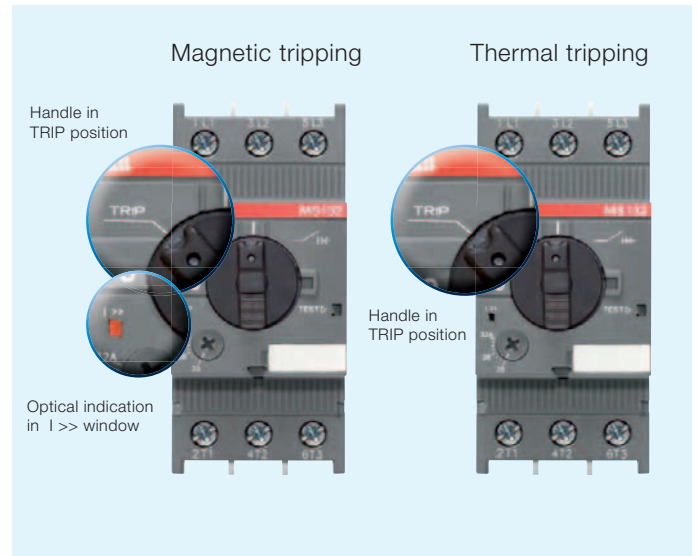

One range of accessories for MS116 and MS132

- Common auxiliary contacts, signaling contacts and auxiliary trip units
- Common busbar systems

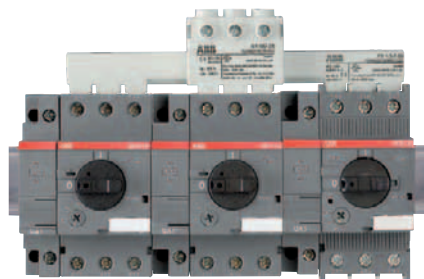
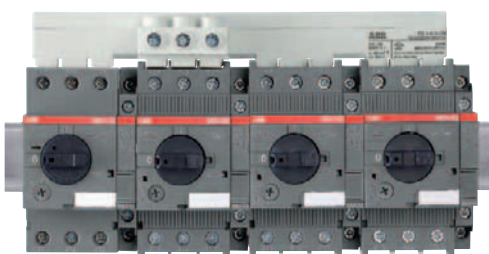

AF09 ... AF38 3-pole contactors

Simple design with 2 frame sizes in 45 mm width



Types	AF09	AF12	AF16	AF26	AF30	AF38
Rated operational power 400 V AC-3	4 kW	5.5 kW	7.5 kW	11 kW	15 kW	18.5 kW
Rated operational current AC-1 (40 °C)	25 A	28 A	30 A	45 A	50 A	50 A
UL 3-phase motor power 480 V	5 hp	7.5 hp	10 hp	15 hp	20 hp	20 hp

A unique contactor for AC or DC control supply

- Manages large control voltage variations
- Includes an electronic coil interface with extended operating limits $0.85 \times U_c \text{ min.} \dots 1.1 \times U_c \text{ max.}$

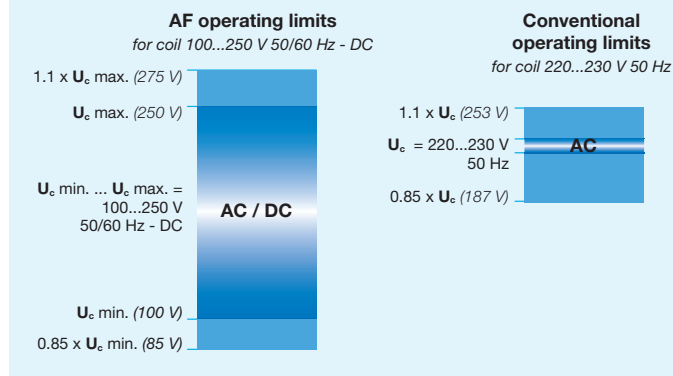

Only four coils for easier selection

Control voltages covering 24...500 V 50/60 Hz and 20...500 V DC

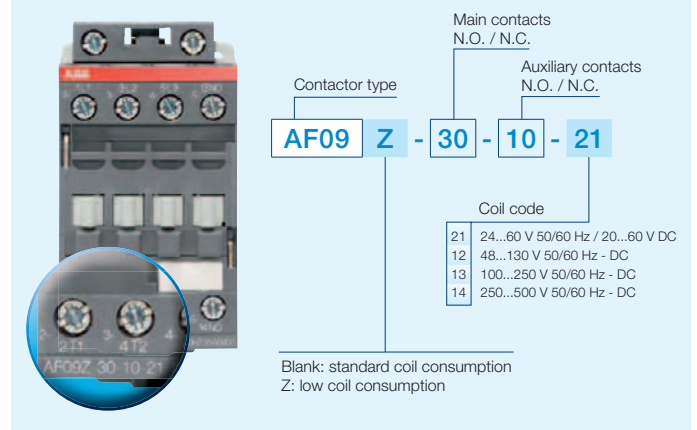

Reduced panel energy consumption

- With low holding AC and DC coil consumption
- From 30% (AF coil) to 80% (AF.Z coil) reduction of AC pull-in consumption

Built-in surge protection

- No extra surge suppressor required

Improve your equipment reliability with AF.Z contactors

- Withstands control voltage short dips
- Withstands control voltage sags according to SEMI F47-0706 standards
- Additional AF.Z coils available for control voltages between 12...20 V DC and 48...250 V 50/60 Hz - DC

Direct control by PLC-output ≥ 500 mA, 24 V DC

No use of interface relay

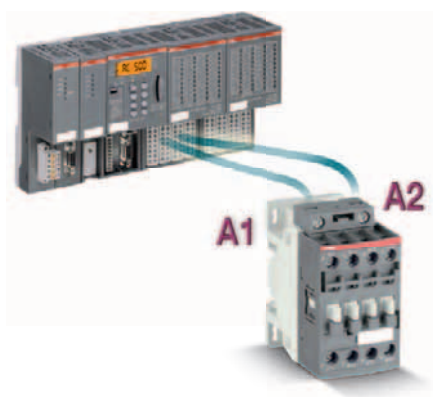

Switching of auxiliary and control circuits



1



Optimize your auxiliary contact block configuration

- AF09...AF16 3-pole contactors equipped with a built-in auxiliary contact N.O. or N.C.
- Up to 6 additional auxiliary contacts:
 - front-mounted 1 or 4-pole CA4 blocks
 - side-mounted 2-pole CAL4 blocks
- Reduced panel dimension using up to 2 side-mounted 2-pole CAL4 blocks

Make your control circuit safe

- **Mirror contact**  according to IEC 60947-4-1 Annex F 2.1
- **Mechanically linked contacts**  according to IEC 60947-5-1 Annex L 3.0

Free choice of your coil terminal access

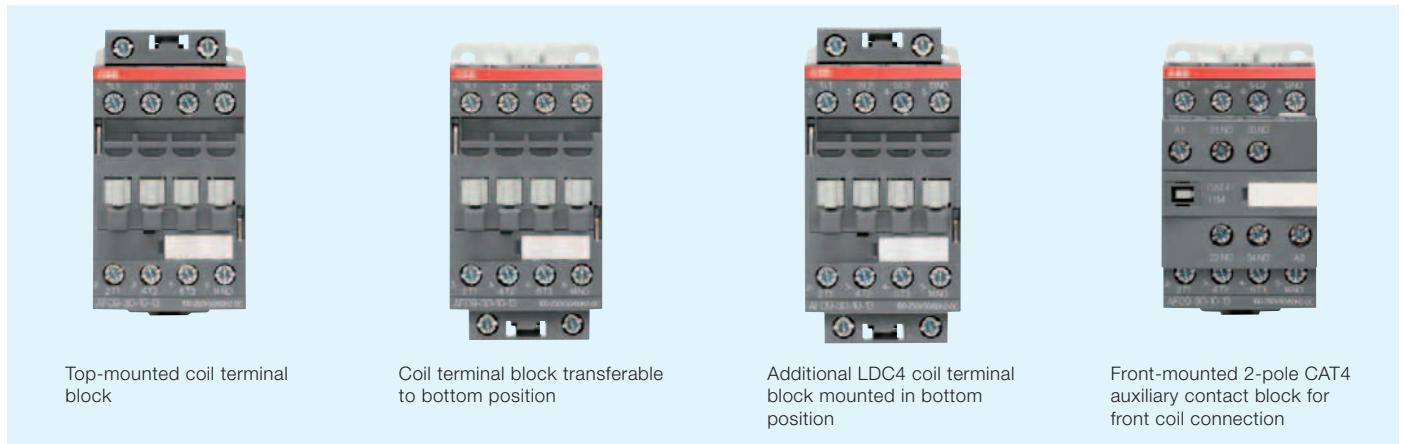

Top-mounted coil terminal block

Coil terminal block transferable to bottom position

Additional LDC4 coil terminal block mounted in bottom position

Front-mounted 2-pole CAT4 auxiliary contact block for front coil connection

Protect your equipment against accidental contact

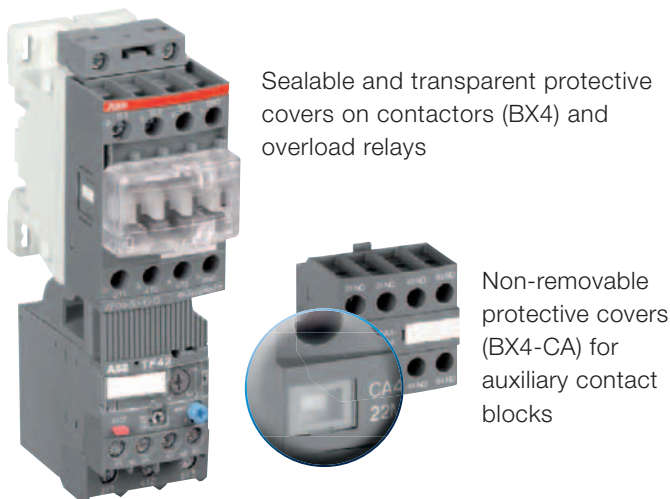

Sealable and transparent protective covers on contactors (BX4) and overload relays

Non-removable protective covers (BX4-CA) for auxiliary contact blocks

Complete choice of contactor relays

- Same advantages and accessories as AF contactors
- Only four coils for easier selection

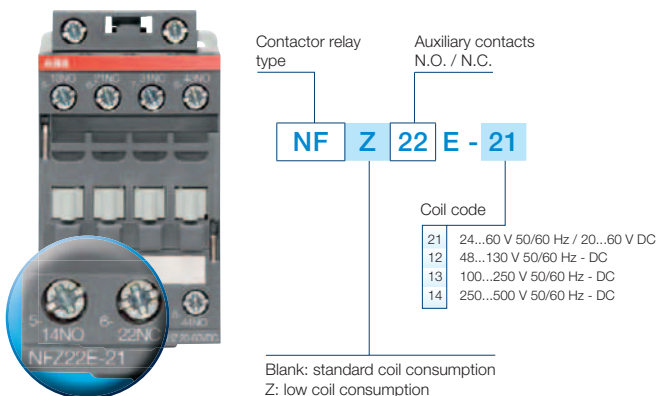

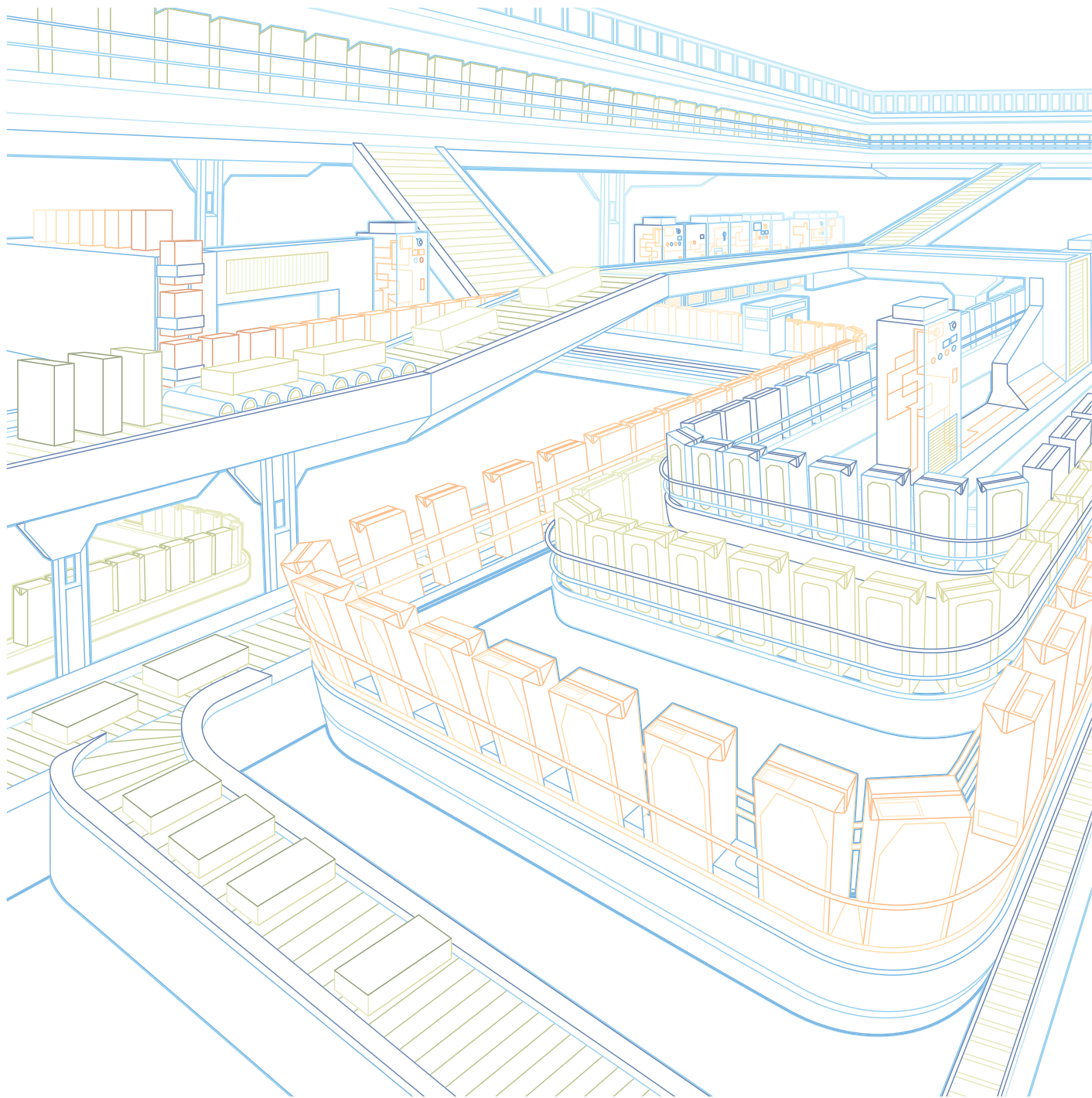



0.10 to 32 A – with thermal and electromagnetic protection

Ics up to 50 kA

MS116 manual motor starters	2/2
Technical data	2/3
Main accessories	2/6

Ics up to 100 kA

MS132 manual motor starters	2/10
Technical data	2/11
Main accessories	2/14

0.10 to 32 A – with electromagnetic protection

MO132 manual motor starters	2/18
Technical data	2/19
Main accessories	2/23

22 to 100 A – with thermal and electromagnetic protection

MS450, MS495, MS497 manual motor starters	2/24
Technical data	2/25
Main accessories	2/27

16 to 100 A – with electromagnetic protection

MO450, MO495, MO496 manual motor starters	2/32
Technical data	2/33
Main accessories	2/35

0.10 to 25 A – with thermal and electromagnetic protection

MS325 manual motor starters	2/40
Technical data	2/41
Main accessories	2/44

0.4 to 25 A – with electromagnetic protection

MO325 manual motor starters	2/49
Technical data	2/50
Main accessories	2/52

MS116 manual motor starters

0.10 to 32 A – with thermal and electromagnetic protection

2

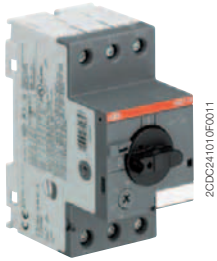

MS116-16

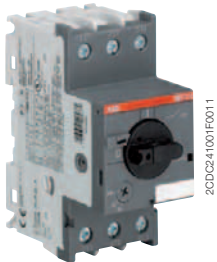

MS116-25

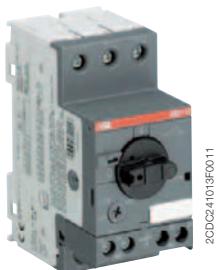

MS116-0.16-HKF1-11



MS116-32-HKF1-11

Description

Manual motor starters (MMS) are protection devices for the main circuit. They combine motor control and protection in a single device. MMS are used mainly to switch motors manually ON/OFF and protect them and the installation fuse less against short-circuit, overload and phase failures. Fuse less protection with a manual motor starter saves costs, space and ensures a quick reaction under short-circuit condition, by switching off the motor within milliseconds.

MS116 is a compact and economic range for motor protection up to 7.5 kW (400 V) / 32 A in width of 45 mm. Further features are the build-in disconnect function, temperature compensation, trip-free mechanism and a rotary handle with a clear switch position indication. The manual motor starter is suitable for three- and single-phase applications. Auxiliary contacts, signalling contacts, undervoltage releases, shunt trips, three-phase bus bars, power in-feed blocks and locking devices for protection against unauthorized changes are available as accessory.

Ordering details

Rated operational power 400 V AC-3	Rated operational current	Short-circuit breaking capacity I_{cs} at 400 V AC	Rated instantaneous short-circuit current setting I_i	Type	Order code	Weight (1 pce)
kW	A	kA	A			kg
0.03	0.10 ... 0.16	50	1.56	MS116-0.16	1SAM250000R1001	0.225
0.06	0.16 ... 0.25	50	2.44	MS116-0.25	1SAM250000R1002	0.225
0.09	0.25 ... 0.40	50	3.90	MS116-0.4	1SAM250000R1003	0.225
0.12	0.40 ... 0.63	50	6.14	MS116-0.63	1SAM250000R1004	0.225
0.25	0.63 ... 1.00	50	11.50	MS116-1.0	1SAM250000R1005	0.225
0.55	1.00 ... 1.60	50	18.40	MS116-1.6	1SAM250000R1006	0.265
0.75	1.60 ... 2.50	50	28.75	MS116-2.5	1SAM250000R1007	0.265
1.5	2.50 ... 4.00	50	50.00	MS116-4.0	1SAM250000R1008	0.265
2.2	4.00 ... 6.30	50	78.75	MS116-6.3	1SAM250000R1009	0.265
4.0	6.30 ... 10.0	50	150	MS116-10	1SAM250000R1010	0.265
5.5	8.00 ... 12.0	25	180	MS116-12	1SAM250000R1012	0.265
7.5	10.0 ... 16.0	16	240	MS116-16	1SAM250000R1011	0.265
9.0	16.0 ... 20.0	10	300	MS116-20	1SAM250000R1013	0.310
12.5	20.0 ... 25.0	10	375	MS116-25	1SAM250000R1014	0.310
15.5	25.0 ... 32.0	10	480	MS116-32	1SAM250000R1015	0.310
0.03	0.10 ... 0.16	50	1.56	MS116-0.16-HKF1-11	1SAM250005R1001	0.240
0.06	0.16 ... 0.25	50	2.44	MS116-0.25-HKF1-11	1SAM250005R1002	0.240
0.09	0.25 ... 0.40	50	3.90	MS116-0.4-HKF1-11	1SAM250005R1003	0.240
0.12	0.40 ... 0.63	50	6.14	MS116-0.63-HKF1-11	1SAM250005R1004	0.240
0.25	0.63 ... 1.00	50	11.50	MS116-1.0-HKF1-11	1SAM250005R1005	0.240
0.55	1.00 ... 1.60	50	18.40	MS116-1.6-HKF1-11	1SAM250005R1006	0.280
0.75	1.60 ... 2.50	50	28.75	MS116-2.5-HKF1-11	1SAM250005R1007	0.280
1.5	2.50 ... 4.00	50	50.00	MS116-4.0-HKF1-11	1SAM250005R1008	0.280
2.2	4.00 ... 6.30	50	78.75	MS116-6.3-HKF1-11	1SAM250005R1009	0.280
4.0	6.30 ... 10.0	50	150	MS116-10.0-HKF1-11	1SAM250005R1010	0.280
5.5	8.00 ... 12.0	25	180	MS116-12.0-HKF1-11	1SAM250005R1012	0.280
7.5	10.0 ... 16.0	16	240	MS116-16.0-HKF1-11	1SAM250005R1011	0.280
9.0	16.0 ... 20.0	10	300	MS116-20-HKF1-11	1SAM250005R1013	0.326
12.5	20.0 ... 25.0	10	375	MS116-25-HKF1-11	1SAM250005R1014	0.326
15.5	25.0 ... 32.0	10	480	MS116-32-HKF1-11	1SAM250005R1015	0.326

Main dimensions mm, inches

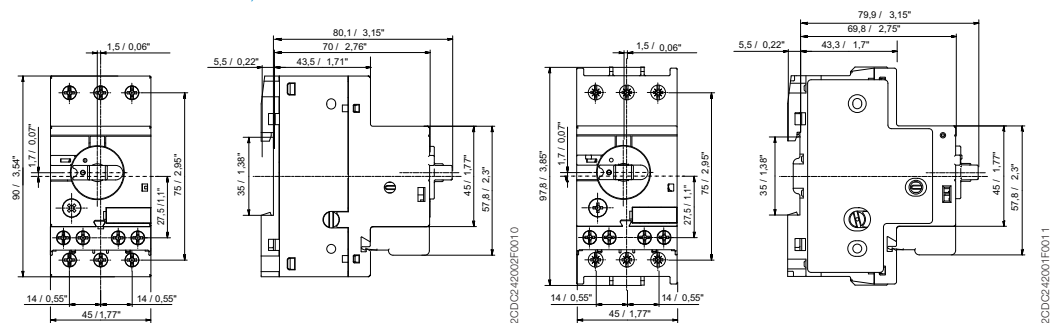

MS116 manual motor starters

Technical data

Main circuit – Utilization characteristics according to IEC/EN

Type	MS116
Standards	IEC/EN 60947-2, IEC/EN 60947-4-1, IEC/EN 60947-1
Rated operational voltage U_e	690 V AC
Rated frequency	50/60 Hz
Trip class	10A
Number of poles	3
Duty time	100 %
Rated impulse withstand voltage U_{imp}	6 kV
Rated insulation voltage U_i	690 V AC
Rated operational current I_e	See ordering details
Rated instantaneous short-circuit current setting I_i	See ordering details
Rated service short-circuit breaking capacity I_{cs}	See table "Short-circuit breaking capacity and back-up fuses"
Rated ultimate short-circuit breaking capacity I_{cu}	See table "Short-circuit breaking capacity and back-up fuses"

Short-circuit breaking capacity and back-up fuses

I_{cs} Rated service short-circuit breaking capacity

I_{cu} Rated ultimate short-circuit breaking capacity

I_{cc} Prospective short-circuit current at installation location

Note: Maximum rated current of the back-up fuses if $I_{cc} > I_{cs}$

Type	230 V AC			400 V AC			440 V AC			500 V AC			690 V AC		
	I_{cs} kA	I_{cu} kA	gG, aM A	I_{cs} kA	I_{cu} kA	gG, aM A	I_{cs} kA	I_{cu} kA	gG, aM A	I_{cs} kA	I_{cu} kA	gG, aM A	I_{cs} kA	I_{cu} kA	gG, aM A
MS116-0.16	No back-up fuse required up to $I_{cc} = 50$ kA														
MS116-0.25															
MS116-0.4															
MS116-0.63															
MS116-1.0															
MS116-1.6	No back-up fuse required up to $I_{cc} = 30$ kA														
MS116-2.5							10	10	25	10	10	25	5	5	25
MS116-4.0							6	6	25	6	6	25	2	2	25
MS116-6.3							6	6	63	6	6	63	2	2	40
MS116-10							6	6	63	6	6	63	2	2	50
MS116-12	25	25	80	25	25	80	6	6	63	6	6	63	2	2	50
MS116-16	16	16	80	16	16	80	6	6	63	4	4	63	2	2	63
MS116-20	10	15	-	10	15	-	3	6	-	3	4	-	2	2	-
MS116-25	10	15	-	10	15	-	3	6	-	3	4	-	2	2	-
MS116-32	10	10	-	10	10	-	3	6	-	3	4	-	2	2	-

MS116-10: No need for back-up fuse in networks with a prospective current of up to 50 kA at 400 V.

MS116-16: No need for back-up fuse in networks with a prospective current of up to 16 kA at 400 V.

With an appropriate 80 A type gG fuse the device can be used in a network with a prospective current of up to 100 kA.

MS116-32: No need for back-up fuse in networks with a prospective current of up to 15 kA at 400 V.

MS116 manual motor starters

Technical data

Main circuit – Utilization characteristics according to UL/CSA

Type	MS116	
Standards	UL 508, CSA 22.2 No. 14	
Maximum operational voltage	600 V AC	
Manual motor controller ratings	See table "UL 508 – Manual motor controller"	
Trip rating	125 % FLA	
Motor ratings	Horse power	See table "Motor rating, three phase"
	Full load amps (FLA)	See table "Motor rating, three phase"
	Locked rotor amps (LRA)	See table "Motor rating, three phase"

Motor rating, three phase

hp Horse power

FLA Full load amps

LRA Locked rotor amps

Type	110-120 V AC			220-240 V AC			440-480 V AC			500-600 V AC		
	hp	FLA	LRA	hp	FLA	LRA	hp	FLA	LRA	hp	FLA	LRA
MS116-0.16	-	0.16	0.96	-	0.16	0.96	-	0.16	0.96	-	0.16	0.96
MS116-0.25	-	0.25	1.5	-	0.25	1.5	-	0.25	1.5	-	0.25	1.5
MS116-0.4	-	0.4	2.4	-	0.4	2.4	-	0.4	2.4	-	0.4	2.4
MS116-0.63	-	0.63	3.78	-	0.63	3.78	-	0.63	3.78	-	0.63	3.78
MS116-1.0	-	1.0	6.0	-	1.0	6.0	-	1.0	6.0	1/2	0.9	8
MS116-1.6	-	1.6	9.6	-	1.6	9.6	3/4	1.6	12.5	3/4	1.3	10
MS116-2.5	-	2.5	15.0	1/2	2.2	20	1	2.1	15	1-1/2	2.4	16
MS116-4.0	-	4.0	16.0	1	4.2	30	2	3.4	25	3	3.9	25.6
MS116-6.3	1/2	4.4	40	1-1/2	6.4	40	3	4.8	32	5	6.1	36.8
MS116-10	1	8.4	60	3	9.6	64	5	7.6	46	7-1/2	9	50.8
MS116-12	1-1/2	12	80	3	9.6	64	7-1/2	11	63.5	10	11	64.8
MS116-16	2	13.6	100	5	15.2	92	10	14	81	10	11	64.8
MS116-20	3	19.2	128	5	15.2	92	10	14	81	15	17	93
MS116-25	3	19.2	128	7-1/2	22	127	15	21	116	20	22	116
MS116-32	5	30.4	184	10	28	162	20	27	145	25	27	146

UL 508 – Manual motor controller

Type	Maximum fuse type K5 o. RK5 per UL/NEC 480 V / 600 V A	Maximum short-circuit current for motor disconnect ¹⁾			
		480 V		600 V	
		kA	kA	kA	kA
MS116-0.16	100	30	5	18	5
MS116-0.25	100	30	5	18	5
MS116-0.4	100	30	5	18	5
MS116-0.63	100	30	5	18	5
MS116-1.0	100	30	5	18	5
MS116-1.6	100	30	5	18	5
MS116-2.5	100	30	5	18	5
MS116-4.0	100	18	5	18	5
MS116-6.3	100	18	5	18	5
MS116-10	100	18	5	18	5
MS116-12	100	18	5	18	5
MS116-16	100	18	5	18	5
MS116-20	100	18	5	18	5
MS116-25	100	18	5	18	5
MS116-32	100	18	5	18	5

¹⁾ Suitable as motor disconnect only when provided with padlock SA1 or SA3...



MS116 manual motor starters

Technical data

General technical data

Type	MS116	
Pollution degree	3	
Phase loss sensitive	Yes	
Ambient air temperature		
Operation	Open - compensated without derating	-25 ... +55 °C
	Open	-25 ... +70 °C
	Enclosed (IB132)	0 ... +40 °C
Storage	-50 ... +80 °C	
Ambient air temperature compensation	Continuous	
Maximum operating altitude permissible	2000 m	
Resistance to shock acc. to IEC 60068-2-27	25 g / 11 ms	
Resistance to vibrations acc. to IEC 60068-2-6	5 g / 3 ... 150 Hz	
Mounting position	Position 1-6 (optional for single mounting)	
Mounting	DIN-rail (EN 60715)	
Group mounting	On request	
Minimum distance to other units same type	Horizontal	0 mm
	Vertical	150 mm
Minimum distance to electrical conductive board	Horizontal, up to 400 V	0 mm
	Horizontal, up to 690 V	> 1.5 mm
	Vertical	75 mm
Degree of protection	Enclosure / terminals	IP20

Connecting characteristics

Main circuit		MS116 ≤ 16 A	MS116 ≥ 20 A
Type			
Connecting capacity			
 Solid	1 or 2 x	1 ... 4 mm ²	2.5 ... 6 mm ²
 Flexible	1 or 2 x	0.75 ... 2.5 mm ²	1 ... 6 mm ²
	Stranded acc. to UL/CSA	1 or 2 x AWG 16-12	AWG 12-8
	Flexible acc. to UL/CSA	1 or 2 x AWG 16-12	AWG 12-8
Stripping length		9 mm	10 mm
Tightening torques		0.8 ... 1.2 Nm / 10 ... 12 lb.in	2.0 Nm / 18 lb.in
Connection screw		M3.5 (Pozidriv 2 / 5.5 mm)	M4 (Pozidriv 2 / 6.5 mm)

MS116 manual motor starters

Main accessories

2

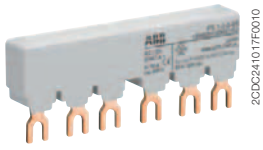

PS1-2-0-65

2CDC241017F0010

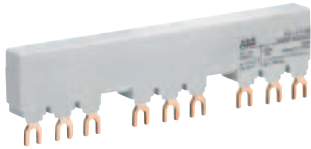

PS1-3-1-100

2CDC241014F0010

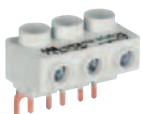

S1-M1-25

1SBC101226F0014



S1-M2-25

1SBC101266F0014



SA1

SK1038B01

Description

Three-phase busbars ensure a quick and safe connection and are therefore a cost effective solution. A variety of different three-phase busbars up to 100 A are in the assortment. Between 2 and 5 manual motor starters with none, one or two lateral auxiliary contacts can be connected. Different three-phase feeder terminals are available according to the application.

Ordering details

Rated operational current A	Number of MMS	Number of lateral aux.	Type	Order code	Pkg qty	Weight (1 pce) kg
Three-phase busbars						
65	2	0	PS1-2-0-65	1SAM201906R1102	10	0.034
65	3	0	PS1-3-0-65	1SAM201906R1103	10	0.055
65	4	0	PS1-4-0-65	1SAM201906R1104	10	0.077
65	5	0	PS1-5-0-65	1SAM201906R1105	10	0.098
65	2	1	PS1-2-1-65	1SAM201906R1112	10	0.036
65	3	1	PS1-3-1-65	1SAM201906R1113	10	0.060
65	4	1	PS1-4-1-65	1SAM201906R1114	10	0.087
65	5	1	PS1-5-1-65	1SAM201906R1115	10	0.108
65	2	2	PS1-2-2-65	1SAM201906R1122	10	0.040
65	3	2	PS1-3-2-65	1SAM201906R1123	10	0.067
65	4	2	PS1-4-2-65	1SAM201906R1124	10	0.095
65	5	2	PS1-5-2-65	1SAM201906R1125	10	0.122
100	3	0	PS1-3-0-100	1SAM201916R1103	10	0.084
100	4	0	PS1-4-0-100	1SAM201916R1104	10	0.117
100	5	0	PS1-5-0-100	1SAM201916R1105	10	0.154
100	3	1	PS1-3-1-100	1SAM201916R1113	10	0.094
100	4	1	PS1-4-1-100	1SAM201916R1114	10	0.134
100	5	1	PS1-5-1-100	1SAM201916R1115	10	0.172
100	3	2	PS1-3-2-100	1SAM201916R1123	10	0.105

Rated operational current A	Rated cross section mm ²	Mounting form	Type	Order code	Pkg qty	Weight (1 pce) kg
Three-phase feeder terminals						
65	25	Flat	S1-M1-25	1SAM201907R1101	10	0.038
65	25	High	S1-M2-25	1SAM201907R1102	10	0.051
65	25	UL type E and IEC	S1-M3-25	1SAM201907R1103	10	0.042
100	35	UL type E and IEC	S1-M3-35	1SAM201913R1103	10	0.060

Description	Type	Order code	Pkg qty	Weight (1 pce) kg
Protection cover for busbars	BS1-3	1SAM201908R1001	50	0.003
Lock handle	SA1	GJF1101903R0001	10	0.003
Padlock	SA2	GJF1101903R0002	10	0.020
Lock handle box SA1/SA2	SA3	GJF1101903R0003	10	0.050
Screw fixing kit	FS116	1SAM201909R1001	1	0.020

MS116 manual motor starters

Main accessories



HKF1-11

1SBC101208F0014



HK1-11

1SBC101209F0014



SK1-11

1SBC101210F0014



AA1-24

1SBC101211F0014



UA1-24

1SBC101212F0014

Description

MS116 manual motor starters can be equipped with auxiliary contacts for lateral/front mounting, signalling contact for lateral mounting, undervoltage release and shunt trips. The accessories can be fitted wiring free and without tools. A variety of combinations is possible as required for the application. The auxiliary contacts change position with the main contacts. The signalling contact signals tripping regardless if it was caused by short-circuit or overload. Undervoltage release are used for remote tripping of the manual motor starter especially for emergency stop circuits. Shunt trips release the MMS used for remote tripping.

Ordering details

Auxiliary contacts: N.O.	Auxiliary contacts: N.C.	Description	Type	Order code	Pkg qty	Weight (1 pce)
--------------------------	--------------------------	-------------	------	------------	---------	----------------

Auxiliary contacts – mountable on the front

1	1		HKF1-11	1SAM201901R1001	10	0.015
---	---	--	---------	-----------------	----	-------

Auxiliary contacts – mountable on the right

1	1	max. 2 pieces	HK1-11	1SAM201902R1001	2	0.035
2	0	max. 2 pieces	HK1-20	1SAM201902R1002	2	0.035
0	2	max. 2 pieces	HK1-02	1SAM201902R1003	2	0.035
2	0	with lead contacts	HK1-20L	1SAM201902R1004	2	0.035

Signalling contacts – mountable on the right

1	1	for tripped alarm, max. 2 pieces	SK1-11	1SAM201903R1001	2	0.035
2	0	for tripped alarm, max. 2 pieces	SK1-20	1SAM201903R1002	2	0.035
0	2	for tripped alarm, max. 2 pieces	SK1-02	1SAM201903R1003	2	0.035

Rated control supply voltage	Frequency	Type	Order code	Pkg qty	Weight (1 pce)
V	Hz				kg

Shunt trip units – mountable on the left

24	50/60	AA1-24	1SAM201910R1001	1	0.100
110	50/60	AA1-110	1SAM201910R1002	1	0.100
200 ... 240	50/60	AA1-230	1SAM201910R1003	1	0.100
350 ... 415	50/60	AA1-400	1SAM201910R1004	1	0.100

Undervoltage releases – mountable on the left

24	50	UA1-24	1SAM201904R1001	1	0.100
48	50	UA1-48	1SAM201904R1002	1	0.100
60	50	UA1-60	1SAM201904R1003	1	0.100
110 ... 120	50/60	UA1-120	1SAM201904R1004	1	0.100
208	60	UA1-208	1SAM201904R1005	1	0.100
230 ... 240	50/60	UA1-230	1SAM201904R1006	1	0.100
400	50	UA1-400	1SAM201904R1007	1	0.100
415 ... 480	50/60	UA1-415	1SAM201904R1008	1	0.100

MS116 manual motor starters

Main accessories

2



2CDC24100FF0010

IB132-Y



2CDC24100BF0010

IB132-G



2CDC24100FF0010

DMS132-Y



2CDC24100BF0010

DMS132-G

Description

IB132 are IP65 enclosures for single MMS installation. Additional mounting of auxiliary and signalling contacts, shunt trips and undervoltage release is possible. The handle is lockable in OFF position. For detailed specification see installation instruction.

DMS132 are IP65 door mounting kits for MMS installation in any enclosure. Additional mounting of auxiliary, signalling, shunt trips and undervoltage release is possible. The handle is lockable in OFF position. For detailed specification see installation instruction.

Ordering details

Description	Color	Type	Order code	Pkg qty	Weight (1 pce) kg
Enclosures IP65					
Padlockable max. 3 padlocks with bail diameter 4 ... 6.5 mm	Yellow/red	IB132-Y	1SAM201911R1011	1	0.370
	Grey/black	IB132-G	1SAM201911R1010	1	0.370
Door mounting kit IP65					
Padlockable max. 3 padlocks with bail diameter 4 ... 6.5 mm	Yellow/red	DMS132-Y	1SAM201912R1011	1	0.170
	Grey/black	DMS132-G	1SAM201912R1010	1	0.170

Indication I-O-T and ON-OFF-T

Main dimensions mm, inches

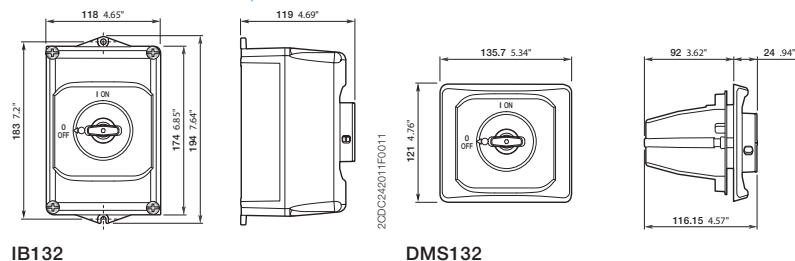

MS116 manual motor starters

Main accessories



2CDC241003F0011

MSHD-LB



2CDC241002S0011

MSHD-LY



2CDC241004S0011

MSMN

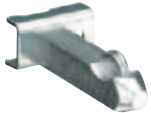

2CDC241005S0011

MSOX-30

Description

The complete set includes handle, shaft and driver. All accessories fit 6 mm shafts of maximum 180 mm length. The degree of protection for handles MSHD is IP64.

Ordering details

Description	Shaft length mm	Type	Order code	Pkg qty	Weight (1 pce) kg
-------------	--------------------	------	------------	------------	-------------------------

Shafts

For selector type handles. Shaft diameter 6 mm. Shaft extension for door coupling driver.	85	OXS6X85	1SCA101647R1001	1	0.020
	105	OXS6X105	1SCA108043R1001	1	0.020
	130	OXS6X130	1SCA101655R1001	1	0.030
	180	OXS6X180	1SCA101659R1001	1	0.040

Description	Color	Type	Order code	Pkg qty	Weight (1 pce) kg
-------------	-------	------	------------	------------	-------------------------

Selector type handles IP64

Padlockable max. 3 padlocks with bail diameter 5 ... 8 mm, door interlock in ON position defeatable, for use with 6 mm OXS6...types up to 180 mm or driver shafts MSOX.	Black	MSHD-LB ¹⁾	1SAM201920R1001	1	0.065
	Yellow	MSHD-LY	1SAM201920R1002	1	0.065

¹⁾ Indication I-O and ON-OFF

Description	Type	Order code	Pkg qty	Weight (1 pce) kg
-------------	------	------------	------------	-------------------------

Driver

Coupling driver for use with 6 mm OXS6... types up to 180 mm.	MSMN ¹⁾	1SAM101923R0002	1	0.002
	MSMNO ²⁾	1SAM101923R0012	1	0.002

¹⁾ Coded - Positioning of ON indication dependent from mounting orientation of the MS

²⁾ Uncoded - Positioning of ON indication independent from mounting orientation of the MS

Description	Shaft length mm	Type	Order code	Pkg qty	Weight (1 pce) kg
-------------	--------------------	------	------------	------------	-------------------------

Driver shafts

Driver shaft - combination driver & shaft. Shaft diameter 6 mm.	32	MSOX-32 ¹⁾	1SAM101924R0003	1	0.010
	30	MSOX-30 ²⁾	1SAM101924R0013	1	0.010

¹⁾ MSOX-32 is for normal vertical use

²⁾ MSOX-30 is for horizontal use

MS132 manual motor starters

0.10 to 32 A – with thermal and electromagnetic protection

2



MS132-10

1SBC101232F0010



MS132-32

2CDC241001F0011



MS132-0.16-HKF1-11

2CDC241014F0011



MS132-32-HKF1-11

2CDC241015F0011

Description

Manual motor starters (MMS) are protection devices for the main circuit. They combine motor control and protection in a single device. MMS are used mainly to switch motors manually ON/OFF and protect them and the installation fuse less against short-circuit, overload and phase failures. Fuse less protection with a manual motor starter saves costs, space and ensures a quick reaction under short-circuit condition, by switching off the motor within milliseconds.

MS132 is a compact and powerful range for motor protection up to 15 kW (400 V) / 32 A in width of 45 mm. Further features are the built-in disconnect function, temperature compensation, trip-free mechanism and a rotary handle with a clear switch position indication. The manual motor starter is suitable for three- and single-phase applications. The handle is lockable to protect against unauthorized changes. Auxiliary contacts, signalling contacts, undervoltage releases, shunt trips, three-phase bus bars, power in-feed blocks.

Ordering details

Rated operational power 400 V AC-3	Setting range	Short-circuit breaking capacity I_{cs} at 400 V AC	Rated instantaneous short-circuit current setting I_i	Type	Order code	Weight (1 pce)
kW	A	kA	A			kg
0.03	0.10 ... 0.16	100	1.56	MS132-0.16	1SAM350000R1001	0.215
0.06	0.16 ... 0.25	100	2.44	MS132-0.25	1SAM350000R1002	0.215
0.09	0.25 ... 0.40	100	3.90	MS132-0.4	1SAM350000R1003	0.215
0.12	0.40 ... 0.63	100	6.14	MS132-0.63	1SAM350000R1004	0.215
0.25	0.63 ... 1.00	100	11.50	MS132-1.0	1SAM350000R1005	0.215
0.55	1.00 ... 1.60	100	18.40	MS132-1.6	1SAM350000R1006	0.265
0.75	1.60 ... 2.50	100	28.75	MS132-2.5	1SAM350000R1007	0.265
1.5	2.50 ... 4.00	100	50.00	MS132-4.0	1SAM350000R1008	0.265
2.2	4.00 ... 6.30	100	78.75	MS132-6.3	1SAM350000R1009	0.265
4.0	6.30 ... 10.0	100	150	MS132-10	1SAM350000R1010	0.265
5.5	8.00 ... 12.0	100	180	MS132-12	1SAM350000R1012	0.310
7.5	10.0 ... 16.0	100	240	MS132-16	1SAM350000R1011	0.310
9.0	16.0 ... 20.0	100	300	MS132-20	1SAM350000R1013	0.310
12.5	20.0 ... 25.0	50	375	MS132-25	1SAM350000R1014	0.310
15.5	25.0 ... 32.0	25	480	MS132-32	1SAM350000R1015	0.310
0.03	0.10 ... 0.16	100	1.56	MS132-0.16-HKF1-11	1SAM350005R1001	0.231
0.06	0.16 ... 0.25	100	2.44	MS132-0.25-HKF1-11	1SAM350005R1002	0.231
0.09	0.25 ... 0.40	100	3.90	MS132-0.4-HKF1-11	1SAM350005R1003	0.231
0.12	0.40 ... 0.63	100	6.14	MS132-0.63-HKF1-11	1SAM350005R1004	0.231
0.25	0.63 ... 1.00	100	11.50	MS132-1.0-HKF1-11	1SAM350005R1005	0.231
0.55	1.00 ... 1.60	100	18.40	MS132-1.6-HKF1-11	1SAM350005R1006	0.281
0.75	1.60 ... 2.50	100	28.75	MS132-2.5-HKF1-11	1SAM350005R1007	0.281
1.5	2.50 ... 4.00	100	50.00	MS132-4.0-HKF1-11	1SAM350005R1008	0.281
2.2	4.00 ... 6.30	100	78.75	MS132-6.3-HKF1-11	1SAM350005R1009	0.281
4.0	6.30 ... 10.0	100	150	MS132-10.0-HKF1-11	1SAM350005R1010	0.281
5.5	8.00 ... 12.0	100	180	MS132-12.0-HKF1-11	1SAM350005R1012	0.326
7.5	10.0 ... 16.0	100	240	MS132-16.0-HKF1-11	1SAM350005R1011	0.326
9.0	16.0 ... 20.0	100	300	MS132-20-HKF1-11	1SAM350005R1013	0.326
12.5	20.0 ... 25.0	50	375	MS132-25-HKF1-11	1SAM350005R1014	0.326
15.5	25.0 ... 32.0	25	480	MS132-32-HKF1-11	1SAM350005R1015	0.326

Main dimensions mm, inches

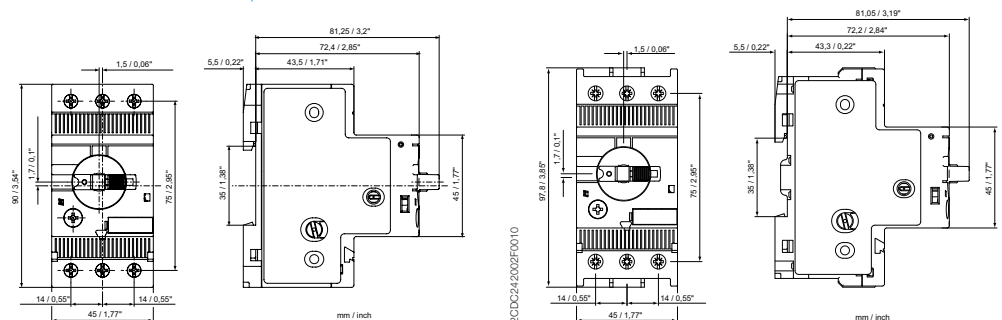

MS132 manual motor starters

Technical data

Main circuit – Utilization characteristics according to IEC/EN

Type	MS132
Standards	IEC/EN 60947-2, IEC/EN 60947-4-1, IEC/EN 60947-1
Rated operational voltage U_e	690 V AC / 250 V DC
Rated frequency	DC, 50/60 Hz
Trip class	10 (10A for 1SAM350000R1001)
Number of poles	3
Duty time	100 %
Rated impulse withstand voltage U_{imp}	6 kV
Rated insulation voltage U_i	690 V AC
Rated operational current I_e	See ordering details
Rated instantaneous short-circuit current setting I_i	See ordering details
Rated service short-circuit breaking capacity I_{cs}	See table "Short-circuit breaking capacity and back-up fuses"
Rated ultimate short-circuit breaking capacity I_{cu}	See table "Short-circuit breaking capacity and back-up fuses"

Short-circuit breaking capacity and back-up fuses

I_{cs} Rated service short-circuit breaking capacity

I_{cu} Rated ultimate short-circuit breaking capacity

I_{cc} Prospective short-circuit current at installation location

Note: Maximum rated current of the back-up fuses if $I_{cc} > I_{cs}$

Type	230 V AC			400 V AC			440 V AC			500 V AC			690 V AC		
	I_{cs} kA	I_{cu} kA	gG, aM A	I_{cs} kA	I_{cu} kA	gG, aM A	I_{cs} kA	I_{cu} kA	gG, aM A	I_{cs} kA	I_{cu} kA	gG, aM A	I_{cs} kA	I_{cu} kA	gG, aM A
MS132-0.16															
MS132-0.25															
MS132-0.4															
MS132-0.63															
MS132-1.0	No back-up fuse required up to														
MS132-1.6	I _{cc} = 100 kA														
MS132-2.5															
MS132-4.0							20	20	*	20	20	*	3	3	*
MS132-6.3							20	20	*	20	20	*	3	3	*
MS132-10							20	20	*	20	20	*	3	3	*
MS132-12							20	20	*	20	20	*	3	3	*
MS132-16							20	20	*	20	20	*	3	3	*
MS132-20							20	20	*	20	20	*	3	3	*
MS132-25	50	50	100	50	50	100	20	20	*	10	10	*	3	3	*
MS132-32	25	50	125	25	50	125	20	20	*	10	10	*	3	3	*

MS132-16: No need for back-up fuse in networks with a prospective current of up to 100 kA at 400 V.

MS132-32: No need for back-up fuse in networks with a prospective current of up to 50 kA at 400 V.

With an appropriate 125 A type gG fuse the device can be used in a network with a prospective current of up to 100 kA

* not available yet

MS132 manual motor starters

Technical data

Main circuit – Utilization characteristics according to UL/CSA

Type	MS132	
Standards	UL 508, CSA 22.2 No. 14	
Maximum operational voltage	600 V AC	
Manual motor controller ratings	See table "UL 508 – Manual motor controller"	
Trip rating	125 % FLA	
Motor ratings	Horse power	See table "Motor rating, three phase"
	Full load amps (FLA)	See table "Motor rating, three phase"
	Locked rotor amps (LRA)	See table "Motor rating, three phase"

Motor rating, three phase

hp Horse power

FLA Full load amps

LRA Locked rotor amps

Type	110-120 V AC			220-240 V AC			440-480 V AC			500-600 V AC		
	hp	FLA	LRA	hp	FLA	LRA	hp	FLA	LRA	hp	FLA	LRA
MS132-0.16	-	0.16	0.96	-	0.16	0.96	-	0.16	0.96	-	0.16	0.96
MS132-0.25	-	0.25	1.5	-	0.25	1.5	-	0.25	1.5	-	0.25	1.5
MS132-0.4	-	0.4	2.4	-	0.4	2.4	-	0.4	2.4	-	0.4	2.4
MS132-0.63	-	0.63	3.78	-	0.63	3.78	-	0.63	3.78	-	0.63	3.78
MS132-1.0	-	1.0	6.0	-	1.0	6.0	-	1.0	6.0	1/2	1.0	6.0
MS132-1.6	-	1.6	9.6	-	1.6	9.6	3/4	1.6	9.6	3/4	1.6	9.6
MS132-2.5	-	2.5	15.0	1/2	2.5	15.0	1	2.5	15.0	1-1/2	2.5	15.0
MS132-4.0	-	4.0	24.0	1	4.0	24.0	2	4.0	24.0	3	3.9	26.0
MS132-6.3	1/2	6.3	37.8	1-1/2	6.3	37.8	3	4.8	32.0	5	6.1	37.0
MS132-10	3/4	10.0	60.0	3	9.6	64.0	5	7.6	46.0	7-1/2	9.0	51.0
MS132-12	1-1/2	12.0	72.0	3	9.6	64.0	7-1/2	11.0	64.0	10	11.0	65.0
MS132-16	2	16.0	84.0	5	15.2	92.0	10	14.0	81.0	10	11.0	65.0
MS132-20	3	19.2	128.0	5	15.2	92.0	10	14.0	81.0	15	17.0	93.0
MS132-25	3	19.2	128.0	7-1/2	22.0	127.0	15	21.0	116.0	20	22.0	116.0
MS132-32	5	30.4	184.0	10	28.0	162.0	20	27.0	145.0	25	27.0	146.0

UL 508 – Manual motor controller

Type	Maximum short-circuit current for motor disconnect ¹⁾		for group installation		for self-protected combination motor controller (type E) in combination with feeder block S1-M3-xx		for tap conductor protection	
	480 V	600 V	480 V	600 V	480Y / 277 V	600Y / 347 V	480 V	600 V
	kA	kA	kA	kA	kA	kA	kA	kA
MS132-0.16	65	47	65	47	65	47	65	47
MS132-0.25	65	47	65	47	65	47	65	47
MS132-0.4	65	47	65	47	65	47	65	47
MS132-0.63	65	47	65	47	65	47	65	47
MS132-1.0	65	47	65	47	65	47	65	47
MS132-1.6	65	47	65	47	65	47	65	47
MS132-2.5	65	47	65	47	65	47	65	47
MS132-4.0	65	18	65	30	65	18	65	18
MS132-6.3	65	18	65	30	65	-	65	18
MS132-10	65	18	65	30	65	-	65	18
MS132-12	30	18	30	30	30	-	30	18
MS132-16	30	18	30	30	30	-	30	18
MS132-20	30	18	30	30	30	-	30	18
MS132-25	30	18	30	30	30	-	30	18
MS132-32	30	18	30	30	30	-	30	18



MS132 manual motor starters

Technical data

General technical data

Type	MS132	
Pollution degree	3	
Phase loss sensitive	Yes	
Ambient air temperature		
Operation	Open - compensated without derating	-25 ... +60 °C
	Open	-25 ... +70 °C
	Enclosed (IB132)	0 ... +40 °C
Storage	-50 ... +80 °C	
Ambient air temperature compensation	Continuous	
Maximum operating altitude permissible	2000 m	
Resistance to shock acc. to IEC 60068-2-27	25 g / 11 ms	
Resistance to vibrations acc. to IEC 60068-2-6	5 g / 3 ... 150 Hz	
Mounting position	Position 1-6 (optional for single mounting)	
Mounting	DIN-rail (EN 60715)	
Group mounting	On request	
Minimum distance to other units same type	Horizontal	0 mm
	Vertical	150 mm
Minimum distance to electrical conductive board	Horizontal, up to 400 V	0 mm
	Horizontal, up to 690 V	> 1.5 mm
	Vertical	75 mm
Degree of protection	Enclosure / terminals	IP20

Connecting characteristics

Main circuit		MS132-016 ... MS132-10	MS132-12 ... MS132-16	MS132-20 ... MS132-32
Type				
Connecting capacity				
 Solid	1 or 2 x	1 ... 4 mm ²	1 ... 4 mm ²	2.5 ... 6 mm ²
 Flexible	1 or 2 x	0.75 ... 2.5 mm ²	0.75 ... 2.5 mm ²	1 ... 6 mm ²
	Stranded acc. to UL/CSA	1 or 2 x AWG 16-12	AWG 16-12	AWG 12-8
	Flexible acc. to UL/CSA	1 or 2 x AWG 16-12	AWG 16-12	AWG 12-8
Stripping length		9 mm	10 mm	10 mm
Tightening torques		0.8 ... 1.2 Nm / 10 ... 12 lb.in	1.5 Nm / 14 lb.in	2.0 Nm / 18 lb.in
Connection screw		M3.5 (Pozi driv 2)	M4 (Pozi driv 2)	M4 (Pozi driv 2)

MS132 manual motor starters

Main accessories

2

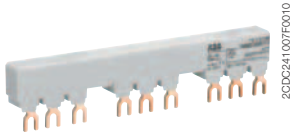

PS1-3-1-65

2CDC241007F0010

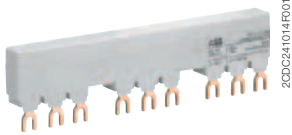

PS1-3-1-100

2CDC241014R0010

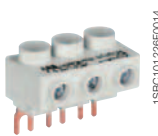

S1-M1-25

1SBC10126FF0014



S1-M2-25

1SBC10126FF0014

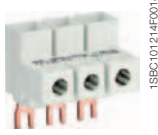

S1-M3-25

1SBC101214F0014



SA2

SK0108B91

Description

Three-phase busbars ensure a quick and safe connection and are therefore a cost effective solution. A variety of different three-phase busbars up to 100 A are in the assortment. Between 2 and 5 manual motor starters with none, one or two lateral auxiliary contacts can be connected. Different three-phase feeder terminals are available according to the application.

Ordering details

Rated operational current A	Number of MMS	Number of lateral aux.	Type	Order code	Pkg qty	Weight (1 pce) kg
Three-phase busbars						
65	2	0	PS1-2-0-65	1SAM201906R1102	10	0.034
65	3	0	PS1-3-0-65	1SAM201906R1103	10	0.055
65	4	0	PS1-4-0-65	1SAM201906R1104	10	0.077
65	5	0	PS1-5-0-65	1SAM201906R1105	10	0.098
65	2	1	PS1-2-1-65	1SAM201906R1112	10	0.036
65	3	1	PS1-3-1-65	1SAM201906R1113	10	0.060
65	4	1	PS1-4-1-65	1SAM201906R1114	10	0.087
65	5	1	PS1-5-1-65	1SAM201906R1115	10	0.108
65	2	2	PS1-2-2-65	1SAM201906R1122	10	0.040
65	3	2	PS1-3-2-65	1SAM201906R1123	10	0.067
65	4	2	PS1-4-2-65	1SAM201906R1124	10	0.095
65	5	2	PS1-5-2-65	1SAM201906R1125	10	0.122
100	3	0	PS1-3-0-100	1SAM201916R1103	10	0.084
100	4	0	PS1-4-0-100	1SAM201916R1104	10	0.117
100	5	0	PS1-5-0-100	1SAM201916R1105	10	0.154
100	3	1	PS1-3-1-100	1SAM201916R1113	10	0.094
100	4	1	PS1-4-1-100	1SAM201916R1114	10	0.134
100	5	1	PS1-5-1-100	1SAM201916R1115	10	0.172
100	3	2	PS1-3-2-100	1SAM201916R1123	10	0.105

Rated operational current A	Rated cross section mm ²	Mounting form	Type	Order code	Pkg qty	Weight (1 pce) kg
Three-phase feeder terminals						
65	25	Flat	S1-M1-25	1SAM201907R1101	10	0.038
65	25	High	S1-M2-25	1SAM201907R1102	10	0.051
65	25	UL type E and IEC	S1-M3-25	1SAM201907R1103	10	0.042
100	35	UL type E and IEC	S1-M3-35	1SAM201913R1103	10	0.060

Description	Type	Order code	Pkg qty	Weight (1 pce) kg
Protection cover for busbars	BS1-3	1SAM201908R1001	50	0.003
Padlock	SA2	GJF1101903R0002	10	0.020
Screw fixing kit	FS116	1SAM201909R1001	1	0.020

MS132 manual motor starters

Main accessories



HKF1-11

1SBC101208F0014



HK1-11

1SBC101209F0014



SK1-11

1SBC101210F0014



CK1-11

1SBC101286F0014



AA1-24

1SBC101211F0014



UA1-24

1SBC101212F0014

Description

MS132 manual motor starters can be equipped with auxiliary contacts for lateral/front mounting, signalling contact for lateral mounting, undervoltage release and shunt trips. Two different signalling contacts are available. The accessories can be fitted wiring free and without tools. A variety of combinations is possible as required for the application. The auxiliary contacts change position with the main contacts. The signalling contact SK signals tripping regardless if it was caused by short-circuit or overload. The signalling contact CK signals tripping in case it was caused by short-circuit. Undervoltage release are used for remote tripping of the manual motor starter especially for emergency stop circuits. Shunt trips release the MMS used for remote tripping.

Ordering details

Auxiliary contacts: N.O.	Auxiliary contacts: N.C.	Description	Type	Order code	Pkg qty	Weight (1 pce) kg
--------------------------	--------------------------	-------------	------	------------	---------	-------------------

Auxiliary contacts – mountable on the front

1	1		HKF1-11	1SAM201901R1001	10	0.015
---	---	--	---------	-----------------	----	-------

Auxiliary contacts – mountable on the right

1	1	max. 2 pieces	HK1-11	1SAM201902R1001	2	0.035
2	0	max. 2 pieces	HK1-20	1SAM201902R1002	2	0.035
0	2	max. 2 pieces	HK1-02	1SAM201902R1003	2	0.035
2	0	with lead contacts	HK1-20L	1SAM201902R1004	2	0.035

Signalling contacts – mountable on the right

1	1	for tripped alarm, max. 2 pieces	SK1-11	1SAM201903R1001	2	0.035
2	0	for tripped alarm, max. 2 pieces	SK1-20	1SAM201903R1002	2	0.035
0	2	for tripped alarm, max. 2 pieces	SK1-02	1SAM201903R1003	2	0.035
1	1	for short-circuit alarm, max. 2 pieces	CK1-11	1SAM301901R1001	2	0.035
2	0	for short-circuit alarm, max. 2 pieces	CK1-20	1SAM301901R1002	2	0.035
0	2	for short-circuit alarm, max. 2 pieces	CK1-02	1SAM301901R1003	2	0.035

Rated control supply voltage	Frequency	Type	Order code	Pkg qty	Weight (1 pce) kg
V	Hz				kg

Shunt trip units – mountable on the left

24	50/60	AA1-24	1SAM201910R1001	1	0.100
110	50/60	AA1-110	1SAM201910R1002	1	0.100
200 ... 240	50/60	AA1-230	1SAM201910R1003	1	0.100
350 ... 415	50/60	AA1-400	1SAM201910R1004	1	0.100

Undervoltage releases – mountable on the left

24	50	UA1-24	1SAM201904R1001	1	0.100
48	50	UA1-48	1SAM201904R1002	1	0.100
60	50	UA1-60	1SAM201904R1003	1	0.100
110 ... 120	50/60	UA1-120	1SAM201904R1004	1	0.100
208	60	UA1-208	1SAM201904R1005	1	0.100
230 ... 240	50/60	UA1-230	1SAM201904R1006	1	0.100
400	50	UA1-400	1SAM201904R1007	1	0.100
415 ... 480	50/60	UA1-415	1SAM201904R1008	1	0.100

MS132 manual motor starters

Main accessories

2



IB132-Y



IB132-G



DMS132-Y



DMS132-G

Description

IB132 are IP65 enclosures for single MMS installation. Additional mounting of auxiliary and signalling contacts, shunt trips and undervoltage release is possible. The handle is lockable in OFF position. For detailed specification see installation instruction.

DMS132 are IP65 door mounting kits for MMS installation in any enclosure. Additional mounting of auxiliary, signalling, shunt trips and undervoltage release is possible. The handle is lockable in OFF position. For detailed specification see installation instruction.

Ordering details

Description	Colour	Type	Order code	Pkg qty	Weight (1 pce) kg
Enclosures IP65					
Padlockable max. 3 padlocks with bail diameter 4 ... 6.5 mm	Yellow/red	IB132-Y	1SAM201911R1011	1	0.370
	Grey/black	IB132-G	1SAM201911R1010	1	0.370
Door mounting kit IP65					
Padlockable max. 3 padlocks with bail diameter 4 ... 6.5 mm	Yellow/red	DMS132-Y	1SAM201912R1011	1	0.170
	Grey/black	DMS132-G	1SAM201912R1010	1	0.170

Indication I-O-T and ON-OFF-T

Main dimensions mm, inches

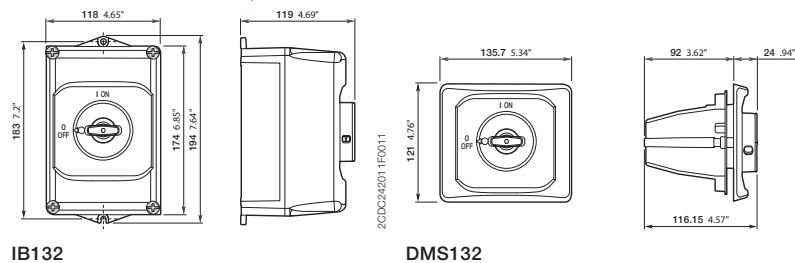

MS132 manual motor starters

Main accessories



MSHD-LTB

2CDC241007F0011



MSHD-LTY

2CDC241006F0011



MSMN

2CDC241004S0011

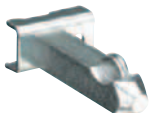

MSOX-30

2CDC241005S0011

Description

The complete set includes handle, shaft and driver. All accessories fit 6 mm shafts of maximum 180 mm length. The degree of protection for handles MSHD is IP64.

Ordering details

Description	Shaft length mm	Type	Order code	Pkg qty	Weight (1 pce) kg
-------------	--------------------	------	------------	------------	-------------------------

Shafts

For selector type handles. Shaft diameter 6 mm. Shaft extension for door coupling driver.

85	OXS6X85	1SCA101647R1001	1	0.020
105	OXS6X105	1SCA108043R1001	1	0.020
130	OXS6X130	1SCA101655R1001	1	0.030
180	OXS6X180	1SCA101659R1001	1	0.040

Description	Colour	Type	Order code	Pkg qty	Weight (1 pce) kg
-------------	--------	------	------------	------------	-------------------------

Selector type handles IP64

Padlockable max. 3 padlocks with bail diameter 5 ... 8 mm, door interlock in ON position defeatable, for use with 6 mm OXS6...types up to 180 mm or driver shafts MSOX.

Black	MSHD-LTB ¹⁾	1SAM201920R1011	1	0.065
Yellow	MSHD-LTY ¹⁾	1SAM201920R1012	1	0.065

¹⁾ Indication I-O-T and ON-OFF-T

Description	Type	Order code	Pkg qty	Weight (1 pce) kg
-------------	------	------------	------------	-------------------------

Driver

Coupling driver for use with 6 mm OXS6... types up to 180 mm.

MSMN ¹⁾	1SAM101923R0002	1	0.002
MSMNO ²⁾	1SAM101923R0012	1	0.002

¹⁾ Coded - Positioning of ON indication dependent from mounting orientation of the MS

²⁾ Uncoded - Positioning of ON indication independent from mounting orientation of the MS

Description	Shaft length mm	Type	Order code	Pkg qty	Weight (1 pce) kg
-------------	--------------------	------	------------	------------	-------------------------

Driver shafts

Driver shaft - combination driver & shaft. Shaft diameter 6 mm.

32	MSOX-32 ¹⁾	1SAM101924R0003	1	0.010
30	MSOX-30 ²⁾	1SAM101924R0013	1	0.010

¹⁾ MSOX-32 is for normal vertical use

²⁾ MSOX-30 is for horizontal use

MO132 manual motor starters magnetic only

0.10 to 32 A – with electromagnetic protection

2

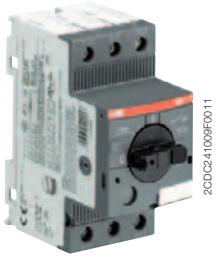

2CDC241008F0011

MO132-6.3

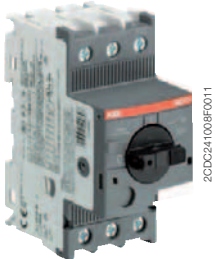

2CDC241008F0011

MO132-32

Description

Manual motor starters magnetic only are electromechanical protection devices for the main circuit. They are used mainly to switch motors manually ON/OFF and protect them fuse less against short-circuit.

Fuse less protection with a manual motor starter saves costs, space and ensures a quick reaction under short-circuit condition, by switching off the motor within milliseconds. Fuse less starter combinations are setup together with contactors and overload relays.

Ordering details

Rated operational power 400 V AC-3 ¹⁾ kW	Rated operational current A	Short-circuit breaking capacity I _{cs} at 400 V AC kA	Rated instantaneous short-circuit current setting I _i A	Type	Order code	Weight (1 pce) kg
0.03	0.16	100	1.56	MO132-0.16	1SAM360000R1001	0.215
0.06	0.25	100	2.44	MO132-0.25	1SAM360000R1002	0.215
0.09	0.40	100	3.90	MO132-0.4	1SAM360000R1003	0.215
0.12	0.63	100	6.14	MO132-0.63	1SAM360000R1004	0.215
0.25	1.0	100	11.50	MO132-1.0	1SAM360000R1005	0.215
0.55	1.6	100	18.40	MO132-1.6	1SAM360000R1006	0.265
0.75	2.5	100	28.75	MO132-2.5	1SAM360000R1007	0.265
1.5	4.0	50	50.00	MO132-4.0	1SAM360000R1008	0.265
2.2	6.3	50	78.75	MO132-6.3	1SAM360000R1009	0.265
4.0	10	50	125.00	MO132-10	1SAM360000R1010	0.265
5.5	12	50	150.00	MO132-12	1SAM360000R1012	0.310
7.5	16	50	200.00	MO132-16	1SAM360000R1011	0.310
9.0	20	50	250.00	MO132-20	1SAM360000R1013	0.310
12.5	25	50	313.00	MO132-25	1SAM360000R1014	0.310
15.5	32	25	400.00	MO132-32	1SAM360000R1015	0.310

¹⁾ For overload protection of motors, an appropriate thermal or electronic overload relay must be used

Main dimensions mm, inches

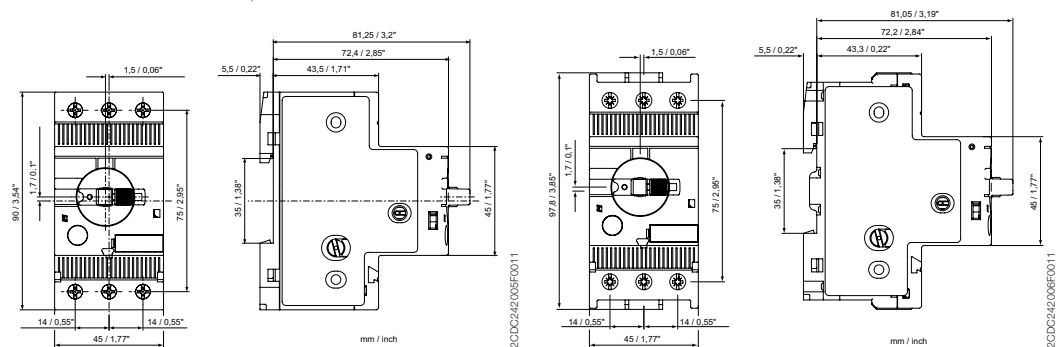

MO132 manual motor starters magnetic only

Technical data

Main circuit – Utilization characteristics according to IEC/EN

Type	MO132
Standards	IEC/EN 60947-2, IEC/EN 60947-4-1, IEC/EN 60947-1
Rated operational voltage U_e	690 V AC
Rated frequency	50/60 Hz
Number of poles	3
Duty time	100 %
Rated impulse withstand voltage U_{imp}	6 kV
Rated insulation voltage U_i	690 V AC
Rated operational current I_e	See ordering details
Rated instantaneous short-circuit current setting I_{sc}	See ordering details
Rated service short-circuit breaking capacity I_{cs}	See table "Short-circuit breaking capacity and back-up fuses"
Rated ultimate short-circuit breaking capacity I_{cu}	See table "Short-circuit breaking capacity and back-up fuses"

Short-circuit breaking capacity and back-up fuses

I_{cs} Rated service short-circuit breaking capacity

I_{cu} Rated ultimate short-circuit breaking capacity

I_{cc} Prospective short-circuit current at installation location

Note: Maximum rated current of the back-up fuses if $I_{cc} > I_{cs}$

Type	230 V AC			400 V AC			440 V AC			500 V AC			690 V AC		
	I_{cs} kA	I_{cu} kA	gG, aM A	I_{cs} kA	I_{cu} kA	gG, aM A	I_{cs} kA	I_{cu} kA	gG, aM A	I_{cs} kA	I_{cu} kA	gG, aM A	I_{cs} kA	I_{cu} kA	gG, aM A
MO132-0.16															
MO132-0.25															
MO132-0.4															
MO132-0.63	No back-up fuse required up to $I_{cc} = 100$ kA														
MO132-1.0															
MO132-1.6															
MO132-2.5															
MO132-4.0	50	50	*	50	50	*	*	*	*	20	20	*	3	3	*
MO132-6.3	50	50	*	50	50	*	*	*	*	20	20	*	3	3	*
MO132-10	50	50	*	50	50	*	*	*	*	20	20	*	3	3	*
MO132-12	50	50	*	50	50	*	*	*	*	20	20	*	3	3	*
MO132-16	50	50	*	50	50	*	*	*	*	20	20	*	3	3	*
MO132-20	50	50	*	50	50	*	*	*	*	20	20	*	3	3	*
MO132-25	50	50	*	50	50	*	*	*	*	10	10	*	3	3	*
MO132-32	25	50	*	25	50	*	*	*	*	10	10	*	3	3	*



*not available yet

General technical data

Type	MO132
Pollution degree	3
Phase loss sensitive	Yes
Ambient air temperature	Operation: -25 ... +60 °C Storage: -50 ... +80 °C
Ambient air temperature compensation	Continuous
Maximum operating altitude permissible	2000 m
Resistance to shock acc. to IEC 60068-2-27	25 g / 11 ms
Resistance to vibrations acc. to IEC 60068-2-6	5 g / 3 ... 150 Hz
Mounting position	Position 1-6 (optional for single mounting)
Mounting	DIN-rail (EN 60715)
Group mounting	On request
Minimum distance to other units same type	Horizontal: 0 mm Vertical: 150 mm
Minimum distance to electrical conductive board	Horizontal, up to 400 V: 0 mm Horizontal, up to 690 V: > 1.5 mm Vertical: 75 mm
Degree of protection	Enclosure / terminals: IP20

Connecting characteristics

Main circuit

Type		MO132-0.16 ... MO132-10	MO132-12 ... MO132-16	MO132-20 ... MO132-32
Connecting capacity	 Solid	1 or 2 x 1 ... 4 mm ²	1 ... 4 mm ²	2.5 ... 6 mm ²
	 Flexible	1 or 2 x 0.75 ... 2.5 mm ²	0.75 ... 2.5 mm ²	1 ... 6 mm ²
	Stranded acc. to UL/CSA	1 or 2 x AWG 16-12	AWG 16-12	AWG 12-8
	Flexible acc. to UL/CSA	1 or 2 x AWG 16-12	AWG 16-12	AWG 12-8
Stripping length		9 mm	10 mm	10 mm
Tightening torques		0.8 ... 1.2 Nm / 10 ... 12 lb.in	1.5 Nm / 14 lb.in	2.0 Nm / 18 lb.in
Connection screw		M3.5 (Pozidriv 2)	M4 (Pozidriv 2)	M4 (Pozidriv 2)

2CDC131036C0201_2s9

MO132 manual motor starters magnetic only

Main accessories

2

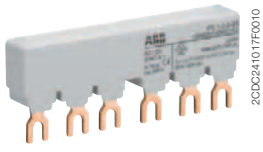

PS1-2-0-65

2CDC241017F000

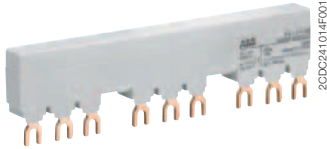

PS1-3-1-100

2CDC241014F000

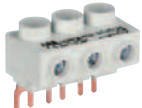

S1-M1-25

1SBC101226F0014



S1-M2-25

1SBC101266F0014



SA1

SKO108B91

Description

Three-phase busbars ensure a quick and safe connection and are therefore a cost effective solution. A variety of different three-phase busbars up to 100 A are in the assortment. Between 2 and 5 manual motor starters with none, one or two lateral auxiliary contacts can be connected. Different three-phase feeder terminals are available according to the application.

Ordering details

Rated operational current A	Number of MMS	Number of lateral aux.	Type	Order code	Pkg qty	Weight (1 pce) kg
Three-phase busbars						
65	2	0	PS1-2-0-65	1SAM201906R1102	10	0.034
65	3	0	PS1-3-0-65	1SAM201906R1103	10	0.055
65	4	0	PS1-4-0-65	1SAM201906R1104	10	0.077
65	5	0	PS1-5-0-65	1SAM201906R1105	10	0.098
65	2	1	PS1-2-1-65	1SAM201906R1112	10	0.036
65	3	1	PS1-3-1-65	1SAM201906R1113	10	0.060
65	4	1	PS1-4-1-65	1SAM201906R1114	10	0.087
65	5	1	PS1-5-1-65	1SAM201906R1115	10	0.108
65	2	2	PS1-2-2-65	1SAM201906R1122	10	0.040
65	3	2	PS1-3-2-65	1SAM201906R1123	10	0.067
65	4	2	PS1-4-2-65	1SAM201906R1124	10	0.095
65	5	2	PS1-5-2-65	1SAM201906R1125	10	0.122
100	3	0	PS1-3-0-100	1SAM201916R1103	10	0.084
100	4	0	PS1-4-0-100	1SAM201916R1104	10	0.117
100	5	0	PS1-5-0-100	1SAM201916R1105	10	0.154
100	3	1	PS1-3-1-100	1SAM201916R1113	10	0.094
100	4	1	PS1-4-1-100	1SAM201916R1114	10	0.134
100	5	1	PS1-5-1-100	1SAM201916R1115	10	0.172
100	3	2	PS1-3-2-100	1SAM201916R1123	10	0.105

Rated operational current A	Rated cross section mm ²	Mounting form	Type	Order code	Pkg qty	Weight (1 pce) kg
Three-phase feeder terminals						
65	25	Flat	S1-M1-25	1SAM201907R1101	10	0.038
65	25	High	S1-M2-25	1SAM201907R1102	10	0.051
65	25	UL type E and IEC	S1-M3-25	1SAM201907R1103	10	0.042
100	35	UL type E and IEC	S1-M3-35	1SAM201913R1103	10	0.060

Description	Type	Order code	Pkg qty	Weight (1 pce) kg
Protection cover for busbars	BS1-3	1SAM201908R1001	50	0.003
Padlock + two keys	SA2	GJF1101903R0002	10	0.020
Screw fixing kit	FS116	1SAM201909R1001	1	0.020

MO132 manual motor starters magnetic only

Main accessories



HKF1-11

1SBC10120BF0014



HK1-11

1SBC10120BF0014



SK1-11

1SBC10121DF0014



AA1-24

1SBC101211F0014



UA1-24

1SBC101212F0014

Description

MO132 manual motor starters can be equipped with auxiliary contacts for lateral/front mounting, signalling contact for lateral mounting, undervoltage release and shunt trips. The accessories can be fitted wiring free and without tools. A variety of combinations is possible as required for the application. The auxiliary contacts change position with the main contacts. Undervoltage release are used for remote tripping of the manual motor starter especially for emergency stop circuits. Shunt trips release the MMS used for remote tripping.

Ordering details

Auxiliary contacts N.O.	Auxiliary contacts N.C.	Description	Type	Order code	Pkg qty	Weight (1 pce)
-------------------------	-------------------------	-------------	------	------------	---------	----------------

Auxiliary contacts – mountable on the front

1	1		HKF1-11	1SAM201901R1001	10	0.015
---	---	--	---------	-----------------	----	-------

Auxiliary contacts – mountable on the right

1	1	Max. 2 pieces	HK1-11	1SAM201902R1001	2	0.035
2	0	Max. 2 pieces	HK1-20	1SAM201902R1002	2	0.035
0	2	Max. 2 pieces	HK1-02	1SAM201902R1003	2	0.035
2	0	With lead contacts	HK1-20L	1SAM201902R1004	2	0.035

Signalling contacts – mountable on the right

1	1	For tripped alarm, max. 2 pieces	SK1-11	1SAM201903R1001	2	0.035
2	0	For tripped alarm, max. 2 pieces	SK1-20	1SAM201903R1002	2	0.035
0	2	For tripped alarm, max. 2 pieces	SK1-02	1SAM201903R1003	2	0.035

Rated control supply voltage	Frequency	Type	Order code	Pkg qty	Weight (1 pce)
V	Hz				kg

Shunt trip units – mountable on the left

24	50/60	AA1-24	1SAM201910R1001	1	0.100
110	50/60	AA1-110	1SAM201910R1002	1	0.100
200 ... 240	50/60	AA1-230	1SAM201910R1003	1	0.100
350 ... 415	50/60	AA1-400	1SAM201910R1004	1	0.100

Undervoltage releases – mountable on the left

24	50	UA1-24	1SAM201904R1001	1	0.100
48	50	UA1-48	1SAM201904R1002	1	0.100
60	50	UA1-60	1SAM201904R1003	1	0.100
110 ... 120	50/60	UA1-120	1SAM201904R1004	1	0.100
208	60	UA1-208	1SAM201904R1005	1	0.100
230 ... 240	50/60	UA1-230	1SAM201904R1006	1	0.100
400	50	UA1-400	1SAM201904R1007	1	0.100
415 ... 480	50/60	UA1-415	1SAM201904R1008	1	0.100

MO132 manual motor starters magnetic only

Main accessories

2



IB132-Y

2CDC241004F0010



IB132-G

2CDC241003F0010



DMS132-Y

2CDC241002F0010



DMS132-G

2CDC241001F0010

Description

IB132 are IP65 enclosures for single MMS installation. Additional mounting of auxiliary and signalling contacts, shunt trips and undervoltage release is possible. The handle is lockable in OFF position. For detailed specification see installation instruction.

DMS132 are IP65 door mounting kits for MMS installation in any enclosure. Additional mounting of auxiliary, signalling, shunt trips and undervoltage release is possible. The handle is lockable in OFF position. For detailed specification see installation instruction.

Ordering details

Description	Color	Type	Order code	Pkg qty	Weight (1 pce) kg
Enclosures IP65					
Padlockable max. 3 padlocks with bail diameter 4 ... 6.5 mm	Yellow/red	IB132-Y	1SAM201911R1011	1	0.370
	Grey/black	IB132-G	1SAM201911R1010	1	0.370
Door mounting kit IP65					
Padlockable max. 3 padlocks with bail diameter 4 ... 6.5 mm	Yellow/red	DMS132-Y	1SAM201912R1011	1	0.170
	Grey/black	DMS132-G	1SAM201912R1010	1	0.170

Indication I-O-T and ON-OFF-T

Main dimensions mm, inches

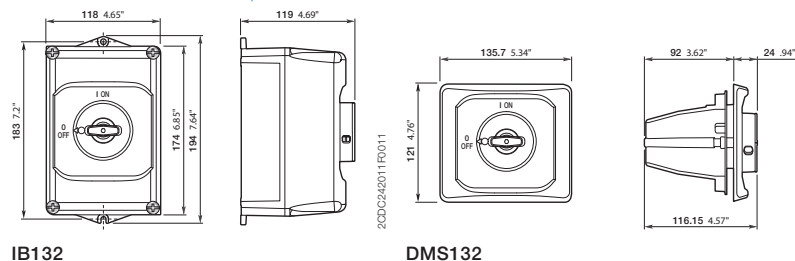

MO132 manual motor starters magnetic only

Main accessories



2CDC241007F0011

MSHD-LTB



2CDC241009F0011

MSHD-LTY



2CDC241004S0011

MSMN

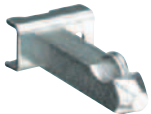

2CDC241005S0011

MSOX-30

Description

The complete set includes handle, shaft and driver. All accessories fit 6 mm shafts of maximum 180 mm length. The degree of protection for handles MSHD is IP64.

Ordering details

Description	Shaft length mm	Type	Order code	Pkg qty	Weight (1 pce) kg
-------------	--------------------	------	------------	------------	-------------------------

Shafts

For selector type handles. Shaft diameter 6 mm. Shaft extension for door coupling driver.

85	OXS6X85	1SCA101647R1001	1	0.020
105	OXS6X105	1SCA108043R1001	1	0.020
130	OXS6X130	1SCA101655R1001	1	0.030
180	OXS6X180	1SCA101659R1001	1	0.040

Description	Color	Type	Order code	Pkg qty	Weight (1 pce) kg
-------------	-------	------	------------	------------	-------------------------

Selector type handles IP64

Padlockable max. 3 padlocks with bail diameter 5 ... 8 mm, door interlock in ON position defeatable, for use with 6 mm OXS6...types up to 180 mm or driver shafts MSOX.

Black	MSHD-LTB ¹⁾	1SAM201920R1011	1	0.065
Yellow	MSHD-LTY ¹⁾	1SAM201920R1012	1	0.065

¹⁾ Indication I-O-T and ON-OFF-T

Description	Type	Order code	Pkg qty	Weight (1 pce) kg
-------------	------	------------	------------	-------------------------

Driver

Coupling driver for use with 6 mm OXS6... types up to 180 mm.

MSMN ¹⁾	1SAM101923R0002	1	0.002
MSMNO ²⁾	1SAM101923R0012	1	0.002

¹⁾ Coded - Positioning of ON indication dependent from mounting orientation of the MS

²⁾ Uncoded - Positioning of ON indication independent from mounting orientation of the MS

Description	Shaft length mm	Type	Order code	Pkg qty	Weight (1 pce) kg
-------------	--------------------	------	------------	------------	-------------------------

Driver shafts

Driver shaft - combination driver & shaft. Shaft diameter 6 mm.

32	MSOX-32 ¹⁾	1SAM101924R0003	1	0.010
30	MSOX-30 ²⁾	1SAM101924R0013	1	0.010

¹⁾ MSOX-32 is for normal vertical use

²⁾ MSOX-30 is for horizontal use

MS450, MS495, MS497 manual motor starters

22 to 100 A – with thermal and electromagnetic protection

2



MS450-40

2CDC241004F0009



MS495-40

1SBC101164F0014



MS497-100

2CDC241023F0011

Description

Manual motor starters (MMS) are protection devices for the main circuit. They combine motor control and protection in a single device. MMS are used mainly to switch motors manually ON/OFF and protect them and the installation fuse less against short-circuit, overload and phase failures. Fuse less protection with a manual motor starter saves costs, space and ensures a quick reaction under short-circuit condition, by switching off the motor within milliseconds.

Further features are the build-in disconnect function, temperature compensation, trip-free mechanism and a rotary handle with a clear switch position indication. The manual motor starter is suitable for three- and single-phase applications. The handle is lockable to protect against unauthorized changes. Auxiliary contacts, signalling contacts, undervoltage releases, shunt trips, three-phase busbars, power in-feed blocks are available as accessory.

Ordering details

Rated operational power 400 V AC-3	Setting range	Short-circuit breaking capacity I_{cs} at 400 V AC	Rated instantaneous short-circuit current setting I_i	Type	Order code	Weight (1 pce)
kW	A	kA	A			kg
MS450 manual motor starter						
15.8	28.0 ... 40.0	25	520.00	MS450-40	1SAM450000R1005	1.047
22	36.0 ... 45.0	25	585.00	MS450-45	1SAM450000R1006	1.039
22	40.0 ... 50.0	25	650.00	MS450-50	1SAM450000R1007	1.027
MS495 manual motor starter						
30	45.0 ... 63.0	25	819.00	MS495-63	1SAM550000R1007	2.247
37	57.0 ... 75.0	25	975.00	MS495-75	1SAM550000R1008	2.253
45	70.0 ... 90.0	25	1170.00	MS495-90	1SAM550000R1009	2.280
55	80.0 ... 100.0	25	1235.00	MS495-100	1SAM550000R1010	2.295
MS497 manual motor starter						
15	22.0 ... 32.0	50	416.00	MS497-32	1SAM580000R1004	2.222
18.5	28.0 ... 40.0	50	520.00	MS497-40	1SAM580000R1005	2.203
22	36.0 ... 50.0	50	650.00	MS497-50	1SAM580000R1006	2.230
30	45.0 ... 63.0	50	819.00	MS497-63	1SAM580000R1007	2.255
37	57.0 ... 75.0	50	975.00	MS497-75	1SAM580000R1008	2.266
45	70.0 ... 90.0	50	1170.00	MS497-90	1SAM580000R1009	2.268
55	80.0 ... 100.0	50	1235.00	MS497-100	1SAM580000R1010	2.275

Main dimensions mm, inches

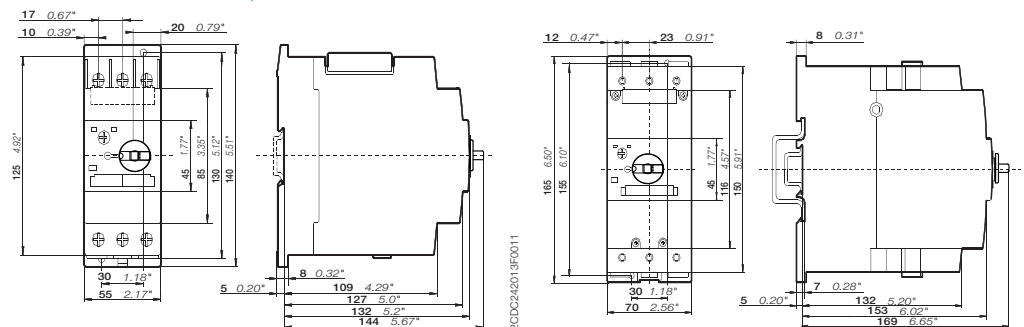

MS450

MS495, MS497

MS450, MS495, MS497 manual motor starters

Technical data

Main circuit – Utilization characteristics according to IEC/EN

Type	MS450, MS495, MS497
Standards	IEC/EN 60947-2, IEC/EN 60947-4-1, IEC/EN 60947-1
Rated operational voltage U_e	690 V AC / 450 V DC
Rated frequency	50/60 Hz
Trip class	10
Number of poles	3
Duty time	100 %
Rated impulse withstand voltage U_{imp}	6 kV
Rated insulation voltage U_i	690 V AC
Rated operational current I_n	See ordering details
Rated instantaneous short-circuit current setting I_{cs}	See ordering details
Rated service short-circuit breaking capacity I_{cs}	See table "Short-circuit breaking capacity and back-up fuses"
Rated ultimate short-circuit breaking capacity I_{cu}	See table "Short-circuit breaking capacity and back-up fuses"

Short-circuit breaking capacity and back-up fuses

I_{cs} Rated service short-circuit breaking capacity

I_{cu} Rated ultimate short-circuit breaking capacity

I_{cc} Prospective short-circuit current at installation location

Note: Maximum rated current of the back-up fuses if $I_{cc} > I_{cs}$

Type	240 V AC			400 V AC			440 V AC			500 V AC			690 V AC		
	I_{cs} kA	I_{cu} kA	gG, aM A	I_{cs} kA	I_{cu} kA	gG, aM A	I_{cs} kA	I_{cu} kA	gG, aM A	I_{cs} kA	I_{cu} kA	gG, aM A	I_{cs} kA	I_{cu} kA	gG, aM A
Short-circuit protection MS450															
MS450-40	No back-up fuse required up to $I_{cc} = 100$ kA			25	50	160	15	50	125	5	10	100	2	4	63
MS450-45				25	50	160	15	50	125	5	10	100	2	4	63
MS450-50				25	50	160	15	50	125	5	10	100	2	4	80

MS450: No need for back-up fuse in networks with a prospective current of up to 50 kA at 400 V.
With an appropriate 160 A type gG fuse the device can be used in a network with a prospective current of up to 100 kA.

Short-circuit protection MS495

MS495-40	No back-up fuse required up to $I_{cc} = 100$ kA			25	50	125	20	50	125	6	12	125	3	6	63
MS495-50				25	50	125	20	50	125	6	12	125	3	6	80
MS495-63				25	50	160	20	50	160	6	12	160	3	6	80
MS495-75				25	50	160	20	50	160	6	8	160	3	5	100
MS495-90				25	50	160	20	50	160	6	8	160	3	5	125
MS495-100				25	50	160	20	50	160	6	8	160	3	5	125

MS495-40: No need for back-up fuse in networks with a prospective current of up to 50 kA at 400 V.
With an appropriate 125 A type gG fuse the device can be used in a network with a prospective current of up to 100 kA.
MS495-100: No need for back-up fuse in networks with a prospective current of up to 50 kA at 400 V.
With an appropriate 160 A type gG fuse the device can be used in a network with a prospective current of up to 100 kA.

Short-circuit protection MS497

MS497-32	No back-up fuse required up to $I_{cc} = 100$ kA			50	100	No back-up fuse required up to $I_{cc} = 100$ kA	50	100	No back-up fuse required up to $I_{cc} = 100$ kA	11	22	100	7	12	63
MS497-40				50	100		50	100	9	18	160	6	12	80	
MS497-50				50	100		50	100	7.5	15	160	5	10	100	
MS497-63				50	100		50	70	200	7.5	15	160	4	7.5	100
MS497-75				50	100		50	70	200	5	10	160	3	6	125
MS497-90				50	100		50	70	200	5	10	160	3	6	160
MS497-100				50	100		50	70	200	5	10	160	3	6	160

MS497-32: No need for back-up fuse in networks with a prospective current of up to 100 kA at 440 V.
MS497-90: No need for back-up fuse in networks with a prospective current of up to 70 kA at 440 V.
With an appropriate 200 A type gG fuse the device can be used in a network with a prospective current of up to 100 kA.



MS450, MS495, MS497 manual motor starters

Technical data

General technical data

Type		MS450	MS495	MS497
Pollution degree		3		
Phase loss sensitive		Yes		
Ambient air temperature				
Operation	Open - compensated without derating	-20 ... +60 °C		
	Open	-20 ... +70 °C		
	Enclosed	-20 ... +35 °C		
Storage		-50 ... +80 °C		
Ambient air temperature compensation		Continuous		
Maximum operating altitude permissible		2000 m		
Resistance to shock acc. to IEC 60068-2-27		25 g / 11 ms	-	
Resistance to vibrations acc. to IEC 60068-2-6		2 g / 5-150 Hz		
Mounting position		Position 1-6 (optional for single mounting)		
Mounting		DIN-rail 35 mm (EN 60715)	DIN-rail 15 mm / 75 mm (EN 60715)	
Minimum distance to other units same type	Horizontal	0 mm	0 mm	
	Vertical - up to 240 V	-	50 mm	
	Vertical - up to 440 V	-	70 mm	
	Vertical - up to 500 V	-	110 mm	
	Vertical - up to 690 V	-	150 mm	
	Vertical	50 mm	-	
Minimum distance to electrical conductive board	Horizontal	10 mm	-	
	Horizontal - up to 500 V	-	10 mm	
	Horizontal - up to 690 V	-	30 mm	
	Vertical - up to 240 V	-	50 mm	
	Vertical - up to 440 V	-	70 mm	
	Vertical - up to 500 V	-	110 mm	
	Vertical - up to 690 V	-	150 mm	
	Vertical	50 mm	-	
Degree of protection	Enclosure / terminals	IP20		

Connecting characteristics

Main circuit				
Type		MS450	MS495	MS497
Connecting capacity				
 Solid	1 or 2 x	0.75 ... 16 mm ²	2.5 ... 16 mm ²	2.5 ... 16 mm ²
	1 x	0.75 ... 35 mm ²	10 ... 70 mm ²	10 ... 70 mm ²
 Flexible	2 x	0.75 ... 25 mm ²	10 ... 50 mm ²	10 ... 50 mm ²
	1 x	AWG 18-2	AWG 10-2/0	AWG 10-2/0
Stranded acc. to UL/CSA	2 x	AWG 18-2	AWG 10-1/0	AWG 10-1/0
	1 x	AWG 18-2	AWG 10-2/0	AWG 10-2/0
Flexible acc. to UL/CSA	2 x	AWG 18-2	AWG 10-1/0	AWG 10-1/0
	1 x	AWG 18-2	AWG 10-2/0	AWG 10-2/0
Stripping length		13 mm	17 mm	17 mm
Tightening torques		3 - 4.5 Nm / 27 ... 40 lb.in	4 - 6 Nm / 35 - 53 lb.in	4 - 6 Nm / 35 - 53 lb.in
Connection screw		Pozidriv 2	Hexagon 4	Hexagon 4

MS450, MS495, MS497 manual motor starters

Main accessories



SA2

SKO 109891

Description

Three-phase busbars ensure a quick and safe connection and are therefore a cost-effective solution. A variety of different three-phase busbars up to 108A are in the assortment. Between 2 and 4 manual motor starters with none or two lateral auxiliary contacts can be connected.

Ordering details

Rated operational current A	Number of MMS	Number of lateral aux.	Type	Order code	Pkg qty	Weight (1 pce) kg
--------------------------------	---------------	------------------------	------	------------	---------	----------------------

Three-phase busbars for MS450 only

108	2	0	PS4-2-0	1SAM401911R1001	5	0.134
108	3	0	PS4-3-0	1SAM401911R1002	5	0.206
108	4	0	PS4-4-0	1SAM401911R1003	5	0.280
108	2	1	PS4-2-2	1SAM401911R1004	5	0.148
108	3	1	PS4-3-2	1SAM401911R1005	5	0.250
108	4	1	PS4-4-2	1SAM401911R1006	5	0.362

Rated operational current A	Rated cross section mm ²	Mounting form	Type	Order code	Pkg qty	Weight (1 pce) kg
--------------------------------	--	---------------	------	------------	---------	----------------------

Three-phase feeder terminals for MS450 only

108	25	Flat	S4-M1	1SAM401911R1007	2	0.106
-----	----	------	-------	-----------------	---	-------

Description	For MMS	Type	Order code	Pkg qty	Weight (1 pce) kg
Protection cover for busbar	PS4	BS4-3	1SAM401911R1008	10	0.001
Disconnecter module	MS450	TB450	1SAM401910R1001	1	0.315
Terminal shroud	MS450	KA450	1SAM401908R1001	1	0.154
Terminal shroud	MS495	KA495	1SAM501901R1001	10	0.018
Terminal shroud	MS495	KA495C ¹⁾	1SAM501902R1001	10	0.038
Terminal insulation barrier for UL508E	MS495	DX495	1SAM401912R1001	1	0.154
Padlock + 2 keys	MS450, MS495, MS497	SA2	GJF1101903R0002	10	0.020

¹⁾ Is plugged onto the housing after removing the box terminals, if using cable lugs.

MS450, MS495, MS497 manual motor starters

Main accessories

2



HK4-11

2CDC241026S0011



HKS4-20

2CDC241026S0011



SK4-11

2CDC241026S0011



AA4-24

2CDC241026S0011

Description

MS450, MS495, MS497 manual motor starters can be equipped with auxiliary contacts for lateral/front mounting, signalling contact for lateral mounting, undervoltage release and shunt trips. The accessories can be fitted wiring free and without tools. A variety of combinations is possible as required for the application. The auxiliary contacts change position with the main contacts. Undervoltage release are used for remote tripping of the manual motor starter especially for emergency stop circuits. Shunt trips release the MMS used for remote tripping.

Ordering details

Auxiliary contacts N.O.	Auxiliary contacts N.C.	Description	Type	Order code	Pkg qty	Weight (1 pce) kg
-------------------------	-------------------------	-------------	------	------------	---------	-------------------

Auxiliary contacts – mountable on the front

1	1		HK4-11	1SAM401901R1001	10	0.017
		Changeover	HK4-W	1SAM401901R1002	10	0.015

Auxiliary contacts – mountable on the left

1	1	Max. 1 pieces	HKS4-11	1SAM401902R1001	2	0.045
2	0	Max. 1 pieces	HKS4-20	1SAM401902R1002	2	0.045
0	2	Max. 1 pieces	HKS4-02	1SAM401902R1003	2	0.045

Signalling contacts – mountable on the right

2	2	Separate signalling acc. UL508E 1 N.O. + 1 N.C. for short circuit and 1NO+NC for general tripping , max. 2 pieces	SK4-11	1SAM401904R1001	1	0.093
---	---	--	--------	-----------------	---	-------

Rated control supply voltage V	Frequency Hz	Type	Order code	Pkg qty	Weight (1 pce) kg
--------------------------------	--------------	------	------------	---------	-------------------

Shunt trip units – mountable on the left

20 ... 24	50/60	AA4-24	1SAM401907R1001	1	0.135
90 ... 110	50/60	AA4-110	1SAM401907R1002	1	0.135
200 ... 240	50/60	AA4-230	1SAM401907R1003	1	0.128
350 ... 415	50/60	AA4-400	1SAM401907R1004	1	0.125

Undervoltage releases – mountable on the left

24	50/60	UA4-24	1SAM401905R1004	1	0.134
110/120	50/60	UA4-110	1SAM401905R1001	1	0.134
230/240	50/60	UA4-230	1SAM401905R1002	1	0.131
400/440	50/60	UA4-400	1SAM401905R1003	1	0.129
230/240	50/60	UA4-HK-230	1SAM401906R1001	1	0.140
400/440	50/60	UA4-HK-400	1SAM401906R1002	1	0.137

MS450, MS495, MS497 manual motor starters



Main accessories

General technical data

Type		PS4-xxx	S4-M1
Standards		IEC/EN 60947-1	
Rated operational voltage U_e		690 V AC	
Rated operational current I_e		108 A	
Rated frequency		50/60 Hz	
Rated impulse withstand voltage U_{imp}		6 kV	
Rated insulation voltage U_i		690 V AC	
Pollution degree		3	
Cross-section		10 mm ²	25 mm ²
Ambient air temperature	Operation	-25 ... +70 °C	
	Storage	-50 ... +80 °C	

Electrical connection

Main circuit

Type		S4-M1
Connecting capacity		
 Solid	1 x	2.5 ... 50 mm ²
 Flexible	1 x	4 ... 16 mm ²
Stranded acc. to UL/CSA	1 x	AWG 14-4
Flexible acc. to UL/CSA	1 x	AWG 14-4
Tightening torques		4 Nm
Connection screw		Pozidriv 2

MS450, MS495, MS497 manual motor starters



Main accessories

General technical data

Type	HK4-11	HK4-W	HKS4	SK4	
Standards	IEC/EN 60947-1, IEC/EN 60947-5-1, UL 508, CSA22.2 No. 14				
Rated operational voltage U_e	230 V AC / 220 V DC	690 V AC / 220 V DC	690 V AC	690 V AC	
Conventional free-air thermal current I_{th}	2.5 A	5 A	10 A	10 A	
Rated frequency	DC, 50/60 Hz				
Rated impulse withstand voltage U_{imp}	6 kV				
Rated insulation voltage U_i	300 V	300 V	690 V	690 V	
Pollution degree	3				
Ambient air temperature	Operation -20 ... +70 °C Storage -50 ... +80 °C				
Resistance to shock acc. to IEC 60068-2-27	25 g / 11 ms				
Resistance to vibrations acc. to IEC 60068-2-6	2 g / 5 ... 150Hz				
Number of poles	1 N.C. + 1 N.O.	Changeover	1 N.C. + 1 N.O. / 2 N.O. / 2 N.C.	2 N.C. + 2 N.O.	
I_e / Rated operational current AC-15 acc. to IEC/EN 60947-5-1 for utilization category					
	24 V, 50/60 Hz	2 A	4 A	6 A	6 A
	230 V, 50/60 Hz	0.5 A	3 A	4 A	4 A
	400 V, 50/60 Hz	-	1.5 A	3 A	3 A
	690 V, 50/60 Hz	-	0.5 A	1 A	1 A
I_e / Rated operational current DC-13 acc. to IEC/EN 60947-5-1 for utilization category					
	24 V	1 A	1 A	2 A	2 A
	48 V	0.3 A	-	-	-
	60 V	0.15 A	-	-	-
	110 V	-	0.22 A	0.5 A	0.5 A
	230 V	-	0.1 A	0.25 A	0.25 A
Minimum switching capacity	17 V / 1 mA				
Short-circuit protective device	10 A Type gG				
Duty time	100 %				
Mounting	Front of MMS	Front of MMS	Left side of MMS	Left side of MMS	
Mounting positions	1-6				
Mechanical durability	100000 cycles				
Electrical durability	100000 cycles				

Electrical connection

Main circuit

Type	HK4-11	HK4-W	HKS4	SK4
Connecting capacity				
 Solid	1 x	0.5 ... 2.5 mm ²		
	2 x	0.5 ... 1.5 mm ² or 0.75 ... 2.5 mm		
 Flexible	1 x	0.5 ... 2.5 mm ²		
	2 x	0.5 ... 1.5 mm ² or 0.75 ... 2.5 mm		
Stranded acc. to UL/CSA	1 or 2 x	AWG 18-14		
Flexible acc. to UL/CSA	1 or 2 x	AWG 18-14		
Stripping length	10 mm			
Tightening torques	0.8 ... 1.2 Nm / 7 ... 10.3 lb.in			
Connection screw	Pozidriv 2			

MS450, MS495, MS497 manual motor starters

Main accessories



MSHD-LTB

2CDC241007F0011



MSHD-LTY

2CDC241006F0011



MSMN

2CDC241004F0011

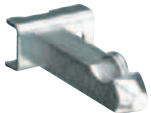

MSOX-30

2CDC241006F0011

Description

The complete set includes handle, shaft and driver. All accessories fit 6 mm shafts of maximum 180 mm length. The degree of protection for handles MSHD is IP64.

Ordering details

Description	Shaft length mm	Type	Order code	Pkg qty	Weight (1 pce) kg
-------------	--------------------	------	------------	------------	-------------------------

Shafts

For selector type handles. Shaft diameter 6 mm. Shaft extension for door coupling driver.

85	OXS6X85	1SCA101647R1001	1	0.020
105	OXS6X105	1SCA108043R1001	1	0.020
130	OXS6X130	1SCA101655R1001	1	0.030
180	OXS6X180	1SCA101659R1001	1	0.040

Description	Color	Type	Order code	Pkg qty	Weight (1 pce) kg
-------------	-------	------	------------	------------	-------------------------

Selector type handles IP64

Padlockable max. 3 padlocks with bail diameter 5 ... 8 mm, door interlock in ON position defeatable, for use with 6 mm OXS6...types up to 180 mm or driver shafts MSOX.

Black	MSHD-LTB ¹⁾	1SAM201920R1011	1	0.065
Yellow	MSHD-LTY ¹⁾	1SAM201920R1012	1	0.065

¹⁾ Indication I-O-T and ON-OFF-T

Description	Type	Order code	Pkg qty	Weight (1 pce) kg
-------------	------	------------	------------	-------------------------

Driver

Coupling driver for use with 6 mm OXS6... types up to 180 mm.

MSMN ¹⁾	1SAM101923R0002	1	0.002
MSMNO ²⁾	1SAM101923R0012	1	0.002

¹⁾ Coded - Positioning of ON indication dependent from mounting orientation of the MS

²⁾ Uncoded - Positioning of ON indication independent from mounting orientation of the MS

Description	Shaft length mm	Type	Order code	Pkg qty	Weight (1 pce) kg
-------------	--------------------	------	------------	------------	-------------------------

Driver shafts

Driver shaft - combination driver & shaft. Shaft diameter 6 mm.

32	MSOX-32 ¹⁾	1SAM101924R0003	1	0.010
30	MSOX-30 ²⁾	1SAM101924R0013	1	0.010

¹⁾ MSOX-32 is for normal vertical use

²⁾ MSOX-30 is for horizontal use

MO450, MO495, MO496 manual motor starters magnetic only 16 to 100 A – with electromagnetic protection

2



MO450-40

STO29501



MO495-75

STO29601



MO496-100

2CDC241021S0011

Description

The manual motor starter magnetic only is used to manually switch on and off motors and to protect them reliably and without the need for a fuse from short-circuits.

Further features are the built-in disconnect function, trip-free mechanism and a rotary handle with a clear switch position indication. The manual motor starter magnetic only is suitable for three- and single-phase applications. The handle is lockable to protect against unauthorized changes. Auxiliary contacts, signalling contacts, undervoltage releases, shunt trips, three-phase busbars, power in-feed blocks are available as accessory.

Ordering details

Rated operational power 400 V AC-3 ¹⁾ kW	Rated operational current A	Short-circuit breaking capacity I _{cs} at 400 V AC kA	Rated instantaneous short-circuit current setting I _i A	Type	Order code	Weight (1 pce) kg
MO450 manual motor starter						
15.8	40	25	520.00	MO450-40	1SAM460000R1005	1.033
22	45	25	585.00	MO450-45	1SAM460000R1006	1.040
22	50	25	650.00	MO450-50	1SAM460000R1007	1.019
MO495 manual motor starter						
30	63	25	819.00	MO495-63	1SAM560000R1007	2.244
37	75	25	975.00	MO495-75	1SAM560000R1008	2.247
45	90	25	1170.00	MO495-90	1SAM560000R1009	2.269
55	100	25	1235.00	MO495-100	1SAM560000R1010	2.292
MO496 manual motor starter						
7.5	16	50	208.00	MO496-16	1SAM590000R1001	2.175
9.0	20	50	260.00	MO496-20	1SAM590000R1002	2.188
12.5	25	50	325.00	MO496-25	1SAM590000R1003	2.219
15	32	50	416.00	MO496-32	1SAM590000R1004	2.208
18.5	40	50	520.00	MO496-40	1SAM590000R1005	2.218
22	50	50	650.00	MO496-50	1SAM590000R1006	2.218
30	63	50	819.00	MO496-63	1SAM590000R1007	2.248
37	75	50	975.00	MO496-75	1SAM590000R1008	2.278
45	90	50	1170.00	MO496-90	1SAM590000R1009	2.266
55	100	50	1235.00	MO496-100	1SAM590000R1010	2.293

¹⁾ For overload protection of motors, an appropriate thermal or electronic overload relay must be used

Main dimensions mm, inches

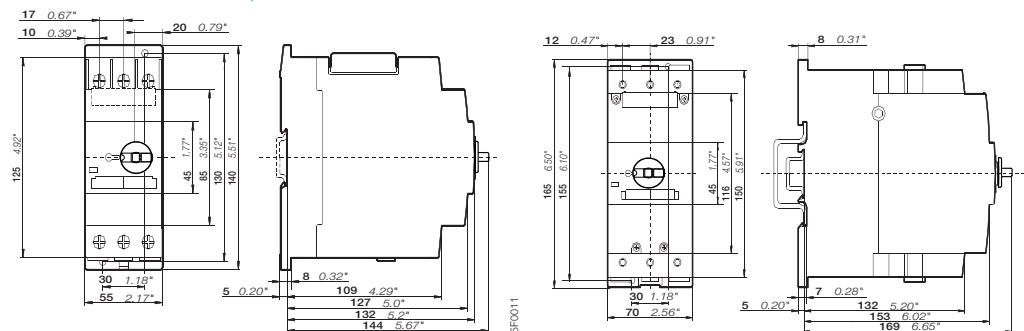

MO450

MO495, MO496

MO450, MO495, MO496 manual motor starters magnetic only

Technical data

Main circuit – Utilization characteristics according to IEC/EN

Type	MO450, MO495, MO496
Standards	IEC/EN 60947-2, IEC/EN 60947-4-1, IEC/EN 60947-1
Rated operational voltage U_e	690 V AC / 450 V DC
Rated frequency	50/60 Hz
Number of poles	3
Duty time	100 %
Rated impulse withstand voltage U_{imp}	6 kV
Rated insulation voltage U_i	690 V AC
Rated operational current I_e	See ordering details
Rated instantaneous short-circuit current setting I_i	See ordering details
Rated service short-circuit breaking capacity I_{cs}	See table "Short-circuit breaking capacity and back-up fuses"
Rated ultimate short-circuit breaking capacity I_{cu}	See table "Short-circuit breaking capacity and back-up fuses"

Short-circuit breaking capacity and back-up fuses

I_{cs} Rated service short-circuit breaking capacity

I_{cu} Rated ultimate short-circuit breaking capacity

I_{cc} Prospective short-circuit current at installation location

Note: Maximum rated current of the back-up fuses if $I_{cc} > I_{cs}$

Type	240 V AC			400 V AC			440 V AC			500 V AC			690 V AC		
	I_{cs} kA	I_{cu} kA	gG, aM A	I_{cs} kA	I_{cu} kA	gG, aM A	I_{cs} kA	I_{cu} kA	gG, aM A	I_{cs} kA	I_{cu} kA	gG, aM A	I_{cs} kA	I_{cu} kA	gG, aM A
Short-circuit protection MO450															
MO450-40	No back-up fuse required up to $I_{cc} = 100$ kA			25	50	160	15	50	125	5	10	100	2	4	63
MO450-45				25	50	160	15	50	125	5	10	100	2	4	63
MO450-50				25	50	160	15	50	125	5	10	100	2	4	80

MO450: No need for back-up fuse in networks with a prospective current of up to 50 kA at 400 V.
With an appropriate 160 A type gG fuse the device can be used in a network with a prospective current of up to 100 kA.

Short-circuit protection MO495

MO495-63	25	50	160	20	50	160	6	12	160	3	6	80
MO495-75	25	50	160	20	50	160	6	8	160	3	5	100
MO495-90	25	50	160	20	50	160	6	8	160	3	5	125
MO495-100	25	50	160	20	50	160	6	8	160	3	5	125

MO495-100: No need for back-up fuse in networks with a prospective current of up to 50 kA at 400 V.
With an appropriate 160 A type gG fuse the device can be used in a network with a prospective current of up to 100 kA.

Short-circuit protection MO496

MO496-16	No back-up fuse required up to $I_{cc} = 100$ kA			50	100	No back-up fuse required up to $I_{cc} = 100$ kA	50	100	No back-up fuse required up to $I_{cc} = 100$ kA	11	22	100	7	12	63
MO496-20				50	100		50	100		11	22	100	7	12	63
MO496-25				50	100		50	100		11	22	100	7	12	63
MO496-32				50	100		50	100	11	22	100	7	12	63	
MO496-40				50	100		50	100	9	18	160	6	12	80	
MO496-50				50	100		50	100	7.5	15	160	5	10	100	
MO496-63				50	100		50	70	200	7.5	15	160	4	7.5	100
MO496-75				50	100		50	70	200	5	10	160	3	6	125
MO496-90				50	100		50	70	200	5	10	160	3	6	160
MO496-100				50	100		50	70	200	5	10	160	3	6	160

MO496-32: No need for back-up fuse in networks with a prospective current of up to 100 kA at 440 V.
MO496-90: No need for back-up fuse in networks with a prospective current of up to 70 kA at 440 V.
With an appropriate 200 A type gG fuse the device can be used in a network with a prospective current of up to 100 kA.



MO450, MO495, MO496 manual motor starters magnetic only

Technical data

General technical data

Type		MO450	MO495	MO496
Pollution degree		3		
Phase loss sensitive		Yes		
Ambient air temperature				
Operation	Open - compensated without derating	-20 ... +60 °C		
	Open	-20 ... +70 °C		
	Enclosed	-20 ... +35 °C		
Storage		-50 ... +80 °C		
Ambient air temperature compensation		Continuous		
Maximum operating altitude permissible		2000 m		
Resistance to shock acc. to IEC 60068-2-27		25 g / 11 ms		
Resistance to vibrations acc. to IEC 60068-2-6		2 g / 5-150 Hz	-	
Mounting position		Position 1-6 (optional for single mounting)		
Mounting		DIN-rail 35 mm (EN 60715)	DIN-rail 15 mm / 75 mm (EN 60715)	
Minimum distance to other units same type	Horizontal	0 mm	0 mm	
	Vertical - up to 240 V	-	50 mm	
	Vertical - up to 440 V	-	70 mm	
	Vertical - up to 500 V	-	110 mm	
	Vertical - up to 690 V	-	150 mm	
	Vertical	50 mm	-	
Minimum distance to electrical conductive board	Horizontal	10 mm	-	
	Horizontal - up to 500 V	-	10 mm	
	Horizontal - up to 690 V	-	30 mm	
	Vertical - up to 240 V	-	50 mm	
	Vertical - up to 440 V	-	70 mm	
	Vertical - up to 500 V	-	110 mm	
	Vertical - up to 690 V	-	150 mm	
	Vertical	50 mm	-	
Degree of protection	Enclosure / terminals	IP20		

Connecting characteristics

Type		MO450	MO495	MO496
Connecting capacity				
 Solid	1 or 2 x	0.75 ... 16 mm ²	2.5 ... 16 mm ²	2.5 ... 16 mm ²
 Flexible	1 x	0.75 ... 35 mm ²	10 ... 70 mm ²	10 ... 70 mm ²
	2 x	0.75 ... 25 mm ²	10 ... 50 mm ²	10 ... 50 mm ²
Stranded acc. to UL/CSA	1 x	AWG 18-2	AWG 10-2/0	AWG 10-2/0
	2 x	AWG 18-2	AWG 10-1/0	AWG 10-1/0
Flexible acc. to UL/CSA	1 x	AWG 18-2	AWG 10-2/0	AWG 10-2/0
	2 x	AWG 18-2	AWG 10-1/0	AWG 10-1/0
Stripping length		13 mm	17 mm	17 mm
Tightening torques		3 - 4.5 Nm / 27 ... 40 lb.in	4 - 6 Nm / 35 - 53 lb.in	4 - 6 Nm / 35 - 53 lb.in
Connection screw		Pozidriv 2	Hexagon 4	Hexagon 4

MO450, MO495, MO496 manual motor starters magnetic only

Main accessories



SA2

SKO 109891

Description

Three-phase busbars ensure a quick and safe connection and are therefore a cost-effective solution. A variety of different three-phase busbars up to 108 A are in the assortment. Between 2 and 4 manual motor starters with none or two lateral auxiliary contacts can be connected.

Ordering details

Rated operational current A	Number of MMS	Number of lateral aux.	Type	Order code	Pkg qty	Weight (1 pce) kg
--------------------------------	---------------	------------------------	------	------------	---------	----------------------

Three-phase busbars for MO450 only

108	2	0	PS4-2-0	1SAM401911R1001	5	0.134
108	3	0	PS4-3-0	1SAM401911R1002	5	0.206
108	4	0	PS4-4-0	1SAM401911R1003	5	0.280
108	2	1	PS4-2-2	1SAM401911R1004	5	0.148
108	3	1	PS4-3-2	1SAM401911R1005	5	0.250
108	4	1	PS4-4-2	1SAM401911R1006	5	0.362

Rated operational current A	Rated cross section mm ²	Mounting form	Type	Order code	Pkg qty	Weight (1 pce) kg
--------------------------------	--	---------------	------	------------	---------	----------------------

Three-phase feeder terminals for MO450 only

108	25	Flat	S4-M1	1SAM401911R1007	2	0.106
-----	----	------	-------	-----------------	---	-------

Description	for MMS	Type	Order code	Pkg qty	Weight (1 pce) kg
Protection cover for busbar	PS4	BS4-3	1SAM401911R1008	10	0.001
Disconnecter module	MO450	TB450	1SAM401910R1001	1	0.315
Terminal shroud	MO450	KA450	1SAM401908R1001	1	0.154
Terminal shroud	MO495	KA495	1SAM501901R1001	10	0.018
Terminal shroud	MO495	KA495C ⁽¹⁾	1SAM501902R1001	10	0.038
Terminal insulation barrier for UL508E	MO495	DX495	1SAM401912R1001	1	0.154
Padlock + 2 keys	MO450, MO495, MO496	SA2	GJF1101903R0002		

⁽¹⁾ is plugged onto the housing after removing the box terminals, if using cable lugs or buses

MO450, MO495, MO496 manual motor starters magnetic only

Main accessories

2



HK4-11

2CDC241026S0011



HKS4-20

2CDC241026S0011



SK4-11

2CDC241026S0011



AA4-24

2CDC241026S0011

Description

MO450, MO495, MO497 manual motor starters can be equipped with auxiliary contacts for lateral/front mounting, signalling contact for lateral mounting, undervoltage release and shunt trips. The accessories can be fitted wiring free and without tools. A variety of combinations is possible as required for the application. The auxiliary contacts change position with the main contacts. Undervoltage release are used for remote tripping of the manual motor starter especially for emergency stop circuits. Shunt trips release the MMS used for remote tripping.

Ordering details

Auxiliary contacts N.O.	Auxiliary contacts N.C.	Description	Type	Order code	Pkg qty	Weight (1 pce)
Auxiliary contacts – mountable on the front						
1	1		HK4-11	1SAM401901R1001	10	0.017
-	-	Changeover	HK4-W	1SAM401901R1002	10	0.015
Auxiliary contacts – mountable on the left						
1	1	Max. 1 pieces	HKS4-11	1SAM401902R1001	2	0.045
2	0	Max. 1 pieces	HKS4-20	1SAM401902R1002	2	0.045
0	2	Max. 1 pieces	HKS4-02	1SAM401902R1003	2	0.045
Signalling contacts – mountable on the right						
2	2	Separate signalling acc. UL508E 1 N.O. + 1 N.C. for short circuit and 1 N.O. + 1 N.C. for general tripping, max. 2 pieces	SK4-11	1SAM401904R1001	1	0.093

Rated control supply voltage	Frequency	Type	Order code	Pkg qty	Weight (1 pce)
V	Hz				kg
Shunt trip units – mountable on the left					
20 ... 24	50/60	AA4-24	1SAM401907R1001	1	0.135
90 ... 110	50/60	AA4-110	1SAM401907R1002	1	0.135
200 ... 240	50/60	AA4-230	1SAM401907R1003	1	0.128
350 ... 415	50/60	AA4-400	1SAM401907R1004	1	0.125
Undervoltage releases – mountable on the left					
24	50/60	UA4-24	1SAM401905R1004	1	0.134
110/120	50/60	UA4-110	1SAM401905R1001	1	0.134
230/240	50/60	UA4-230	1SAM401905R1002	1	0.131
400/440	50/60	UA4-400	1SAM401905R1003	1	0.129
230/240	50/60	UA4-HK-230	1SAM401906R1001	1	0.140
400/440	50/60	UA4-HK-400	1SAM401906R1002	1	0.137

MO450, MO495, MO496 manual motor starters magnetic only



Main accessories

General technical data

Type		PS4-xxx	S4-M1
Standards		IEC/EN 60947-1	
Rated operational voltage U_e		690 V AC	
Rated operational current I_e		108 A	
Rated frequency		50/60 Hz	
Rated impulse withstand voltage U_{imp}		6 kV	
Rated insulation voltage U_i		690 V AC	
Pollution degree		3	
Cross-section		10 mm ²	25 mm ²
Ambient air temperature	Operation	-25 ... +70 °C	
	Storage	-50 ... +80 °C	

Electrical connection

Main circuit

Type		S4-M1
Connecting capacity		
 Solid	1 x	2.5 ... 50 mm ²
 Flexible	1 x	4 ... 16 mm ²
Stranded acc. to UL/CSA	1 x	AWG 14-4
Flexible acc. to UL/CSA	1 x	AWG 14-4
Tightening torques		4 Nm
Connection screw		Pozidriv 2

MO450, MO495, MO496 manual motor starters magnetic only



Main accessories

General technical data

Type	HK4-11	HK4-W	HKS4	SK4	
Standards	IEC/EN 60947-1, IEC/EN 60947-5-1, UL 508, CSA22.2 No. 14				
Rated operational voltage U_e	230 V AC / 220 V DC	690 V AC / 220 V DC	690 V AC	690 V AC	
Conventional free-air thermal current I_{th}	2.5 A	5 A	10 A	10 A	
Rated frequency	DC, 50/60 Hz				
Rated impulse withstand voltage U_{imp}	6 kV				
Rated insulation voltage U_i	300 V	300 V	690 V	690 V	
Pollution degree	3				
Ambient air temperature	Operation -20 ... +70 °C Storage -50 ... +80 °C				
Resistance to shock acc. to IEC 60068-2-27	25 g / 11 ms				
Resistance to vibrations acc. to IEC 60068-2-6	2 g / 5 ... 150Hz				
Number of poles	1 N.C. + 1 N.O.	Changeover	1 N.C. + 1 N.O. / 2 N.O. / 2 N.C.	2 N.C. + 2 N.O.	
I_e / Rated operational current AC-15 acc. to IEC/EN 60947-5-1 for utilization category					
	24 V, 50/60 Hz	2 A	4 A	6 A	6 A
	230 V, 50/60 Hz	0.5 A	3 A	4 A	4 A
	400 V, 50/60 Hz	-	1.5 A	3 A	3 A
	690 V, 50/60 Hz	-	0.5 A	1 A	1 A
I_e / Rated operational current DC-13 acc. to IEC/EN 60947-5-1 for utilization category					
	24 V	1 A	1 A	2 A	2 A
	48 V	0.3 A	-	-	-
	60 V	0.15 A	-	-	-
	110 V	-	0.22 A	0.5 A	0.5 A
	230 V	-	0.1 A	0.25 A	0.25 A
Minimum switching capacity	17 V / 1 mA				
Short-circuit protective device	10 A Type gG				
Duty time	100 %				
Mounting	Front of MMS	Front of MMS	Left side of MMS	Left side of MMS	
Mounting positions	1-6				
Mechanical durability	100000 cycles				
Electrical durability	100000 cycles				

Electrical connection

Main circuit

Type	HK4-11	HK4-W	HKS4	SK4
Connecting capacity				
 Solid	1 x	0.5 ... 2.5 mm ²		
	2 x	0.5 ... 1.5 mm ² or 0.75 ... 2.5 mm		
 Flexible	1 x	0.5 ... 2.5 mm ²		
	2 x	0.5 ... 1.5 mm ² or 0.75 ... 2.5 mm		
Stranded acc. to UL/CSA	1 or 2 x	AWG 18-14		
Flexible acc. to UL/CSA	1 or 2 x	AWG 18-14		
Stripping length	10 mm			
Tightening torques	0.8 ... 1.2 Nm / 7 ... 10.3 lb.in			
Connection screw	Pozidriv 2			

MO450, MO495, MO496 manual motor starters magnetic only

Main accessories



2CDC241007F0011

MSHD-LTB



2CDC241008F0011

MSHD-LTY



2CDC241004F0011

MSMN



2CDC241006F0011

MSOX-30

Description

The complete set includes handle, shaft and driver. All accessories fit 6 mm shafts of maximum 180 mm length. The degree of protection for handles MSHD is IP64.

Ordering details

Description	Shaft length mm	Type	Order code	Pkg qty	Weight (1 pce) kg
-------------	--------------------	------	------------	------------	-------------------------

Shafts

For selector type handles. Shaft diameter 6 mm. Shaft extension for door coupling driver.

85	OXS6X85	1SCA101647R1001	1	0.020
105	OXS6X105	1SCA108043R1001	1	0.020
130	OXS6X130	1SCA101655R1001	1	0.030
180	OXS6X180	1SCA101659R1001	1	0.040

Description	Color	Type	Order code	Pkg qty	Weight (1 pce) kg
-------------	-------	------	------------	------------	-------------------------

Selector type handles IP64

Padlockable max. 3 padlocks with bail diameter 5 ... 8 mm, door interlock in ON position defeatable, for use with 6 mm OXS6...types up to 180 mm or driver shafts MSOX.

Black	MSHD-LTB ¹⁾	1SAM201920R1011	1	0.065
Yellow	MSHD-LTY ¹⁾	1SAM201920R1012	1	0.065

¹⁾ Indication I-O-T and ON-OFF-T

Description	Type	Order code	Pkg qty	Weight (1 pce) kg
-------------	------	------------	------------	-------------------------

Driver

Coupling driver for use with 6 mm OXS6... types up to 180 mm.

MSMN ¹⁾	1SAM101923R0002	1	0.002
MSMNO ²⁾	1SAM101923R0012	1	0.002

¹⁾ Coded - Positioning of ON indication dependent from mounting orientation of the MS

²⁾ Uncoded - Positioning of ON indication independent from mounting orientation of the MS

Description	Shaft length mm	Type	Order code	Pkg qty	Weight (1 pce) kg
-------------	--------------------	------	------------	------------	-------------------------

Driver shafts

Driver shaft - combination driver & shaft. Shaft diameter 6 mm.

32	MSOX-32 ¹⁾	1SAM101924R0003	1	0.010
30	MSOX-30 ²⁾	1SAM101924R0013	1	0.010

¹⁾ MSOX-32 is for normal vertical use

²⁾ MSOX-30 is for horizontal use

MS325 manual motor starters

0.10 to 25 A – with thermal and electromagnetic protection

2



MS325-16

Description

Manual motor starters (MMS) are protection devices for the main circuit. They combine motor control and protection in a single device. MMS are used mainly to switch motors manually ON/OFF and protect them and the installation fuse less against short-circuit, overload and phase failures. Fuse less protection with a manual motor starter saves costs, space and ensures a quick reaction under short-circuit condition, by switching off the motor within milliseconds.

MS325 is a compact and powerful range for motor protection up to 12.5 kW (400 V) / 25 A in width of 54 mm. Further features are the build-in disconnect function, temperature compensation, trip-free mechanism and a rotary handle with a clear switch position indication. The manual motor starters are suitable for three- and single-phase applications. Auxiliary contacts, signalling contacts, undervoltage releases, shunt trips, three-phase busbars, power in-feed blocks are available as accessories.

Ordering details

Rated operational power 400 V AC-3	Setting range	Short-circuit breaking capacity I_{cs} at 400 V AC	Rated instantaneous short-circuit current setting I_i	Type	Order code	Weight (1 pce)
kW	A	kA	A			kg
0.03	0.10 ... 0.16	100	1.56	MS325-0.16	1SAM150000R1001	0.280
0.06	0.16 ... 0.25	100	2.44	MS325-0.25	1SAM150000R1002	0.280
0.09	0.25 ... 0.40	100	3.9	MS325-0.4	1SAM150000R1003	0.280
0.12	0.40 ... 0.63	100	6.14	MS325-0.63	1SAM150000R1004	0.280
0.25	0.63 ... 1.00	100	11.5	MS325-1	1SAM150000R1005	0.310
0.55	1.00 ... 1.60	100	18.4	MS325-1.6	1SAM150000R1006	0.340
0.75	1.60 ... 2.50	100	28.75	MS325-2.5	1SAM150000R1007	0.340
1.5	2.50 ... 4.00	100	50	MS325-4	1SAM150000R1008	0.340
2.2	4.00 ... 6.30	100	78.75	MS325-6.3	1SAM150000R1009	0.340
4.0	6.30 ... 9.00	100	135	MS325-9	1SAM150000R1010	0.340
5.5	9.00 ... 12.5	75	180	MS325-12.5	1SAM150000R1011	0.340
7.5	12.5 ... 16.0	60	240	MS325-16	1SAM150000R1012	0.340
9.0	16.0 ... 20.0	55	300	MS325-20	1SAM150000R1013	0.340
12.5	20.0 ... 25.0	50	375	MS325-25	1SAM150000R1014	0.340
0.03	0.10 ... 0.16	100	1.56	MS325-0.16-HKF11	1SAM150005R0001	0.300
0.06	0.16 ... 0.25	100	2.44	MS325-0.25-HKF11	1SAM150005R0002	0.300
0.09	0.25 ... 0.40	100	3.9	MS325-0.4-HKF11	1SAM150005R0003	0.300
0.12	0.40 ... 0.63	100	6.14	MS325-0.63-HKF11	1SAM150005R0004	0.300
0.25	0.63 ... 1.00	100	11.5	MS325-1-HKF11	1SAM150005R0005	0.330
0.55	1.00 ... 1.60	100	18.4	MS325-1.6-HKF11	1SAM150005R0006	0.360
0.75	1.60 ... 2.50	100	28.75	MS325-2.5-HKF11	1SAM150005R0007	0.360
1.5	2.50 ... 4.00	100	50	MS325-4-HKF11	1SAM150005R0008	0.360
2.2	4.00 ... 6.30	100	78.75	MS325-6.3-HKF11	1SAM150005R0009	0.360
4.0	6.30 ... 9.00	100	135	MS325-9-HKF11	1SAM150005R0010	0.360
5.5	9.00 ... 12.5	75	180	MS325-12.5-HKF11	1SAM150005R0011	0.360
7.5	12.5 ... 16.0	60	240	MS325-16-HKF11	1SAM150005R0012	0.360
9.0	16.0 ... 20.0	55	300	MS325-20-HKF11	1SAM150005R0013	0.360
12.5	20.0 ... 25.0	50	375	MS325-25-HKF11	1SAM150005R0014	0.360

Main dimensions mm, inches

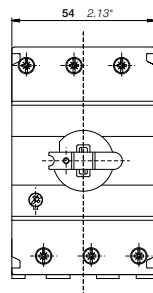

MS325

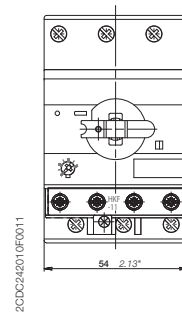
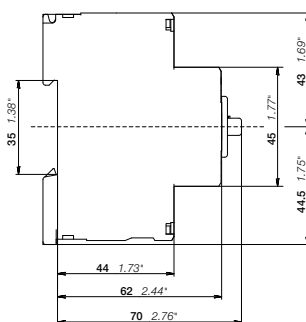

MS325 + HKF11

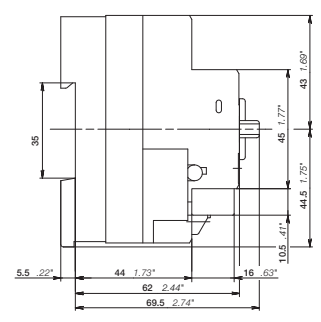

MS325 manual motor starters

Technical data

Main circuit – Utilization characteristics according to IEC/EN

Type	MS325
Standards	IEC/EN 60947-2, IEC/EN 60947-4-1, IEC/EN 60947-1
Rated operational voltage U_e	690 V AC / 440 V DC
Rated frequency	50/60 Hz
Trip class	10A
Number of poles	3
Duty time	100 %
Rated impulse withstand voltage U_{imp}	6 kV
Rated insulation voltage U_i	690 V AC
Rated operational current I_e	See ordering details
Rated instantaneous short-circuit current setting I_i	See ordering details
Rated service short-circuit breaking capacity I_{cs}	See table "Short-circuit breaking capacity and back-up fuses"
Rated ultimate short-circuit breaking capacity I_{cu}	See table "Short-circuit breaking capacity and back-up fuses"

Short-circuit breaking capacity and back-up fuses

I_{cs} Rated service short-circuit breaking capacity

I_{cu} Rated ultimate short-circuit breaking capacity

I_{cc} Prospective short-circuit current at installation location

Note: Maximum rated current of the back-up fuses if $I_{cc} > I_{cs}$

Type	230 V AC			400 V AC			440 V AC			500 V AC			690 V AC		
	I_{cs} kA	I_{cu} kA	gG, aM A	I_{cs} kA	I_{cu} kA	gG, aM A	I_{cs} kA	I_{cu} kA	gG, aM A	I_{cs} kA	I_{cu} kA	gG, aM A	I_{cs} kA	I_{cu} kA	gG, aM A
MS325-0.16															
MS325-0.25															
MS325-0.4															
MS325-0.63															
MS325-1															
MS325-1.6															
MS325-2.5													40	40	25
MS325-4											60	60	40	10	40
MS325-6.3							70	70	50		40	40	50	7	40
MS325-9							50	50	80		30	30	80	5	50
MS325-12.5				75	75	80	45	45	80		27	27	80	4.5	50
MS325-16				60	60	100	40	40	100		25	25	100	4	50
MS325-20				55	55	100	35	35	100		22	22	100	3.5	50
MS325-25				50	50	125	30	30	125		20	20	125	3	50

MS325-9: No need for back-up fuse in networks with a prospective current of up to 100 kA at 400 V.

MS325-16: No need for back-up fuse in networks with a prospective current of up to 60 kA at 400 V.

With an appropriate 100 A type gG fuse the device can be used in a network with a prospective current of up to 100 kA

MS325 manual motor starters

Technical data

Main circuit – Utilization characteristics according to UL/CSA

Type	MS325	
Standards	UL 508, CSA 22.2 No. 14	
Maximum operational voltage	600 V AC	
Manual motor controller ratings	See table "UL 508 – Manual motor controller"	
Trip rating	125 % FLA	
Motor ratings	Horse power	See table "Motor rating, three phase"
	Full load amps (FLA)	See table "Motor rating, three phase"
	Locked rotor amps (LRA)	See table "Motor rating, three phase"

Motor rating, three phase

hp Horse power

FLA Full load amps

LRA Locked rotor amps

Type	220-240 V AC			440-480 V AC			500-600 V AC		
	hp	FLA	LRA	hp	FLA	LRA	hp	FLA	LRA
MS325-0.16	-	0.16	0.96	-	0.16	0.96	-	0.16	0.96
MS325-0.25	-	0.25	1.5	-	0.25	1.5	-	0.25	1.5
MS325-0.4	-	0.4	2.4	-	0.4	2.4	-	0.4	2.4
MS325-0.63	-	0.63	3.78	-	0.63	3.78	-	0.63	3.78
MS325-1	-	1.0	6.0	1/2	1.1	10.0	1/2	0.9	8.0
MS325-1.6	-	1.6	9.6	3/4	1.6	12.5	3/4	1.3	10.0
MS325-2.5	1/2	2.2	20.0	1	2.1	15.0	1-1/2	2.4	16.0
MS325-4	1	4.2	30.0	2	3.4	25.0	3	3.9	25.6
MS325-6.3	1-1/2	6.0	40.0	3	4.8	32.0	5	6.1	36.8
MS325-9	2-1/2	-	-	5	7.6	46.0	7-1/2	9.0	50.8
MS325-12.5	3	9.6	64.0	7-1/2	11.0	63.5	10	11.0	64.8
MS325-16	5	15.2	92.0	10	14.0	81.0	10	11.0	64.8
MS325-20	5	15.2	92.0	10	14.0	81.0	15	27.0	93.0
MS325-25	7-1/2	22.0	127.0	15	21.0	116.0	20	35.0	116.0

UL 508 – Manual motor controller

Type	Max. Circuit Breaker UL/NEC		Max. fuse type UL/NEC	Maximum fuse type K5 o. RK5 per UL/NEC	Maximum short-circuit current for motor disconnect ¹⁾		for group installation		for Tap Conductor Protection 480Y/277V	UL 508 Type E 480Y/277V
	480 V	600 V			480 V	600 V	480 V	600 V		
	A	A	kA	kA	kA	kA	kA	kA		
MS325-0.16	-	S7H1200	1600 (class L)	1200	85	50	85	50	18	18
MS325-0.25	-	S7H1200	1600 (class L)	1200	85	50	85	50	18	18
MS325-0.4	-	S7H1200	1600 (class L)	1200	85	50	85	50	18	18
MS325-0.63	-	S7H1200	1600 (class L)	1200	85	50	85	50	18	18
MS325-1	-	S7H1200	1600 (class L)	1200	85	50	85	50	18	18
MS325-1.6	-	S7H1200	1600 (class L)	1200	85	50	85	50	18	18
MS325-2.5	-	S7H1200	1600 (class L)	1200	85	50	85	50	18	18
MS325-4	-	S7H1200	1600 (class L)	1200	85	50	85	50	18	18
MS325-6.3	S7H1200	S7H1200	600 (class K5)	1200	50	50	50	50	18	18
MS325-9	S7H1200	S4H2500	600 (class K5)	250	50	50	50	50	18	18
MS325-12.5	S4H250	S7H1200	400 (class K5)	1200	50	30	50	30	18	18
MS325-16	S4H250	S7H1200	400 (class K5)	1200	50	30	50	30	18	18
MS325-20	S4H250	S4H250	400 (class K5)	250	50	30	50	30	18	18
MS325-25	S4H250	S4H250	400 (class K5)	250	50	30	50	30	18	18

¹⁾ Suitable as motor disconnect only when provided with padlock SA1 or SA3...



MS325 manual motor starters

Technical data

General technical data

Type	MS325	
Pollution degree	3	
Phase loss sensitive	Yes	
Ambient air temperature		
Operation	Open - compensated without derating	-25 ... +70 °C
	Open	-25 ... +70 °C
	Enclosed (IB325)	0 ... +40 °C
Storage	-50 ... +80 °C	
Ambient air temperature compensation	Continuous	
Maximum operating altitude permissible	2000 m	
Resistance to shock acc. to IEC 60068-2-27	15 g / 1/2 sinusoidal shock for 11 ms	
Resistance to vibrations acc. to IEC 60068-2-6	5 g / 3 ... 150 Hz	
Mounting position	Position 1-6 (optional for single mounting)	
Mounting	DIN-rail (EN 60715)	
Minimum distance to other units same type	Horizontal	0 mm
	Vertical	100 mm
Minimum distance to electrical conductive board	Horizontal, up to 400 V	> 1.5 mm
	Horizontal, up to 690 V	> 1.5 mm
	Vertical	75 mm
Degree of protection	Enclosure / terminals	IP20

Connecting characteristics

Main circuit		
Type	MS325	
Connecting capacity		
 Solid	1 x	1 x 1 ... 10 mm ²
	2 x	2 x 1 ... 6 mm ²
 Flexible	1 x	1 x 1 ... 6 mm ²
	2 x	2 x 0.75 ... 4 mm ²
	1 or 2 x	AWG 14-8
Stranded acc. to UL/CSA		
Flexible acc. to UL/CSA	1 or 2 x	AWG 14-8
Stripping length	10 mm	
Tightening torques	1.4 Nm / 14 lb.in	
Connection screw	M3.5 (Pozidriv 2)	

MS325 manual motor starters

Main accessories

2



SKC108B91

SA1



SKC108B91

SA2



SKC110B91

SA3

Description

Three-phase busbars ensure a quick and safe connection and are therefore a cost effective solution. A variety of different three-phase busbars up to 63 A are in the assortment. Between 2 and 5 manual motor starters with none, one or two lateral auxiliary contacts can be connected. Different three-phase feeder terminals are available according to the application.

Ordering details

Rated operational current A	Number of MMS	Number of lateral aux.	Type	Order code	Pkg qty	Weight (1 pce) kg
--------------------------------	---------------	------------------------	------	------------	---------	----------------------

Three-phase busbars

63	2	0	PS3-2-0	1SAM101937R0012	10	0.038
63	3	0	PS3-3-0	1SAM101937R0013	10	0.062
63	4	0	PS3-4-0	1SAM101937R0014	10	0.087
63	5	0	PS3-5-0	1SAM101937R0015	10	0.115
63	6	0	PS3-6-0	1SAM101937R0016	10	0.137
63	2	1	PS3-2-1	1SAM101937R0022	10	0.040
63	3	1	PS3-3-1	1SAM101937R0023	10	0.068
63	4	1	PS3-4-1	1SAM101937R0024	10	0.097
63	5	1	PS3-5-1	1SAM101937R0025	10	0.126
63	3	2	PS3-2-2	1SAM101937R0032	10	0.043
63	4	2	PS3-4-2	1SAM101937R0034	10	0.106

Rated operational current A	Rated cross section mm ²	Mounting form	Type	Order code	Pkg qty	Weight (1 pce) kg
--------------------------------	--	---------------	------	------------	---------	----------------------

Three-phase feeder terminals

63	25	Flat	S3-M1	1SAM101938R0001	10	0.041
63	25	High	S3-M2	1SAM101938R0002	10	0.053
63	35	UL type E and IEC	S3-M3	1SAM101938R0004	10	0.050

Description	Type	Order code	Pkg qty	Weight (1 pce) kg
Protection cover for busbars	BS3-3	1SAM101938R0003	50	0.001
Lock handle	SA1	GJF1101903R0001	10	0.003
Padlock	SA2	GJF1101903R0002	10	0.020
Lock handle box SA1/SA2	SA3	GJF1101903R0003	10	0.050

MS325 manual motor starters

Main accessories



HKF



HK



SK

Description

MS325 manual motor starters can be equipped with auxiliary contacts for lateral/front mounting, signalling contact for lateral mounting, undervoltage release and shunt trips. A variety of combinations is possible as required for the application. The auxiliary contacts change position with the main contacts. The signalling contact signals tripping regardless if it was caused by short-circuit or overload. Undervoltage release are used for remote tripping of the manual motor starter especially for emergency stop circuits. Shunt trips release the MMS used for remote tripping

Ordering details

Auxiliary contacts: N.O.	Auxiliary contacts: N.C.	Description	Type	Order code	Pkg qty	Weight (1 pce)
--------------------------	--------------------------	-------------	------	------------	---------	----------------

Auxiliary contacts – mountable on the front

1	1		HKF-11	1SAM101928R0001	10	0.015
2	0		HKF-20	1SAM101928R0002	10	0.020

Auxiliary contacts – mountable on the left

1	1	Max. 2 pieces	HK-11	1SAM101901R0001	2	0.030
2	0	Max. 2 pieces	HK-20	1SAM101901R0002	2	0.030
0	2	Max. 2 pieces	HK-02	1SAM101901R0003	2	0.030

Signalling contacts – mountable on the left

1	1	For tripped alarm, max. 1 pieces	SK-11	1SAM101904R0003	10	0.030
---	---	----------------------------------	-------	-----------------	----	-------

Signalling contacts – mountable on the right

1	1	For short-circuit alarm	CK-11	1SAM101943R0001	10	0.035
---	---	-------------------------	-------	-----------------	----	-------

Rated control supply voltage	Frequency	Type	Order code	Pkg qty	Weight (1 pce)
V	Hz				kg

Shunt trip units – mountable as slide in

24 ... 60	50/60	AA-24	1SAM101909R0001	10	0.025
110 ... 240	50/60	AA-230	1SAM101909R0002	10	0.025
220 ... 415	50/60	AA-400	1SAM101909R0003	10	0.025

Undervoltage releases – mountable as slide in

24	50	UAF-24	1SAM101903R0024	10	0.02
48	50	UAF-48	1SAM101903R0048	10	0.02
60	50	UAF-60	1SAM101903R0060	10	0.02
110	50	UAF-110	1SAM101903R0110	10	0.02
230	50	UAF-230	1SAM101903R0230	10	0.02
400	50	UAF-400	1SAM101903R0400	10	0.02
415	50	UAF-415	1SAM101903R0415	10	0.02
500	50	UAF-500	1SAM101903R0500	10	0.02

MS325 manual motor starters



Main accessories

General technical data

Type	PS3	S3-M1/S3-M2	S3-M3
Standards	IEC/EN 60947-2, IEC/EN 60947-4-1, IEC/EN 60947-1		
Rated operational voltage U_o	690 V AC		
Rated operational current I_o	63 A		
Rated frequency	50/60 Hz		
Rated impulse withstand voltage U_{imp}	6 kV		
Rated insulation voltage U_i	690 V AC		
Pollution degree	3		
Cross-section	10 mm ²	25 mm ²	
Ambient air temperature	Operation	-25 ... +70 °C	
	Storage	-50 ... +80 °C	
Resistance to shock acc. to IEC 60068-2-27	15 g / 11 ms		
Resistance to vibrations acc. to IEC 60068-2-6	3 g / 3 ... 150 Hz		

Electrical connection

Main circuit

Type	PS3, S3-Mx
Connecting capacity	
 Solid	1 x : 6 ... 25 mm ²
 Flexible	1 x : 6 ... 16 mm ²
Stranded acc. to UL/CSA	1 x : AWG 10-4
Flexible acc. to UL/CSA	1 x : AWG 10-6
Stripping length	10 mm
Tightening torques	2.5 Nm / 22 lb.in
Connection screw	PZ2 (6 mm)

MS325 manual motor starters

Main accessories



IB325-Y

2CDC241004F0010



IB325-G

2CDC241003F0010



DMS325-Y

2CDC241002F0010



DMS325-G

2CDC241001F0010

Description

IB325 are IP65 enclosures for single MMS installation. Additional mounting of auxiliary and signalling contacts, shunt trips and undervoltage release is possible. The handle is lockable in OFF position. For detailed specification see installation instruction.

DMS325 are IP65 door mounting kits for MMS installation in any enclosure. Additional mounting of auxiliary, signalling, shunt trips and undervoltage release is possible. The handle is lockable in OFF position. For detailed specification see installation instruction.

Ordering details

Description	Color	Type	Order code	Pkg qty	Weight (1 pce) kg
Enclosures IP65					
Padlockable max. 3 padlocks with bail diameter 4 ... 6.5 mm	Yellow/red	IB325-G	1SAM101940R1000	1	0.370
	Grey/black	IB325-Y	1SAM101940R1001	1	0.370
Door mounting kit IP65					
Padlockable max. 3 padlocks with bail diameter 4 ... 6.5 mm	Yellow/red	DMS325-G	1SAM101941R1000	1	0.170
	Grey/black	DMS325-Y	1SAM101941R1001	1	0.170

Indication I-O and ON-OFF

Main dimensions mm, inches

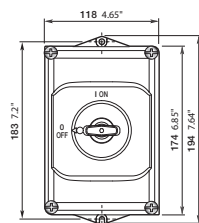

IB325

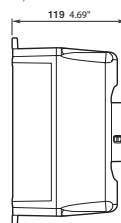

2CDC242011F0011

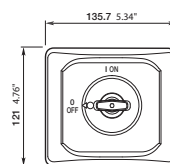

DMS325

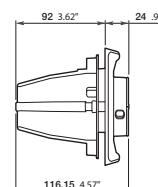

2CDC242012F0011

2CDC131041C0201

MS325 manual motor starters

Main accessories

2



2CDC241003R0011

MSHD-LB



2CDC241002F0011

MSHD-LY



2CDC241004S0011

MSMN

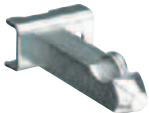

2CDC241005S0011

MSOX-30

Description

The complete set includes handle, shaft and driver. All accessories fit 6 mm shafts of maximum 180 mm length. The degree of protection for handles MSHD is IP64.

Ordering details

Description	Shaft length mm	Type	Order code	Pkg qty	Weight (1 pce) kg
-------------	--------------------	------	------------	------------	-------------------------

Shafts

For selector type handles. Shaft diameter 6 mm. Shaft extension for door coupling driver.

85	OXS6X85	1SCA101647R1001	1	0.020
105	OXS6X105	1SCA108043R1001	1	0.020
130	OXS6X130	1SCA101655R1001	1	0.030
180	OXS6X180	1SCA101659R1001	1	0.040

Description	Color	Type	Order code	Pkg qty	Weight (1 pce) kg
-------------	-------	------	------------	------------	-------------------------

Selector type handles IP64

Padlockable max. 3 padlocks with bail diameter 5 ... 8 mm, door interlock in ON position defeatable, for use with 6 mm OXS6...types up to 180 mm or driver shafts MSOX.

Black	MSHD-LB ¹⁾	1SAM201920R1001	1	0.065
Yellow	MSHD-LY	1SAM201920R1002	1	0.065

¹⁾ Indication I-O and ON-OFF

Description	Type	Order code	Pkg qty	Weight (1 pce) kg
-------------	------	------------	------------	-------------------------

Driver

Coupling driver for use with 6 mm OXS6... types up to 180 mm.

MSMN ¹⁾	1SAM101923R0002	1	0.002
MSMNO ²⁾	1SAM101923R0012	1	0.002

¹⁾ Coded - Positioning of ON indication dependent from mounting orientation of the MS

²⁾ Uncoded - Positioning of ON indication independent from mounting orientation of the MS

Description	Shaft length mm	Type	Order code	Pkg qty	Weight (1 pce) kg
-------------	--------------------	------	------------	------------	-------------------------

Driver shafts

Driver shaft - combination driver & shaft. Shaft diameter 6 mm.

32	MSOX-32 ¹⁾	1SAM101924R0003	1	0.010
30	MSOX-30 ²⁾	1SAM101924R0013	1	0.010

¹⁾ MSOX-32 is for normal vertical use

²⁾ MSOX-30 is for horizontal use

MO325 manual motor starters magnetic only

0.4 to 25 A – with electromagnetic protection



MO325-16

2CDC241003R0009

Description

The MO325 manual motor starters magnetic only are 54 mm width devices. These devices are used to manually switch on and off motors and to protect them reliably and without the need for a fuse from short-circuits.

Further features are the build-in disconnect function, trip-free mechanism and a rotary handle with a clear switch position indication. The manual motor starter magnetic only is suitable for three- and single-phase applications. Auxiliary contacts, signalling contacts, undervoltage releases, shunt trips, three-phase busbars, power in-feed blocks are available as accessory.

Ordering details

Rated operational power 400 V AC-3 ¹⁾ kW	Rated operational current A	Short-circuit breaking capacity I _{CS} at 400 V AC kA	Rated instantaneous short-circuit current setting I _n A	Type	Order code	Weight (1 pce) kg
0.09	0.40	100	3.9	MO325-0.4	1SAM160000R1003	0.280
0.12	0.63	100	6.14	MO325-0.63	1SAM160000R1004	0.280
0.25	1.0	100	11.5	MO325-1	1SAM160000R1005	0.310
0.55	1.6	100	18.4	MO325-1.6	1SAM160000R1006	0.340
0.75	2.5	100	28.75	MO325-2.5	1SAM160000R1007	0.340
1.5	4.0	100	50	MO325-4	1SAM160000R1008	0.340
2.2	6.3	100	78.75	MO325-6.3	1SAM160000R1009	0.340
4.0	9.0	100	135	MO325-9	1SAM160000R1010	0.340
5.5	12.5	75	180	MO325-12.5	1SAM160000R1011	0.340
7.5	16	60	240	MO325-16	1SAM160000R1012	0.340
9.0	20	55	300	MO325-20	1SAM160000R1013	0.340
12.5	25	50	375	MO325-25	1SAM160000R1014	0.340

¹⁾ For overload protection of motors, an appropriate thermal or electronic overload relay must be used

Main dimensions mm, inches

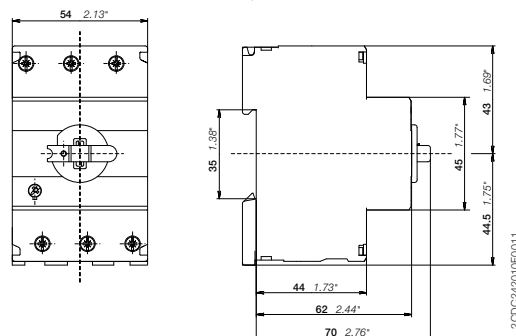

MO325

2CDC24201R00011

MO325 manual motor starters magnetic only

Technical data

2

Main circuit – Utilization characteristics according to IEC/EN

Type	MO325
Standards	IEC/EN 60947-2, IEC/EN 60947-4-1, IEC/EN 60947-1
Rated operational voltage U_e	690 V AC / 440 V DC
Rated frequency	50/60 Hz
Number of poles	3
Duty time	100 %
Rated impulse withstand voltage U_{imp}	6 kV
Rated insulation voltage U_i	690 V AC
Rated operational current I_e	See ordering details
Rated instantaneous short-circuit current setting I_i	See ordering details
Rated service short-circuit breaking capacity I_{cs}	See table "Short-circuit breaking capacity and back-up fuses"
Rated ultimate short-circuit breaking capacity I_{cu}	See table "Short-circuit breaking capacity and back-up fuses"

Short-circuit breaking capacity and back-up fuses

I_{cs} Rated service short-circuit breaking capacity

I_{cu} Rated ultimate short-circuit breaking capacity

I_{cc} Prospective short-circuit current at installation location

Note: Maximum rated current of the back-up fuses if $I_{cc} > I_{cs}$

Type	230 V AC			400 V AC			440 V AC			500 V AC			690 V AC		
	I_{cs} kA	I_{cu} kA	gG, aM A	I_{cs} kA	I_{cu} kA	gG, aM A	I_{cs} kA	I_{cu} kA	gG, aM A	I_{cs} kA	I_{cu} kA	gG, aM A	I_{cs} kA	I_{cu} kA	gG, aM A
MO325-0.4															
MO325-0.63															
MO325-1															
MO325-1.6															
MO325-2.5															
MO325-4															
MO325-6.3													40	40	25
MO325-9										60	60	40	10	10	40
MO325-12.5							70	70	50	40	40	50	7	7	40
MO325-16							50	50	80	30	30	80	5	5	50
MO325-20				75	75	80	45	45	80	27	27	80	4.5	4.5	50
MO325-25				60	60	100	40	40	100	25	25	100	4	4	50

MO325-9: No need for back-up fuse in networks with a prospective current of up to 100 kA at 400 V.

MO325-16: No need for back-up fuse in networks with a prospective current of up to 60 kA at 400 V.

With an appropriate 100 A type gG fuse the device can be used in a network with a prospective current of up to 100 kA



MO325 manual motor starters magnetic only

Technical data

General technical data

Type	MO325	
Pollution degree	3	
Phase loss sensitive	Yes	
Ambient air temperature		
Operation	Open - compensated without derating	-25 ... +70 °C
	Open	-25 ... +70 °C
	Enclosed (IB132)	0 ... +40 °C
Storage	-50 ... +80 °C	
Ambient air temperature compensation	Continuous	
Maximum operating altitude permissible	2000 m	
Resistance to shock acc. to IEC 60068-2-27	15 g / 1/2 sinusoidal shock for 11 ms	
Resistance to vibrations acc. to IEC 60068-2-6	5 g / 3 ... 150 Hz	
Mounting position	Position 1-6 (optional for single mounting)	
Group mounting		
Minimum distance to other units same type	Horizontal	0 mm
	Vertical	100 mm
Minimum distance to electrical conductive board	Horizontal, up to 400 V	> 1.5 mm
	Horizontal, up to 690 V	> 1.5 mm
	Vertical	75 mm
Degree of protection	Enclosure / terminals	IP20

Connecting characteristics

Main circuit			
Type	MO325		
Connecting capacity			
 Solid	1 x	1 x 1 ... 10 mm ²	
	2 x	2 x 1 ... 6 mm ²	
 Flexible	1 x	1 x 1 ... 6 mm ²	
	2 x	2 x 0.75 ... 4 mm ²	
	1 or 2 x	AWG 14-8	Stranded acc. to UL/CSA
	1 or 2 x	AWG 14-8	Flexible acc. to UL/CSA
Stripping length	10 mm		
Tightening torques	1.4 Nm / 14 lb.in		
Connection screw	M3.5 (Pozidriv 2)		

MO325 manual motor starters magnetic only

Main accessories

2



SKO10B91

SA1



SKO10B91

SA2



SKO110B91

SA3

Description

Three-phase busbars ensure a quick and safe connection and are therefore a cost effective solution. A variety of different three-phase busbars up to 63 A are in the assortment. Between 2 and 5 manual motor starters with none, one or two lateral auxiliary contacts can be connected. Different three-phase feeder terminals are available according to the application.

Ordering details

Rated operational current A	Number of MMS	Number of lateral aux.	Type	Order code	Pkg qty	Weight (1 pce) kg
--------------------------------	---------------	------------------------	------	------------	---------	----------------------

Three-phase busbars

63	2	0	PS3-2-0	1SAM101937R0012	10	0.038
63	3	0	PS3-3-0	1SAM101937R0013	10	0.062
63	4	0	PS3-4-0	1SAM101937R0014	10	0.087
63	5	0	PS3-5-0	1SAM101937R0015	10	0.115
63	6	0	PS3-6-0	1SAM101937R0016	10	0.137
63	2	1	PS3-2-1	1SAM101937R0022	10	0.040
63	3	1	PS3-3-1	1SAM101937R0023	10	0.068
63	4	1	PS3-4-1	1SAM101937R0024	10	0.097
63	5	1	PS3-5-1	1SAM101937R0025	10	0.126
63	3	2	PS3-2-2	1SAM101937R0032	10	0.043
63	4	2	PS3-4-2	1SAM101937R0034	10	0.106

Rated operational current A	Rated cross section mm ²	Mounting form	Type	Order code	Pkg qty	Weight (1 pce) kg
--------------------------------	--	---------------	------	------------	---------	----------------------

Three-phase feeder terminals

63	25	Flat	S3-M1	1SAM101938R0001	10	0.041
63	25	High	S3-M2	1SAM101938R0002	10	0.053
63	35	UL type E and IEC	S3-M3	1SAM101938R0004	10	0.050

Description	Type	Order code	Pkg qty	Weight (1 pce) kg
Protection cover for busbars	BS3-3	1SAM101938R0003	50	0.001
Lock handle	SA1	GJF1101903R0001	10	0.003
Padlock	SA2	GJF1101903R0002	10	0.020
Lock handle box SA1/SA2	SA3	GJF1101903R0003	10	0.050

MO325 manual motor starters magnetic only

Main accessories



HKF



HK



SK

Description

MS325 manual motor starters can be equipped with auxiliary contacts for lateral/front mounting, signalling contact for lateral mounting, undervoltage release and shunt trips. A variety of combinations is possible as required for the application. The auxiliary contacts change position with the main contacts. The signalling contact signals tripping regardless if it was caused by short-circuit or overload. Undervoltage release are used for remote tripping of the manual motor starter especially for emergency stop circuits. Shunt trips release the MMS used for remote tripping

Ordering details

Auxiliary contacts: N.O.	Auxiliary contacts: N.C.	Description	Type	Order code	Pkg qty	Weight (1 pce) kg
--------------------------	--------------------------	-------------	------	------------	---------	-------------------

Auxiliary contacts – mountable on the front

1	1		HKF-11	1SAM101928R0001	10	0.015
2	0		HKF-20	1SAM101928R0002	10	0.020

Auxiliary contacts – mountable on the left

1	1	Max. 2 pieces	HK-11	1SAM101901R0001	2	0.030
2	0	Max. 2 pieces	HK-20	1SAM101901R0002	2	0.030
0	2	Max. 2 pieces	HK-02	1SAM101901R0003	2	0.030

Signalling contacts – mountable on the left

1	1	For tripped alarm, max. 1 pieces	SK-11	1SAM101904R0003	10	0.030
---	---	----------------------------------	-------	-----------------	----	-------

Signalling contacts – mountable on the right

1	1	For short-circuit alarm	CK-11	1SAM101943R0001	10	0.035
---	---	-------------------------	-------	-----------------	----	-------

Rated control supply voltage	Frequency	Type	Order code	Pkg qty	Weight (1 pce) kg
V	Hz				

Shunt trip units – mountable as slide in

24 ... 60	50/60	AA-24	1SAM101909R0001	10	0.025
110 ... 240	50/60	AA-230	1SAM101909R0002	10	0.025
220 ... 415	50/60	AA-400	1SAM101909R0003	10	0.025

Undervoltage releases – mountable as slide in

24	50	UAF-24	1SAM101903R0024	10	0.02
48	50	UAF-48	1SAM101903R0048	10	0.02
60	50	UAF-60	1SAM101903R0060	10	0.02
110	50	UAF-110	1SAM101903R0110	10	0.02
230	50	UAF-230	1SAM101903R0230	10	0.02
400	50	UAF-400	1SAM101903R0400	10	0.02
415	50	UAF-415	1SAM101903R0415	10	0.02
500	50	UAF-500	1SAM101903R0500	10	0.02

MO325 manual motor starters magnetic only



Main accessories

General technical data

Type	PS3	S3-M1/S3-M2	S3-M3
Standards	IEC/EN 60947-2, IEC/EN 60947-4-1, IEC/EN 60947-1		
Rated operational voltage U_o	690 V AC		
Rated operational current I_o	63 A		
Rated frequency	50/60 Hz		
Rated impulse withstand voltage U_{imp}	6 kV		
Rated insulation voltage U_i	690 V AC		
Pollution degree	3		
Cross-section	10 mm ²	25 mm ²	
Ambient air temperature	Operation	-25 ... +70 °C	
	Storage	-50 ... +80 °C	
Resistance to shock acc. to IEC 60068-2-27	15 g / 11 ms		
Resistance to vibrations acc. to IEC 60068-2-6	3 g / 3 ... 150 Hz		

Electrical connection

Main circuit

Type	PS3, S3-Mx
Connecting capacity	
 Solid	1 x : 6 ... 25 mm ²
 Flexible	1 x : 6 ... 16 mm ²
Stranded acc. to UL/CSA	1 x : AWG 10-4
Flexible acc. to UL/CSA	1 x : AWG 10-6
Stripping length	10 mm
Tightening torques	2.5 Nm / 22 lb.in
Connection screw	PZ2 (6 mm)

MO325 manual motor starters magnetic only

Main accessories



IB325-Y

2CDC241004F0010



IB325-G

2CDC241003F0010



DMS325-Y

2CDC241002F0010



DMS325-G

2CDC241001F0010

Description

IB325 are IP65 enclosures for single MMS installation. Additional mounting of auxiliary and signalling contacts, shunt trips and undervoltage release is possible. The handle is lockable in OFF position. For detailed specification see installation instruction.

DMS325 are IP65 door mounting kits for MMS installation in any enclosure. Additional mounting of auxiliary, signalling, shunt trips and undervoltage release is possible. The handle is lockable in OFF position. For detailed specification see installation instruction.

Ordering details

Description	Color	Type	Order code	Pkg qty	Weight (1 pce) kg
Enclosures IP65					
Padlockable max. 3 padlocks with bail diameter 4 ... 6.5 mm	Yellow/red	IB325-G	1SAM101940R1000	1	0.370
	Grey/black	IB325-Y	1SAM101940R1001	1	0.370
Door mounting kit IP65					
Padlockable max. 3 padlocks with bail diameter 4 ... 6.5 mm	Yellow/red	DMS325-G	1SAM101941R1000	1	0.170
	Grey/black	DMS325-Y	1SAM101941R1001	1	0.170

Indication I-O and ON-OFF

Main dimensions mm, inches

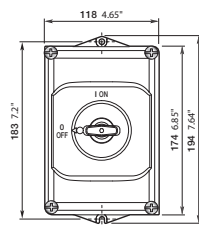

IB325

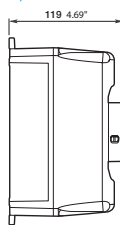

DMS325

2CDC242011F0011

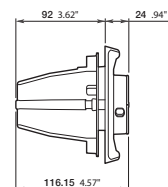

2CDC242012F0011

MO325 manual motor starters magnetic only

Main accessories

2



2CDC241003R0011

MSHD-LB



2CDC241002S0011

MSHD-LY



2CDC241004S0011

MSMN



2CDC241003S0011

MSOX-30

Description

The complete set includes handle, shaft and driver. All accessories fit 6 mm shafts of maximum 180 mm length. The degree of protection for handles MSHD is IP64.

Ordering details

Description	Shaft length mm	Type	Order code	Pkg qty	Weight (1 pce) kg
-------------	--------------------	------	------------	------------	-------------------------

Shafts

For selector type handles. Shaft diameter 6 mm. Shaft extension for door coupling driver.	85	OXS6X85	1SCA101647R1001	1	0.020
	105	OXS6X105	1SCA108043R1001	1	0.020
	130	OXS6X130	1SCA101655R1001	1	0.030
	180	OXS6X180	1SCA101659R1001	1	0.040

Description	Color	Type	Order code	Pkg qty	Weight (1 pce) kg
-------------	-------	------	------------	------------	-------------------------

Selector type handles IP64

Padlockable max. 3 padlocks with bail diameter 5 ... 8 mm, door interlock in ON position defeatable, for use with 6 mm OXS6...types up to 180 mm or driver shafts MSOX.	Black	MSHD-LB ¹⁾	1SAM201920R1001	1	0.065
	Yellow	MSHD-LY ²⁾	1SAM201920R1002	1	0.065

¹⁾ Indication I-O and ON-OFF

²⁾ Indication I-O-T and ON-OFF-T

Description	Type	Order code	Pkg qty	Weight (1 pce) kg
-------------	------	------------	------------	-------------------------

Driver

Coupling driver for use with 6 mm OXS6... types up to 180 mm.	MSMN ¹⁾	1SAM101923R0002	1	0.002
	MSMNO ²⁾	1SAM101923R0012	1	0.002

¹⁾ Coded - Positioning of ON indication dependent from mounting orientation of the MS

²⁾ Uncoded - Positioning of ON indication independent from mounting orientation of the MS

Description	Shaft length mm	Type	Order code	Pkg qty	Weight (1 pce) kg
-------------	--------------------	------	------------	------------	-------------------------

Driver shafts

Driver shaft - combination driver & shaft. Shaft diameter 6 mm.	32	MSOX-32 ¹⁾	1SAM101924R0003	1	0.010
	30	MSOX-30 ²⁾	1SAM101924R0013	1	0.010

¹⁾ MSOX-32 is for normal vertical use

²⁾ MSOX-30 is for horizontal use

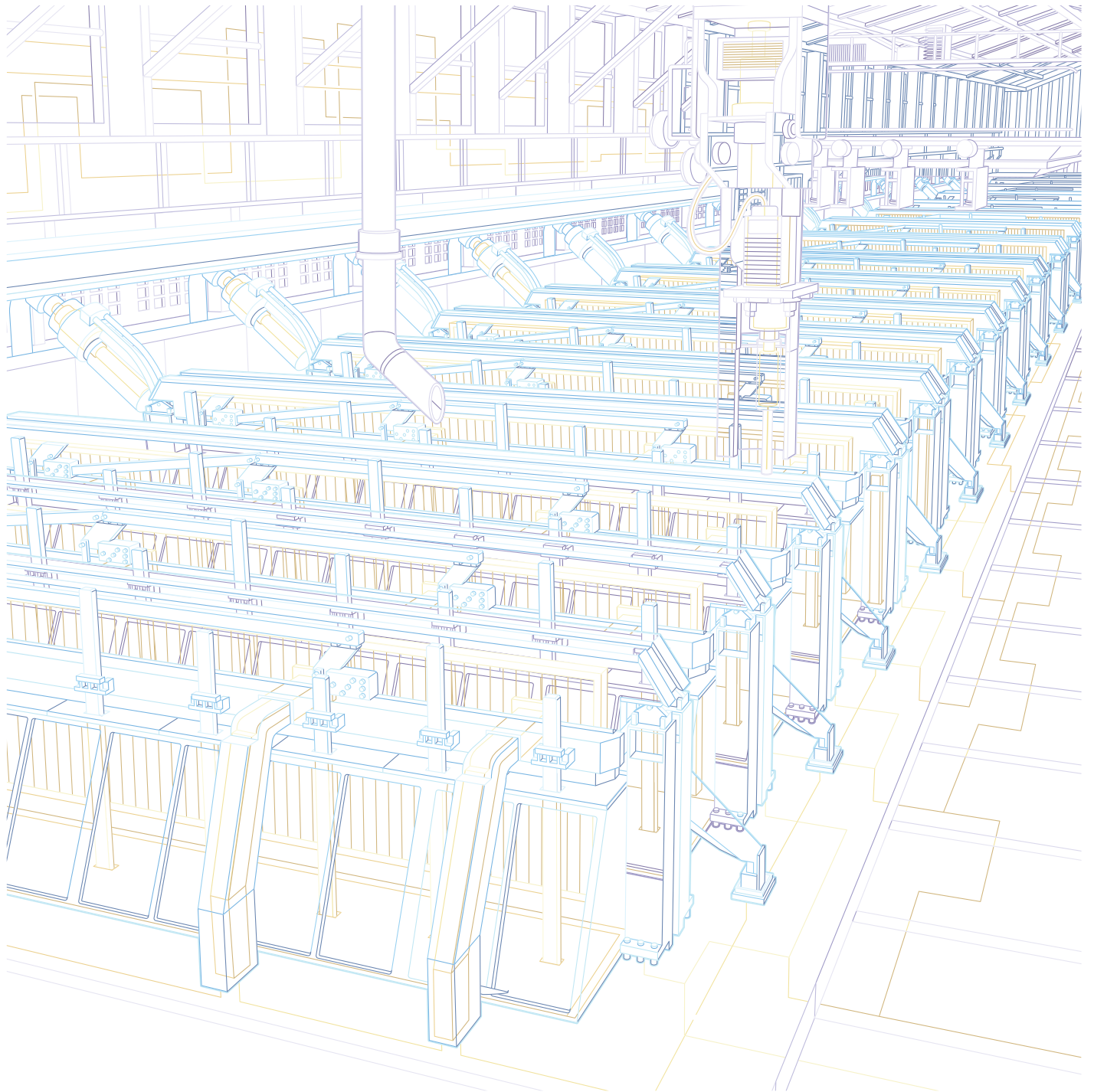



B mini contactors

K mini contactor relays

With screw terminals

3-pole contactors

B6, B7	AC operated	3/2
BC6, BC7, B7D	DC operated	3/3

3-pole reversing contactors

VB6, VB7	AC operated	3/4
VBC6, VBC7	DC operated	3/5

3-pole interface contactors

BC6, BC7	DC operated	3/6
----------	-------------	-----

3-pole contactors - large coil voltage range

TBC7	DC operated	3/7
------	-------------	-----

4-pole contactors

B6, B7	AC operated	3/8
BC6, BC7	DC operated	3/9

4-pole contactors - large coil voltage range

TBC7	DC operated	3/10
------	-------------	------

Contactors relays

K6	AC operated	3/12
KC6	DC operated	3/13

Interface contactor relays

KC6	DC operated	3/14
-----	-------------	------

Contactors relays - large coil voltage range

TKC6	DC operated	3/15
------	-------------	------

With soldering pins

3-pole contactors

B6, B7	AC operated	3/16
BC6, BC7	DC operated	3/17

3-pole reversing contactors

VB6, VB7	AC operated	3/18
VBC6, VBC7	DC operated	3/19

Contactors relays

K6	AC operated	3/20
KC6	DC operated	3/21

3-pole interface contactors

BC6, BC7	DC operated	3/22
----------	-------------	------

Interface contactors relays

KC6	DC operated	3/23
-----	-------------	------

Accessories	3/24
-----------------------------	------

Technical data	3/26
--------------------------------	------

B6, B7 3-pole mini contactors – with screw terminals

4 to 5.5 kW

AC operated



B6-30-10

2CDC211001R0010

3



B7-30-10

2CDC211014F0011

Description

B6, B7 3-pole mini contactors are compact control products mainly used for switching resistive or motor loads up to 690 V AC.

These contactors are designed with:

- 3 main poles and one built-in auxiliary contact
- control circuit: AC operated, low coil consumption (3.5 VA at pull-in and at holding)
- add-on auxiliary contact blocks for front or side mounting and a wide range of accessories
- hum-free coil
- designed for rail or wall mounting

Ordering details

IEC		UL/CSA		Rated control circuit voltage U_c		Auxiliary contacts fitted	Type	Order code	Pkg qty	Weight (1 pce)
Rated operational power	current $\theta \leq 55^\circ\text{C}$	3-phase motor rating	General use rating	50 Hz	60 Hz					
400 V AC-3	AC-1	480 V	600 V AC	V AC	V AC					kg

B6 mini contactors

Rated operational power	current	3-phase motor rating	General use rating	50 Hz	60 Hz	Auxiliary contacts	Type	Order code	Pkg qty	Weight
4	16	3	3.4	24	24	1 0	B6-30-10-01	GJL1211001R0101	10	0.175
						0 1	B6-30-01-01	GJL1211001R0011	10	0.175
				42	42	1 0	B6-30-10-02	GJL1211001R0102	10	0.175
						0 1	B6-30-01-02	GJL1211001R0012	10	0.175
				48	48	1 0	B6-30-10-03	GJL1211001R0103	10	0.175
						0 1	B6-30-01-03	GJL1211001R0013	10	0.175
				110 ... 127	110 ... 127	1 0	B6-30-10-84	GJL1211001R8104	10	0.175
						0 1	B6-30-01-84	GJL1211001R8014	10	0.175
				220 ... 240	220 ... 240	1 0	B6-30-10-80	GJL1211001R8100	10	0.175
						0 1	B6-30-01-80	GJL1211001R8010	10	0.175
				380 ... 415	380 ... 415	1 0	B6-30-10-85	GJL1211001R8105	10	0.175
						0 1	B6-30-01-85	GJL1211001R8015	10	0.175

B7 mini contactors

Rated operational power	current	3-phase motor rating	General use rating	50 Hz	60 Hz	Auxiliary contacts	Type	Order code	Pkg qty	Weight
5.5	20	5	7.6	24	24	1 0	B7-30-10-01	GJL1311001R0101	10	0.175
						0 1	B7-30-01-01	GJL1311001R0011	10	0.175
				42	42	1 0	B7-30-10-02	GJL1311001R0102	10	0.175
						0 1	B7-30-01-02	GJL1311001R0012	10	0.175
				48	48	1 0	B7-30-10-03	GJL1311001R0103	10	0.175
						0 1	B7-30-01-03	GJL1311001R0013	10	0.175
				110 ... 127	110 ... 127	1 0	B7-30-10-84	GJL1311001R8104	10	0.175
						0 1	B7-30-01-84	GJL1311001R8014	10	0.175
				220 ... 240	220 ... 240	1 0	B7-30-10-80	GJL1311001R8100	10	0.175
						0 1	B7-30-01-80	GJL1311001R8010	10	0.175
				380 ... 415	380 ... 415	1 0	B7-30-10-85	GJL1311001R8105	10	0.175
						0 1	B7-30-01-85	GJL1311001R8015	10	0.175

Other types on request

Main dimensions mm, inches

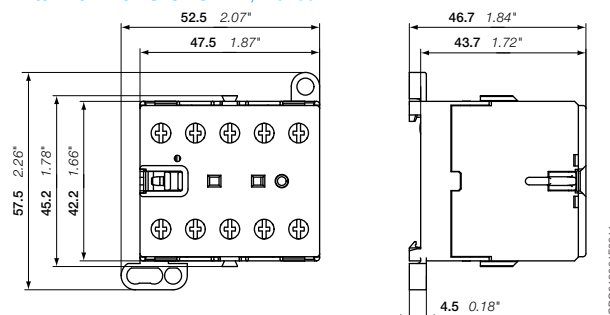

B6, B7

BC6, BC7, B7D 3-pole mini contactors – with screw terminals

4 to 5.5 kW

DC operated



BC6-30-10

2CDC211040R0011



BC7-30-10

2CDC211013R0011

Description

BC6, BC7, B7D 3-pole mini contactors are compact control products mainly used for switching resistive or motor loads up to 690 V AC.

These contactors are designed with:

- 3 main poles and one built-in auxiliary contact
- control circuit: DC operated, low consumption (3.5 W at pull-in and at holding)
- hum-free coil
- add-on auxiliary contact blocks for front or side mounting and a wide range of accessories
- designed for rail or wall mounting

Ordering details

IEC	UL/CSA	Rated operational power	Rated operational current I_n at $\theta \leq 55^\circ\text{C}$	3-phase motor rating	General use rating	Rated control circuit voltage U_c	Auxiliary contacts fitted	Type	Order code	Pkg qty	Weight (1 pce)
4 AC-3 kW	3 hp A	400 V AC-3 kW	A	480 V	600 V AC	V DC	1 0 0 1				kg

BC6 mini contactors

4	16	3	3.4	12	1 0	BC6-30-10-07	GJL1213001R0107	10	0.175
					0 1	BC6-30-01-07	GJL1213001R0017	10	0.175
				24	1 0	BC6-30-10-01	GJL1213001R0101	10	0.175
					0 1	BC6-30-01-01	GJL1213001R0011	10	0.175
				48	1 0	BC6-30-10-16	GJL1213001R1106	10	0.175
					0 1	BC6-30-01-16	GJL1213001R1016	10	0.175
				60	1 0	BC6-30-10-03	GJL1213001R0103	10	0.175
					0 1	BC6-30-01-03	GJL1213001R0013	10	0.175
				110 ... 125	1 0	BC6-30-10-04	GJL1213001R0104	10	0.175
					0 1	BC6-30-01-04	GJL1213001R0014	10	0.175
				220 ... 240	1 0	BC6-30-10-05	GJL1213001R0105	10	0.175
					0 1	BC6-30-01-05	GJL1213001R0015	10	0.175

BC7 mini contactors

5.5	20	5	7.6	12	1 0	BC7-30-10-07	GJL1313001R0107	10	0.175
					0 1	BC7-30-01-07	GJL1313001R0017	10	0.175
				24	1 0	BC7-30-10-01	GJL1313001R0101	10	0.175
					0 1	BC7-30-01-01	GJL1313001R0011	10	0.175
				48	1 0	BC7-30-10-16	GJL1313001R1106	10	0.175
					0 1	BC7-30-01-16	GJL1313001R1016	10	0.175
				60	1 0	BC7-30-10-03	GJL1313001R1103	10	0.175
					0 1	BC7-30-01-03	GJL1313001R0013	10	0.175
				110 ... 125	1 0	BC7-30-10-04	GJL1313001R0104	10	0.175
					0 1	BC7-30-01-04	GJL1313001R0014	10	0.175
				220 ... 240	1 0	BC7-30-10-05	GJL1313001R0105	10	0.175
					0 1	BC7-30-01-05	GJL1313001R0015	10	0.175

B7D mini contactors with integrated suppressor diode

5.5	20	5	7.6	24	1 0	B7D-30-10-01	GJL1317001R0101	10	0.175
					0 1	B7D-30-01-01	GJL1317001R0011	10	0.175
				220	1 0	B7D-30-10-05	GJL1317001R0105	10	0.175
					0 1	B7D-30-01-05	GJL1317001R0015	10	0.175

Other types on request

Main dimensions mm, inches

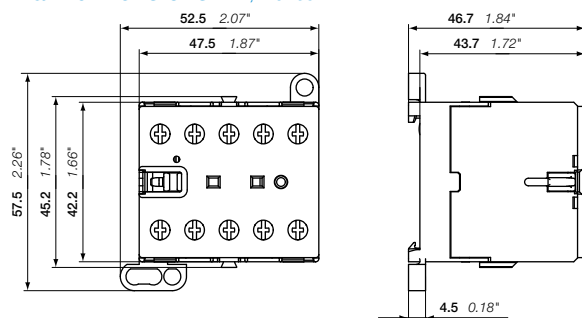

BC6, BC7, B7D

2CDC212001R0011

2CDC102015C0201

VB6, VB7 3-pole mini reversing contactors – with screw terminals

4 to 5.5 kW

AC operated



2CDC211006F0011

VB7-30-10

3

Description

VB6, VB7 3-pole compact design reversing contactors are space optimized control products mainly used for switching resistive or motor loads up to 690 V AC.

These reversing contactors are designed with:

- built-in mechanical interlock. The coils must be mutually interlocked electrically and coils must be de-energised for 50 ms at least to prevent phase to phase short circuit on the arc.
- control circuit: AC operated, low coil consumption (3.5 VA at pull-in and at holding)
- hum-free coil
- add-on auxiliary contact blocks for front mounting
- designed for rail or wall mounting

Ordering details

IEC Rated operational power	UL/CSA 3-phase motor rating 480 V $\theta \leq 55^\circ\text{C}$	General use rating 600 V AC	Rated control circuit voltage U_c		Auxiliary contacts fitted	Type	Order code	Pkg qty	Weight (1 pce)
			50 Hz V AC	60 Hz V AC					
400 V AC-3 kW	AC-1 A	hp	A						kg

VB6 mini reversing contactors

4	16	3	3.4	24	24	1 0	VB6-30-10-01	GJL1211901R0101	5	0.355
						0 1	VB6-30-01-01	GJL1211901R0011	5	0.355
				42	42	1 0	VB6-30-10-02	GJL1211901R0102	5	0.355
						0 1	VB6-30-01-02	GJL1211901R0012	5	0.355
				48	48	1 0	VB6-30-10-03	GJL1211901R0103	5	0.355
						0 1	VB6-30-01-03	GJL1211901R0013	5	0.355
				110 ... 127	110 ... 127	1 0	VB6-30-10-84	GJL1211901R8104	5	0.355
						0 1	VB6-30-01-84	GJL1211901R8014	5	0.355
				220 ... 240	220 ... 240	1 0	VB6-30-10-80	GJL1211901R8100	5	0.355
						0 1	VB6-30-01-80	GJL1211901R8010	5	0.355
				380 ... 415	380 ... 415	1 0	VB6-30-10-85	GJL1211901R8105	5	0.355
						0 1	VB6-30-01-85	GJL1211901R8015	5	0.355

VB7 mini reversing contactors

5.5	20	5	7.6	24	24	1 0	VB7-30-10-01	GJL1311901R0101	5	0.355
						0 1	VB7-30-01-01	GJL1311901R0011	5	0.355
				42	42	1 0	VB7-30-10-02	GJL1311901R0102	5	0.355
						0 1	VB7-30-01-02	GJL1311901R0012	5	0.355
				48	48	1 0	VB7-30-10-03	GJL1311901R0103	5	0.355
						0 1	VB7-30-01-03	GJL1311901R0013	5	0.355
				110 ... 127	110 ... 127	1 0	VB7-30-10-84	GJL1311901R8104	5	0.355
						0 1	VB7-30-01-84	GJL1311901R8014	5	0.355
				220 ... 240	220 ... 240	1 0	VB7-30-10-80	GJL1311901R8100	5	0.355
						0 1	VB7-30-01-80	GJL1311901R8010	5	0.355
				380 ... 415	380 ... 415	1 0	VB7-30-10-85	GJL1311901R8105	5	0.355
						0 1	VB7-30-01-85	GJL1311901R8015	5	0.355

Other types on request

Main dimensions mm, inches

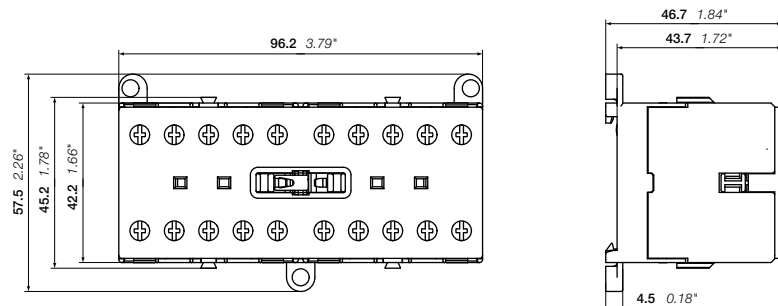

VB6, VB7

2CDC211006F0011

2CDC102016C0201

VBC6, VBC7 3-pole mini reversing contactors – with screw terminals

4 to 5.5 kW

DC operated



VBC6-30-10

2CDC211042F0011



VBC7-30-10

2CDC211001F0011

Description

VBC6, VBC7 3-pole compact design reversing contactors are space optimized control products mainly used for switching resistive or motor loads up to 690 V AC.

These reversing contactors are designed with:

- built-in mechanical interlock. The coils must be mutually interlocked electrically and coils must be de-energised for 50 ms at least to prevent phase to phase short circuit on the arc.
- control circuit: DC operated, low coil consumption (3.5 W at pull-in and at holding)
- hum-free coil
- add-on auxiliary contact blocks for front mounting
- designed for rail or wall mounting

Ordering details

IEC Rated operational power	UL/CSA 3-phase motor rating 480 V	General use rating 600 V AC	Rated control circuit voltage: U _c	Auxiliary contacts fitted	Type	Order code	Pkg qty	Weight (1 pce)
400 V AC-3 kW	AC-1 A	hp	A	V DC				kg

VBC6 mini reversing contactors

Rated power (kW)	UL/CSA 3-phase motor rating (hp)	General use rating (A)	Rated control circuit voltage (V DC)	Auxiliary contacts fitted	Type	Order code	Pkg qty	Weight (1 pce) (kg)	
4	16	3	3.4	12	0	VBC6-30-10-07	GJL1213901R0107	5	0.355
					1	VBC6-30-01-07	GJL1213901R0017	5	0.355
				24	0	VBC6-30-10-01	GJL1213901R0101	5	0.355
					1	VBC6-30-01-01	GJL1213901R0011	5	0.355
				48	0	VBC6-30-10-16	GJL1213901R1106	5	0.355
					1	VBC6-30-01-16	GJL1213901R1016	5	0.355
				60	0	VBC6-30-10-03	GJL1213901R0103	5	0.355
					1	VBC6-30-01-03	GJL1213901R0013	5	0.355
				110 ... 125	0	VBC6-30-10-04	GJL1213901R0104	5	0.355
					1	VBC6-30-01-04	GJL1213901R0014	5	0.355
				220 ... 240	0	VBC6-30-10-05	GJL1213901R0105	5	0.355
					1	VBC6-30-01-05	GJL1213901R0015	5	0.355

VBC7 mini reversing contactors

Rated power (kW)	UL/CSA 3-phase motor rating (hp)	General use rating (A)	Rated control circuit voltage (V DC)	Auxiliary contacts fitted	Type	Order code	Pkg qty	Weight (1 pce) (kg)	
5.5	20	5	7.6	12	0	VBC7-30-10-07	GJL1313901R0107	5	0.355
					1	VBC7-30-01-07	GJL1313901R0017	5	0.355
				24	0	VBC7-30-10-01	GJL1313901R0101	5	0.355
					1	VBC7-30-01-01	GJL1313901R0011	5	0.355
				48	0	VBC7-30-10-16	GJL1313901R1106	5	0.355
					1	VBC7-30-01-16	GJL1313901R1016	5	0.355
				60	0	VBC7-30-10-03	GJL1313901R0103	5	0.355
					1	VBC7-30-01-03	GJL1313901R0013	5	0.355
				110 ... 125	0	VBC7-30-10-04	GJL1313901R0104	5	0.355
					1	VBC7-30-01-04	GJL1313901R0014	5	0.355
				220 ... 240	0	VBC7-30-10-05	GJL1313901R0105	5	0.355
					1	VBC7-30-01-05	GJL1313901R0015	5	0.355

Other types on request

Main dimensions mm, inches

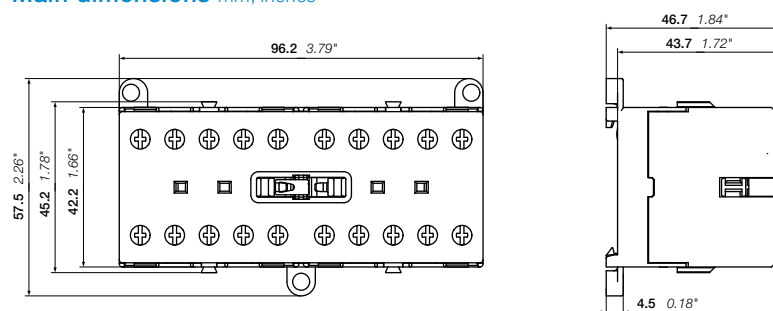

VBC6, VBC7

2CDC212005F0011

2CDC102017C0201

BC6, BC7 3-pole interface mini contactors – with screw terminals

4 to 5.5 kW

DC operated



BC6-30-10

2CDC211040F0011

3



BC7-30-10

2CDC211013F0011

Description

BC6, BC7 3-pole interface mini contactors are compact control products mainly used for switching resistive or motor loads up to 690 V AC.

These contactors are designed with:

- 3 main poles and one built-in auxiliary contact
- control circuit: DC operated, very low coil consumption. Suitable for direct control by PLC outputs
- hum-free coil
- no auxiliary contact block permitted for mounting
- designed for rail or wall mounting

Ordering details

IEC		UL/CSA		Rated control circuit voltage U_c	Auxiliary contacts fitted	Type	Order code	Pkg qty	Weight (1 pce)
Rated operational power	current $\theta \leq 55^\circ\text{C}$	3-phase motor rating	General use rating						
400 V AC-3 kW	AC-1 A	480 V hp	600 V AC A	V DC					kg

DC operation 24 V / 1.4 W

Rated operational power	current	3-phase motor rating	General use rating	Rated control circuit voltage U_c	Auxiliary contacts fitted	Type	Order code	Pkg qty	Weight (1 pce)
4	16	3	3.4	24	1 0	BC6-30-10-1.4-81	GJL1213001R8101	10	0.175
					0 1	BC6-30-01-1.4-81	GJL1213001R8011	10	0.175
5.5	20	5	7.6	24	1 0	BC7-30-10-1.4-81	GJL1313001R8101	10	0.175
					0 1	BC7-30-01-1.4-81	GJL1313001R8011	10	0.175

DC operation 17 ... 32 V / 2.4 W

Rated operational power	current	3-phase motor rating	General use rating	Rated control circuit voltage U_c	Auxiliary contacts fitted	Type	Order code	Pkg qty	Weight (1 pce)
4	16	3	3.4	17 ... 32 (1)	1 0	BC6-30-10-2.4-51	GJL1213001R5101	10	0.175
					0 1	BC6-30-01-2.4-51	GJL1213001R5011	10	0.175
5.5	20	5	7.6	17 ... 32 (1)	1 0	BC7-30-10-2.4-51	GJL1313001R5101	10	0.175
					0 1	BC7-30-01-2.4-51	GJL1313001R5011	10	0.175

Connection to PLCs with integrated protective circuit

DC operation 24 V / 1.7 W

Rated operational power	current	3-phase motor rating	General use rating	Rated control circuit voltage U_c	Auxiliary contacts fitted	Type	Order code	Pkg qty	Weight (1 pce)
4	16	3	3.4	24	1 0	B6S-30-10-1.7-71	GJL1213001R7101	10	0.175
					0 1	B6S-30-01-1.7-71	GJL1213001R7011	10	0.175
5.5	20	5	7.6	24	1 0	B7S-30-10-1.7-71	GJL1313001R7101	10	0.175
					0 1	B7S-30-01-1.7-71	GJL1313001R7011	10	0.175

DC operation 17 ... 32 V / 2.8 W

Rated operational power	current	3-phase motor rating	General use rating	Rated control circuit voltage U_c	Auxiliary contacts fitted	Type	Order code	Pkg qty	Weight (1 pce)
4	16	3	3.4	17 ... 32 (1)	1 0	B6S-30-10-2.8-72	GJL1213001R7102	10	0.175
					0 1	B6S-30-01-2.8-72	GJL1213001R7012	10	0.175
5.5	20	5	7.6	17 ... 32 (1)	1 0	B7S-30-10-2.8-72	GJL1313001R7102	10	0.175
					0 1	B7S-30-01-2.8-72	GJL1313001R7012	10	0.175

Other types on request

(1) U_c min. and U_c max. limit values, including the voltage variation tolerances (-15 % and +10 %).

Main dimensions mm, inches

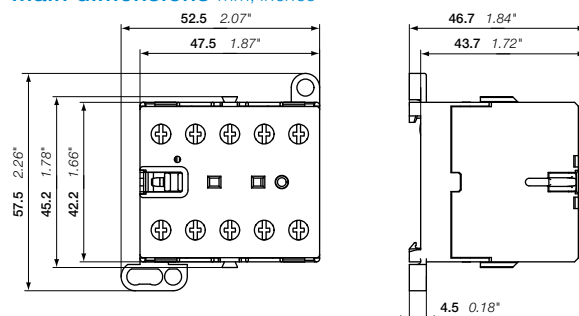

BC6, BC7

2CDC212010F0011

2CDC102010C0201

TBC7 3-pole mini contactors – with screw terminals

4 to 5.5 kW

DC operated – large coil voltage range



TBC7-30-10

Description

TBC7 3-pole mini contactors are compact control products mainly used for switching resistive or motor loads up to 690 V AC.

These contactors are designed with:

- 3 main poles and one built-in auxiliary contact
- control circuit: DC operated, low coil consumption (5 W at pull-in and at holding)
- hum-free coil
- expanded ambient temperature range -30 ... +70 °C and wide range voltage supply
- no auxiliary contact block permitted for mounting
- designed for rail or wall mounting
- material is approved for railway applications

Ordering details

IEC	UL/CSA	Rated control circuit voltage	Auxiliary contacts fitted	Type	Order code	Pkg qty	Weight (1 pce)
Rated operational power 400 V AC-3 kW	3-phase motor rating 480 V hp General use rating 600 V AC A	$U_{Cmin} \dots U_{Cmax}$ (1) V DC	$\begin{matrix} \\ \diagdown \\ \\ \diagup \\ \end{matrix}$				kg

TBC7 mini contactors

Rated power (kW)	Rated current (A)	3-phase motor rating (hp)	General use rating (A)	Rated control circuit voltage (V DC)	Auxiliary contacts fitted	Type	Order code	Pkg qty	Weight (1 pce)
5.5	20	5	7.6	17 ... 32	1 0	TBC7-30-10-51	GJL1313061R5101	10	0.185
					0 1	TBC7-30-01-51	GJL1313061R5011	10	0.185
					1 0	TBC7-30-10-55	GJL1313061R5105	10	0.185
					0 1	TBC7-30-01-55	GJL1313061R5015	10	0.185
					1 0	TBC7-30-10-62	GJL1313061R6102	10	0.185
					0 1	TBC7-30-01-62	GJL1313061R6012	10	0.185
					1 0	TBC7-30-10-68	GJL1313061R6108	10	0.185
					0 1	TBC7-30-01-68	GJL1313061R6018	10	0.185

Other types on request

(1) U_c min. and U_c max. limit values, including the voltage variation tolerances (-15 % and +10 %).

Main dimensions mm, inches

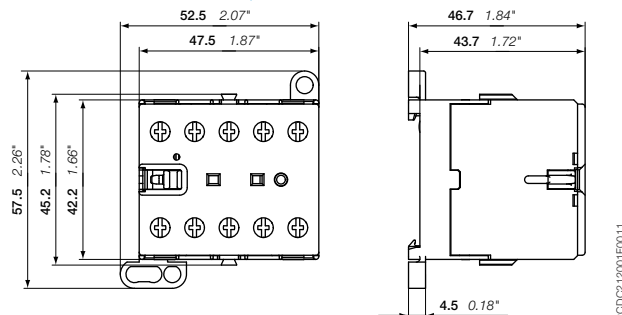

TBC7

B6, B7 4-pole mini contactors – with screw terminals

4 to 5.5 kW

AC operated



B6-22-00

3

Description

B6, B7 4-pole mini contactors are compact control products mainly used for switching resistive loads up to 690 V AC.

These contactors are designed with:

- 4 main poles
- control circuit: AC operated, low coil consumption (3.5 VA at pull-in and at holding)
- add-on auxiliary contact blocks for front or side mounting and a wide range of accessories
- hum-free coil
- designed for rail or wall mounting

Ordering details

IEC	UL/CSA	Rated control circuit voltage U_c	Auxiliary contacts fitted	Type	Order code	Pkg qty	Weight (1 pce)
Rated operational current $\theta \leq 55^\circ\text{C}$ AC-1	General use rating 600 V AC	50/60 HZ					kg
A	A	V AC					

4 N.O. main poles

16	8.4	24	0 0	B6-40-00-01	GJL1211201R0001	10	0.175
		42	0 0	B6-40-00-02	GJL1211201R0002	10	0.175
		48	0 0	B6-40-00-03	GJL1211201R0003	10	0.175
		110 ... 127	0 0	B6-40-00-84	GJL1211201R8004	10	0.175
		220 ... 240	0 0	B6-40-00-80	GJL1211201R8000	10	0.175
20	13.8	24	0 0	B7-40-00-01	GJL1311201R0001	10	0.175
		42	0 0	B7-40-00-02	GJL1311201R0002	10	0.175
		48	0 0	B7-40-00-03	GJL1311201R0003	10	0.175
		110 ... 127	0 0	B7-40-00-84	GJL1311201R8004	10	0.175
		220 ... 240	0 0	B7-40-00-80	GJL1311201R8000	10	0.175

2 N.O. + 2 N.C. main poles

16	8.4	24	0 0	B6-22-00-01	GJL1211501R0001	10	0.175
		42	0 0	B6-22-00-02	GJL1211501R0002	10	0.175
		48	0 0	B6-22-00-03	GJL1211501R0003	10	0.175
		110 ... 127	0 0	B6-22-00-84	GJL1211501R8004	10	0.175
		220 ... 240	0 0	B6-22-00-80	GJL1211501R8000	10	0.175
20	13.8	24	0 0	B7-22-00-01	GJL1311501R0001	10	0.175
		42	0 0	B7-22-00-02	GJL1311501R0002	10	0.175
		48	0 0	B7-22-00-03	GJL1311501R0003	10	0.175
		110 ... 127	0 0	B7-22-00-84	GJL1311501R8004	10	0.175
		220 ... 240	0 0	B7-22-00-80	GJL1311501R8000	10	0.175

Other types on request

Main dimensions mm, inches

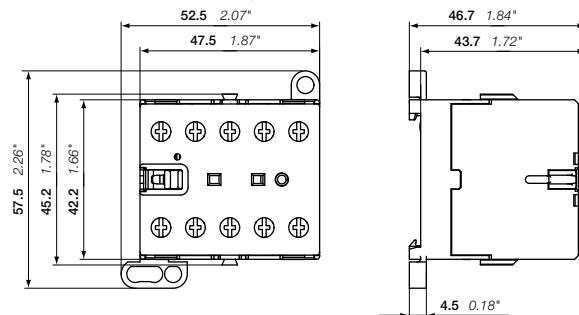

B6, B7

BC6, B7D 4-pole mini contactors – with screw terminals

4 to 5.5 kW

DC operated



BC6-22-00

Description

BC6, B7D 4-pole mini contactors are compact control products mainly used for switching resistive loads up to 690 V AC.

These contactors are designed with:

- 4 main poles
- control circuit: DC operated, low coil consumption (3.5 W at pull-in and at holding)
- hum-free coil
- add-on auxiliary contact blocks for front or side mounting
- designed for rail or wall mounting

Ordering details

IEC	UL/CSA	Rated control circuit voltage: U_c	Auxiliary contacts fitted	Type	Order code	Pkg qty	Weight (1 pce)
Rated operational current $\theta \leq 55^\circ\text{C}$ AC-1	General use rating 600 V AC	V DC					kg
A	A						

4 N.O. main poles

20	13.8	24	0 0	B7D-40-00-01	GJL1317201R0001	10	0.175
		220	0 0	B7D-40-00-05	GJL1317201R0005	10	0.175

2 N.O. + 2 N.C. main poles

16	8.4	12	0 0	BC6-22-00-07	GJL1213501R0007	10	0.175
		24	0 0	BC6-22-00-01	GJL1213501R0001	10	0.175
		42	0 0	BC6-22-00-02	GJL1213501R0002	10	0.175
		48	0 0	BC6-22-00-16	GJL1213501R1006	10	0.175
		60	0 0	BC6-22-00-03	GJL1213501R0003	10	0.175
		110 ... 125	0 0	BC6-22-00-04	GJL1213501R0004	10	0.175
220 ... 240	0 0	BC6-22-00-05	GJL1213501R0005	10	0.175		

Other types on request

Main dimensions mm, inches

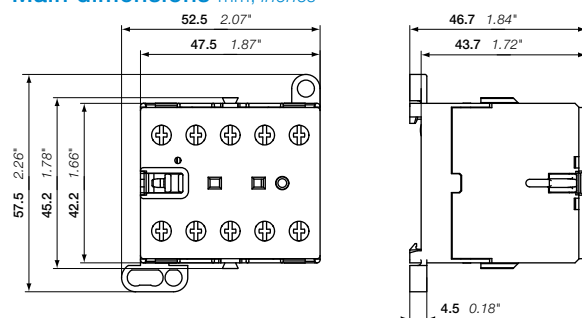

BC6, B7D

TBC7 4-pole mini contactors – with screw terminals

4 to 5.5 kW

DC operated – large coil voltage range



TBC7-31-00

3

Description

TBC7 4-pole mini contactors are compact control products mainly used for switching resistive or motor loads up to 690 V AC.

These contactors are designed with:

- 4 main poles
- control circuit: DC operated, low coil consumption (5 W at pull-in and at holding)
- hum-free coil
- expanded ambient temperature range -30 ... +70 °C and wide range voltage supply
- no auxiliary contact block permitted for mounting
- designed for rail or wall mounting
- material is approved for railway applications

Ordering details

IEC	UL/CSA	Rated control circuit voltage $U_{C \text{ min}} \dots U_{C \text{ max}}$ (1)	Auxiliary contacts fitted	Type	Order code	Pkg qty	Weight (1 pce)
Rated operational current $\theta \leq 55 \text{ °C}$ AC-1	General use rating 600 V AC	V DC					kg
3 N.O. + 1 N.C. main poles							
5.5	20	50 ... 90	0 0	TBC7-31-00-55	GJL1313461R5005	10	0.185
		77 ... 143	0 0	TBC7-31-00-62	GJL1313461R6002	10	0.185
		140 ... 260	0 0	TBC7-31-00-68	GJL1313461R6008	10	0.185
2 N.O. + 2 N.C. main poles							
5.5	20	50 ... 90	0 0	TBC7-22-00-55	GJL1313561R5005	10	0.185
		77 ... 143	0 0	TBC7-22-00-62	GJL1313561R6002	10	0.185
		140 ... 260	0 0	TBC7-22-00-68	GJL1313561R6008	10	0.185

Other types on request

(1) $U_{C \text{ min}}$ and $U_{C \text{ max}}$ limit values, including the voltage variation tolerances (-15 % and +10 %).

Main dimensions mm, inches

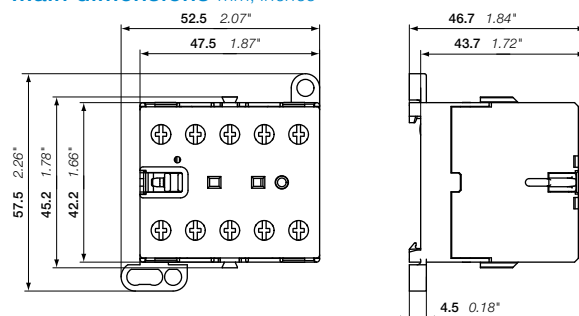

TBC7

Notes

A series of horizontal dotted lines for taking notes.

K6 4-pole mini contactor relays – with screw terminals AC operated



K6-22Z

2CDC211012F0011



K6-31Z

2CDC211004F0010

3

Description

K6 4-pole mini contactor relays are space optimized control products mainly used for control functions or for small loads up to 4 A.

These contactors are designed with:

- 4 poles with various contact combinations
- control circuit: AC operated, low coil consumption (3.5 VA at pull-in and at holding)
- hum-free coil
- add-on auxiliary contact blocks for front or side mounting
- designed for rail or wall mounting

Ordering details

Rated control circuit voltage U _c	Auxiliary contacts fitted	Type	Order code	Pkg qty	Weight (1 pce)
50 Hz V AC					kg
60 Hz V AC					

K6 4-pole mini contactor relays

Rated current I _N	Rated voltage U _N	Rated power P _N	Rated current I _N	Rated voltage U _N	Rated power P _N	Order code	Pkg qty	Weight (1 pce)
24	24	2	2	K6-22Z-01	GJH1211001R0221	10	0.175	
42	42	2	2	K6-22Z-02	GJH1211001R0222	10	0.175	
48	48	2	2	K6-22Z-03	GJH1211001R0223	10	0.175	
110 ... 127	110 ... 127	2	2	K6-22Z-84	GJH1211001R8224	10	0.175	
220 ... 240	220 ... 240	2	2	K6-22Z-80	GJH1211001R8220	10	0.175	
380 ... 415	380 ... 415	2	2	K6-22Z-85	GJH1211001R8225	10	0.175	
24	24	3	1	K6-31Z-01	GJH1211001R0311	10	0.175	
42	42	3	1	K6-31Z-02	GJH1211001R0312	10	0.175	
48	48	3	1	K6-31Z-03	GJH1211001R0313	10	0.175	
110 ... 127	110 ... 127	3	1	K6-31Z-84	GJH1211001R8314	10	0.175	
220 ... 240	220 ... 240	3	1	K6-31Z-80	GJH1211001R8310	10	0.175	
380 ... 415	380 ... 415	3	1	K6-31Z-85	GJH1211001R8315	10	0.175	
24	24	4	0	K6-40E-01	GJH1211001R0401	10	0.175	
42	42	4	0	K6-40E-02	GJH1211001R0402	10	0.175	
48	48	4	0	K6-40E-03	GJH1211001R0403	10	0.175	
110 ... 127	110 ... 127	4	0	K6-40E-84	GJH1211001R8404	10	0.175	
220 ... 240	220 ... 240	4	0	K6-40E-80	GJH1211001R8400	10	0.175	
380 ... 415	380 ... 415	4	0	K6-40E-85	GJH1211001R8405	10	0.175	

Other types on request

Main dimensions mm, inches

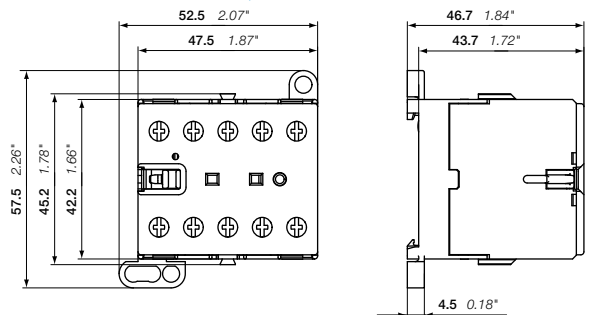

K6

2CDC212001F0011

2CDC102011C0201

KC6 4-pole mini contactor relays – with screw terminals DC operated



KC6-22Z

2CDC21101R0011

Description

KC6 4-pole mini contactor relays are space optimized control products mainly used for control functions or for small loads up to 4 A.

These contactors are designed with:

- 4 poles with various contact combinations
- control circuit: DC operated, low coil consumption (3.5 W at pull-in and at holding)
- hum-free coil
- add-on auxiliary contact blocks for front or side mounting
- designed for rail or wall mounting

Ordering details

Rated control circuit voltage U_c	Auxiliary contacts fitted	Type	Order code	Pkg qty	Weight (1 pce)
V DC					kg

KC6 4-pole mini contactor relays

12	2 2	KC6-22Z-07	GJH1213001R0227	10	0.175
24	2 2	KC6-22Z-01	GJH1213001R0221	10	0.175
48	2 2	KC6-22Z-16	GJH1213001R1226	10	0.175
60	2 2	KC6-22Z-13	GJH1213001R1223	10	0.175
110 ... 125	2 2	KC6-22Z-04	GJH1213001R0224	10	0.175
220 ... 240	2 2	KC6-22Z-05	GJH1213001R0225	10	0.175
12	3 1	KC6-31Z-07	GJH1213001R0317	10	0.175
24	3 1	KC6-31Z-01	GJH1213001R0311	10	0.175
48	3 1	KC6-31Z-16	GJH1213001R1316	10	0.175
60	3 1	KC6-31Z-13	GJH1213001R1313	10	0.175
110 ... 125	3 1	KC6-31Z-04	GJH1213001R0314	10	0.175
220 ... 240	3 1	KC6-31Z-05	GJH1213001R0315	10	0.175
12	4 0	KC6-40E-07	GJH1213001R0407	10	0.175
24	4 0	KC6-40E-01	GJH1213001R0401	10	0.175
48	4 0	KC6-40E-16	GJH1213001R1406	10	0.175
60	4 0	KC6-40E-13	GJH1213001R1403	10	0.175
110 ... 125	4 0	KC6-40E-04	GJH1213001R0404	10	0.175
220 ... 240	4 0	KC6-40E-05	GJH1213001R0405	10	0.175

Other types on request

Main dimensions mm, inches

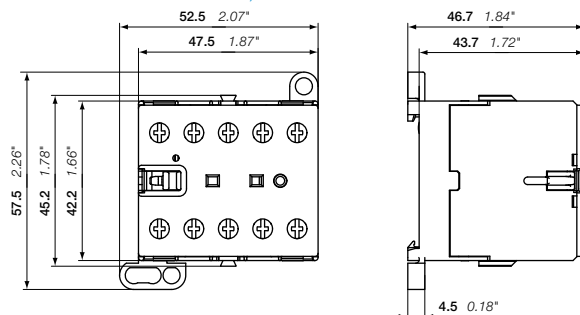

KC6

2CDC212001R0011

2CDC102012C0201

KC6 4-pole interface mini contactor relays – with screw terminals DC operated



KC6-31Z

3

Description

KC6 4-pole interface mini contactor relays are space optimized control products mainly used for control functions or for small loads up to 4 A.

These contactors are designed with:

- 4 poles with various contact combinations
- control circuit: DC operated, low coil consumption (1.4 ... 2.8 W at pull-in and at holding)
- hum-free coil
- no auxiliary contact block permitted for mounting
- designed for rail or wall mounting

Ordering details

Rated control circuit voltage U_c	Auxiliary contacts fitted	Type	Order code	Pkg qty	Weight (1 pce)
V DC					kg
DC operation 24 V / 1.4 W					
24	3 1	KC6-31Z-1.4-81	GJH1213001R8311	10	0.175
24	4 0	KC6-40E-1.4-81	GJH1213001R8401	10	0.175
DC operation 17 ... 32 V / 2.4 W					
17 ... 32 (1)	3 1	KC6-31Z-2.4-51	GJH1213001R5311	10	0.175
17 ... 32 (1)	4 0	KC6-40E-2.4-51	GJH1213001R5401	10	0.175
DC operation 24 V / 1.7 W					
24	2 2	K6S-22Z-1.7-71	GJH1213001R7221	10	0.175
24	3 1	K6S-31Z-1.7-71	GJH1213001R7311	10	0.175
24	4 0	K6S-40E-1.7-71	GJH1213001R7401	10	0.175
DC operation 17 ... 32 V / 2.8 W					
17 ... 32 (1)	2 2	K6S-22Z-2.8-72	GJH1213001R7222	10	0.175
17 ... 32 (1)	3 1	K6S-31Z-2.8-72	GJH1213001R7312	10	0.175
17 ... 32 (1)	4 0	K6S-40E-2.8-72	GJH1213001R7402	10	0.175

Other types on request

(1) U_c min. and U_c max. limit values, including the voltage variation tolerances (-15 % and +10 %).

Main dimensions mm, inches

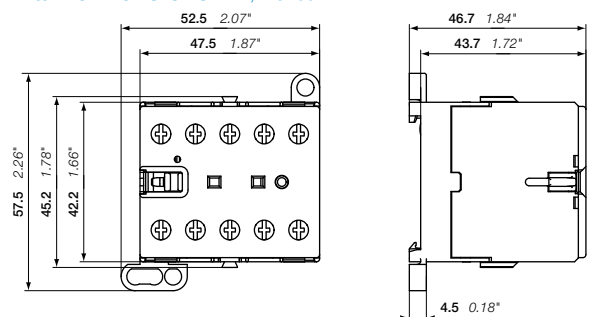

KC6

TKC6 4-pole mini contactor relays – with screw terminals

DC operated – large coil voltage range



TKC6-31Z

2CDC21021F0011

Description

TKC6 4-pole mini contactors are space optimized control products mainly used for control functions or for small loads up to 4 A.

These contactors are designed with:

- 4 poles with various contact combinations
- control circuit: DC operated, hum free, low consumption (5 W at pull-in and at holding)
- expanded ambient temperature range -30 ... +70 °C and wide range voltage supply
- material is suitable for railway applications
- humfree operating DC coil
- no auxiliary contact block permitted for mounting
- designed for rail or wall mounting

Ordering details

Rated control circuit voltage $U_{Cmin} \dots U_{Cmax}$ (1)	Auxiliary contacts fitted	Type	Order code	Pkg qty	Weight (1 pce)
VDC					kg
17 ... 32	2 2	TKC6-22Z-51	GJH1213061R5221	10	0.180
50 ... 90	2 2	TKC6-22Z-55	GJH1213061R5225	10	0.180
77 ... 143	2 2	TKC6-22Z-62	GJH1213061R6222	10	0.180
140 ... 260	2 2	TKC6-22Z-68	GJH1213061R6228	10	0.180
17 ... 32	3 1	TKC6-31Z-51	GJH1213061R5311	10	0.180
50 ... 90	3 1	TKC6-31Z-55	GJH1213061R5315	10	0.180
77 ... 143	3 1	TKC6-31Z-62	GJH1213061R6312	10	0.180
140 ... 260	3 1	TKC6-31Z-68	GJH1213061R6318	10	0.180
17 ... 32	4 0	TKC6-40E-51	GJH1213061R5401	10	0.180
50 ... 90	4 0	TKC6-40E-55	GJH1213061R5405	10	0.180
77 ... 143	4 0	TKC6-40E-62	GJH1213061R6402	10	0.180
140 ... 260	4 0	TKC6-40E-68	GJH1213061R6408	10	0.180

Other types on request

(1) U_{Cmin} and U_{Cmax} limit values, including the voltage variation tolerances (-15 % and +10 %).

Main dimensions mm, inches

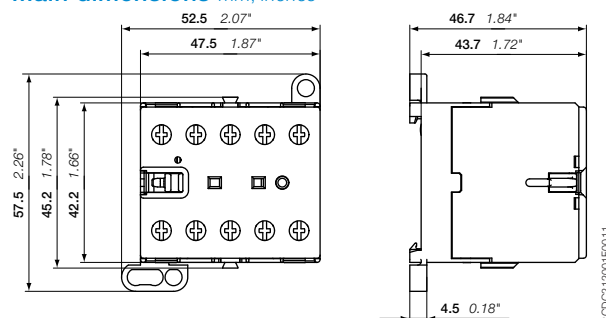

TKC6

2CDC210201F0011

2CDC102014C0201

B6, B7 3-pole mini contactors – with soldering pins

4 to 5.5 kW

AC operated



B6-30-10-P

2CDC211003F0010

3



B7-30-10-P

2CDC211011F0011

Description

B6..P and B7..P 3-pole mini contactors are compact control products mainly used for switching resistive or motor loads up to 690 V AC.

These contactors are designed with:

- 3 main poles and one built-in auxiliary contact
- control circuit: AC operated, low coil consumption (3.5 VA at pull-in and at holding)
- hum-free coil
- add-on auxiliary contact blocks for side mounting
- designed for soldering on PCB boards

Ordering details

IEC		UL/CSA		Rated control circuit voltage U _c		Auxiliary contacts fitted	Type	Order code	Pkg qty	Weight (1 pce)
Rated operational power	current θ ≤ 55 °C	3-phase motor rating	General use rating	50 Hz	60 Hz					
400 V AC-3	AC-1	480 V	600 V AC	V AC	V AC					kg
kW	A	hp	A							

B6 mini contactors

4	12	3	3.4	24	24	1 0	B6-30-10-P-01	GJL1211009R0101	10	0.170
						0 1	B6-30-01-P-01	GJL1211009R0011	10	0.170
				42	42	1 0	B6-30-10-P-02	GJL1211009R0102	10	0.170
						0 1	B6-30-01-P-02	GJL1211009R0012	10	0.170
				48	48	1 0	B6-30-10-P-03	GJL1211009R0103	10	0.170
						0 1	B6-30-01-P-03	GJL1211009R0013	10	0.170
				110 ... 127	110 ... 127	1 0	B6-30-10-P-84	GJL1211009R8104	10	0.170
						0 1	B6-30-01-P-84	GJL1211009R8014	10	0.170
				220 ... 240	220 ... 240	1 0	B6-30-10-P-80	GJL1211009R8100	10	0.170
						0 1	B6-30-01-P-80	GJL1211009R8010	10	0.170
				380 ... 415	380 ... 415	1 0	B6-30-10-P-85	GJL1211009R8105	10	0.170
						0 1	B6-30-01-P-85	GJL1211009R8015	10	0.170

B7 mini contactors

5.5	12	5	7.6	24	24	1 0	B7-30-10-P-01	GJL1311009R0101	10	0.170
						0 1	B7-30-01-P-01 <td>GJL1311009R0011 <td>10</td> <td>0.170</td> </td>	GJL1311009R0011 <td>10</td> <td>0.170</td>	10	0.170
				42	42	1 0	B7-30-10-P-02 <td>GJL1311009R0102 <td>10</td> <td>0.170</td> </td>	GJL1311009R0102 <td>10</td> <td>0.170</td>	10	0.170
						0 1	B7-30-01-P-02 <td>GJL1311009R0012 <td>10</td> <td>0.170</td> </td>	GJL1311009R0012 <td>10</td> <td>0.170</td>	10	0.170
				48	48	1 0	B7-30-10-P-03 <td>GJL1311009R0103 <td>10</td> <td>0.170</td> </td>	GJL1311009R0103 <td>10</td> <td>0.170</td>	10	0.170
						0 1	B7-30-01-P-03 <td>GJL1311009R0013 <td>10</td> <td>0.170</td> </td>	GJL1311009R0013 <td>10</td> <td>0.170</td>	10	0.170
				110 ... 127	110 ... 127	1 0	B7-30-10-P-84 <td>GJL1311009R8104 <td>10</td> <td>0.170</td> </td>	GJL1311009R8104 <td>10</td> <td>0.170</td>	10	0.170
						0 1	B7-30-01-P-84 <td>GJL1311009R8014 <td>10</td> <td>0.170</td> </td>	GJL1311009R8014 <td>10</td> <td>0.170</td>	10	0.170
				220 ... 240	220 ... 240	1 0	B7-30-10-P-80 <td>GJL1311009R8100 <td>10</td> <td>0.170</td> </td>	GJL1311009R8100 <td>10</td> <td>0.170</td>	10	0.170
						0 1	B7-30-01-P-80 <td>GJL1311009R8010 <td>10</td> <td>0.170</td> </td>	GJL1311009R8010 <td>10</td> <td>0.170</td>	10	0.170
				380 ... 415	380 ... 415	1 0	B7-30-10-P-85 <td>GJL1311009R8105 <td>10</td> <td>0.170</td> </td>	GJL1311009R8105 <td>10</td> <td>0.170</td>	10	0.170
						0 1	B7-30-01-P-85 <td>GJL1311009R8015 <td>10</td> <td>0.170</td> </td>	GJL1311009R8015 <td>10</td> <td>0.170</td>	10	0.170

Other types on request

Main dimensions mm, inches

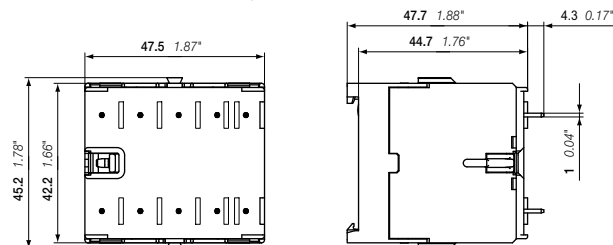

B6, B7

2CDC212003F0011

2CDC102023C0201

BC6, BC7 3-pole mini contactors – with soldering pins

4 to 5.5 kW

DC operated



BC7-30-10-P

2CDC211030R0011

Description

BC6, BC7 3-pole mini contactors are compact control products mainly used for switching resistive or motor loads up to 690 V AC.

These contactors are designed with:

- 3 main poles and one built-in auxiliary contact
- control circuit: DC operated, low coil consumption (3.5 W at pull-in and at holding)
- hum-free coil
- add-on auxiliary contact blocks for side mounting
- designed for soldering on PCB boards

Ordering details

IEC		UL/CSA		Rated control circuit voltage: U_c	Auxiliary contacts fitted	Type	Order code	Pkg qty	Weight (1 pce)
Rated power	operational current $\theta \leq 55^\circ\text{C}$	3-phase motor rating	General use rating						
400 V AC-3 kW	AC-1 A	480 V hp	600 V AC A	V DC					kg

BC6 mini contactors with 3 N.O. main poles

Rated power	operational current	3-phase motor rating	General use rating	Rated control circuit voltage	Auxiliary contacts	Type	Order code	Pkg qty	Weight	
4	12	3	3.4	12	1 0	BC6-30-10-P-07	GJL1213009R0107	10	0.170	
					0 1	BC6-30-01-P-07	GJL1213009R0017	10	0.170	
					24	1 0	BC6-30-10-P-01	GJL1213009R0101	10	0.170
						0 1	BC6-30-01-P-01	GJL1213009R0011	10	0.170
					48	1 0	BC6-30-10-P-16	GJL1213009R1106	10	0.170
						0 1	BC6-30-01-P-16	GJL1213009R1016	10	0.170
					60	1 0	BC6-30-10-P-03	GJL1213009R0103	10	0.170
						0 1	BC6-30-01-P-03	GJL1213009R0013	10	0.170
					110 ... 125	1 0	BC6-30-10-P-04	GJL1213009R0104	10	0.170
						0 1	BC6-30-01-P-04	GJL1213009R0014	10	0.170
					220 ... 240	1 0	BC6-30-10-P-05	GJL1213009R0105	10	0.170
						0 1	BC6-30-01-P-05	GJL1213009R0015	10	0.170

BC7 mini contactors with 3 N.O. main poles

Rated power	operational current	3-phase motor rating	General use rating	Rated control circuit voltage	Auxiliary contacts	Type	Order code	Pkg qty	Weight	
5.5	12	5	7.6	12	1 0	BC7-30-10-P-07	GJL1313009R0107	10	0.170	
					0 1	BC7-30-01-P-07	GJL1313009R0017	10	0.170	
					24	1 0	BC7-30-10-P-01	GJL1313009R0101	10	0.170
						0 1	BC7-30-01-P-01	GJL1313009R0011	10	0.170
					48	1 0	BC7-30-10-P-16	GJL1313009R1106	10	0.170
						0 1	BC7-30-01-P-16	GJL1313009R1016	10	0.170
					60	1 0	BC7-30-10-P-03	GJL1313009R0103	10	0.170
						0 1	BC7-30-01-P-03	GJL1313009R0013	10	0.170
					110 ... 125	1 0	BC7-30-10-P-04	GJL1313009R0104	10	0.170
						0 1	BC7-30-01-P-04	GJL1313009R0014	10	0.170
					220 ... 240	1 0	BC7-30-10-P-05	GJL1313009R0105	10	0.170
						0 1	BC7-30-01-P-05	GJL1313009R0015	10	0.170

BC6 mini contactors 2 N.O. + 1 N.C. main poles

Rated power	operational current	3-phase motor rating	General use rating	Rated control circuit voltage	Auxiliary contacts	Type	Order code	Pkg qty	Weight
4	12	3	3.4	24	1 0	BC6-21-10-P-01	GJL1213109R0101	10	0.170
					1 0	BC6-21-10-P-16	GJL1213109R1106	10	0.170
					1 0	BC6-21-10-P-03	GJL1213109R0103	10	0.170
					1 0	BC6-21-10-P-04	GJL1213109R0104	10	0.170
					1 0	BC6-21-10-P-05	GJL1213109R0105	10	0.170

Other types on request

Main dimensions mm, inches

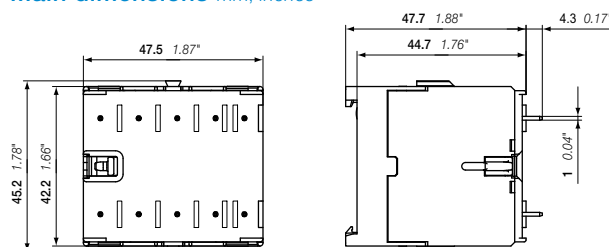

B6, B7

2CDC212030R0011

2CDC102024C0201

VB6, VB7 3-pole mini reversing contactors – with soldering pins

4 to 5.5 kW

AC operated

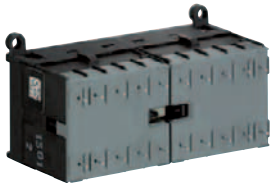

2CDC211010S0011

VB7-30-10-P

3

Description

VB6, VB7 3-pole compact design reversing contactors are space optimized control products mainly used for switching resistive or motor loads up to 690 V AC.

These reversing contactors are designed with:

- built-in mechanical interlock. The coils must be mutually interlocked electrically and coils must be de-energised for 50 ms at least to prevent phase to phase short circuit on the arc
- control circuit: AC operated, low coil consumption (3.5 VA at pull-in and at holding)
- hum-free coil
- no auxiliary contact block permitted for mounting
- designed for soldering on PCB boards

Ordering details

IEC		UL/CSA		Rated control circuit voltage U _c		Auxiliary contacts fitted	Type	Order code	Pkg qty	Weight (1 pce)
Rated power	operational current θ ≤ 55 °C	3-phase motor rating	General use rating	50 Hz	60 Hz					
400 V AC-3 kW	AC-1 A	480 V hp	600 V AC A	V AC	V AC					kg

VB6 mini reversing contactors

Rated power (kW)	operational current (A)	3-phase motor rating (hp)	General use rating (A)	50 Hz (V AC)	60 Hz (V AC)	1 0	0 1	Type	Order code	Pkg qty	Weight (1 pce) (kg)
4	12	3	3.4	24	24	1	0	VB6-30-10-P-01	GJL1211909R0101	5	0.345
						0	1	VB6-30-01-P-01	GJL1211909R0011	5	0.345
				42	42	1	0	VB6-30-10-P-02	GJL1211909R0102	5	0.345
						0	1	VB6-30-01-P-02	GJL1211909R0012	5	0.345
				48	48	1	0	VB6-30-10-P-03	GJL1211909R0103	5	0.345
						0	1	VB6-30-01-P-03	GJL1211909R0013	5	0.345
				110 ... 127	110 ... 127	1	0	VB6-30-10-P-84	GJL1211909R8104	5	0.345
						0	1	VB6-30-01-P-84	GJL1211909R8014	5	0.345
				220 ... 240	220 ... 240	1	0	VB6-30-10-P-80	GJL1211909R8100	5	0.345
						0	1	VB6-30-01-P-80	GJL1211909R8010	5	0.345
				380 ... 415	380 ... 415	1	0	VB6-30-10-P-85	GJL1211909R8105	5	0.345
						0	1	VB6-30-01-P-85	GJL1211909R8015	5	0.345

VB7 mini reversing contactors

Rated power (kW)	operational current (A)	3-phase motor rating (hp)	General use rating (A)	50 Hz (V AC)	60 Hz (V AC)	1 0	0 1	Type	Order code	Pkg qty	Weight (1 pce) (kg)
5.5	12	5	7.6	24	24	1	0	VB7-30-10-P-01	GJL1311909R0101	5	0.345
						0	1	VB7-30-01-P-01	GJL1311909R0011	5	0.345
				42	42	1	0	VB7-30-10-P-02	GJL1311909R0102	5	0.345
						0	1	VB7-30-01-P-02	GJL1311909R0012	5	0.345
				48	48	1	0	VB7-30-10-P-03	GJL1311909R0103	5	0.345
						0	1	VB7-30-01-P-03	GJL1311909R0013	5	0.345
				110 ... 127	110 ... 127	1	0	VB7-30-10-P-84	GJL1311909R8104	5	0.345
						0	1	VB7-30-01-P-84	GJL1311909R8014	5	0.345
				220 ... 240	220 ... 240	1	0	VB7-30-10-P-80	GJL1311909R8100	5	0.345
						0	1	VB7-30-01-P-80	GJL1311909R8010	5	0.345
				380 ... 415	380 ... 415	1	0	VB7-30-10-P-85	GJL1311909R8105	5	0.345
						0	1	VB7-30-01-P-85	GJL1311909R8015	5	0.345

Other types on request

Main dimensions mm, inches

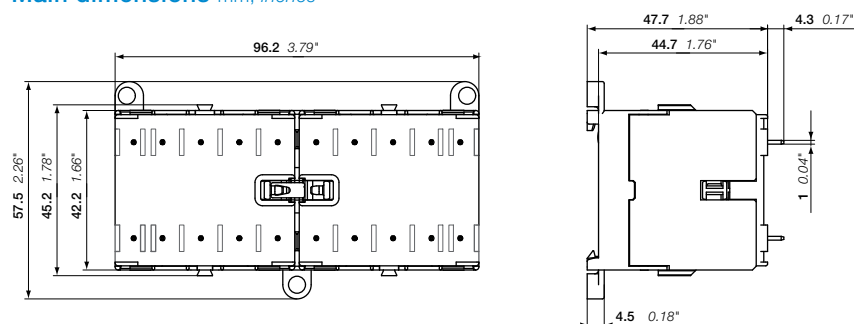

VB6, VB7

2CDC212001F0011

2CDC102025C0201

VBC6, VBC7 3-pole mini reversing contactors – with soldering pins

4 to 5.5 kW

DC operated

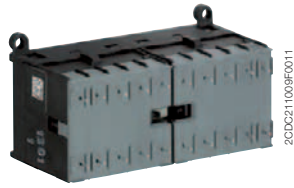

VBC7-30-10-P

2CDC211009F0011

Description

VBC6, VBC7 3-pole compact design reversing contactors are space optimized control products mainly used for switching resistive or motor loads up to 690 V AC.

These reversing contactors are designed with:

- built-in mechanical interlock. The coils must be mutually interlocked electrically and coils must be de-energised for 50 ms at least to prevent phase to phase short circuit on the arc
- control circuit: DC operated, low coil consumption (3.5 W at pull-in and at holding)
- hum-free coil
- no auxiliary contact block permitted for mounting
- designed for soldering on PCB boards

Ordering details

IEC		UL/CSA		Rated control circuit voltage: U_c	Auxiliary contacts fitted	Type	Order code	Pkg qty	Weight (1 pce)
Rated power	operational current $\theta \leq 55^\circ\text{C}$	3-phase motor rating	General use rating						
400 V AC-3 kW	AC-1 A	480 V hp	600 V AC A	V DC					kg

VBC6 mini reversing contactors

Rated power	operational current	3-phase motor rating	General use rating	Rated control circuit voltage	Auxiliary contacts	Type	Order code	Pkg qty	Weight
4	12	3	3.4	12	1 0	VBC6-30-10-P-07	GJL1213909R0107	5	0.345
					0 1	VBC6-30-01-P-07	GJL1213909R0017	5	0.345
				24	1 0	VBC6-30-10-P-01	GJL1213909R0101	5	0.345
					0 1	VBC6-30-01-P-01	GJL1213909R0011	5	0.345
				48	1 0	VBC6-30-10-P-06	GJL1213909R0106	5	0.345
					0 1	VBC6-30-06-P-06	GJL1213909R0016	5	0.345
				60	1 0	VBC6-30-10-P-03	GJL1213909R0103	5	0.345
					0 1	VBC6-30-01-P-03	GJL1213909R0013	5	0.345
				110 ... 125	1 0	VBC6-30-10-P-04	GJL1213909R0104	5	0.345
					0 1	VBC6-30-01-P-04	GJL1213909R0014	5	0.345
					1 0	VBC6-30-10-P-05	GJL1213909R0105	5	0.345
					0 1	VBC6-30-01-P-05	GJL1213909R0015	5	0.345

VBC7 mini reversing contactors

Rated power	operational current	3-phase motor rating	General use rating	Rated control circuit voltage	Auxiliary contacts	Type	Order code	Pkg qty	Weight
5.5	12	5	7.6	12	1 0	VBC7-30-10-P-07	GJL1313909R0107	5	0.345
					0 1	VBC7-30-01-P-07	GJL1313909R0017	5	0.345
				24	1 0	VBC7-30-10-P-01	GJL1313909R0101	5	0.345
					0 1	VBC7-30-01-P-01	GJL1313909R0011	5	0.345
				48	1 0	VBC7-30-10-P-16	GJL1313909R1106	5	0.345
					0 1	VBC7-30-01-P-16	GJL1313909R1016	5	0.345
				60	1 0	VBC7-30-10-P-03	GJL1313909R0103	5	0.345
					0 1	VBC7-30-01-P-03	GJL1313909R0013	5	0.345
				110 ... 125	1 0	VBC7-30-10-P-04	GJL1313909R0104	5	0.345
					0 1	VBC7-30-01-P-04	GJL1313909R0014	5	0.345
					1 0	VBC7-30-10-P-05	GJL1313909R0105	5	0.345
					0 1	VBC7-30-01-P-05	GJL1313909R0015	5	0.345

Other types on request

Main dimensions mm, inches

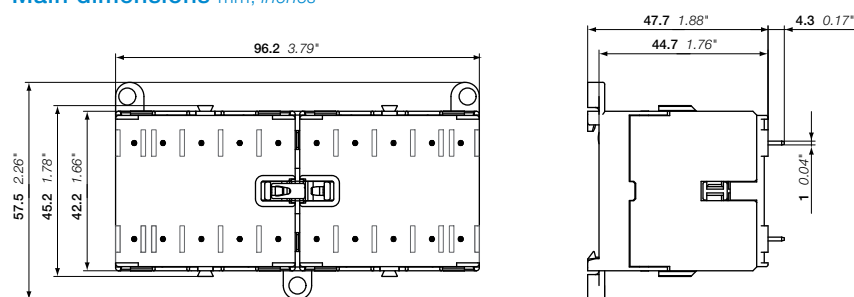

VBC6, VBC7

2CDC212007F0011

2CDC102026C0201

K6 4-pole mini contactor relays – with soldering pins AC operated



2CDC21102ZF0011

K6-22Z-P

3

Description

K6 4-pole mini contactor relays are space optimized control products mainly used for control functions or for small loads up to 4 A.

These contactors are designed with:

- 4 poles with various contact combinations
- control circuit: AC operated, low coil consumption (3.5 VA at pull-in and at holding)
- hum-free coil
- add-on auxiliary contact block for side mounting
- designed for soldering on PCB boards

Ordering details

Rated control circuit voltage U_c		Auxiliary contacts fitted	Type	Order code	Pkg qty	Weight (1 pce)
50 Hz V AC	60 Hz V AC					kg

K6 4-pole mini contactor relays

24	24	2 2	K6-22Z-P-01	GJH1211009R0221	10	0.170
42	42	2 2	K6-22Z-P-02	GJH1211009R0222	10	0.170
48	48	2 2	K6-22Z-P-03	GJH1211009R0223	10	0.170
110 ... 127	110 ... 127	2 2	K6-22Z-P-84	GJH1211009R8224	10	0.170
220 ... 240	220 ... 240	2 2	K6-22Z-P-80	GJH1211009R8220	10	0.170
380 ... 415	380 ... 415	2 2	K6-22Z-P-85	GJH1211009R8225	10	0.170
24	24	3 1	K6-31Z-P-01	GJH1211009R0311	10	0.170
42	42	3 1	K6-31Z-P-02	GJH1211009R0312	10	0.170
48	48	3 1	K6-31Z-P-03	GJH1211009R0313	10	0.170
110 ... 127	110 ... 127	3 1	K6-31Z-P-84	GJH1211009R8314	10	0.170
220 ... 240	220 ... 240	3 1	K6-31Z-P-80	GJH1211009R8310	10	0.170
380 ... 415	380 ... 415	3 1	K6-31Z-P-85	GJH1211009R8315	10	0.170
24	24	4 0	K6-40E-P-01	GJH1211009R0401	10	0.170
42	42	4 0	K6-40E-P-02	GJH1211009R0402	10	0.170
48	48	4 0	K6-40E-P-03	GJH1211009R0403	10	0.170
110 ... 127	110 ... 127	4 0	K6-40E-P-84	GJH1211009R8404	10	0.170
220 ... 240	220 ... 240	4 0	K6-40E-P-80	GJH1211009R8400	10	0.170
380 ... 415	380 ... 415	4 0	K6-40E-P-85	GJH1211009R8405	10	0.170

Other types on request

Main dimensions mm, inches

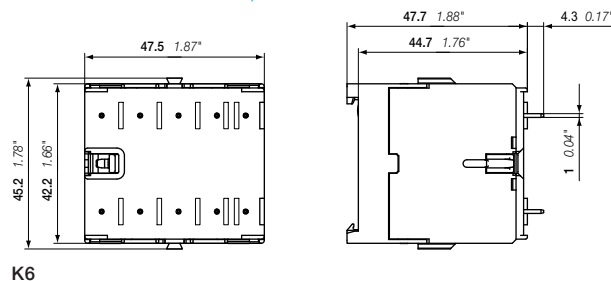

2CDC212003F0011

2CDC102030C0201

KC6 4-pole mini contactor relays – with soldering pins DC operated



KC6-22Z-P

2CDC0211025F0011



KC6-31Z-P

2CDC0211023F0011

Description

KC6 4-pole mini contactor relays are space optimized control products mainly used for control functions or for small loads up to 4 A.

These contactors are designed with:

- 4 poles with various contact combinations
- control circuit: DC operated, low coil consumption (3.5 W at pull-in and at holding)
- hum-free coil
- add-on auxiliary contact block for side mounting
- designed for soldering on PCB boards

Ordering details

Rated control circuit voltage U_c	Auxiliary contacts fitted	Type	Order code	Pkg qty	Weight (1 pce)
VDC					kg

K6 4-pole mini contactor relays

Rated control circuit voltage U_c	Auxiliary contacts fitted	Type	Order code	Pkg qty	Weight (1 pce)
12	2 2	KC6-22Z-P-07	GJH1213009R0227	10	0.170
24	2 2	KC6-22Z-P-01	GJH1213009R0221	10	0.170
48	2 2	KC6-22Z-P-16	GJH1213009R1226	10	0.170
110 ... 125	2 2	KC6-22Z-P-04	GJH1213009R0224	10	0.170
220 ... 240	2 2	KC6-22Z-P-05	GJH1213009R0225	10	0.170
24	3 1	KC6-31Z-P-01	GJH1213009R0311	10	0.170
48	3 1	KC6-31Z-P-16	GJH1213009R1316	10	0.170
110 ... 125	3 1	KC6-31Z-P-04	GJH1213009R0314	10	0.170
220 ... 240	3 1	KC6-31Z-P-05	GJH1213009R0315	10	0.170
12	4 0	KC6-40E-P-07	GJH1213009R0407	10	0.170
24	4 0	KC6-40E-P-01	GJH1213009R0401	10	0.170
48	4 0	KC6-40E-P-16	GJH1213009R1406	10	0.170
110 ... 125	4 0	KC6-40E-P-04	GJH1213009R0404	10	0.170
220 ... 240	4 0	KC6-40E-P-05	GJH1213009R0405	10	0.170

Other types on request

Main dimensions mm, inches

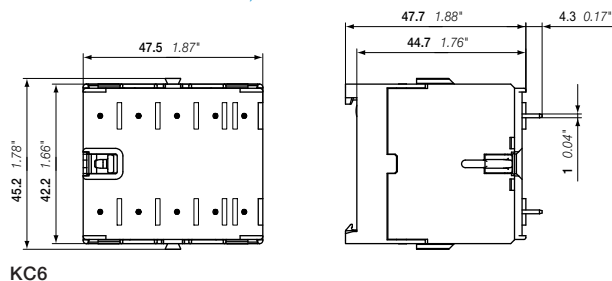

KC6

2CDC0210203F0011

2CDC102031C0201

BC6, BC7 3-pole interface mini contactors – with soldering pins

4 to 5.5 kW

DC operated



2CDC211030F0011

BC7-30-10-P

3

Description

BC6, BC7 3-pole interface mini contactors are compact control products mainly used for switching resistive or motor loads up to 690 V AC.

These contactors are designed with:

- 3 main poles and one built-in auxiliary contact
- control circuit: DC operated, low coil consumption (1.4 ... 2.4 W at pull-in and at holding)
- hum-free coil
- no auxiliary contact block permitted for mounting
- designed for soldering on PCB boards

Ordering details

IEC		UL/CSA		Rated control circuit voltage U_c	Auxiliary contacts fitted	Type	Order code	Pkg qty	Weight (1 pce)
Rated operational power	current $\theta \leq 55^\circ\text{C}$	3-phase motor rating	General use rating						
400 V AC-3 kW	AC-1 A	480 V hp	600 V AC A	V DC					kg
DC operation 24 V / 1.4 W									
4	12	3	3.4	24	1 0	BC6-30-10-P-1.4-81	GJL1213009R8101	10	0.170
					0 1	BC6-30-01-P-1.4-81	GJL1213009R8011	10	0.170
5.5	12	5	7.6	24	1 0	BC7-30-10-P-1.4-81	GJL1313009R8101	10	0.170
					0 1	BC7-30-01-P-1.4-81	GJL1313009R8011	10	0.170
DC operation 17 ... 32 V / 2.4 W, $I_{th} < 8\text{ A}$									
4	12	3	3.4	17 ... 32	1 0	BC6-30-10-P-2.4-51	GJL1213009R5101	10	0.170
					0 1	BC6-30-01-P-2.4-51	GJL1213009R5011	10	0.170
5.5	12	5	7.6	17 ... 32	1 0	BC7-30-10-P-2.4-51	GJL1313009R5101	10	0.170
					0 1	BC7-30-01-P-2.4-51	GJL1313009R5011	10	0.170

Other types on request

Main dimensions mm, inches

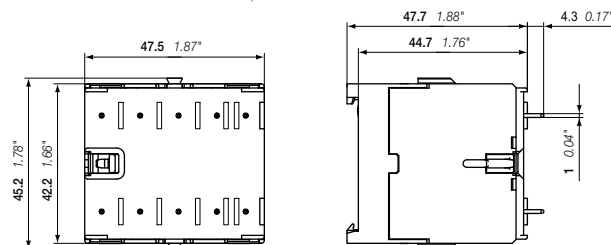

BC6, BC7

2CDC212009F0011

2CDC102029C0201

KC6 4-pole interface mini contactor relays – with solderings pins DC operated



KC6-31Z-P-1.4

2CDC211023F0011

Description

KC6 4-pole interface mini contactor relays are space optimized control products mainly used for control functions or for small loads up to 4 A.

These contactors are designed with:

- 4 poles with various contact combinations
- control circuit: DC operated, low coil consumption (3.5 W at pull-in and at holding)
- hum-free coil
- add-on auxiliary contact block for side mounting
- designed for soldering on PCB boards

Ordering details

Rated control circuit voltage U_c	Auxiliary contacts fitted	Type	Order code	Pkg qty	Weight (1 pce)
V DC					kg
DC operation 24 V / 1.4 W					
24	3 1	KC6-31Z-P-1.4-81	GJH1213009R8311	10	0.170
24	4 0	KC6-40E-P-1.4-81	GJH1213009R8401	10	0.170
DC operation 17 ... 32 V / 2.4 W					
17 ... 32	3 1	KC6-31Z-P-2.4-51	GJH1213009R5311	10	0.170
17 ... 32	4 0	KC6-40E-P-2.4-51	GJH1213009R5401	10	0.170

Other types on request

Main dimensions mm, inches

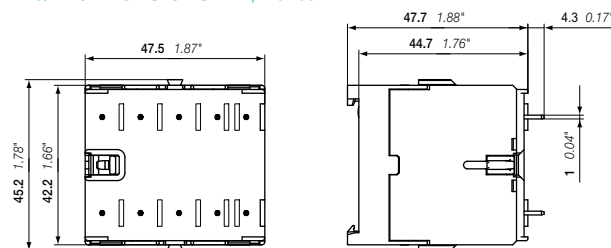

KC6

2CDC212003F0011

2CDC102032C0201

B6, B7, BC6, BC7 3- and 4-pole mini contactors

VB6, VB7, VBC6, VBC7 3-pole mini reversing contactors

Accessories



CAF6-11N

2CDC211012S0010



RV-BC6/250

2CDC211007S0010



CA6-11E

2CDC211008S0010

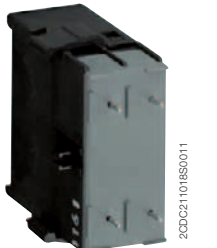

CA6-11E-P

2CDC211019S0011



BSM6-30

5S17792R



T16

2CDC231012P0011

Ordering details

For contactors	Auxiliary contacts	Type	Order code	Pkg qty	Weight (1 pce)
					kg

Front-mounted instantaneous auxiliary contact blocks (not allowed for mounting on TBC, B6S, B7S, interface contactors) ¹⁾

B6-, B7-40-00, BC6-, BC7-40-00	1 1	CAF6-11E	GJL1201330R0002	10	0.020
VB6, VB7, VBC6, VBC7, VB6A, VB7A	2 0	CAF6-20E	GJL1201330R0006	10	0.020
	0 2	CAF6-02E	GJL1201330R0010	10	0.020
B6-, B7-30-10, BC6-, BC7-30-10	1 1	CAF6-11M	GJL1201330R0003	10	0.020
VB6, VB7, VBC6, VBC7, VB6A, VB7A	2 0	CAF6-20M	GJL1201330R0007	10	0.020
	0 2	CAF6-02M	GJL1201330R0011	10	0.020
B6-, B7-30-01, BC6-, BC7-30-01	1 1	CAF6-11N	GJL1201330R0004	10	0.020
VB6, VB7, VBC6, VBC7, VB6A, VB7A	2 0	CAF6-20N	GJL1201330R0008	10	0.020
VBC6A, VBC7A	0 2	CAF6-02N	GJL1201330R0012	10	0.020

Side-mounted instantaneous auxiliary contact block ¹⁾

B6-, B7-40-00, BC6-, BC7-40-00	1 1	CA6-11E	GJL1201317R0002	10	0.030
B6-, B7-30-10, BC6-, BC7-30-10	1 1	CA6-11M	GJL1201317R0003	10	0.030
B6-, B7-30-01, BC6-, BC7-30-01	1 1	CA6-11N	GJL1201317R0004	10	0.030

Side-mounted instantaneous auxiliary contact block with soldering pins ¹⁾

B6-, B7-40-00-P, BC6-, BC7-40-00-P	1 1	CA6-11E-P	GJL1201319R0002	10	0.025
B6-, B7-30-10-P, BC6-, BC7-30-10-P	1 1	CA6-11M-P	GJL1201319R0003	10	0.025
B6-, B7-30-01-P, BC6-, BC7-30-01-P	1 1	CA6-11N-P	GJL1201319R0004	10	0.025

Soldering receptacle (I_e < 8 A)

B6, B7, BC6, BC7	LB6	GJL1201902R0001	10	0.020
2-pole aux.contact blocks CA	LB6-CA	GJL1201903R0001	10	0.010

¹⁾ CA6 and CAF6 must not be fitted simultaneously.

For contactors	Rated control circuit voltage U _c V DC	Connection type	Type	Order code	Pkg qty	Weight (1 pce) kg
----------------	---	-----------------	------	------------	---------	-------------------

Surge suppressors for contactor coils

BC6, BC7	24 ... 60	Cable lug	RV-BC6/60	GHV2501902R0002	10	0.005
		Flat pin, 2.8 mm	RV-BC6-F/60	GHV2501902R0003	10	0.005
	50 ... 250	Cable lug	RV-BC6/250	GHV2501903R0002	10	0.005
		Flat pin, 2.8 mm	RV-BC6-F/250	GHV2501903R0003	10	0.010
	380	Cable lug	RV-BC6/380	GHV2501904R0002	10	0.005
		Flat pin, 2.8 mm	RV-BC6-F/380	GHV2501904R0003	10	0.010

Note: Mini contactors for AC operation have an integrated protective circuit

Connecting links with manual motor starters

To connect B..VB.. mini contactor to MS116, MS132	BEA7/132	1SBN080906R1002	10	0.013
To connect B..VB.. mini contactors to MS325	BEA7/325	1SBN080906R1001	10	0.021

Connection sets for reversing contactors

VB6, VB7, VBC6, VBC7, VB6A, VB7A, VBC6A, VBC7A, cross-section 1.8 mm ²	BSM6-30	GJL1201908R0001	10	0.010
---	---------	-----------------	----	-------

Parallel connecting link

B6, B7, BC6, BC7	LP6	GJL1201907R0001	100	0.009
------------------	-----	-----------------	-----	-------

Cover cap, transparent fitting to DIN rail design, sealable

B6, B7, BC6, BC7	LT6-B	GJL1201906R0001	10	0.015
------------------	-------	-----------------	----	-------

Overload relays fitting details ²⁾

Contactor types	Thermal overload relays	Electronic overload relays
B6, B7, BC6, BC7	T16 (0.10...16 A)	E16DU (0.10...18.9 A)

²⁾ Direct mounting - No kit required. Ordering details, see overload relays section.

K6, KC6 4-pole mini contactor relays

Accessories



CAF6-11K

2DCD211019S0011



CA6-11K

2DCD211009S0010



CA6-11K-P

2DCD211019S0010



LT6-B

2DCD211008S0010



RV-BC6/250

2DCD211007S0010

Ordering details

For contactors	Auxiliary contacts	Type	Order code	Pkg qty	Weight (1 pce)
					kg

Front-mounted instantaneous auxiliary contact blocks ¹⁾

K6, KC6	1 1	CAF6-11K	GJL1201330R0001	10	0.020
	2 0	CAF6-20K	GJL1201330R0005	10	0.020
	0 2	CAF6-02K	GJL1201330R0009	10	0.020

Side-mounted instantaneous auxiliary contact block ¹⁾

K6, KC6	1 1	CA6-11K	GJL1201317R0001	10	0.030
---------	-----	---------	-----------------	----	-------

Side-mounted instantaneous auxiliary contact block with soldering pins ¹⁾

K6..P, KC6..P	1 1	CA6-11K-P	GJL1201319R0001	10	0.025
---------------	-----	-----------	-----------------	----	-------

Soldering receptacle ($I_e < 8 A$)

K6, KC6		LB6	GJL1201902R0001	10	0.020
2-pole auxiliary contact blocks CA		LB6-CA	GJL1201903R0001	10	0.010

¹⁾ CA6 and CAF6 must not be fitted simultaneously.

For contactors	Rated control circuit voltage U_c V DC	Connection type	Type	Order code	Pkg qty	Weight (1 pce) kg
----------------	---	-----------------	------	------------	---------	----------------------

Surge suppressors for contactor coils

KC6	24 ... 60	Cable lug	RV-BC6/60	GHV2501902R0002	10	0.005
		Flat pin, 2.8 mm	RV-BC6-F/60	GHV2501902R0003	10	0.005
	50 ... 250	Cable lug	RV-BC6/250	GHV2501903R0002	10	0.005
		Flat pin, 2.8 mm	RV-BC6-F/250	GHV2501903R0003	10	0.010
	380	Cable lug	RV-BC6/380	GHV2501904R0002	10	0.005
		Flat pin, 2.8 mm	RV-BC6-F/380	GHV2501904R0003	10	0.010

Note: Mini contactors for AC operation have an integrated protective circuit

Cover cap, transparent fitting to DIN rail design, sealable



K6, KC6		LT6-B	GJL1201906R0001	10	0.015
---------	--	-------	-----------------	----	-------

B6, B7, BC6, BC7, TBC7 3- and 4-pole mini contactors

VB6, VB7, VBC6, VBC7 3- and 4-pole mini reversing contactors

Technical data

Main pole – Utilization characteristics according to IEC

Contactor types	AC operated	B6, VB6, VB6A	B7, VB7, VB7A
	DC operated	BC6, VBC6, VBC6A	BC7, TBC7, VBC7, VBC7A
Standards	IEC 60947-1 / 60947-4-1 and EN 60947-1 / 60947-4-1		
Rated operational voltage $U_{e,max}$	690 V AC		
Rated frequency (without derating)	DC or 50 / 60 Hz		
Conventional free-air thermal current I_{th} acc. to IEC 60947-4-1, open contactors, $\theta \leq 40$ °C, with conductor cross-sectional area	20 A		
AC-1 Utilization category for air temperature close to contactor $\theta \leq 40$ °C			
I_e / Rated operational current AC-1 $U_{e,max} \leq 690$ V, 50/60 Hz	220-230-240 V	Screw terminal types: 20 A Soldering pin types: 12 A Flat pin types: 16 A	
	380-400 V	Screw terminal types: 20 A Soldering pin types: 12 A Flat pin types: 16 A	
	440 V	Screw terminal types: 20 A Soldering pin types: 12 A Flat pin types: 16 A	
	500 V	12 A	
	690 V	6 A	
	AC-1 Utilization category for air temperature close to contactor $\theta \leq 55$ °C		
I_e / Rated operational current AC-1 $U_{e,max} \leq 690$ V, 50/60 Hz	220-230-240 V	Screw terminal types: 16 A Soldering pin types: 12 A Flat pin types: 16 A	Screw terminal types: 20 A Soldering pin types: 12 A Flat pin types: 16 A
	380-400 V	Screw terminal types: 16 A Soldering pin types: 12 A Flat pin types: 16 A	Screw terminal types: 20 A Soldering pin types: 12 A Flat pin types: 16 A
	440 V	Screw terminal types: 16 A Soldering pin types: 12 A Flat pin types: 16 A	Screw terminal types: 20 A Soldering pin types: 12 A Flat pin types: 16 A
	500 V	12 A	
	690 V	6 A	
	AC-3 Utilization category for air temperature close to contactor $\theta \leq 55$ °C		
I_e / Rated operational current AC-3 	220-230-240 V	9 A	12 A
	380-400 V	8 A	12 A
	440 V	8 A	12 A
	500 V	6.5 A	9 A
	690 V	3.5 A	3.5 A
	Rated operational power AC-3  1500 r.p.m. 50 Hz 1800 r.p.m. 60 Hz 3-phase motors	220-230-240 V	2.2 kW
380-400 V		4 kW	5.5 kW
440 V		4 kW	5.5 kW
500 V		3 kW	4 kW
690 V		3 kW	3 kW
DC-1 Utilization category for air temperature close to contactor $\theta \leq 55$ °C			
I_e / Rated operational current DC-1	110 V	-	4 A
	220 V	-	0.6 A
DC-3 Utilization category for air temperature close to contactor $\theta \leq 55$ °C			
I_e / Rated operational current DC-3	110 V	-	1.5 A
	220 V	-	0.25 A
DC-5 Utilization category for air temperature close to contactor $\theta \leq 55$ °C			
I_e / Rated operational current DC-5	110 V	-	0.4 A
	220 V	-	0.2 A
Rated making capacity AC-3	10 x I_e AC-3 acc. to IEC 60947-4-1		
Rated breaking capacity AC-3	8 x I_e AC-3 acc. to IEC 60947-4-1		
Short-circuit protection device for contactors without thermal O/L relay - motor protection excluded $U_e \leq 500$ V AC - gG type fuse			
		Coordination type 1: 25 A / Coordination type 2: 20 A	
Rated short-time withstand current I_{cw} at 40 °C ambient temperature, in free air from a cold state	10 s	64 A	96 A
Maximum breaking capacity $\cos \phi = 0.45$	at 400 V	64 A	96 A
Maximum electrical switching frequency	AC-1	300 cycles/h	
	AC-3	600 cycles/h	
	DC-1, DC-3, DC-5	600 cycles/h	

B6, B7, BC6, BC7, TBC7 3- and 4-pole mini contactors VB6, VB7, VBC6, VBC7 3- and 4-pole mini reversing contactors

Technical data

Main pole – Utilization characteristics according to UL/NEMA/CSA

Contactor types	AC operated	B6, VB6, VB6A	B7, VB7, VB7A
	DC operated	BC6, VBC6, VBC6A	BC7, TBC7, VBC7, VBC7A
Standards	UL 508, CSA C22.2 N°14		
Maximum operational voltage	600 V		
UL/CSA general use rating	12 A		16 A
UL/CSA maximum 1-phase motor rating			
Full load current	120 V AC	8.4 A	13.8 A
	240 V AC	6.8 A	10.0 A
Horse power rating	120 V AC	1 hp	0.75 hp
	240 V AC	2 hp	1.5 hp
UL/CSA maximum 3-phase motor rating			
Full load current ¹⁾	200-208 V AC	4.6 A	7.5 A
	220-240 V AC	6.8 A	9.6 A
	440-480 V AC	3.4 A	7.6 A
	550-600 V AC	1.7 A	6.1 A
Horse power rating ¹⁾	200-208 V AC	1 hp	2 hp
	220-240 V AC	2 hp	3 hp
	440-480 V AC	3 hp	5 hp
	550-600 V AC	1 hp	5 hp
Short-circuit protection device for contactors without thermal overload relay - motor protection excluded			
Fuse rating	600 V	40 A	
Fuse type	600 V	Class J	
Maximum electrical switching frequency			
For resistive loads AC-1	300 cycles/h		
For motor loads AC-3	600 cycles/h		

¹⁾ For the corresponding kW/A or hp/A values of 1500 r.p.m, 50 Hz or 1800 r.p.m, 60 Hz, 3-phase motors, see "Motor rated operational powers and currents".

General technical data

Contactor types	AC operated	B6, VB6, VB6A	B7, VB7, VB7A
	DC operated	BC6, VBC6, VBC6A	BC7, TBC7, VBC7, VBC7A
Rated insulation voltage U _i			
acc. to IEC 60947-4-1	690 V		
acc. to UL/CSA	600 V		
Rated impulse withstand voltage U _{imp}	6 kV		
Ambient air temperature, close to contactor			
Operation	Fitted with thermal overload relay	-25 ... +55 °C	
	Without thermal overload relay	-25 ... +55 °C	
Storage	-40 ... +80 °C		
Climatic withstand	acc. to IEC 60947-1 Annex Q		
Maximum operating altitude (without derating)	2000 m		
Mechanical durability	10 ⁷ operating cycles		
Resistance to shock	Half-sine		
acc. to IEC 60068-2-27 and EN 60068-2-27	15 g / 11 ms		
acc. to IEC/EN 60947-1 Annex. Q	Category E		
Resistance to vibrations	Sinusoidal		
acc. to IEC 60068-2-27 and EN 60068-2-27	5 g / 3 ... 150 Hz		
acc. to IEC/EN 60947-1 Annex. Q	Category E		

B6, B7, BC6, BC7, TBC7 3- and 4-pole mini contactors VB6, VB7, VBC6, VBC7 3- and 4-pole mini reversing contactors

Technical data

Magnet system characteristics for B6, B7 contactors

Contactor types	AC operated	B6, VB6	B7, VB7
Coil operating limits acc. to IEC 60947-4-1	AC supply	0.85 ... 1.1 x U _c	
AC control voltage			
Rated control circuit voltage U _c	See ordering tables		
Coil consumption	Average pull-in value	3.5 VA / 3.5 W	
	Average holding value	3.5 VA / 3.5 W	
Drop-out voltage	0.20 ... 0.75 % of U _c		

Magnet system characteristics for BC6, BC7 contactors

Contactor types	DC operated	BC6, VBC6	BC7, VBC7
Coil operating limits acc. to IEC 60947-4-1	DC supply	0.85 ... 1.1 x U _c	
AC control voltage			
Rated control circuit voltage U _c	See ordering tables		
Coil consumption ¹⁾	Average pull-in value	3.5 VA / 3.5 W	
	Average holding value	3.5 VA / 3.5 W	
Drop-out voltage in % of U _{c min}	0.10 ... 0.75 x U _c		

¹⁾ Interface mini-contactors: see coil consumption on ordering details pages

Magnet system characteristics for TBC7 contactors

Contactor types	DC operated	TBC7
Coil operating limits acc. to IEC 60947-4-1	DC supply	Wide range voltage supply see ordering tables, U _{c min} ... U _{c max}
AC control voltage		
Rated control circuit voltage U _c	See ordering tables	
Coil consumption	Average pull-in value	5 VA / 5 W
	Average holding value	5 VA / 5 W
Drop-out voltage in % of U _{c min}	≤ 0.20 % of U _{c min}	

Mounting characteristics and conditions for use

Contactor types	AC operated	B6, VB6, VB6A	B7, VB7, VB7A
	DC operated	BC6, VBC6, VBC6A	BC7, TBC7, VBC7, VBC7A
Mounting positions			
Mounting distances	The contactors can be assembled side by side		
Fixing	<p>On rail acc. to IEC 60715, EN 60715 35 x 7.5 mm or 35 x 15 mm</p> <p>By screws (not supplied) 2 x M4 screws placed diagonally</p>		

B6, B7, BC6, BC7, TBC7 3- and 4-pole mini contactors VB6, VB7, VBC6, VBC7 3- and 4-pole mini reversing contactors

Technical data

Built-in auxiliary contacts according to IEC

Contactor types	AC operated	B6, VB6, VB6A	B7, VB7, VB7A
	DC operated	BC6, VBC6, VBC6A	BC7, TBC7, VBC7, VBC7A
Standards	IEC 60947-1 / 60947-4-1 and EN 60947-1 / 60947-4-1		
Rated operational voltage U _e max	690 V		
Rated frequency (without derating)	DC or 50 / 60 Hz		
Conventional free-air thermal current I _{th} θ ≤ 40 °C	6 A		
I _e / Rated operational current AC-15 acc. to IEC 60947-5-1	24 V 50/60 Hz	4 A	
	110-120 V 50/60 Hz	4 A	
	220-230-240 V 50/60 Hz	4 A	
	380-400 V 50/60 Hz	3 A	
	440 V 50/60 Hz	3 A	
I _e / Rated operational current DC-13 acc. to IEC 60947-5-1	24 V DC	2.5 A	
	110 V DC	0.7 A	
	220 - 240 V DC	0.4 A	
Short-circuit protection device	6 A, Type gG		
Minimum switching capacity with failure rate acc. to IEC 60947-5-4	17 V / 5 mA		
Maximum electrical switching frequency	AC-15	600 cycles/h	
	DC-13	600 cycles/h	





Built-in auxiliary contacts according to UL/CSA

Contactor types	AC operated	B6, VB6, VB6A	B7, VB7, VB7A
	DC operated	BC6, VBC6, VBC6A	BC7, VBC7, VBC7A
Max. operational voltage	600 V AC		
Pilot duty	A600		
AC thermal rated current	5 A		

B6, B7, BC6, BC7, TBC7 3- and 4-pole mini contactors VB6, VB7, VBC6, VBC7 3- and 4-pole mini reversing contactors

Technical data

Connection characteristics

Contactor types	AC operated	B6, VB6, VB6A	B7, VB7, VB7A
	DC operated	BC6, VBC6, VBC6A	BC7, TBC7, VBC7, VBC7A
Main terminals ¹⁾	 <p>Screw terminals with cable clamp</p>		
Connection capacity			
Main conductors (poles)			
 Rigid: solid	1 or 2 x	1 ... 4 mm ²	
 Flexible without ferrule	1 or 2 x	1 ... 2.5 mm ²	
Connection capacity acc. to UL/CSA	1 or 2 x	AWG 22 ... 10	
Stripping length		9 mm	
Tightening torques		0.8 ... 1.1 Nm / 7 lb.in	
Connection capacity – auxiliary conductors (built-in auxiliary terminals + coil terminals)			
 Rigid: solid	1 or 2 x	1 ... 4 mm ²	
 Flexible without ferrule	1 or 2 x	1 ... 2.5 mm ²	
Connection capacity acc. to UL/CSA	1 or 2 x	AWG 22 ... 10	
Stripping length		9 mm	
Tightening torques		0.8 ... 1.1 Nm / 7 lb.in	
Coil terminals		0.8 ... 1.1 Nm / 7 lb.in	
Built-in auxiliary terminals		0.8 ... 1.1 Nm / 7 lb.in	
Degree of protection acc. to IEC 60947-1 / EN 60947-1 and IEC 60529 / EN 60529			
Main terminals		IP20	
Coil terminals		IP20	
Built-in auxiliary terminals		IP20	
Screw terminals (Delivered in open position, screws of unused terminals must be tightened)			
All terminals		M3	
Screwdriver type Flat Ø 5.5 mm / Pozidriv 1			

¹⁾ Soldering pin connection acc. to DIN 40801: 0.8 x 1 mm / 0.8 x 2.54 mm
Flat pin connection acc. to DIN 46248: 1 x 6.3 mm / 1 x 2.8 mm

K6, KC6, TKC6 4-pole mini contactor relays

Technical data

Main pole – Utilization characteristics according to IEC

Contactor types	AC operated	K6
	DC operated	KC6, TKC6
Standards	IEC 60947-1 / 60947-5-1 and EN 60947-1 / 60947-5-1	
Rated operational voltage $U_{e,max}$	690 V	
Rated frequency (without derating)	DC or 50 / 60 Hz	
Conventional free-air thermal current $I_{th} \theta \leq 40 \text{ °C}$	6 A	
I_e / Rated operational current AC-15 acc. to IEC 60947-5-1	24 V 50/60 Hz	4 A
	110-120 V 50/60 Hz	4 A
	220-230-240 V 50/60 Hz	4 A
	380-400 V 50/60 Hz	3 A
	440 V 50/60 Hz	3 A
	480-500 V 50/60 Hz	2 A
I_e / Rated operational current DC-13 acc. to IEC 60947-5-1	24 V DC	2.5 A
	110 V DC	0.7 A
	220 - 240 V DC	0.4 A
Short-circuit protection device for contactors $U_e \leq 500 \text{ V AC}$, gG fuse type	6 A	
Minimum switching capacity	17 V / 5 mA	
Maximum electrical switching frequency	AC-15	600 cycles/h
	DC-13	600 cycles/h

Main pole – Utilization characteristics according to UL/NEMA/CSA

Contactor types	AC operated	K6
	DC operated	KC6
Standards	UL 508, CSA C22.2 No14	
Maximum operational voltage	600 V AC	
Pilot duty	A600	

K6, KC6, TKC6 4-pole mini contactor relays

Technical data

General technical data

Contactor relay types	AC operated	K6
	DC operated	KC6, TKC6
Rated insulation voltage U_i	acc. to IEC 60947-5-1	690 V
	acc. to UL/CSA	600 V
Rated impulse withstand voltage U_{imp}		6 kV
Electromagnetic compatibility		
Ambient air temperature close to contactor relay	Operation in free air	-25 ... +55 °C
	Storage	-40 ... +80 °C
Climatic withstand		acc. to IEC 60068-2-30
Maximum operating altitude (without derating)		2000 m
Mechanical durability		10 ⁷ operating cycles
Resistance to shock		Half-sine
	acc. IEC 60068-2-27 and EN 60068-2-27	15 g / 11ms
	acc. to IEC/EN 60947-1 Annex. Q	Category E
Resistance to vibrations		Sinusoidal
	acc. IEC 60068-2-27 and EN 60068-2-27	5 g / 3 ... 150 Hz
	acc. to IEC/EN 60947-1 Annex. Q	Kategorie E

Magnet system characteristics for K6 contactor relays

Contactor relay types	AC operated	K6
Coil operating limits acc. to IEC 60947-4-1	AC supply	0.85 ... 1.1 x U_c
AC control voltage		
Coil consumption	Average pull-in value	3.5 VA / 3.5 W
	Average holding value	3.5 VA / 3.5 W
Drop-out voltage in % of U_c min.		Approx. 20 ... 75%

Magnet system characteristics for KC6, TKC6 contactor relays

Contactor relay types	DC operated	KC6	TKC6
Coil operating limits acc. to IEC 60947-5-1	DC supply	0.85 ... 1.1 x U_c	See ordering details
DC control voltage			
Coil consumption	Average pull-in value	3.5 VA / 3.5 W	5 VA / 5 W
	Average holding value	3.5 VA / 3.5 W	5 VA / 5 W
Drop-out voltage in % of U_c min.		10 ... 75 %	10 ... 75 %

K6, KC6, TKC6 4-pole mini contactor relays

Technical data

Mounting characteristics and conditions for use

Contactor types	AC operated K6 DC operated KC6, TKC6
Mounting positions	
Mounting distances	The contactors can be assembled side by side.
Fixing	<p>On rail acc. to IEC 60715, EN 60715 35 x 7.5 mm or 35 x 15 mm</p> <p>By screws (not supplied) 2 x M4 screws placed diagonally</p>

Connecting characteristics

Contactor relay types	AC operated K6 DC operated KC6, TKC6
Main terminals ¹⁾	<p>Screw terminals with cable clamp</p>
Connection capacity	
Main conductors (poles)	
Rigid: solid	1 or 2 x 1 ... 4 mm ²
Flexible without ferrule	1 or 2 x 1 ... 2.5 mm ²
Connection capacity acc. to UL/CSA	1 or 2 x AWG 22 ... 10
Stripping length	9 mm
Tightening torques	0.8 ... 1.1 Nm / 7 lb.in
Degree of protection	
acc. to IEC 60947-1 / EN 60947-1 and IEC 60529 / EN 60529	
All	IP20
Screw terminals	(Delivered in open position, screws of unused terminals must be tightened)
All terminals	M3
Screwdriver type	Flat Ø 5.5 / Pozidriv 1

¹⁾ Soldering pin connection acc. to DIN 40801: 0.8 x 1 mm / 0.8 x 2.54 mm
Flat pin connection acc. to DIN 46248: 1 x 6.3 mm / 1 x 2.8 mm

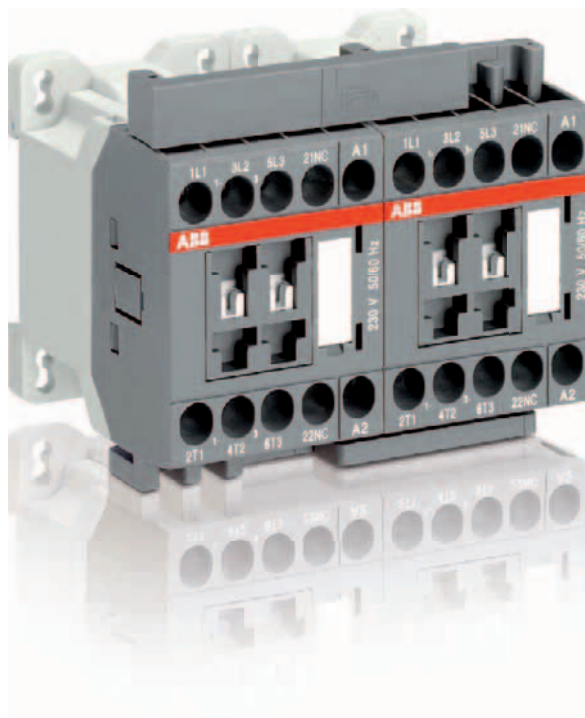

AS contactors

NS contactor relays

3-pole contactors

Overview	4/2
AS09 ... AS16 AC operated	4/4
ASL09 ... ASL16 DC operated	4/5
AS09 ... AS16 AC operated - 2-stack	4/6
ASL09 ... ASL16 DC operated - 2-stack	4/7
Main accessories	4/8
Technical data	4/10

3-pole reversing contactors

VAS09 ... VAS16 AC operated	4/16
VASL09 ... VASL16 DC operated	4/17
Technical data	4/18

Contactor relays

Overview	4/22
NS AC operated	4/24
NSL DC operated	4/25
Main accessories	4/26
Technical data	4/28

Accessories 4/31

Voltage coil table 4/37

3-pole contactors

Main accessories

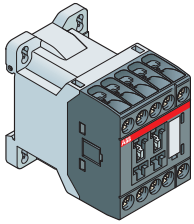

AS09 ... AS16
3-pole contactors

4

Main accessories for contactors

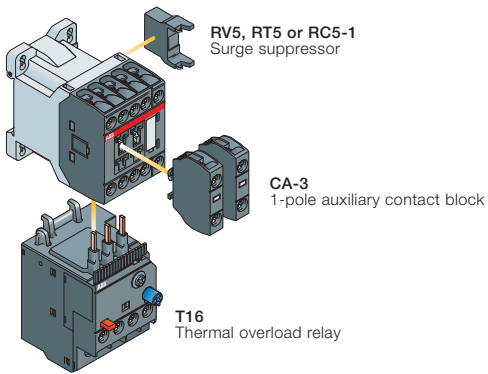

Main accessories for starting solutions

Direct-on-line starter

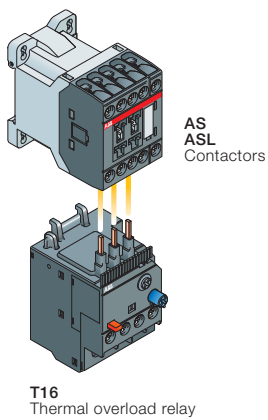

Reversing starter

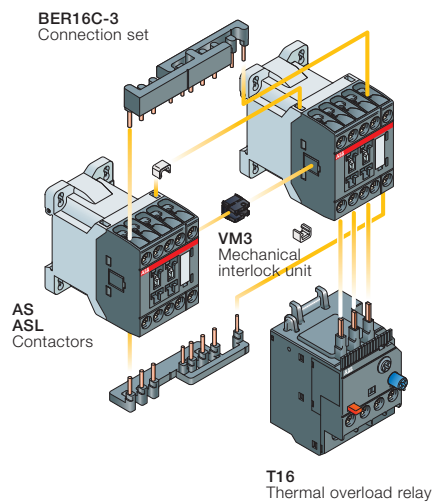

Star-delta starter

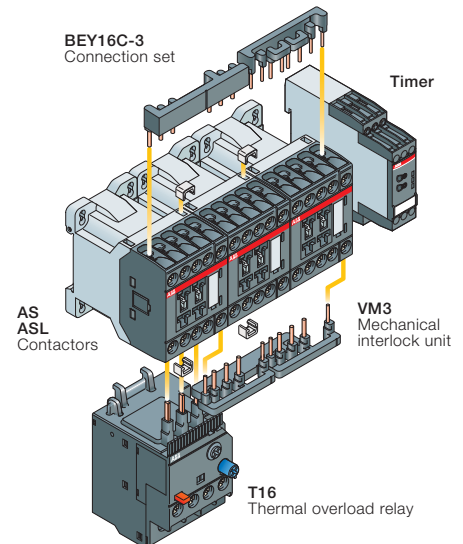

3-pole contactors



Screw terminals



	AC control voltage	AS09	AS12	AS16
	DC control voltage	ASL09	ASL12	ASL16

4

Switching of 3-phase cage motors

	IEC	AC-3	Rated operational power	400 V	4 kW	5.5 kW	7.5 kW	
			Rated operational current	$\theta \leq 60\text{ }^{\circ}\text{C}$	400 V	9 A	12 A	15.5 A
				$\theta \leq 60\text{ }^{\circ}\text{C}$	415 V	9 A	12 A	15.5 A
				$\theta \leq 60\text{ }^{\circ}\text{C}$	690 V	5 A	7 A	9 A
UL / CSA	3-phase motor rating		440-480 V	5 hp	7.5 hp	10 hp		
	NEMA size			00	00	0		

Protection of 3-phase motors

Thermal overload relays



T16...

0.10...0.13	0.23...0.31	0.55...0.74	1.30...1.70	3.10...4.20	7.60...10.0
0.13...0.17	0.31...0.41	0.74...1.00	1.70...2.30	4.20...5.70	10.0...13.0
0.17...0.23	0.41...0.55	1.00...1.30	2.30...3.10	5.70...7.60	13.0...16.0

Switching of resistive circuits

	IEC	AC-1	Rated operational current	$\theta \leq 40\text{ }^{\circ}\text{C}$	690 V	22 A	24 A	24 A
				$\theta \leq 60\text{ }^{\circ}\text{C}$	690 V	18 A	20 A	20 A
				$\theta \leq 70\text{ }^{\circ}\text{C}$	690 V	15 A	16 A	16 A
		With conductor cross-sectional area				2.5 mm ²	2.5 mm ²	2.5 mm ²
UL / CSA	General use rating		600 V AC		20 A	20 A	20 A	
	With conductor cross-sectional area				AWG 12	AWG 12	AWG 12	

Main accessories

Auxiliary contact blocks	Front mounting		1-pole CA3-10 or CA3-01
Interlocks	Mechanical		VM3
Surge suppressors	Side-mounted (without additional width)		RV5 (Varistor) AC / DC RC5-1 (Capacitor) AC RT5 (Transil diode) DC
Connection sets	Reversing starters Star-delta starters		BER16C-3 BEY16C-3
Connecting link	With manual motor starter		BEA16-3

1SEC101292S0201

AS09 ... AS16 3-pole contactors

4 to 7.5 kW

AC operated



AS09-30-10

1SBC101007F0014

Description

AS09 ... AS16 contactors are mainly used for controlling 3-phase motors and power circuits up to 690 V AC and 220 V DC.

These contactors are of the block type design with:

- 3 main poles and 1 built-in auxiliary contact
- control circuit: AC operated
- add-on auxiliary contact blocks for front mounting and a comprehensive range of accessories.

Ordering details

IEC Rated operational power 400 V AC-3 kW	Rated operational current $\theta \leq 40^\circ\text{C}$ AC-1 A	UL/CSA 3-phase motor rating 480 V hp	General use rating 600 V AC A	Rated control circuit voltage Uc (1)		Auxiliary contacts fitted 	Type	Order code	Weight Pkg (1 pce) kg				
				V 50 Hz	V 60 Hz								
4	22	5	20	24	24	1 0	AS09-30-10-20	1SBL101001R2010	0.220				
						0 1	AS09-30-01-20	1SBL101001R2001	0.220				
				-	120	1 0	AS09-30-10-16	1SBL101001R1610	0.220				
						0 1	AS09-30-01-16	1SBL101001R1601	0.220				
				230	230	1 0	AS09-30-10-26	1SBL101001R2610	0.220				
						0 1	AS09-30-01-26	1SBL101001R2601	0.220				
				400	400	1 0	AS09-30-10-28	1SBL101001R2810	0.220				
						0 1	AS09-30-01-28	1SBL101001R2801	0.220				
				5.5	24	7.5	20	24	24	1 0	AS12-30-10-20	1SBL111001R2010	0.220
										0 1	AS12-30-01-20	1SBL111001R2001	0.220
-	120	1 0	AS12-30-10-16					1SBL111001R1610	0.220				
		0 1	AS12-30-01-16					1SBL111001R1601	0.220				
230	230	1 0	AS12-30-10-26					1SBL111001R2610	0.220				
		0 1	AS12-30-01-26					1SBL111001R2601	0.220				
400	400	1 0	AS12-30-10-28					1SBL111001R2810	0.220				
		0 1	AS12-30-01-28					1SBL111001R2801	0.220				
7.5	24	10	20					24	24	1 0	AS16-30-10-20	1SBL121001R2010	0.220
										0 1	AS16-30-01-20	1SBL121001R2001	0.220
				-	120	1 0	AS16-30-10-16	1SBL121001R1610	0.220				
						0 1	AS16-30-01-16	1SBL121001R1601	0.220				
				230	230	1 0	AS16-30-10-26	1SBL121001R2610	0.220				
						0 1	AS16-30-01-26	1SBL121001R2601	0.220				
				400	400	1 0	AS16-30-10-28	1SBL121001R2810	0.220				
						0 1	AS16-30-01-28	1SBL121001R2801	0.220				

Note: for multiple packaging, please contact your ABB local sales organization.

(1) Other control voltages see voltage code table.

Main dimensions mm, inches

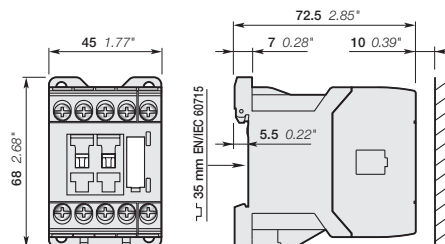

AS09, AS12, AS16

ASL09 ... ASL16 3-pole contactors

4 to 7.5 kW

DC operated



ASL09-30-10



Description

ASL09 ... ASL16 contactors are mainly used for controlling 3-phase motors and power circuits up to 690 V AC and 220 V DC.

These contactors are of the block type design with:

- 3 main poles and 1 built-in auxiliary contact
- control circuit: low consumption (3 W at pull-in and holding) DC operated with solid core magnet. Suitable for direct control by PLC outputs (the polarity on the coil terminals A1+ and A2- must be respected)
- add-on auxiliary contact blocks for front mounting and a comprehensive range of accessories.

Ordering details

IEC		UL/CSA		Rated control circuit voltage U _c (1)	Auxiliary contacts fitted	Type	Order code	Weight Pkg (1 pce)				
Rated operational power	Rated operational current θ ≤ 40 °C	3-phase motor rating 480 V	General use rating 600 V AC									
400 V AC-3 kW	AC-1 A	hp	A	V DC	 			kg				
4	22	5	20	24	1 0	ASL09-30-10-81	1SBL103001R8110	0.280				
					0 1	ASL09-30-01-81	1SBL103001R8101	0.280				
				48	1 0	ASL09-30-10-83	1SBL103001R8310	0.280				
					0 1	ASL09-30-01-83	1SBL103001R8301	0.280				
				110	1 0	ASL09-30-10-86	1SBL103001R8610	0.280				
					0 1	ASL09-30-01-86	1SBL103001R8601	0.280				
				220	1 0	ASL09-30-10-88	1SBL103001R8810	0.280				
					0 1	ASL09-30-01-88	1SBL103001R8801	0.280				
				5.5	24	7.5	20	24	1 0	ASL12-30-10-81	1SBL113001R8110	0.280
									0 1	ASL12-30-01-81	1SBL113001R8101	0.280
48	1 0	ASL12-30-10-83	1SBL113001R8310					0.280				
	0 1	ASL12-30-01-83	1SBL113001R8301					0.280				
110	1 0	ASL12-30-10-86	1SBL113001R8610					0.280				
	0 1	ASL12-30-01-86	1SBL113001R8601					0.280				
220	1 0	ASL12-30-10-88	1SBL113001R8810					0.280				
	0 1	ASL12-30-01-88	1SBL113001R8801					0.280				
7.5	24	10	20					24	1 0	ASL16-30-10-81	1SBL123001R8110	0.280
									0 1	ASL16-30-01-81	1SBL123001R8101	0.280
				48	1 0	ASL16-30-10-83	1SBL123001R8310	0.280				
					0 1	ASL16-30-01-83	1SBL123001R8301	0.280				
				110	1 0	ASL16-30-10-86	1SBL123001R8610	0.280				
					0 1	ASL16-30-01-86	1SBL123001R8601	0.280				
				220	1 0	ASL16-30-10-88	1SBL123001R8810	0.280				
					0 1	ASL16-30-01-88	1SBL123001R8801	0.280				

Note: for multiple packaging, please contact your ABB local sales organization.

(1) Other control voltages see voltage code table.

Main dimensions mm, inches

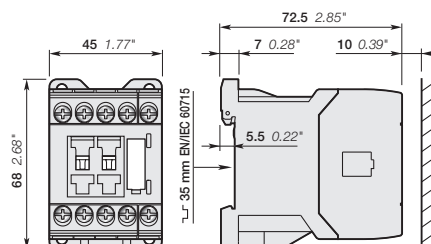

ASL09, ASL12, ASL16

AS09 ... AS16 2-stack 3-pole contactors

4 to 7.5 kW

AC operated



AS09-30-32

1SBC101332F0014

Description

AS09 ... AS16 contactors are mainly used for controlling 3-phase motors and power circuits up to 690 V AC and 220 V DC.

These contactors are of the block type design with:

- 1st stack with 3 main poles and 1 N.O. built-in auxiliary contact
- 2nd stack with permanently fixed 2 N.O. + 2 N.C. auxiliary contact block. The auxiliary contact elements are mechanically linked (side-marked symbol) and the N.C. auxiliary contacts are mirror contacts
- control circuit: AC operated
- a comprehensive range of accessories.

Ordering details

IEC Rated operational power 400 V AC-3 kW	current $\theta \leq 40^\circ\text{C}$ AC-1 A	UL/CSA 3-phase motor rating 480 V hp	General use rating 600 V AC A	Rated control circuit voltage U_c (1)		Auxiliary contacts fitted 	Type	Order code	Weight Pkg (1 pce) kg			
				V 50 Hz	V 60 Hz							
4	22	5	20	24	24	3 2	AS09-30-32-20	1SBL101001R2032	0.260			
				-	120					AS09-30-32-16	1SBL101001R1632	0.260
				230	230					AS09-30-32-26	1SBL101001R2632	0.260
				400	400					AS09-30-32-28	1SBL101001R2832	0.260
5.5	24	7.5	20	24	24	3 2	AS12-30-32-20	1SBL111001R2032	0.260			
				-	120					AS12-30-32-16	1SBL111001R1632	0.260
				230	230					AS12-30-32-26	1SBL111001R2632	0.260
				400	400					AS12-30-32-28	1SBL111001R2832	0.260
7.5	24	10	20	24	24	3 2	AS16-30-32-20	1SBL121001R2032	0.260			
				-	120					AS16-30-32-16	1SBL121001R1632	0.260
				230	230					AS16-30-32-26	1SBL121001R2632	0.260
				400	400					AS16-30-32-28	1SBL121001R2832	0.260

Note: for multiple packaging, please contact your ABB local sales organization.

(1) Other control voltages see voltage code table.

Main dimensions mm, inches

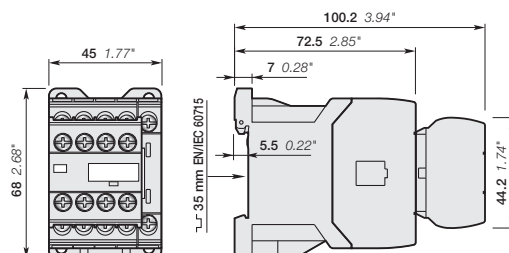

AS09, AS12, AS16

1SBC101303S0201

ASL09 ... ASL16 2-stack 3-pole contactors

4 to 7.5 kW

DC operated



ASL09-30-32

Description

ASL09 ... ASL16 contactors are mainly used for controlling 3-phase motors and power circuits up to 690 V AC and 220 V DC.

These contactors are of the block type design with:

- 1st stack with 3 main poles and 1 N.O. built-in auxiliary contact
- 2nd stack with permanently fixed 2 N.O. + 2 N.C. auxiliary contact block. The auxiliary contact elements are mechanically linked (side-marked symbol) and the N.C. auxiliary contacts are mirror contacts
- control circuit: low consumption (3 W at pull-in and holding) DC operated with solid core magnet. Suitable for direct control by PLC outputs (the polarity on the coil terminals A1+ and A2- must be respected)
- a comprehensive range of accessories.

Ordering details

IEC		UL/CSA		Rated control circuit voltage U _c (1)	Auxiliary contacts fitted	Type	Order code	Weight
Rated power	operational current θ ≤ 40 °C	3-phase motor rating 480 V	General use rating 600 V AC					
400 V AC-3	AC-1	hp	A	V DC	I L			kg
4	22	5	20	24	3 2	ASL09-30-32-81	1SBL103001R8132	0.320
				48	3 2	ASL09-30-32-83	1SBL103001R8332	0.320
				110	3 2	ASL09-30-32-86	1SBL103001R8632	0.320
				220	3 2	ASL09-30-32-88	1SBL103001R8832	0.320
5.5	24	7.5	20	24	3 2	ASL12-30-32-81	1SBL113001R8132	0.320
				48	3 2	ASL12-30-32-83	1SBL113001R8332	0.320
				110	3 2	ASL12-30-32-86	1SBL113001R8632	0.320
				220	3 2	ASL12-30-32-88	1SBL113001R8832	0.320
7.5	24	10	20	24	3 2	ASL16-30-32-81	1SBL123001R8132	0.320
				48	3 2	ASL16-30-32-83	1SBL123001R8332	0.320
				110	3 2	ASL16-30-32-86	1SBL123001R8632	0.320
				220	3 2	ASL16-30-32-88	1SBL123001R8832	0.320

Note: for multiple packaging, please contact your ABB local sales organization.

(1) Other control voltages see voltage code table.

Main dimensions mm, inches

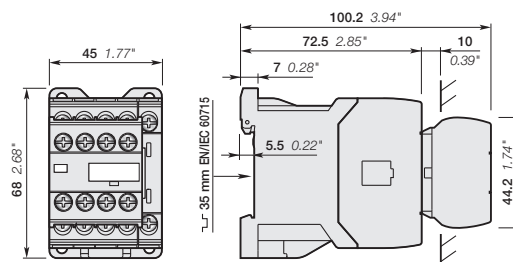

ASL09, ASL12, ASL16

AS09 ... AS16 and ASL09 ... ASL16 3-pole contactors

Main accessories

Contactor and main accessories (other accessories available)

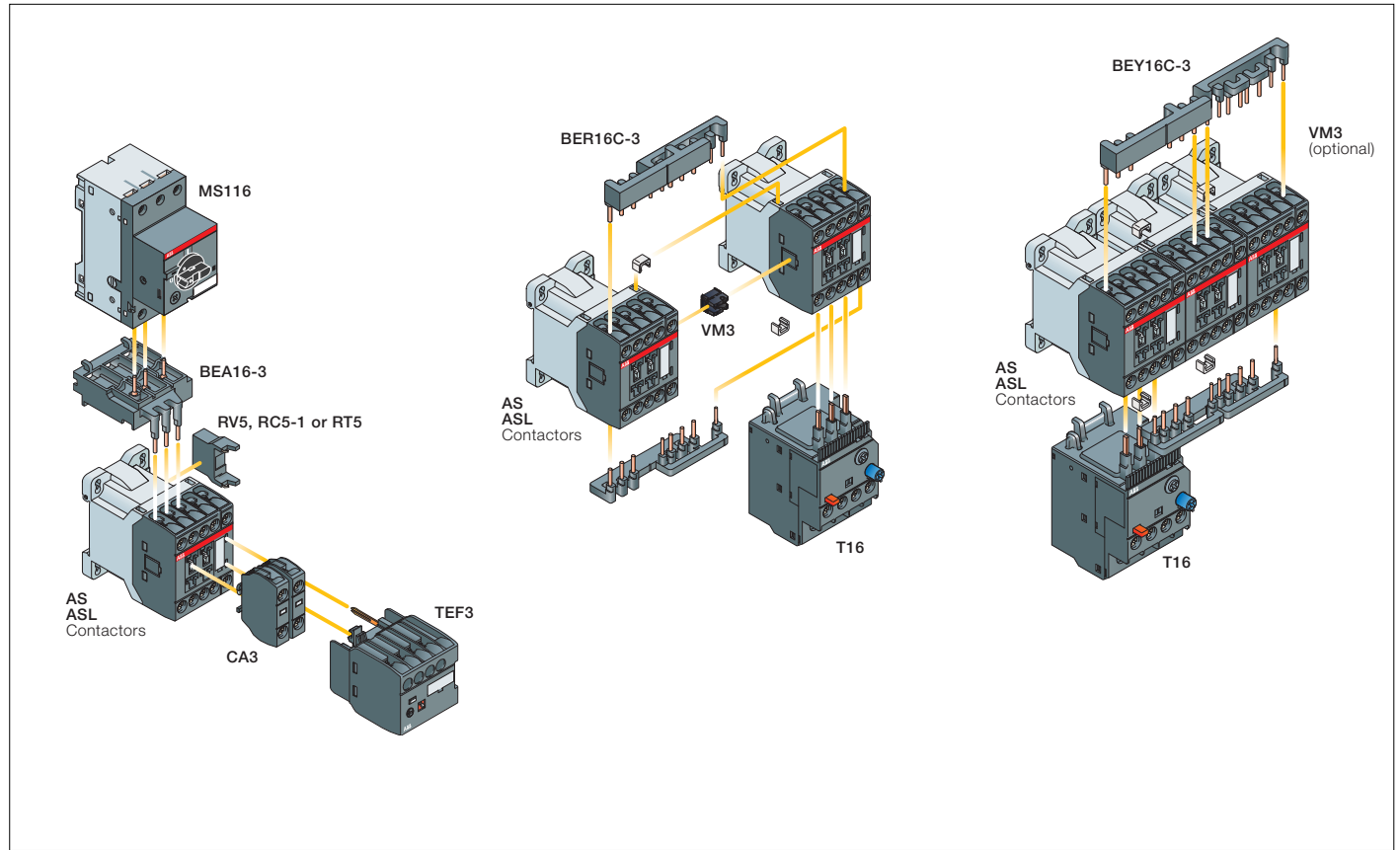

Main accessory fitting details

Many configurations of accessories are possible depending on whether these are front-mounted or side-mounted.

Contactor types	Main poles	Built-in auxiliary contacts	Front-mounted accessories			Side-mounted accessories	
			Auxiliary contact blocks	Electronic timer	Mechanical interlock unit (between 2 contactors)	Surge suppressors	
AS09 ... AS16	3 0	1 0	2 max.	or 1	+ 1	+ RV5	or RC5-1
	3 0	0 1	-	-	1	+ RV5	or RC5-1
ASL09 ... ASL16	3 0	1 0	2 max.	or 1	+ 1	+ RV5	or RT5
	3 0	0 1	-	-	1	+ RV5	or RT5

Overload relays fitting details (1)

Contactor types	Thermal overload relays
AS09 ... AS16	T16 (0.10...16 A)
ASL09 ... ASL16	

The addition of an overload relay on the contactor does not prevent fitting of many other accessories as shown above.

(1) Direct mounting - No kit required.

AS09 ... AS16 and ASL09 ... ASL16 3-pole contactors

Main accessories



CA3-10



TEF3-ON



VM3



RV5



BEA16-3



BER16C-3



BEY16C-3

Front-mounted instantaneous auxiliary contact blocks

For contactors	Auxiliary contacts	Type	Order code	Pkg qty	Weight (1 pce) kg
AS09 ... AS16	1 0	CA3-10	1SBN011010T1010	10	0.011
ASL09 ... ASL16	0 1	CA3-01	1SBN011010T1001	10	0.011

Front-mounted electronic timer

For contactors	Rated control circuit voltage - Uc V	Type	Order code	Pkg qty	Weight (1 pce) kg
ON-delay					
AS09 ... AS16, ASL09 ... ASL16	24...240 V AC/DC	TEF3-ON	1SBN021012R1000	1	0.065
OFF-delay					
AS09 ... AS16, ASL09 ... ASL16	24...240 V AC/DC	TEF3-OFF	1SBN021014R1000	1	0.065

Mechanical interlock unit

For contactors	Type	Order code	Pkg qty	Weight (1 pce) kg
AS09 ... AS16, ASL09 ... ASL16	VM3	1SBN031005T1000	10	0.002

Surge suppressors

For contactors	Rated control circuit voltage - Uc		Type	Order code	Pkg qty	Weight (1 pce) kg
	V	AC DC				
AS09 ... AS16, ASL09 ... ASL16	24...50	● ●	RV5/50	1SBN050010R1000	2	0.015
	50...133	● ●	RV5/133	1SBN050010R1001	2	0.015
	110...250	● ●	RV5/250	1SBN050010R1002	2	0.015
	250...440	● ●	RV5/440	1SBN050010R1003	2	0.015
AS09 ... AS16	24...50	● -	RC5-1/50	1SBN050100R1000	2	0.012
	50...133	● -	RC5-1/133	1SBN050100R1001	2	0.012
	110...250	● -	RC5-1/250	1SBN050100R1002	2	0.012
	250...440	● -	RC5-1/440	1SBN050100R1003	2	0.012
ASL09 ... ASL16	12...32	- ●	RT5/32	1SBN050020R1000	2	0.015
	25...65	- ●	RT5/65	1SBN050020R1001	2	0.015
	50...90	- ●	RT5/90	1SBN050020R1002	2	0.015
	77...150	- ●	RT5/150	1SBN050020R1003	2	0.015
	150...264	- ●	RT5/264	1SBN050020R1004	2	0.015

Connecting links with manual motor starters

For contactors	Manual motor starter	Type	Order code	Pkg qty	Weight (1 pce) kg
AS09 ... AS16	MS116-0.16 ... MS116-16	BEA16-3	1SBN081006T1000	10	0.019
ASL09 ... ASL16	MS132-0.16 ... MS132-16				

Connection sets for reversing contactors

For contactors	Mechanical interlock unit	Type	Order code	Pkg qty	Weight (1 pce) kg
AS09 ... AS16, ASL09 ... ASL16	with or without VM3	BER16C-3	1SBN081012R1000	1	0.035

Note: BER16C-3 connection set includes two BB3 fixing clips, and an electrical interlocking when fitted on contactors with built-in N.C. auxiliary contacts. BER16C-3 can be used with or without VM3 mechanical interlock unit.

Connection sets for star-delta starting

For contactors	Mech. interlock unit between Star & Delta contactors	Type	Order code	Pkg qty	Weight (1 pce) kg
AS09 ... AS12, ASL09 ... ASL12	with or without VM3	BEY16C-3	1SBN081018R2000	1	0.041

Note: BEY16C-3 connection set includes two BB3 fixing clips, and an electrical interlocking when fitted on Star and Delta contactors with built-in N.C. auxiliary contacts. BEY16C-3 can be used with or without VM3 mechanical interlock unit.

AS09 ... AS16 and ASL09 ... ASL16 3-pole contactors

Technical data

Main pole - Utilization characteristics according to IEC

Contactor types	AC operated	AS09	AS12	AS16
	DC operated	ASL09	ASL12	ASL16
Standards	IEC 60947-1 / 60947-4-1 and EN 60947-1 / 60947-4-1			
Rated operational voltage U_e max.	690 V			
Rated frequency (without derating)	50 / 60 Hz			
Conventional free-air thermal current I_{th}				
acc. to IEC 60947-4-1, open contactors, $\theta \leq 40\text{ °C}$		22 A	25 A	25 A
With conductor cross-sectional area		2.5 mm ²	4 mm ²	4 mm ²
AC-1 Utilization category				
For air temperature close to contactor				
I_e / Rated operational current AC-1	$\theta \leq 40\text{ °C}$	22 A	24 A	24 A
U _e max. $\leq 690\text{ V}$, 50/60 Hz	$\theta \leq 60\text{ °C}$	18 A	20 A	20 A
	$\theta \leq 70\text{ °C}$	15 A	16 A	16 A
With conductor cross-sectional area		2.5 mm ²		
AC-3 Utilization category				
For air temperature close to contactor $\theta \leq 60\text{ °C}$				
I_e / Max. rated operational current AC-3 (1)				
	220-230-240 V	9 A	12 A	15.7 A
	400 V	9 A	12 A	15.5 A
	415 V	9 A	12 A	15.5 A
	440 V	8 A	11 A	13.6 A
	500 V	8 A	11 A	12.5 A
	690 V	5 A	7 A	9 A
Rated operational power AC-3 (1)				
	220-230-240 V	2.2 kW	3 kW	4 kW
	400 V	4 kW	5.5 kW	7.5 kW
	415 V	4 kW	5.5 kW	7.5 kW
	440 V	4 kW	5.5 kW	7.5 kW
	500 V	4 kW	5.5 kW	7.5 kW
	690 V	4 kW	5.5 kW	7.5 kW
Rated making capacity AC-3	10 x I _e AC-3 acc. to IEC 60947-4-1			
Rated breaking capacity AC-3	8 x I _e AC-3 acc. to IEC 60947-4-1			
AC-8a Utilization category				
(without thermal overload relay - U _e 400 V 50/60 Hz - $\theta \leq 40\text{ °C}$)				
I_e / Rated operational current AC-8a		12 A	16 A	22 A
Rated operational power AC-8a		5.5 kW	7.5 kW	11 kW
Short-circuit protection device for contactors				
without thermal overload relay - Motor protection excluded (2)				
U _e $\leq 500\text{ V AC}$ - gG type fuse		25 A		
Rated short-time withstand current I_{cw}				
at 40 °C ambient temperature,	1 s	230 A	250 A	250 A
in free air from a cold state	10 s	100 A	124 A	124 A
	30 s	65 A	75 A	75 A
	1 min	50 A	55 A	55 A
	15 min	22 A	24 A	24 A
Maximum breaking capacity				
cos $\phi = 0.45$	at 440 V	155 A		
	at 690 V	90 A		
Power dissipation per pole				
	I _e / AC-1	1 W	1.2 W	1.2 W
	I _e / AC-3	0.16 W	0.3 W	0.5 W
Max. electrical switching frequency				
	AC-1	600 cycles/h		
	AC-3	1200 cycles/h		
	AC-4	300 cycles/h		

(1) For the corresponding kW/A or hp/A values of 1500 r.p.m., 50 Hz or 1800 r.p.m., 60 Hz, 3-phase motors, see "Motor rated operational powers and currents".

(2) For the protection of motor starters against short circuits, see "Coordination with short-circuit protection devices".

AS09 ... AS16 and ASL09 ... ASL16 3-pole contactors

Technical data

Main pole - Utilization characteristics according to UL / NEMA / CSA

Contactor types	AC operated	AS09	AS12	AS16	
	DC operated	ASL09	ASL12	ASL16	
Standards	UL 508, CSA C22.2 N°14				
Max. operational voltage	690 V				
NEMA size	00		00	0	
NEMA continuous amp rating	Thermal current	9 A	9 A	18 A	
NEMA maximum horse power ratings 1-phase, 60 Hz	115 V AC	1/3 hp	1/3 hp	1 hp	
	230 V AC	1 hp	1 hp	2 hp	
NEMA maximum horse power ratings 3-phase, 60 Hz	200 V AC	1 1/2 hp	1 1/2 hp	3 hp	
	230 V AC	1 1/2 hp	1 1/2 hp	3 hp	
	460 V AC	2 hp	2 hp	5 hp	
	575 V AC	2 hp	2 hp	5 hp	
UL / CSA general use rating	600 V AC	20 A	20 A	20 A	
	With conductor cross-sectional area	AWG 12	AWG 12	AWG 12	
UL / CSA maximum 1-phase motor rating	Full load current	120 V AC: 7.2 A 240 V AC: 8 A	9.8 A 10 A	13.8 A 12 A	
	Horse power rating	120 V AC: 1/3 hp 240 V AC: 1 hp	1/2 hp 1-1/2 hp	3/4 hp 2 hp	
	UL / CSA maximum 3-phase motor rating	Full load current (1)	200-208 V AC: 7.8 A 220-240 V AC: 6.8 A 440-480 V AC: 7.6 A 550-600 V AC: 9 A	7.8 A 9.6 A 11 A 11 A	11 A 15.2 A 14 A 11 A
		Horse power rating (1)	200-208 V AC: 2 hp 220-240 V AC: 2 hp 440-480 V AC: 5 hp 550-600 V AC: 7-1/2 hp	2 hp 3 hp 7-1/2 hp 10 hp	3 hp 5 hp 10 hp 10 hp
Short-circuit protection device for contactors					
without thermal overload relay - Motor protection excluded					
Fuse rating		40 A	50 A	60 A	
Fuse type, 600 V					
J					
Max. electrical switching frequency	For general use: 600 cycles/h				
	For motor use: 1200 cycles/h				

(1) For the corresponding kW/A or hp/A values of 1500 r.p.m, 50 Hz or 1800 r.p.m, 60 Hz, 3-phase motors, see "Motor rated operational powers and currents".

General technical data

Contactor types	AC operated	AS09	AS12	AS16
	DC operated	ASL09	ASL12	ASL16
Rated insulation voltage Ui	acc. to IEC 60947-4-1	690 V		
	acc. to UL / CSA	600 V		
Rated impulse withstand voltage Uimp.	6 kV			
Ambient air temperature close to contactor				
Operation	Fitted with thermal overload relay	-25...+60 °C		
	Without thermal overload relay	-40...+70 °C		
Storage	-60...+80 °C			
Climatic withstand	Category B according to IEC 60947-1 Annex Q			
Maximum operating altitude (without derating)	3000 m			
Mechanical durability				
Number of operating cycles	10 millions operating cycles			
Max. switching frequency	3600 cycles/h			
Shock withstand				
acc. to IEC 60068-2-27 and EN 60068-2-27				
Mounting position 1	Shock direction	AS contactors - AC operated		ASL contactors - DC operated
	A	20 g		20 g closed position / 10 g open position
	B1	10 g closed position / 5 g open position		15 g closed position / 5 g open position
	B2	15 g		10 g
	C1	20 g closed position / 9 g open position		15 g closed position / 8 g open position
	C2	20 g closed position / 14 g open position		14 g closed position / 8 g open position
Vibration withstand acc. to IEC 60068-2-6	5...300 Hz / 3 g closed position / 2 g open position			

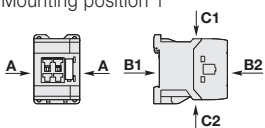

AS09 ... AS16 and ASL09 ... ASL16 3-pole contactors

Technical data

Magnet system characteristics for AS09 ... AS16 contactors

Contactor types	AC operated	AS09	AS12	AS16
Coil operating limits	AC supply	acc. to IEC 60947-4-1		
		0.85...1.1 x U _c (at $\theta \leq 60$ °C); U _c (at $\theta \leq 70$ °C)		
AC control voltage	Rated control circuit voltage U _c	at 50 Hz	24...415 V	
		at 60 Hz	24...415 V	
Coil consumption	Average pull-in value	50 Hz	33 VA	
		60 Hz	33 VA	
		50/60 Hz	33 VA	
	Average holding value	50 Hz	6.5 VA / 1.5 W	
		60 Hz	5 VA / 1.2 W	
		50/60 Hz	6.5 VA / 1.5 W	
Drop-out voltage		Approx. 30...50 % of U _c		
Operating time				
Between coil energization and:	N.O. contact closing	9...24 ms		
	N.C. contact opening	6...18 ms		
Between coil de-energization and:	N.O. contact opening (1)	5...19 ms		
	N.C. contact closing (1)	7...22 ms		
(1) The use of RC5-1 surge suppressor increases opening time by a factor of 2 to 3				

Magnet system characteristics for ASL09 ... ASL16 contactors

Contactor types	DC operated	ASL09	ASL12	ASL16
Coil operating limits	DC supply	acc. to IEC 60947-4-1		
		0.85...1.1 x U _c (at $\theta \leq 60$ °C); U _c (at $\theta \leq 70$ °C)		
DC control voltage	Rated control circuit voltage U _c	12...240 V DC		
Coil consumption	Average pull-in value	3 W		
	Average holding value	3 W		
Drop-out voltage		Approx. 10...40 % of U _c		
Coil time constant	Open	L/R	12 ms	
	Closed	L/R	40 ms	
Operating time				
Between coil energization and:	N.O. contact closing	36...59 ms		
	N.C. contact opening	31...53 ms		
Between coil de-energization and:	N.O. contact opening (1)	13...17 ms		
	N.C. contact closing (1)	15...20 ms		
(1) The use of RT5 surge suppressor increases opening time by a factor of 1.1 to 1.2				

















Mounting characteristics and conditions for use

Contactor types	AC operated	AS09	AS12	AS16
	DC operated	ASL09	ASL12	ASL16
Mounting positions				
Mounting distances	The contactors can be assembled side by side.			
Fixing	On rail according to IEC 60715, EN 60715	35 x 7.5 mm or 35 x 15 mm		
	By screws (not supplied)	2 x M4 screws placed diagonally		

AS09 ... AS16 and ASL09 ... ASL16 3-pole contactors

Technical data

Connecting characteristics

Contactor types	AC operated	AS09	AS12	AS16
	DC operated	ASL09	ASL12	ASL16
Main terminals				
	Screw terminals with cable clamp			
Connection capacity (min. ... max.)				
Main conductors (poles)				
	Rigid solid	1 x	0.75...4 mm ²	
	Flexible with non insulated ferrule	2 x	0.75...4 mm ²	
		1 x	0.75...2.5 mm ²	
	Flexible with insulated ferrule	2 x	0.75...2.5 mm ²	
		1 x	0.75...2.5 mm ²	
	Flexible with insulated ferrule	2 x	0.75...1.5 mm ²	
		1 x	0.75...2.5 mm ²	
	Bars or lugs	L ≤	7.7 mm	
		L >	3.2 mm	
Connection capacity acc. to UL / CSA		1 or 2 x	AWG 18...12	
Stripping length			9 mm	
Tightening torque	Recommended		1.00 Nm / 9 lb.in	
	Max.		1.20 Nm	
Auxiliary conductors				
(built-in auxiliary terminals + coil terminals)				
	Rigid solid	1 x	0.75...2.5 mm ²	
	Flexible with non insulated ferrule	2 x	0.75...2.5 mm ²	
		1 x	0.75...2.5 mm ²	
	Flexible with insulated ferrule	2 x	0.75...2.5 mm ²	
		1 x	0.75...2.5 mm ²	
	Flexible with insulated ferrule	2 x	0.75...1.5 mm ²	
		1 x	0.75...2.5 mm ²	
	Lugs	L ≤	7.7 mm	
		L >	3.2 mm	
Connection capacity acc. to UL / CSA		1 or 2 x	AWG 18...14	
Stripping length			9 mm	
Tightening torque	Coil terminals	Recommended	1.00 Nm / 9 lb.in	
		Max.	1.20 Nm	
Tightening torque	Built-in auxiliary terminals	Recommended	1.00 Nm / 9 lb.in	
		Max.	1.20 Nm	
Degree of protection				
acc. to IEC 60947-1 / EN 60947-1 and IEC 60529 / EN 60529				
All terminals				
IP20				
Screw terminals				
All terminals				
Delivered in open position, screws of unused terminals must be tightened				
M3				
Screwdriver type				
Flat Ø 5.5 / Pozidriv 2				

AS09 ... AS16 and ASL09 ... ASL16 3-pole contactors

Technical data

Built-in auxiliary contacts according to IEC

Contactor types	AC operated	AS09	AS12	AS16
	DC operated	ASL09	ASL12	ASL16
Rated operational voltage U _e max.		690 V		
Rated frequency (without derating)		50 / 60 Hz		
Conventional free-air thermal current I _{th} - θ ≤ 40 °C		10 A		
I _e / Rated operational current AC-15		6 A		
acc. to IEC 60947-5-1	24-127 V 50/60 Hz	4 A		
	220-240 V 50/60 Hz	3 A		
	400-440 V 50/60 Hz	2 A		
	500 V 50/60 Hz	2 A		
	690 V 50/60 Hz	2 A		
Making capacity AC-15		10 x I _e AC-15 acc. to IEC 60947-5-1		
Breaking capacity AC-15		10 x I _e AC-15 acc. to IEC 60947-5-1		
I _e / Rated operational current DC-13		6 A / 144 W		
acc. to IEC 60947-5-1	24 V DC	2.8 A / 134 W		
	48 V DC	1 A / 72 W		
	72 V DC	0.55 A / 60 W		
	110 V DC	0.55 A / 69 W		
	125 V DC	0.27 A / 60 W		
	220 V DC	0.27 A / 68 W		
	250 V DC	10 A		
Short-circuit protection device gG type fuse		100 A		
Rated short-time withstand current I _{cw}	for 1.0 s	140 A		
	for 0.1 s	12 V / 3 mA		
Minimum switching capacity		10 ⁻⁷		
with failure rate acc. to IEC 60947-5-4		1.5 ms		
Non-overlapping time between N.O. and N.C. contacts		0.1 W		
Power dissipation per pole at 6 A		AC-15 1200 cycles/h		
Max. electrical switching frequency	DC-13	900 cycles/h		
Mechanically linked contacts		Built-in N.O. or N.C. auxiliary contacts and additional N.O. or N.C. auxiliary contacts (CA3 aux. contact blocks) are mechanically linked contacts.		
acc. to annex L of IEC 60947-5-1		Built-in N.C. auxiliary contacts or additional N.C. auxiliary contacts (CA3 aux. contact blocks) are mirror contacts.		
Mirror contacts		acc. to annex F of IEC 60947-4-1		

Built-in auxiliary contacts according to UL / CSA

Contactor types	AC operated	AS09	AS12	AS16
	DC operated	ASL09	ASL12	ASL16
Max. operational voltage		600 V AC, 250 V DC		
Pilot duty		A600, Q300		
AC thermal rated current		10 A		
AC maximum volt-ampere making		7200 VA		
AC maximum volt-ampere breaking		720 VA		
DC thermal rated current		2.5 A		
DC maximum volt-ampere making-breaking		69 VA		

Notes

A series of horizontal dotted lines for taking notes.

VAS09 ... VAS16 3-pole reversing contactors

4 to 7.5 kW

AC operated

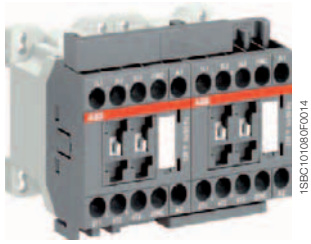

VAS09EM

Description

VAS09 ... VAS16 reversing contactors are used for controlling 3-phase motors up to 690 V AC. These reversing contactors include 2 AS09 ... AS16 contactors fitted with 1 N.C. auxiliary contact, 1 VM3 mechanical interlock and BER16C-3 reversing connection set including electrical interlocking. Up to 2 add-on CA3 1-pole auxiliary contact blocks can be mounted per contactor.

The reversing contactors are available with or without surge suppressor mounted on each contactor.

Ordering details

IEC Rated operational power	UL/CSA 3-phase motor rating 480 V	Rated control circuit voltage Uc (1)		Auxiliary contacts fitted	Type	Order code	Pkg qty	Weight (1 pce)
400 V AC-3 kW	hp	V 50 Hz	V 60 Hz					kg

Reversing contactors without integrated surge suppressor

4	5	24	24	0	2	VAS09EM-20M	1SBK103600M2000	18	0.480
		-	120	0	2	VAS09EM-16M	1SBK103600M1600	18	0.480
		230	230	0	2	VAS09EM-26M	1SBK103600M2600	18	0.480
		400	400	0	2	VAS09EM-28M	1SBK103600M2800	18	0.480
5.5	7.5	24	24	0	2	VAS12EM-20M	1SBK113600M2000	18	0.480
		-	120	0	2	VAS12EM-16M	1SBK113600M1600	18	0.480
		230	230	0	2	VAS12EM-26M	1SBK113600M2600	18	0.480
		400	400	0	2	VAS12EM-28M	1SBK113600M2800	18	0.480
7.5	10	24	24	0	2	VAS16EM-20M	1SBK123600M2000	18	0.480
		-	120	0	2	VAS16EM-16M	1SBK123600M1600	18	0.480
		230	230	0	2	VAS16EM-26M	1SBK123600M2600	18	0.480
		400	400	0	2	VAS16EM-28M	1SBK123600M2800	18	0.480

Reversing contactors with RC5-1 integrated surge suppressor

4	5	24	24	0	2	VAS09SEM-20M	1SBK103800M2000	18	0.510
		-	120	0	2	VAS09SEM-16M	1SBK103800M1600	18	0.510
		230	230	0	2	VAS09SEM-26M	1SBK103800M2600	18	0.510
		400	400	0	2	VAS09SEM-28M	1SBK103800M2800	18	0.510
5.5	7.5	24	24	0	2	VAS12SEM-20M	1SBK113800M2000	18	0.510
		-	120	0	2	VAS12SEM-16M	1SBK113800M1600	18	0.510
		230	230	0	2	VAS12SEM-26M	1SBK113800M2600	18	0.510
		400	400	0	2	VAS12SEM-28M	1SBK113800M2800	18	0.510
7.5	10	24	24	0	2	VAS16SEM-20M	1SBK123800M2000	18	0.510
		-	120	0	2	VAS16SEM-16M	1SBK123800M1600	18	0.510
		230	230	0	2	VAS16SEM-26M	1SBK123800M2600	18	0.510
		400	400	0	2	VAS16SEM-28M	1SBK123800M2800	18	0.510

(1) Other control voltages see voltage code table.

Note: Minimum switchover delay of 50 ms must be introduced between respective opening and closing of AC operated reversing contactors.

Main dimensions mm, inches

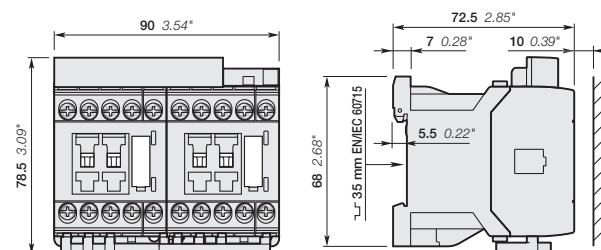

VAS09, VAS12, VAS16

VASL09 ... VASL16 3-pole reversing contactors

4 to 7.5 kW

DC operated



VASL09EM

Description

VASL09 ... VASL16 reversing contactors are used for controlling 3-phase motors up to 690 V AC. These reversing contactors include 2 ASL09 ... ASL16 contactors fitted with 1 N.C. auxiliary contact, 1 VM3 mechanical interlock and BER16C-3 reversing connection set including electrical interlocking. Up to 2 add-on CA3 1-pole auxiliary contact blocks can be mounted per contactor.

The reversing contactors are available with or without surge suppressor mounted on each contactor.

Ordering details

IEC Rated operational power	UL/CSA 3-phase motor rating 480 V	Rated control circuit voltage Uc (1)	Auxiliary contacts fitted	Type	Order code	Pkg qty	Weight (1 pce)
400 V AC-3 kW	hp	V DC					kg

Reversing contactors without integrated surge suppressor

4	5	24	0 2	VASL09EM-81M	1SBK103700M8100	18	0.600
		48	0 2	VASL09EM-83M	1SBK103700M8300	18	0.600
		110	0 2	VASL09EM-86M	1SBK103700M8600	18	0.600
		220	0 2	VASL09EM-88M	1SBK103700M8800	18	0.600
5.5	7.5	24	0 2	VASL12EM-81M	1SBK113700M8100	18	0.600
		48	0 2	VASL12EM-83M	1SBK113700M8300	18	0.600
		110	0 2	VASL12EM-86M	1SBK113700M8600	18	0.600
		220	0 2	VASL12EM-88M	1SBK113700M8800	18	0.600
7.5	10	24	0 2	VASL16EM-81M	1SBK123700M8100	18	0.600
		48	0 2	VASL16EM-83M	1SBK123700M8300	18	0.600
		110	0 2	VASL16EM-86M	1SBK123700M8600	18	0.600
		220	0 2	VASL16EM-88M	1SBK123700M8800	18	0.600

Reversing contactors with RV5 integrated surge suppressor

4	5	24	0 2	VASL09SEM-81M	1SBK103900M8100	18	0.630
		48	0 2	VASL09SEM-83M	1SBK103900M8300	18	0.630
		110	0 2	VASL09SEM-86M	1SBK103900M8600	18	0.630
		220	0 2	VASL09SEM-88M	1SBK103900M8800	18	0.630
5.5	7.5	24	0 2	VASL12SEM-81M	1SBK113900M8100	18	0.630
		48	0 2	VASL12SEM-83M	1SBK113900M8300	18	0.630
		110	0 2	VASL12SEM-86M	1SBK113900M8600	18	0.630
		220	0 2	VASL12SEM-88M	1SBK113900M8800	18	0.630
7.5	10	24	0 2	VASL16SEM-81M	1SBK123900M8100	18	0.630
		48	0 2	VASL16SEM-83M	1SBK123900M8300	18	0.630
		110	0 2	VASL16SEM-86M	1SBK123900M8600	18	0.630
		220	0 2	VASL16SEM-88M	1SBK123900M8800	18	0.630

(1) Other control voltages see voltage code table.

Main dimensions mm, inches

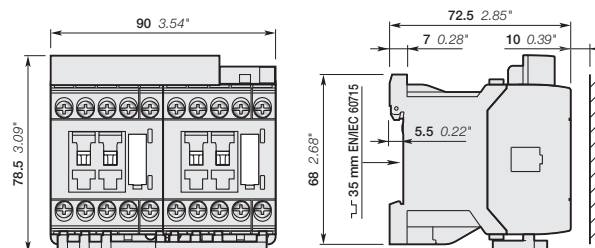

VASL09, VASL12, VASL16

VAS09 ... VAS16 and VASL09 ... VASL16 3-pole reversing contactors

Technical data

Main pole - Utilization characteristics according to IEC

Contractor types	AC operated	VAS09	VAS12	VAS16
	DC operated	VASL09	VASL12	VASL16
Standards		IEC 60947-1 / 60947-4-1 and EN 60947-1 / 60947-4-1		
Rated operational voltage U_e max.		690 V		
Rated frequency (without derating)		50 / 60 Hz		
Conventional free-air thermal current I_{th}				
acc. to IEC 60947-4-1, open contactors, $\theta \leq 40$ °C		22 A	25 A	25 A
With conductor cross-sectional area		2.5 mm ²	4 mm ²	4 mm ²
AC-3 Utilization category				
For air temperature close to contactor $\theta \leq 60$ °C				
I_e / Max. rated operational current AC-3 (1)				
	220-230-240 V	9 A	12 A	15.7 A
	400 V	9 A	12 A	15.5 A
	415 V	9 A	12 A	15.5 A
	440 V	8 A	11 A	13.6 A
	500 V	8 A	11 A	12.5 A
	690 V	5 A	7 A	9 A
Rated operational power AC-3 (1)				
	220-230-240 V	2.2 kW	3 kW	4 kW
	400 V	4 kW	5.5 kW	7.5 kW
	415 V	4 kW	5.5 kW	7.5 kW
	440 V	4 kW	5.5 kW	7.5 kW
	500 V	4 kW	5.5 kW	7.5 kW
	690 V	4 kW	5.5 kW	7.5 kW
Rated making capacity AC-3		10 x I _e AC-3 acc. to IEC 60947-4-1		
Rated breaking capacity AC-3		8 x I _e AC-3 acc. to IEC 60947-4-1		
Short-circuit protection device for contactors				
without thermal overload relay - Motor protection excluded (2)				
U _e ≤ 500 V AC - gG type fuse		25 A		
Rated short-time withstand current I_{cw}				
at 40 °C ambient temperature,	1 s	230 A	250 A	250 A
in free air from a cold state	10 s	100 A	124 A	124 A
	30 s	65 A	75 A	75 A
	1 min	50 A	55 A	55 A
	15 min	22 A	24 A	24 A
Maximum breaking capacity				
cos ϕ = 0.45	at 440 V	155 A		
	at 690 V	90 A		
Power dissipation per pole				
	I_e / AC-3	0.16 W	0.3 W	0.5 W
Max. electrical switching frequency	AC-3	600 cycles/h		



3-phase motors



1500 r.p.m. 50 Hz
1800 r.p.m. 60 Hz
3-phase motors

(1) For the corresponding kW/A or hp/A values of 1500 r.p.m, 50 Hz or 1800 r.p.m, 60 Hz, 3-phase motors, see "Motor rated operational powers and currents".

(2) For the protection of motor starters against short circuits, see "Coordination with short-circuit protection devices".

VAS09 ... VAS16 and VASL09 ... VASL16 3-pole reversing contactors

Technical data

Main pole - Utilization characteristics according to UL / NEMA / CSA

Contactor types	AC operated	VAS09	VAS12	VAS16
	DC operated	VASL09	VASL12	VASL16
Standards	UL 508, CSA C22.2 N°14			
Max. operational voltage	690 V			
NEMA size	00		00	0
NEMA continuous amp rating	Thermal current	9 A	9 A	18 A
NEMA maximum horse power ratings 1-phase, 60 Hz	115 V AC	1/3 hp	1/3 hp	1 hp
	230 V AC	1 hp	1 hp	2 hp
NEMA maximum horse power ratings 3-phase, 60 Hz	200 V AC	1 1/2 hp	1 1/2 hp	3 hp
	230 V AC	1 1/2 hp	1 1/2 hp	3 hp
	460 V AC	2 hp	2 hp	5 hp
	575 V AC	2 hp	2 hp	5 hp
UL / CSA maximum 1-phase motor rating	Full load current			
	120 V AC	7.2 A	9.8 A	13.8 A
	240 V AC	8 A	10 A	12 A
	Horse power rating			
120 V AC	1/3 hp	1/2 hp	3/4 hp	
240 V AC	1 hp	1-1/2 hp	2 hp	
UL / CSA maximum 3-phase motor rating	Full load current (1)			
	200-208 V AC	7.8 A	7.8 A	11 A
	220-240 V AC	6.8 A	9.6 A	15.2 A
	440-480 V AC	7.6 A	11 A	14 A
	550-600 V AC	9 A	11 A	11 A
	Horse power rating (1)			
	200-208 V AC	2 hp	2 hp	3 hp
	220-240 V AC	2 hp	3 hp	5 hp
440-480 V AC	5 hp	7-1/2 hp	10 hp	
550-600 V AC	7-1/2 hp	10 hp	10 hp	
Short-circuit protection device for contactors				
without thermal overload relay - Motor protection excluded				
Fuse rating		40 A	50 A	60 A
Fuse type, 600 V		J		
Max. electrical switching frequency				
For motor use		600 cycles/h		

(1) For the corresponding kW/A or hp/A values of 1500 r.p.m, 50 Hz or 1800 r.p.m, 60 Hz, 3-phase motors, see "Motor rated operational powers and currents".

General technical data

Contactor types	AC operated	VAS09	VAS12	VAS16
	DC operated	VASL09	VASL12	VASL16
Rated insulation voltage Ui				
acc. to IEC 60947-4-1		690 V		
acc. to UL / CSA		600 V		
Rated impulse withstand voltage Uimp.		6 kV		
Ambient air temperature close to contactor				
Operation	Fitted with thermal overload relay	-25...+60 °C		
	Without thermal overload relay	-40...+70 °C		
Storage		-60...+80 °C		
Climatic withstand		Category B according to IEC 60947-1 Annex Q		
Maximum operating altitude (without derating)		3000 m		
Mechanical durability				
Number of operating cycles		5 millions operating cycles		
Max. switching frequency		1800 cycles/h		

VAS09 ... VAS16 and VASL09 ... VASL16 3-pole reversing contactors

Technical data

Magnet system characteristics for VAS09 ... VAS16 contactors

Contactor types	AC operated	VAS09	VAS12	VAS16
Coil operating limits acc. to IEC 60947-4-1	AC supply	0.85...1.1 x U _c (at $\theta \leq 60$ °C); U _c (at $\theta \leq 70$ °C)		
AC control voltage	Rated control circuit voltage U _c	at 50 Hz	24...415 V	
		at 60 Hz	24...415 V	
Coil consumption	Average pull-in value	50 Hz	33 VA	
		60 Hz	33 VA	
		50/60 Hz	33 VA	
	Average holding value	50 Hz	6.5 VA / 1.5 W	
		60 Hz	5 VA / 1.2 W	
50/60 Hz		6.5 VA / 1.5 W		
Drop-out voltage		Approx. 30...50 % of U _c		
Operating time				
Between coil energization and:	N.O. contact closing	9...24 ms		
	N.C. contact opening	6...18 ms		
Between coil de-energization and:	N.O. contact opening (1)	5...19 ms		
	N.C. contact closing (1)	7...22 ms		
(1) The use of RC5-1 surge suppressor increases opening time by a factor of 2 to 3.				

Magnet system characteristics for VASL09 ... VASL16 contactors

Contactor types	DC operated	VASL09	VASL12	VASL16	
Coil operating limits acc. to IEC 60947-4-1	DC supply	0.85...1.1 x U _c (at $\theta \leq 60$ °C); U _c (at $\theta \leq 70$ °C)			
DC control voltage	Rated control circuit voltage U _c	12...240 V DC			
		Average pull-in value	3 W		
		Average holding value	3 W		
Drop-out voltage		Approx. 10...40 % of U _c			
Coil time constant	Open	L/R	12 ms		
	Closed	L/R	40 ms		
Operating time					
Between coil energization and:	N.O. contact closing	36...59 ms			
	N.C. contact opening	31...53 ms			
Between coil de-energization and:	N.O. contact opening (1)	13...17 ms			
	N.C. contact closing (1)	15...20 ms			
(1) The use of RT5 surge suppressor increases opening time by a factor of 1.1 to 1.2					







Mounting characteristics and conditions for use

Contactor types	AC operated	VAS09	VAS12	VAS16
	DC operated	VASL09	VASL12	VASL16
Mounting positions				
Mounting distances	The reversing contactors can be assembled side by side.			
Fixing	On rail according to IEC 60715, EN 60715	35 x 7.5 mm or 35 x 15 mm		
	By screws (not supplied)	2 x M4 screws placed diagonally		

VAS09 ... VAS16 and VASL09 ... VASL16 3-pole reversing contactors

Technical data

Connecting characteristics

Contactor types	AC operated	VAS09	VAS12	VAS16
	DC operated	VASL09	VASL12	VASL16
Main terminals	 Screw terminals with cable clamp			
Connection capacity (min. ... max.)				
Main conductors (poles)				
	Rigid solid	1 x	0.75...4 mm ²	
	Flexible with non insulated ferrule	1 x	0.75...2.5 mm ²	
	Flexible with insulated ferrule	1 x	0.75...1.5 mm ²	
	Connection capacity acc. to UL / CSA	1 x	AWG 18...12	
	Stripping length		9 mm	
	Tightening torque		Recommended	
			1.00 Nm / 9 lb.in	
			Max.	
			1.20 Nm	
Auxiliary conductors				
(built-in auxiliary terminals + coil terminals)				
	Rigid solid	1 x	0.75...2.5 mm ²	
	Flexible with non insulated ferrule	1 x	0.75...2.5 mm ²	
	Flexible with insulated ferrule	1 x	0.75...1.5 mm ²	
	Connection capacity acc. to UL / CSA	1 x	AWG 18...14	
	Stripping length		9 mm	
	Tightening torque		Recommended	
	Coil terminals		1.00 Nm / 9 lb.in	
			Max.	
			1.20 Nm	
	Built-in auxiliary terminals		Recommended	
			1.00 Nm / 9 lb.in	
			Max.	
			1.20 Nm	
Degree of protection				
acc. to IEC 60947-1 / EN 60947-1 and IEC 60529 / EN 60529				
	All terminals		IP20	
Screw terminals				
	All terminals		Delivered in open position, screws of unused terminals must be tightened	
			M3	
	Screwdriver type		Flat Ø 5.5 / Pozidriv 2	

Contactor relays

Main accessories

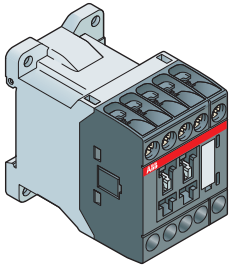

NS, NSL
Contactor relays

4

4-pole contactor relays

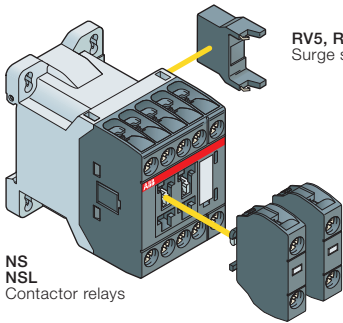

RV5, RT5 or RC5-1
Surge suppressor

CA-3
1-pole auxiliary contact block

**NS
NSL**
Contactor relays

8-pole contactor relays

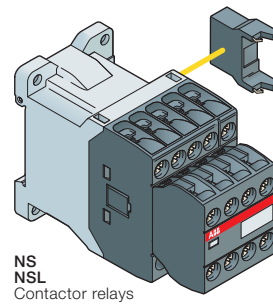

RV5, RT5 or RC5-1
Surge suppressor

**NS
NSL**
Contactor relays

Contactors relays



Screw terminals



NS



NSL

	AC control voltage	NS22E	NS31E	NS40E
	DC control voltage	NSL22E	NSL31E	NSL40E
		2 N.O. + 2 N.C.	3 N.O. + 1 N.C.	4 N.O.

4



NS



NSL

	AC control voltage	NS44E	NS53E	NS62E	NS71E	NS80E
	DC control voltage	NSL44E	NSL53E	NSL62E	NSL71E	NSL80E
		4 N.O. + 4 N.C.	5 N.O. + 3 N.C.	6 N.O. + 2 N.C.	7 N.O. + 1 N.C.	8 N.O.

Control circuit switching

	Rated operational current		
IEC	AC-15	240 V	4 A
		400 V	3 A
		690 V	2 A
	DC-13	24 V	6 A / 144 W
		250 V	0.27 A / 68 W
UL / CSA	Pilot Duty	A600, Q300	

Main accessories

Auxiliary contact blocks	Front mounting		1-pole CA3-10 or CA3-01
Surge suppressors	Side-mounted (without additional width)		RV5 (Varistor) AC / DC
			RC5-1 (Capacitor) AC
			RT5 (Transil diode) DC

18EBC101409S0201

NS contactor relays

AC operated



NS22E

1SBG101012F0014

Description

NS contactor relays are used for switching auxiliary and control circuits.

These contactor relays are designed with:

- 4 poles or 8 poles. Contactor relays have mechanically linked auxiliary contact elements (side-marked symbol)
- control circuit: AC operated
- add-on auxiliary contact blocks for front mounting and a comprehensive range of accessories.

Ordering details

Number of contacts 1st stack	2nd stack	Rated control circuit voltage Uc (1)		Type	Order code	Weight Pkg (1 pce) kg
		V 50 Hz	V 60 Hz			
		24	24	NS22E-20	1SBH101001R2022	0.220
		-	120	NS22E-16	1SBH101001R1622	0.220
		230	230	NS22E-26	1SBH101001R2622	0.220
		400	400	NS22E-28	1SBH101001R2822	0.220
		24	24	NS31E-20	1SBH101001R2031	0.220
		-	120	NS31E-16	1SBH101001R1631	0.220
		230	230	NS31E-26	1SBH101001R2631	0.220
		400	400	NS31E-28	1SBH101001R2831	0.220
		24	24	NS40E-20	1SBH101001R2040	0.220
		-	120	NS40E-16	1SBH101001R1640	0.220
		230	230	NS40E-26	1SBH101001R2640	0.220
		400	400	NS40E-28	1SBH101001R2840	0.220
		24	24	NS44E-20	1SBH101001R2044	0.260
		-	120	NS44E-16	1SBH101001R1644	0.260
		230	230	NS44E-26	1SBH101001R2644	0.260
		400	400	NS44E-28	1SBH101001R2844	0.260
		24	24	NS53E-20	1SBH101001R2053	0.260
		-	120	NS53E-16	1SBH101001R1653	0.260
		230	230	NS53E-26	1SBH101001R2653	0.260
		400	400	NS53E-28	1SBH101001R2853	0.260
		24	24	NS62E-20	1SBH101001R2062	0.260
		-	120	NS62E-16	1SBH101001R1662	0.260
		230	230	NS62E-26	1SBH101001R2662	0.260
		400	400	NS62E-28	1SBH101001R2862	0.260
		24	24	NS71E-20	1SBH101001R2071	0.260
		-	120	NS71E-16	1SBH101001R1671	0.260
		230	230	NS71E-26	1SBH101001R2671	0.260
		400	400	NS71E-28	1SBH101001R2871	0.260
		24	24	NS80E-20	1SBH101001R2080	0.260
		-	120	NS80E-16	1SBH101001R1680	0.260
		230	230	NS80E-26	1SBH101001R2680	0.260
		400	400	NS80E-28	1SBH101001R2880	0.260

Note: for multiple packaging, please contact your ABB local sales organization.

(1) Other control voltages see voltage code table.

Main dimensions mm, inches

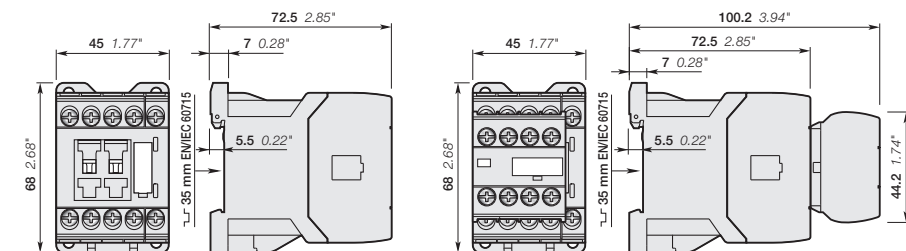

NS22E, NS31E, NS40E

NS44E, NS53E, NS62E, NS71E, NS80E

1SBG101475S0201

NSL contactor relays

DC operated



NSL22E

Description

NSL contactor relays are used for switching auxiliary and control circuits.

These contactor relays are designed with:

- 4 poles or 8 poles. Contactor relays have mechanically linked auxiliary contact elements (side-marked symbol)
- control circuit: low coil consumption (3 W at pull-in and holding) DC operated with solid core magnet. Suitable for direct control by PLC outputs (the polarity on the coil terminals A1+ and A2- must be respected)
- add-on auxiliary contact blocks for front mounting and a comprehensive range of accessories.

Ordering details

Number of contacts 1st stack	2nd stack	Rated control circuit voltage U _c (1) V DC	Type	Order code	Weight
					Pkg (1 pce) kg
		24	NSL22E-81	1SBH103001R8122	0.280
		48	NSL22E-83	1SBH103001R8322	0.280
		110	NSL22E-86	1SBH103001R8622	0.280
		220	NSL22E-88	1SBH103001R8822	0.280
		24	NSL31E-81	1SBH103001R8131	0.280
		48	NSL31E-83	1SBH103001R8331	0.280
		110	NSL31E-86	1SBH103001R8631	0.280
		220	NSL31E-88	1SBH103001R8831	0.280
		24	NSL40E-81	1SBH103001R8140	0.280
		48	NSL40E-83	1SBH103001R8340	0.280
		110	NSL40E-86	1SBH103001R8640	0.280
		220	NSL40E-88	1SBH103001R8840	0.280
		24	NSL44E-81	1SBH103001R8144	0.320
		48	NSL44E-83	1SBH103001R8344	0.320
		110	NSL44E-86	1SBH103001R8644	0.320
		220	NSL44E-88	1SBH103001R8844	0.320
		24	NSL53E-81	1SBH103001R8153	0.320
		48	NSL53E-83	1SBH103001R8353	0.320
		110	NSL53E-86	1SBH103001R8653	0.320
		220	NSL53E-88	1SBH103001R8853	0.320
		24	NSL62E-81	1SBH103001R8162	0.320
		48	NSL62E-83	1SBH103001R8362	0.320
		110	NSL62E-86	1SBH103001R8662	0.320
		220	NSL62E-88	1SBH103001R8862	0.320
		24	NSL71E-81	1SBH103001R8171	0.320
		48	NSL71E-83	1SBH103001R8371	0.320
		110	NSL71E-86	1SBH103001R8671	0.320
		220	NSL71E-88	1SBH103001R8871	0.320
		24	NSL80E-81	1SBH103001R8180	0.320
		48	NSL80E-83	1SBH103001R8380	0.320
		110	NSL80E-86	1SBH103001R8680	0.320
		220	NSL80E-88	1SBH103001R8880	0.320

Note: for multiple packaging, please contact your ABB local sales organization.

(1) Other control voltages see voltage code table.

Main dimensions mm, inches

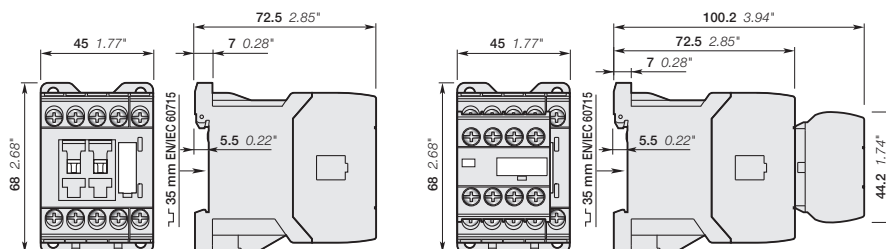

NSL22E, NSL31E, NSL40E

NSL44E, NSL53E, NSL62E, NSL71E, NSL80E

NS and NSL contactor relays

Main accessories

Contactor relays and main accessories (other accessories available)

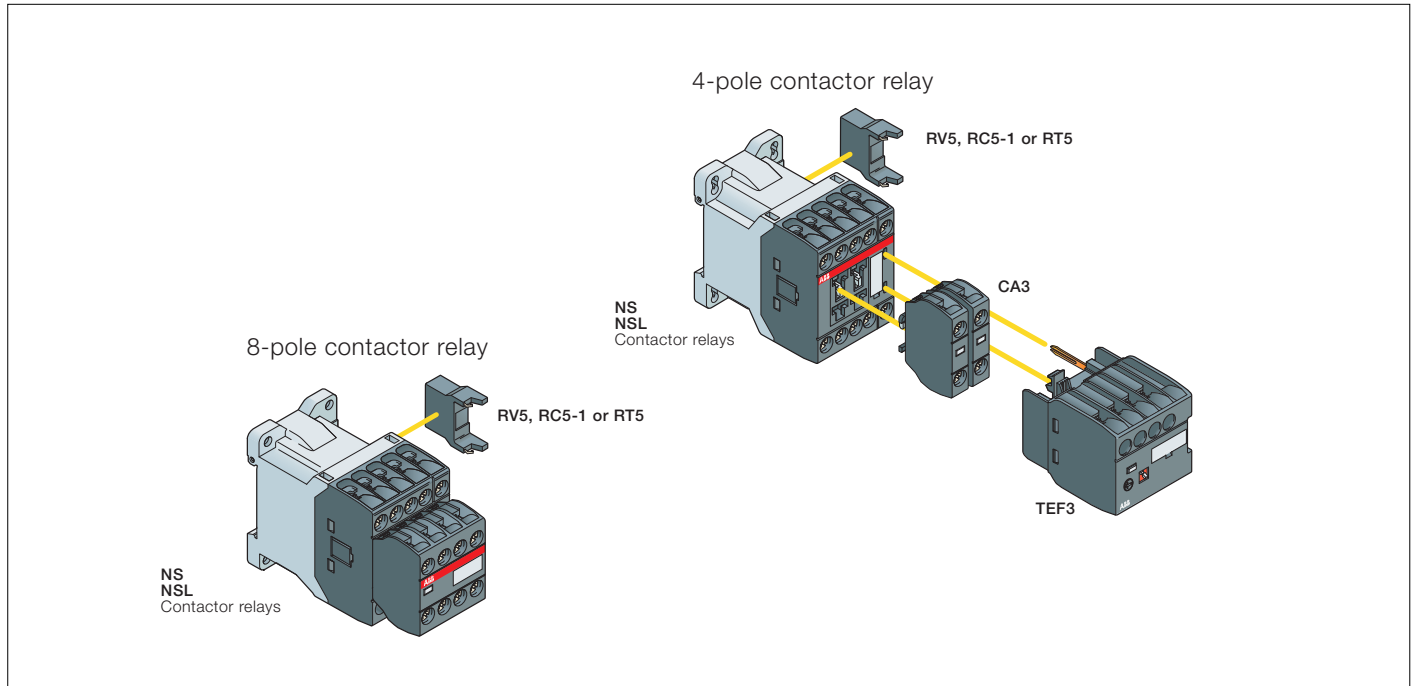

Main accessory fitting details

Contactor types	Main poles	Front-mounted accessories		Side-mounted accessories	
		Auxiliary contact blocks	Electronic timer	Surge suppressors	
		1-pole CA3	TEF3		
NS..	2 2 E	2 max.	or 1	+	RV5 or RC5-1
NS..	3 1 E				
NS..	4 0 E				
NS..	4 4 E	-	-		RV5 or RC5-1
NS..	5 3 E				
NS..	6 2 E				
NS..	7 1 E				
NS..	8 0 E				
NSL..	2 2 E	2 max.	or 1	+	RV5 or RT5
NSL..	3 1 E				
NSL..	4 0 E				
NSL..	4 4 E	-	-		RV5 or RT5
NSL..	5 3 E				
NSL..	6 2 E				
NSL..	7 1 E				
NSL..	8 0 E				

NS and NSL contactor relays

Main accessories



CA3-10

1SBC10103BF0014



TEF3-ON



1SBC101337F0014



RV5

1SBC574001F0301

Front-mounted instantaneous auxiliary contact blocks

For contactor relays	Auxiliary contacts	Type	Order code	Pkg qty	Weight (1 pce)
	 				kg
NS, NSL	1 0	CA3-10	1SBN011010T1010	10	0.011
	0 1	CA3-01	1SBN011010T1001	10	0.011

Front-mounted electronic timer

For contactors	Rated control circuit voltage - Uc	Type	Order code	Pkg qty	Weight (1 pce)
	V				kg
ON-delay					
NS, NSL	24...240 V AC/DC	TEF3-ON	1SBN021012R1000	1	0.065
OFF-delay					
NS, NSL	24...240 V AC/DC	TEF3-OFF	1SBN021014R1000	1	0.065

Surge suppressors

For contactor relays	Rated control circuit voltage - Uc		Type	Order code	Pkg qty	Weight (1 pce)
	V	AC DC				
NS, NSL	24...50	● ●	RV5/50	1SBN050010R1000	2	0.015
	50...133	● ●	RV5/133	1SBN050010R1001	2	0.015
	110...250	● ●	RV5/250	1SBN050010R1002	2	0.015
	250...440	● ●	RV5/440	1SBN050010R1003	2	0.015
NS	24...50	● -	RC5-1/50	1SBN050100R1000	2	0.012
	50...133	● -	RC5-1/133	1SBN050100R1001	2	0.012
	110...250	● -	RC5-1/250	1SBN050100R1002	2	0.012
	250...440	● -	RC5-1/440	1SBN050100R1003	2	0.012
NSL	12...32	- ●	RT5/32	1SBN050020R1000	2	0.015
	25...65	- ●	RT5/65	1SBN050020R1001	2	0.015
	50...90	- ●	RT5/90	1SBN050020R1002	2	0.015
	77...150	- ●	RT5/150	1SBN050020R1003	2	0.015
	150...264	- ●	RT5/264	1SBN050020R1004	2	0.015

NS and NSL contactor relays

Technical data

Contact utilization characteristics according to IEC

Contactor relay types	AC operated	NS
	DC operated	NSL
Standards	IEC 60947-5-1 and EN 60947-5-1	
Rated operational voltage U _e max.	690 V	
Rated frequency (without derating)	50 / 60 Hz	
Conventional free-air thermal current I _{th} - θ ≤ 40 °C	10 A	
I _e / Rated operational current AC-15 acc. to IEC 60947-5-1	24-127 V 50/60 Hz	6 A
	220-240 V 50/60 Hz	4 A
	400-440 V 50/60 Hz	3 A
	500 V 50/60 Hz	2 A
	690 V 50/60 Hz	2 A
Making capacity AC-15	10 x I _e AC-15 acc. to IEC 60947-5-1	
Breaking capacity AC-15	10 x I _e AC-15 acc. to IEC 60947-5-1	
I _e / Rated operational current DC-13 acc. to IEC 60947-5-1	24 V DC	6 A / 144 W
	48 V DC	2.8 A / 134 W
	72 V DC	1 A / 72 W
	110 V DC	0.55 A / 60 W
	125 V DC	0.55 A / 69 W
	220 V DC	0.27 A / 60 W
	250 V DC	0.27 A / 68 W
Short-circuit protection device for contactors U _e ≤ 500 V AC - gG type fuse	10 A	
Rated short-time withstand current I _{cw}	for 1.0 s	100 A
	for 0.1 s	140 A
Minimum switching capacity with failure rate acc. to IEC 60947-5-4	12 V / 3 mA 10 ⁷	
Non-overlapping time between N.O. and N.C. contacts	1.5 ms	
Power dissipation per pole at 6 A	0.1 W	
Max. electrical switching frequency	AC-15	1200 cycles/h
	DC-13	900 cycles/h
Mechanically linked contacts acc. to annex L of IEC 60947-5-1	Built-in N.O. or N.C. auxiliary contacts and additional N.O. or N.C. auxiliary contacts (CA3 aux. contact blocks) are mechanically linked contacts.	

Contact utilization characteristics according to UL / CSA

Contactor relay types	AC operated	NS
	DC operated	NSL
Standards	UL 508, CSA C22.2 N°14	
Max. operational voltage	600 V AC, 250 V DC	
Pilot duty	A600, Q300	
AC thermal rated current	10 A	
AC maximum volt-ampere making	7200 VA	
AC maximum volt-ampere breaking	720 VA	
DC thermal rated current	2.5 A	
DC maximum volt-ampere making-breaking	69 VA	

NS and NSL contactor relays

Technical data

Magnet system characteristics for NS contactor relays

Contactor relay types	AC operated	NS
Coil operating limits	AC supply	
acc. to IEC 60947-5-1		0.85...1.1 x U _c (at $\theta \leq 60$ °C); U _c (at $\theta \leq 70$ °C)
AC control voltage	Rated control circuit voltage U _c	at 50 Hz : 24...415 V at 60 Hz : 24...415 V
Coil consumption	Average pull-in value	50 Hz : 33 VA
		60 Hz : 33 VA
		50/60 Hz : 33 VA
		Average holding value 50 Hz : 6.5 VA / 1.5 W
		60 Hz : 5 VA / 1.2 W
	50/60 Hz : 6.5 VA / 1.5 W	
Drop-out voltage		Approx. 30...50 % of U _c
Operating time		
Between coil energization and:	N.O. contact closing	9...24 ms
	N.C. contact opening	6...18 ms
Between coil de-energization and:	N.O. contact opening (1)	5...19 ms
	N.C. contact closing (1)	7...22 ms
		(1) The use of RC5-1 surge suppressor increases opening time by a factor of 2 to 3.

Magnet system characteristics for NSL contactor relays

Contactor relay types	DC operated	NSL
Coil operating limits	DC supply	
acc. to IEC 60947-5-1		0.85...1.1 x U _c (at $\theta \leq 60$ °C); U _c (at $\theta \leq 70$ °C)
DC control voltage	Rated control circuit voltage U _c	12...240 V DC
Coil consumption	Average pull-in value	3 W
	Average holding value	3 W
Drop-out voltage		Approx. 10...40 % of U _c
Coil time constant	Open	L/R : 12 ms
	Closed	L/R : 40 ms
Operating time		
Between coil energization and:	N.O. contact closing	36...59 ms
	N.C. contact opening	31...53 ms
Between coil de-energization and:	N.O. contact opening (1)	13...17 ms
	N.C. contact closing (1)	15...20 ms
		(1) The use of RT5 surge suppressor increases opening time by a factor of 1.1 to 1.2.

Mounting characteristics and conditions for use

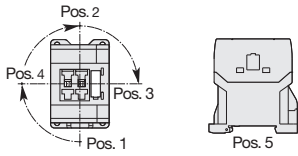
Contactor relay types	AC operated	NS
	DC operated	NSL
Mounting positions		
Mounting distances	The contactor relays can be assembled side by side.	
Fixing	On rail according to IEC 60715, EN 60715	35 x 7.5 mm or 35 x 15 mm
	By screws (not supplied)	2 x M4 screws placed diagonally



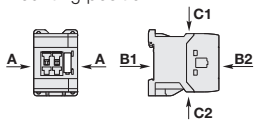

NS and NSL contactor relays

Technical data

General technical data

Contactor relay types	AC operated	NS
	DC operated	NSL
Rated insulation voltage U_i acc. to IEC 60947-5-1 acc. to UL / CSA		690 V 600 V
Rated impulse withstand voltage U_{imp} .		6 kV
Ambient air temperature close to contactor relay		
Operation in free air		-40...+70 °C
Storage		-60...+80 °C
Climatic withstand		Category B according to IEC 60947-1 Annex Q
Maximum operating altitude (without derating)		3000 m
Mechanical durability		
Number of operating cycles		20 millions operating cycles
Max. switching frequency		3600 cycles/h
Shock withstand acc. to IEC 60068-2-27 and EN 60068-2-27		1/2 sinusoidal shock for 11 ms: no change in contact position, closed or open position
Mounting position 1	Shock direction	NS contactor relays - AC operated
	A	20 g
	B1	5 g
	B2	15 g
	C1	19 g closed position / 8 g open position
	C2	16 g closed position / 13 g open position
		NSL contactor relays - DC operated
		20 g closed position / 10 g open position
		15 g closed position / 5 g open position
		10 g
		19 g closed position / 8 g open position
		14 g closed position / 8 g open position
Vibration withstand acc. to IEC 60068-2-6		5...300 Hz / 3 g closed position / 2 g open position

Connecting characteristics

Contactor relay types	AC operated	NS
	DC operated	NSL
Main terminals		Screw terminals with cable clamp
Connection capacity (min. ... max.)		
Pole and coil terminals		
 Rigid solid	1 x	0.75...2.5 mm ²
	2 x	0.75...2.5 mm ²
 Flexible with non insulated ferrule	1 x	0.75...2.5 mm ²
	2 x	0.75...2.5 mm ²
 Flexible with insulated ferrule	1 x	0.75...2.5 mm ²
	2 x	0.75...1.5 mm ²
 Lugs	L ≤	7.7 mm
	L >	3.2 mm
Connection capacity acc. to UL / CSA	1 or 2 x	AWG 18...14
Stripping length		9 mm
Tightening torque	Recommended	1.00 Nm / 9 lb.in
	Max.	1.20 Nm
Degree of protection acc. to IEC 60947-1 / EN 60947-1 and IEC 60529 / EN 60529		IP20
All terminals		Delivered in open position, screws of unused terminals must be tightened
Screw terminals		M3
All terminals	Screwdriver type	Flat Ø 5.5 / Pozidriv 2

Accessories for AS contactors and NS contactor relays

Auxiliary contact blocks	4/32
Frontal electronic timers	4/33
Surge suppressors	4/34
Mechanical interlock unit and fixing clips	4/35
Connection accessories for starting solutions	4/36

Auxiliary contact blocks

Accessories



CA3-10

1SBC101432S0201

Description



The auxiliary contact blocks are used for the operation of auxiliary circuits and control circuits. CA3 1-pole auxiliary contact blocks, designed for standard industrial environments, are equipped with:

- N.O. or N.C. contacts.
- Screw-type connecting terminals with cage clamp delivered open.

All 1-pole auxiliary contact blocks are protected against accidental direct contact and bear the corresponding function marking.

A maximum of two 1-pole auxiliary contact blocks can be front-mounted on 1-stack contactors or 1-stack contactor relays.

Ordering details

For contactors	For contactor relays	Contact blocks	Type	Order code	Pkg qty	Weight (1 pce)
						kg
						

1-pole auxiliary contact blocks with screw terminals

AS09 ... AS16	NS, NSL	1 -	CA3-10	1SBN011010T1010	10	0.011
ASL09 ... ASL16		- 1	CA3-01	1SBN011010T1001	10	0.011

Main dimensions mm, inches

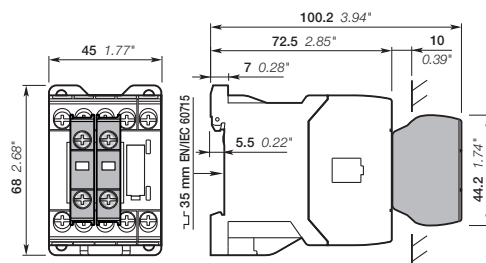

Electronic timers



TEF3-ON

1SBC101339FF010



TEF3-OFF

1SBC101338FF010

Description

TEF3 frontal electronic timers are used for realizing timing function independently of the control system and are available in ON-delay and OFF-delay versions.

Compact solution in cabinet compared to separate timers

TEF3 electronic timers are front-mounted and locked on AS/ASL contactors or NS/NSL contactor relays. A mechanical indicator allows to show the state of the contactor.



Safe and cost-reduced wiring

TEF3 electronic timers are supplied by a direct plug-in parallel connection to the coil terminals A1 - A2 of the contactor or contactor relay. A varistor is integrated on the timer to offer a built-in protection against surges in the contactor coil.

Available for a wide control voltage range 24...240 V AC/DC

TEF3-ON or TEF3-OFF allow time-delayed functions up to 100 s in 3 distinct time ranges, independently of the control system. The time delay ranges are selected by a switch and the time delay can be adjusted by means of a rotary switch. The timing function is activated by closing the device on which the timer is mounted. The OFF-delay version operates without additional control supply.

Ordering details

For contactors, contactor relays	Time delay range selected by switch	Delay type	Rated control circuit voltage U _c	Auxiliary contacts	Type	Order code	Weight Pkg (1 pce) kg
AS09 ... AS16	0.1...1 s	ON-delay	24...240	1 1	TEF3-ON	1SBN021012R1000	0.065
ASL09 ... ASL16	1...10 s		V 50/60 Hz or DC	 			
NS, NSL	10...100 s	OFF-delay	24...240	1 1	TEF3-OFF	1SBN021014R1000	0.065

Main dimensions mm, inches

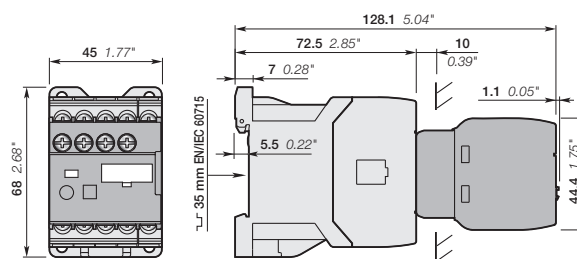

1SBC101504S0201

Surge suppressors for contactor coils

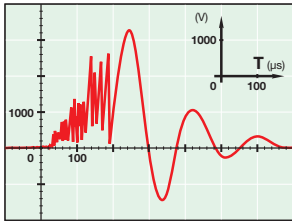

Description

The operation of inductive circuits causes overvoltages, in particular on opening the contactor coil. The electromagnetic energy stored in the coil during contactor closing is restored on opening in the form of surges, the slope and amplitude of which may rise to several kilovolts. A number of drawbacks are observed ranging from interference on the electronic devices to the breakdown of insulators and even the destruction of certain sensitive components. The graph opposite reproduces the oscillogram showing voltage discharges at the terminals of a 42 V / 50 Hz coil without peak clipping. The coil was switched by 8 series-connected poles of a contactor relay. Following a burst of discharges with a very steep slope, a damped oscillation emerges with a peak value of 3500 V.

Overvoltage Factor

The overvoltage factor k is defined as the ratio of the maximum overvoltage peak value \hat{U}_s to the peak value \hat{U}_c of the coil rated control voltage U_c :

$$k = \frac{\hat{U}_s \text{ max.}}{\hat{U}_c} \quad \text{in DC} \quad k = \frac{\hat{U}_s \text{ max.}}{U_c} \quad \text{in AC} \quad k = \frac{\hat{U}_s \text{ max.}}{U_c \sqrt{2}}$$

For example the following is obtained for the above graph: $k = \frac{3500}{42 \sqrt{2}} \approx 60$

To reduce the harmful effects of these overvoltages, ABB has developed a range of surge suppressors designed to reduce the k factor defined above and to limit or even completely eliminate the high pre-damping voltage frequencies.

Each case is different, but the technical data tolerances and generous sizing of parts have enabled us to reduce the number of variants.

We have chosen the following solutions: transil diodes, varistors and RC blocks.

Note: A varistor is a resistor whose value decreases to a very large extent when a certain voltage is applied at its terminals.

Ordering details

For contactors	For contactor relays	Rated control circuit voltage - U_c			Type	Order code	Pkg qty	Weight (1 pce) kg
		V	AC	DC				
AS, ASL	NS, NSL	24...50	●	●	RV5/50	1SBN050010R1000	2	0.015
		50...133	●	●	RV5/133	1SBN050010R1001	2	0.015
		110...250	●	●	RV5/250	1SBN050010R1002	2	0.015
		250...440	●	●	RV5/440	1SBN050010R1003	2	0.015
AS	NS	24...50	●	-	RC5-1/50	1SBN050100R1000	2	0.012
		50...133	●	-	RC5-1/133	1SBN050100R1001	2	0.012
		110...250	●	-	RC5-1/250	1SBN050100R1002	2	0.012
		250...440	●	-	RC5-1/440	1SBN050100R1003	2	0.012
ASL	NSL	12...32	-	●	RT5/32	1SBN050020R1000	2	0.015
		25...65	-	●	RT5/65	1SBN050020R1001	2	0.015
		50...90	-	●	RT5/90	1SBN050020R1002	2	0.015
		77...150	-	●	RT5/150	1SBN050020R1003	2	0.015
		150...264	-	●	RT5/264	1SBN050020R1004	2	0.015

Main dimensions mm, inches

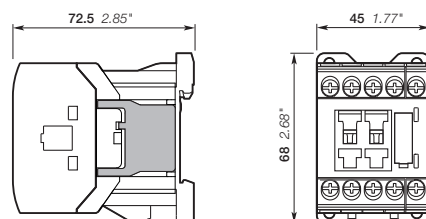

Easy connection to the coil terminals
(parallel mounting)
Clip-on for both fixing and connection.

No additional space
Clipped onto the right side part of the contactor base without changing contactor overall dimensions and keeping a free access to coil terminals.

1SBC10143AS0201



RV5



RC5-1



RT5

Mechanical interlock unit and fixing clips



VM3



BB3

Mechanical interlock unit

When mounted between two contactors without additional width, the VM3 mechanical interlock unit prevents one of the contactors from closing as long as the other contactor is closed.

The mechanical interlock unit includes 2 fixing clips.

Ordering details

For contactors		Type	Order code	Pkg qty	Weight (1 pce)
Left	Right				kg
AS	AS	VM3	1SBN031005T1000	10	0.002
ASL	ASL				

Note : VM3 mechanical durability, 5 millions of operating cycles on both reversing contactors.

Fixing clips

BB3 is a set of 50 fixing clips.

Ordering details

For contactors	Type	Order code	Pkg qty	Weight (1 pce)
AS, ASL	BB3	1SBN111020R1000	1	0.009

Connection accessories for starting solutions

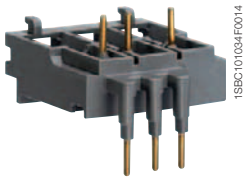

BEA16-3

1SBC101034F0014

Connecting links

The BEA16-3 insulated 3-pole connecting links are used to connect an AC or DC operated contactors with manual motor starters.

The connecting links ensure the electrical and mechanical connection between the contactor and the manual motor starter.

Ordering details

For contactors	Manual motor starter	Type	Order code	Pkg qty	Weight (1 pce) kg
AS09 ... AS16 ASL09 ... ASL16	MS116-0.16 ... MS116-16 MS132-0.16 ... MS132-16	BEA16-3	1SBN081006T1000	10	0.019

4

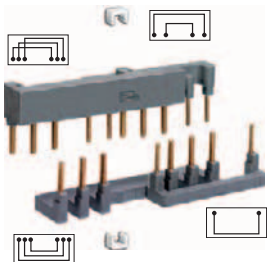

BER16C-3

1SBC101071F0014

Connection sets for reversing contactors

The BER16C-3 connection sets are used for the connections between the main poles of two 3-pole contactors mounted side by side as reversing contactors, including electrical interlocking between built-in N.C. auxiliary contact and coil terminals.

The connection sets are made up of:

- 1 upstream and 1 downstream connections: insulated, solid copper bars,
- 2 connections to realize electrical interlocking between contactors equipped with built-in N.C. auxiliary contacts,
- 2 fixing clips.

Ordering details

For contactors	Mechanical interlock unit	Type	Order code	Pkg qty	Weight (1 pce) kg
2 x AS09 ... AS16 2 x ASL09 ... ASL16	with or without VM3	BER16C-3	1SBN081012R1000	1	0.035

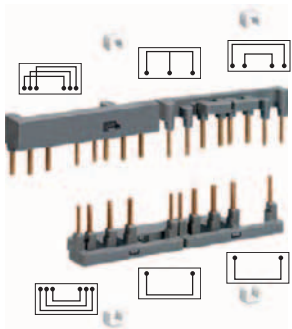

BEY16C-3

1SBC101076F0014

Connection sets for star-delta starting

BEY16C-3 connection sets are designed for star-delta starters whose contactors are assembled according to line delta star mounting.

The connection sets are made up of:

- Line contactor / delta contactor: upstream phase-to-phase connection,
- Delta contactor / star contactor: downstream connection in parallel,
- Star contactor: star point upstream,
- An electrical interlocking between delta and star contactors equipped with built-in N.C. auxiliary contacts,
- 4 fixing clips.

Ordering details

For contactors			Mech. interlock unit between star & delta contactors	Type	Order code	Pkg qty	Weight (1 pce) kg
Line	Delta	Star					
AS09	AS09	AS09	with or without VM3	BEY16C-3	1SBN081018R2000	1	0.041
AS12	AS12	AS09					

Voltage code table

The below tables indicate the available coil voltages and corresponding digits for order codes. When placing an order, please give either type or order code. Select a standard contactor from ordering detail pages. Change the **coil voltage code** in the type or in the order code according to the table below. Example: for contactor AS09-30-10 and coil 42 V 50/60 Hz, type is AS09-30-10-21 and order code is 1SBL101001R2110.

3-pole contactors

Type AS16 - 30 - 10 - 26

Order code 1SBL121001R 26 10

AC coil code

	50 Hz	60 Hz
20	24 V	24 V
21	42 V	42 V
22	48 V	48 V
23	110 V	110 V
24	115 V	115 V
16	-	120 V
25	220 V	220 V
26	230 V	230 V
27	240 V	240 V
17	-	277 V
13	380 V	-
28	400 V	400 V
29	415 V	415 V

DC coil code

80	12 V
81	24 V
83	48 V
84	60 V
86	110 V
87	125 V
88	220 V
89	240 V

Contactor type

AS	AC operated
ASL	DC operated

Diagram details: AS16 (Type), 30 (Main contacts), 10 (Auxiliary contacts: N.O., N.C.), 26 (Coil voltage code). Order code: 1SBL121001R 26 10.

3-pole reversing contactors

Type VAS12 S EM - 26 M

Order code 1SBK113800M 26 00

AC coil code

	50 Hz	60 Hz
20	24 V	24 V
21	42 V	42 V
22	48 V	48 V
23	110 V	110 V
24	115 V	115 V
16	-	120 V
25	220 V	220 V
26	230 V	230 V
27	240 V	240 V
17	-	277 V
13	380 V	-
28	400 V	400 V
29	415 V	415 V

DC coil code

80	12 V (1)
81	24 V
83	48 V
84	60 V
86	110 V
87	125 V
88	220 V
89	240 V

Contactor type

VAS	AC operated
VASL	DC operated

Diagram details: VAS12 (Type), S (Surge suppressor), EM (Coil voltage code), M (Order code). Order code: 1SBK113800M 26 00.

(1) Not for VASL..SEM

Contactor relays

Type NS 40 E - 26

Order code 1SBH101001R 26 40

AC coil code

	50 Hz	60 Hz
20	24 V	24 V
21	42 V	42 V
22	48 V	48 V
23	110 V	110 V
24	115 V	115 V
16	-	120 V
25	220 V	220 V
26	230 V	230 V
27	240 V	240 V
17	-	277 V
13	380 V	-
28	400 V	400 V
29	415 V	415 V

DC coil code

80	12 V
81	24 V
83	48 V
84	60 V
86	110 V
87	125 V
88	220 V
89	240 V

Contactor type

NS	AC operated
NSL	DC operated

Diagram details: NS 40 E (Type), 26 (Coil voltage code). Order code: 1SBH101001R 26 40.



A, AF, EK contactors and NF contactor relays

AF, A 3-pole contactors

Contents	5/3
Overview 3-pole contactors	5/4
Ordering details 3-pole contactors	5/6
Technical data 3-pole contactors	5/28

AF, A and EK 4-pole contactors

Contents	5/55
Overview 4-pole contactors	5/56
Ordering details 4-pole contactors	5/58
Technical data 4-pole contactors	5/76

Contactors for capacitor switching

Contents	5/93
Overview	5/94
UA16..RA up to UA110..RA - Unlimited peak \hat{I}	5/96
UA16 up to UA110 - Peak current $\hat{I} \leq 100$ times the rms current	5/101

NF 4-pole contactor relays

Contents	5/107
Ordering details	5/108
Main accessories	5/110
Technical data	5/112

Accessories for A, AF, EK contactors and NF contactor relays

Accessories for AF09 ... AF38 contactors and NF contactor relays	5/115
Accessories for A40 ... AF2050 contactors	5/121
Accessories for EK100 ... EK1000 contactors	5/147

Voltage code table	5/157
--------------------	-------



AF, A 3-pole contactors

[Overview](#) 5/4

Ordering details

4 to 18.5 kW / 5 to 20 hp

AF09 ... AF38	AC / DC operated	5/6
AF09Z ... AF38Z	AC / DC operated - low consumption	5/7
Main accessories		5/8

18.5 to 37 kW / 30 to 60 hp

A40	AC operated	5/10
A50 ... A75	AC operated	5/11
AL40	DC operated	5/12
AE50 ... AE75	DC operated	5/13
AF50 ... AF75	AC / DC operated	5/14
Main accessories		5/16

45 to 55 kW / 60 to 75 hp

A95 ... A110	AC operated	5/18
AF95 ... AF110	AC / DC operated	5/19
Main accessories		5/20

75 to 560 kW / 100 to 900 hp

A145 ... A300	AC operated	5/22
AF145 ... AF300	AC / DC operated	5/23
AF400 ... AF750	AC / DC operated	5/24
AF1250 ... AF2050	AC / DC operated	5/25
Main accessories		5/26

Technical data

Main pole - Utilization characteristics according to IEC	5/28
Main pole - Utilization characteristics according to UL/NEMA/CSA	5/32
General technical data	5/32
Magnet system and mounting characteristics	5/36
Connecting characteristics	5/43
Built-in auxiliary contacts	5/47
Electrical durability	5/49

Accessories

Accessories for AF09 ... AF38 contactors and NF contactor relays	5/115
Accessories for A40 ... AF2050 contactors	5/121

[Voltage code table](#) 5/157

3-pole contactors, for all industrial applications and motor starting

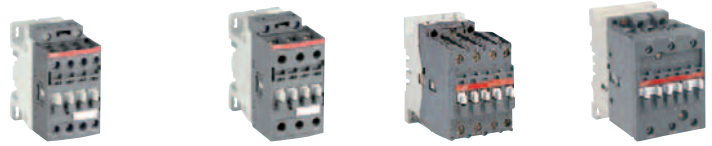

IEC	AC-3 Rated operational power	$\theta \leq 55^\circ\text{C}^*$, 400 V	kW	4	5.5	7.5	11	15	18.5	18.5	22	30	37
UL/CSA	3-phase motor rating	480 V	hp	5	7.5	10	15	20	20	30	40	60	60
AC Control supply		Type		AF09	AF12	AF16	AF26	AF30	AF38	A40	A50	A63	A75
DC Control supply		Type		AF09	AF12	AF16	AF26	AF30	AF38	AL40	AE50	AE63	AE75
AC / DC Control supply		Type		AF09	AF12	AF16	AF26	AF30	AF38	—	AF50	AF63	AF75
IEC	AC-3 Rated operational current	$\theta \leq 55^\circ\text{C}^*$, 400 V	A	9	12	18	26	32	38	37	50	65	75
	AC-1 Rated operational current	$\theta \leq 40^\circ\text{C}$, 690 V	A	25	28	30	45	50	50	60	100	115	125
UL/CSA	General use rating	600 V	A	25	28	30	45	50	50	60	80	90	105
NEMA	NEMA Size			00	0	—	1	—	—	—	2	—	3

* $\theta \leq 60^\circ\text{C}$ for AF09 ... AF38 contactors

Main accessories

Auxiliary contact blocks	Front mounting	CA4-10 (1 x N.O.), CA4-01 (1 x N.C.)	CA5-10 (1 x N.O.), CA5-01 (1 x N.C.)
	Side mounting	CAL4-11 (1 x N.O. + 1 x N.C.)	CAL5-11 (1 x N.O. + 1 x N.C.)
Timers	Pneumatic (Front mounting)		TP40DA, TP180DA Direct timing TP40IA, TP180IA Inverse timing
	Mechanical	VM4	VM5-1
Interlocking units	Mechanical / Electrical	VEM4	VE5-1 VE5-2
	For reversing contactors	BER16-4 BER38-4	BER40V BEM75-30
Surge suppressors	Varistor (AC / DC)		RV5 (24...440 V)
	RC type (AC)		RC5-1 (24...440 V) RC5-2 (24...440 V)
	Transil diode (DC)		RT5 (12...264 V)

Overload relays

Thermal relays		Class 10 (10A or 20 for TA42DU to TA80DU)	TF42 (0.10...38 A)	TA42DU (18...42 A)	TA75DU (18...80 A)
		Class 10E, 20E, 30E	EF19 (0.10...18.9 A)	EF19 (0.10...18.9 A), EF45 (9...45 A)	E45DU (9...45 A) E80DU (27...80 A)
Accessories for thermal overload relays		Remote tripping coil			
		Remote reset coil			
		Wall/separate mounting kit	DB42 (TF42 only)	DB80, DB45E, DB80E	

Manual motor starters

	Thermal / magnetic protection	Class 10	MS116 for class 10A (0.16...32 A) lcs up to 50 kA	MS450 (40...50 A) lcs up to 50 kA	
		Class 20	MS132 (0.10...32 A) lcs up to 100 kA		MS495 (28...100 A) lcs up to 50 kA
	Magnetic only types			MS497 (11...100 A) lcs up to 100 kA	
				MS451 (11...50 A) lcs up to 50 kA	MS496 (28...100 A) lcs up to 100 kA
			MO132 (0.10...32 A)	MO450 (16...50 A) lcs up to 50 kA	MO495
				MO496 (16...100 A) lcs up to 100 kA	
Accessories	For contactor mounting		BEA16-4	BEA38-4	BEA40/450 BEA50/450,
			HKF1, HK1, UA1, AA1, PS1, S1, SK1	HK4, HKS4, UA4, AA4, PS4, S4, SK4	
	Auxiliary trip units, auxiliary contacts, busbars		CK1 (MS132, MO132 only)		



45	55	75	90	110	140	160	200	250	315	400	—	475	560	—
60	75	100	125	150	200	250	350	400	500	600	—	800	900	—
A95	A110	A145	A185	A210	A260	A300	AF400	AF460	AF580	AF750	AF1250	AF1350	AF1650	AF2050
AF95	AF110	AF145	AF185	AF210	AF260	AF300	AF400	AF460	AF580	AF750	AF1250	AF1350	AF1650	AF2050
AF95	AF110	AF145	AF185	AF210	AF260	AF300	AF400	AF460	AF580	AF750	AF1250	AF1350	AF1650	AF2050
96	110	145	185	210	260	305	400	460	580	750	—	860	1050	—
145	160	250	275	350	400	500	600	700	800	1050	1260	1350	1650	2050
125	140	230	250	300	350	400	550	650	750	900	1210	1350	1650	2100
—	—	4	—	—	5	—	—	6	—	7	—	—	8	—

5

CAL18-11 (1 x N.O. + 1 x N.C.)			
VM300H / VM300V		VM750H / VM750V	
VM1650H			
BEM110-30	BEM185-30	BEM300-30	BEM460-30
RC5-3 (250...440V)			

TA80DU (29...80 A)	TA200DU (66...200 A)	TA450DU/SU (130...310 A)			
TA110DU (65...110 A)		class 30 for SU			
E140DU (50...140 A)	E200D-U (60...200 A)	E320DU (100...320 A)	E500DU (150...500 A)	E800DU (250...800 A)	E1250DU (375...1250 A)
		DS25-A			
		DR25-A			
DB80, DB200, D140E	DB200	DT450/A			

Circuit breakers

Tmax Circuit breaker and accessories

(40...100 A) lcs up to 50 kA

BEA75/495

18BEC101555S0201

AF09 ... AF38 3-pole contactors

4 to 18.5 kW

AC / DC operated



AF09-30-10

1SBC10109P0014

Description

AF09 ... AF38 contactors are mainly used for controlling 3-phase motors and power circuits up to 690 V AC and 220 V DC. These contactors are of the block type design with 3 main poles.

- control circuit: AC or DC operated with electronic coil interface accepting a wide control voltage range (e.g. 100...250 V AC and DC), only 4 coils to cover control voltages between 24...500 V 50/60 Hz and 20...500 V DC
- can manage large control voltage variations
- reduced panel energy consumption
- very distinct closing and opening.
- built-in surge suppression
- add-on auxiliary contact blocks for front or side mounting and a wide range of accessories.

Ordering details

IEC Rated power 400 V AC-3 kW	operational current $\theta \leq 40^\circ\text{C}$ AC-1 A	UL/CSA 3-phase motor rating 480 V hp	General use rating 600 V AC A	Rated control circuit voltage Uc min. ... Uc max.		Auxiliary contacts fitted		Type	Order code	Weight Pkg (1 pce) kg
				V 50/60 Hz	V DC					
4	25	5	25	24...60	20...60	(1)	1 0	AF09-30-10-11	1SBL137001R1110	0.270
							0 1	AF09-30-01-11	1SBL137001R1101	0.270
				48...130	48...130		1 0	AF09-30-10-12	1SBL137001R1210	0.270
							0 1	AF09-30-01-12	1SBL137001R1201	0.270
				100...250	100...250		1 0	AF09-30-10-13	1SBL137001R1310	0.270
5.5	28	7.5	28	24...60	20...60	(1)	1 0	AF12-30-10-11	1SBL157001R1110	0.270
							0 1	AF12-30-01-11	1SBL157001R1101	0.270
				48...130	48...130		1 0	AF12-30-10-12	1SBL157001R1210	0.270
							0 1	AF12-30-01-12	1SBL157001R1201	0.270
				100...250	100...250		1 0	AF12-30-10-13	1SBL157001R1310	0.270
7.5	30	10	30	24...60	20...60	(1)	1 0	AF16-30-10-11	1SBL177001R1110	0.270
							0 1	AF16-30-01-11	1SBL177001R1101	0.270
				48...130	48...130		1 0	AF16-30-10-12	1SBL177001R1210	0.270
							0 1	AF16-30-01-12	1SBL177001R1201	0.270
				100...250	100...250		1 0	AF16-30-10-13	1SBL177001R1310	0.270
11	45	15	45	24...60	20...60	(1)	0 0	AF26-30-00-11	1SBL237001R1100	0.310
							0 0	AF26-30-00-12	1SBL237001R1200	0.310
				100...250	100...250		0 0	AF26-30-00-13	1SBL237001R1300	0.310
							0 0	AF26-30-00-14	1SBL237001R1400	0.350
				250...500	250...500		0 0	AF26-30-00-14	1SBL237001R1400	0.350
15	50	20	50	24...60	20...60	(1)	0 0	AF30-30-00-11	1SBL277001R1100	0.310
							0 0	AF30-30-00-12	1SBL277001R1200	0.310
				100...250	100...250		0 0	AF30-30-00-13	1SBL277001R1300	0.310
							0 0	AF30-30-00-14	1SBL277001R1400	0.350
				250...500	250...500		0 0	AF30-30-00-14	1SBL277001R1400	0.350
18.5	50	20	50	24...60	20...60	(1)	0 0	AF38-30-00-11	1SBL297001R1100	0.310
							0 0	AF38-30-00-12	1SBL297001R1200	0.310
				100...250	100...250		0 0	AF38-30-00-13	1SBL297001R1300	0.310
							0 0	AF38-30-00-14	1SBL297001R1400	0.350
				250...500	250...500		0 0	AF38-30-00-14	1SBL297001R1400	0.350

(1) AF.-30...-11 not suitable for direct control by PLC-output.

Main dimensions mm, inches

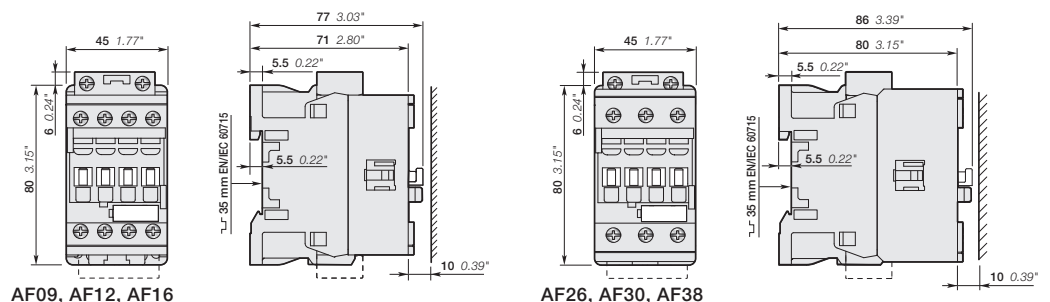

1SBC101671S0201

AF09Z ... AF38Z 3-pole contactors

4 to 18.5 kW

AC / DC operated - low consumption



AF09Z-30-10

1SBC101091F0014



AF26Z-30-00

1SBC101091F0014

Description

AF09Z ... AF38Z contactors are mainly used for controlling 3-phase motors and power circuits up to 690 V AC and 220 V DC. These contactors are of the block type design with 3 main poles.

- control circuit: AC or DC operated with electronic coil interface accepting a wide control voltage range (e.g. 100...250 V AC and DC), only 4 coils to cover control voltages between 24...250 V 50/60 Hz and 12...250 V DC
- can manage large control voltage variations
- allow direct control by PLC-output ≥ 24 V DC 500 mA
- reduced panel energy consumption
- very distinct closing and opening
- can withstand short voltage dips and voltage sags (SEMI F47-0706 conditions of use on request).
- built-in surge suppression
- add-on auxiliary contact blocks for front or side mounting and a wide range of accessories.

Ordering details

IEC Rated power 400 V AC-3 kW	operational current $\theta \leq 40^\circ\text{C}$ A	UL/CSA 3-phase motor rating 480 V hp	General use rating 600 V AC A	Rated control circuit voltage Uc min. ... Uc max.		Auxiliary contacts fitted	Type	Order code	Weight Pkg (1 pce) kg				
				V 50/60 Hz	V DC								
4	25	5	25	-	12...20	1 0	AF09Z-30-10-20	1SBL136001R2010	0.310				
						0 1	AF09Z-30-01-20	1SBL136001R2001	0.310				
				24...60	20...60	1 0	AF09Z-30-10-21	1SBL136001R2110	0.310				
						0 1	AF09Z-30-01-21	1SBL136001R2101	0.310				
				48...130	48...130	1 0	AF09Z-30-10-22	1SBL136001R2210	0.310				
						0 1	AF09Z-30-01-22	1SBL136001R2201	0.310				
				100...250	100...250	1 0	AF09Z-30-10-23	1SBL136001R2310	0.310				
						0 1	AF09Z-30-01-23	1SBL136001R2301	0.310				
				5.5	28	7.5	28	-	12...20	1 0	AF12Z-30-10-20	1SBL156001R2010	0.310
										0 1	AF12Z-30-01-20	1SBL156001R2001	0.310
24...60	20...60	1 0	AF12Z-30-10-21					1SBL156001R2110	0.310				
		0 1	AF12Z-30-01-21					1SBL156001R2101	0.310				
48...130	48...130	1 0	AF12Z-30-10-22					1SBL156001R2210	0.310				
		0 1	AF12Z-30-01-22					1SBL156001R2201	0.310				
100...250	100...250	1 0	AF12Z-30-10-23					1SBL156001R2310	0.310				
		0 1	AF12Z-30-01-23					1SBL156001R2301	0.310				
7.5	30	10	30					-	12...20	1 0	AF16Z-30-10-20	1SBL176001R2010	0.310
										0 1	AF16Z-30-01-20	1SBL176001R2001	0.310
				24...60	20...60	1 0	AF16Z-30-10-21	1SBL176001R2110	0.310				
						0 1	AF16Z-30-01-21	1SBL176001R2101	0.310				
				48...130	48...130	1 0	AF16Z-30-10-22	1SBL176001R2210	0.310				
						0 1	AF16Z-30-01-22	1SBL176001R2201	0.310				
				100...250	100...250	1 0	AF16Z-30-10-23	1SBL176001R2310	0.310				
						0 1	AF16Z-30-01-23	1SBL176001R2301	0.310				
				11	45	15	45	-	12...20	0 0	AF26Z-30-00-20	1SBL236001R2000	0.350
										0 0	AF26Z-30-00-21	1SBL236001R2100	0.350
24...60	20...60	0 0	AF26Z-30-00-22					1SBL236001R2200	0.350				
		0 0	AF26Z-30-00-23					1SBL236001R2300	0.350				
15	50	20	50					-	12...20	0 0	AF30Z-30-00-20	1SBL276001R2000	0.350
				0 0	AF30Z-30-00-21	1SBL276001R2100	0.350						
				24...60	20...60	0 0	AF30Z-30-00-22	1SBL276001R2200	0.350				
						0 0	AF30Z-30-00-23	1SBL276001R2300	0.350				
				18.5	50	20	50	-	12...20	0 0	AF38Z-30-00-20	1SBL296001R2000	0.350
0 0	AF38Z-30-00-21	1SBL296001R2100	0.350										
24...60	20...60	0 0	AF38Z-30-00-22					1SBL296001R2200	0.350				
		0 0	AF38Z-30-00-23					1SBL296001R2300	0.350				

Note: Only AF.Z contactors with DC control voltage 12...20 V DC need to respect the connection polarities indicated close to the coil terminals: A1+ for the positive pole and A2- for the negative pole.

Main dimensions mm, inches

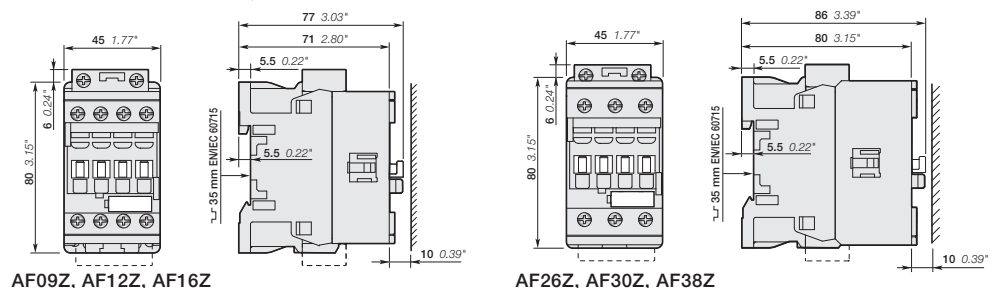

AF09Z, AF12Z, AF16Z

AF26Z, AF30Z, AF38Z

1SBC10137250201

AF09 ... AF38 3-pole contactors

Main accessories

Contactor and main accessories (other accessories available)

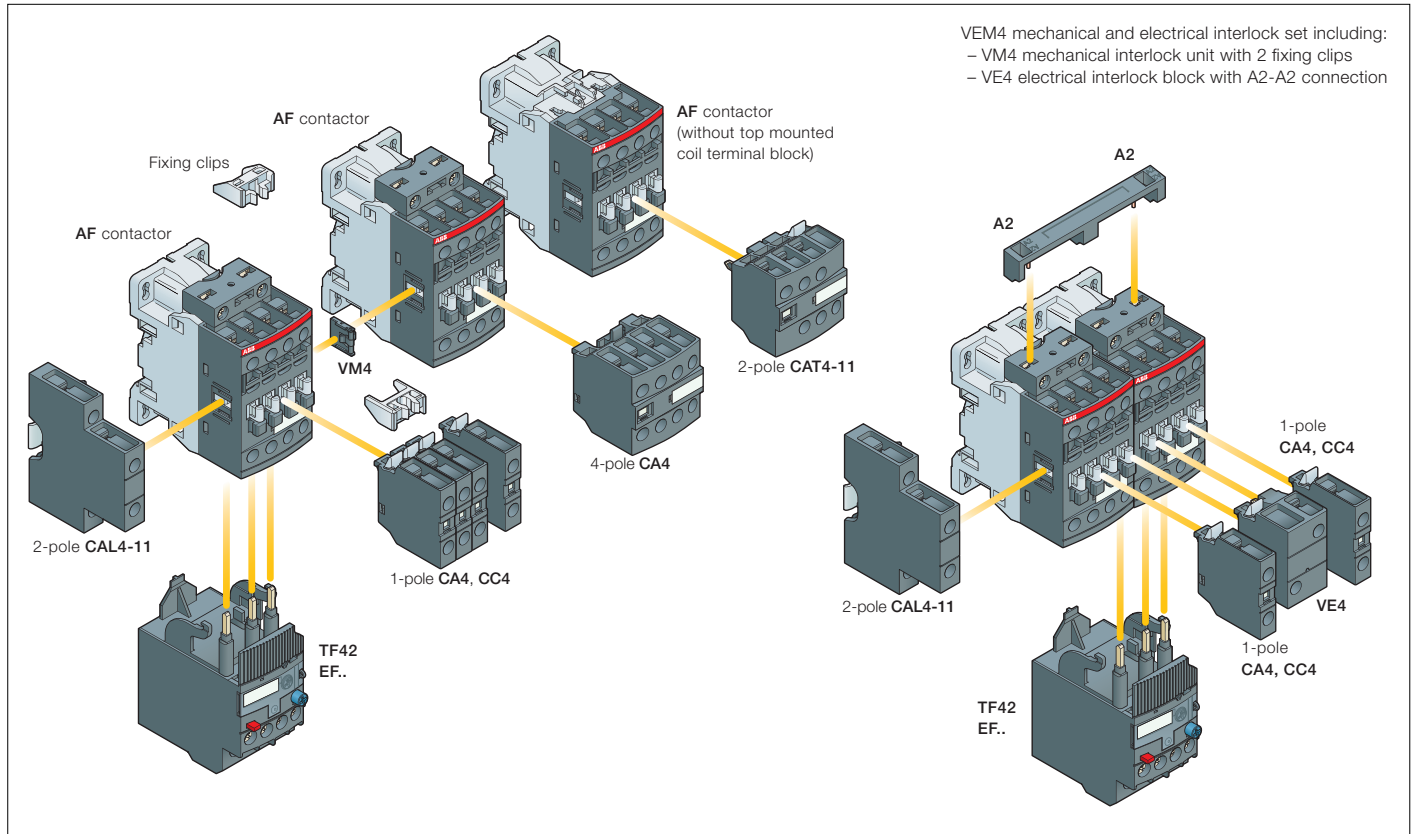

Main accessory fitting details

Many configurations of accessories are possible depending on whether these are front-mounted or side-mounted.

Contactor types	Main poles	Built-in auxiliary contacts	Front-mounted accessories				Electrical and mechanical interlock set (between 2 contactors)	Side-mounted accessories		
			Auxiliary contact blocks					Auxiliary contact blocks		
			1-pole CA4 1-pole CC4	2-pole CAT4-11	4-pole CA4	VEM4	Left side 2-pole CAL4-11	Right side		
Max. N.C. built-in and add-on N.C. auxiliary contacts: 4 N.C. max. on positions 1, 2, 3, 4 and 3 N.C. max. on positions 1 ±30°, 5										
AF09 ... AF16	3	0	0	1	4 max.	or 1	or 1	-	+ 1	-
					2 max.	-	-	-	+ 1	+ 1
					3 max.	-	-	+ 1	+ 1	or 1
AF09 ... AF16	3	0	1	0	4 max.	or 1	or 1	-	+ 1	-
AF26 ... AF38	3	0	0	0	2 max.	or 1	-	-	+ 1	+ 1
					3 max.	-	-	+ 1	+ 1	or 1

Overload relays fitting details (1)

Contactor types	Thermal overload relays	Electronic overload relays
AF09 ... AF38	TF42 (0.10...38 A)	EF19 (0.10...18.9 A)
AF26 ... AF38	-	EF45 (9...38 A)

The addition of an overload relay on the contactor does not prevent fitting of many other accessories as shown above.

(1) Direct mounting - No kit required.

AF09 ... AF38 3-pole contactors

Main accessories

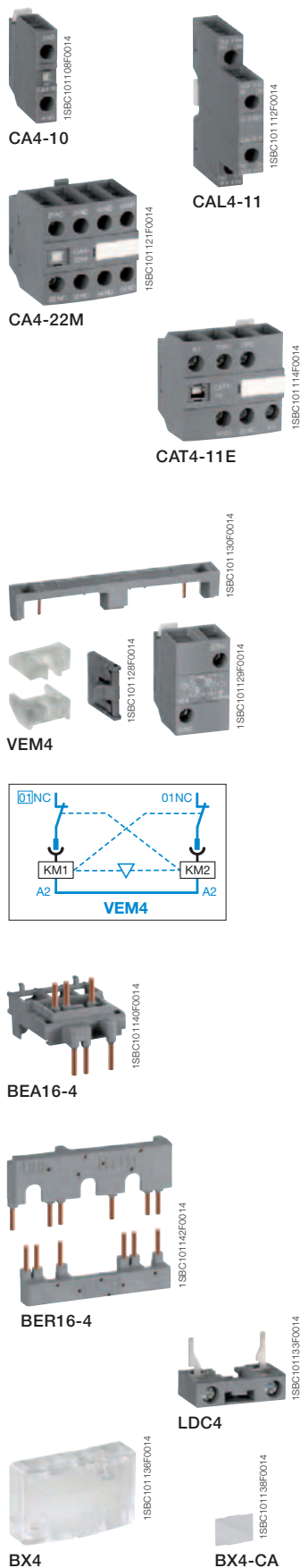

Ordering details (1)

For contactors	Auxiliary contacts	Type	Order code	Pkg qty	Weight (1 pce)
					kg

Front-mounted instantaneous auxiliary contact blocks

AF09 ... AF38	1 0	- -	CA4-10	1SBN010110R1010	1	0.014
	1 0	- -	CA4-10-T	1SBN010110T1010	10	0.014
	0 1	- -	CA4-01	1SBN010110R1001	1	0.014
	0 1	- -	CA4-01-T	1SBN010110T1001	10	0.014
AF09 ... AF16...-30-10	2 2	- -	CA4-22M	1SBN010140R1122	1	0.055
	3 1	- -	CA4-31M	1SBN010140R1131	1	0.055
	1 3	- -	CA4-13M	1SBN010140R1113	1	0.055
	0 4	- -	CA4-04M	1SBN010140R1104	1	0.055
AF26 ... AF38...-30-00	2 2	- -	CA4-22E	1SBN010140R1022	1	0.055
	3 1	- -	CA4-31E	1SBN010140R1031	1	0.055
	4 0	- -	CA4-40E	1SBN010140R1040	1	0.055
	0 4	- -	CA4-04E	1SBN010140R1004	1	0.055
AF09 ... AF16...-30-01	2 2	- -	CA4-22U	1SBN010140R1322	1	0.055
	3 1	- -	CA4-31U	1SBN010140R1331	1	0.055
	4 0	- -	CA4-40U	1SBN010140R1340	1	0.055

Front-mounted auxiliary contact blocks with N.O. leading contact and N.C. lagging contact

AF09 ... AF38	- -	1 0	CC4-10	1SBN010111R1010	1	0.014
	- -	0 1	CC4-01	1SBN010111R1001	1	0.014

Side-mounted instantaneous auxiliary contact blocks

AF09 ... AF38	1 1	- -	CAL4-11	1SBN010120R1011	1	0.040
	1 1	- -	CAL4-11-T	1SBN010120T1011	10	0.040

Front-mounted instantaneous auxiliary contact and A1/A2 coil terminal blocks

AF09 ... AF16...-30-10	1 1	- -	CAT4-11M	1SBN010151R1111	1	0.040
AF26 ... AF38...-30-00	1 1	- -	CAT4-11E	1SBN010151R1011	1	0.040
AF09 ... AF16...-30-01	1 1	- -	CAT4-11U	1SBN010151R1311	1	0.040

Note: CAT4 not fittable on AF.Z contactors with DC control voltage 12...20 V DC.

Mechanical interlock unit

AF09 ... AF38			VM4	1SBN030105T1000	10	0.005
---------------	--	--	-----	-----------------	----	-------

Note: VM4 includes 2 fixing clips (BB4) to maintain together both contactors.

Mechanical and electrical interlock set

AF09 ... AF16	1 1	- -	VEM4	1SBN030111R1000	1	0.035
AF26 ... AF38						

Note: - VEM4 includes a VM4 mechanical interlock unit with 2 fixing clips (BB4), a VE4 electrical interlock block. VE4 block must be used with A2-A2 connection to respect the electrical connection diagram.
- VEM4 not fittable on AF.Z contactors with DC control voltage 12...20 V DC.

Connecting links with manual motor starters

AF09 ... AF16	with	MS116-0.16 ... MS116-25, MS132-0.16 ... MS132-25	BEA16-4	1SBN081306T1000	10	0.025
AF26 ... AF38	with	MS116-0.16 ... MS116-16, MS132-0.16 ... MS132-10	BEA26-4	1SBN082306T1000	10	0.025
	with	MS116-20 ... MS116-32, MS132-12 ... MS132-32	BEA38-4	1SBN082306T2000	10	0.030

Connection sets for reversing contactors

AF09 ... AF16			BER16-4	1SBN081311R1000	1	0.045
AF26 ... AF38			BER38-4	1SBN082311R1000	1	0.100

Connection sets for star-delta starting

AF09 ... AF16			BEY16-4	1SBN081313R2000	1	0.050
AF26 ... AF38			BEY38-4	1SBN082713R2000	1	0.110

Note: with or without VM4 or VEM4

Additional coil terminal block

AF09 ... AF38			LDC4	1SBN070156T1000	10	0.010
---------------	--	--	------	-----------------	----	-------

Protective covers

All 1-stack contactors			BX4	1SBN110108T1000	10	0.006
For 4-pole CA4 and 2-pole CAT4 auxiliary contact blocks			BX4-CA	1SBN110109W1000	50	0.001

(1) See "Main accessory fitting details" table.

A40 3-pole contactors

18.5 kW

AC operated

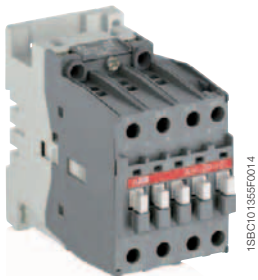

A40-30-10

1SBC101335F0014

Description

A40 contactors are mainly used for controlling 3-phase motors and power circuits up to 690 V AC or 220 V DC.

These contactors are of the block type design with:

- 3 main poles and 1 built-in auxiliary contact
- control circuit: AC operated
- add-on auxiliary contact blocks for front or side mounting and a wide range of accessories.

Ordering details

IEC		UL/CSA		Rated control circuit voltage U _c (1)		Auxiliary contacts fitted		Type	Order code	Weight
Rated operational power	current θ ≤ 40 °C	3-phase motor rating	General use rating							Pkg (1 pce)
400 V AC-3	AC-1	480 V	600 V AC	V 50 Hz	V 60 Hz					kg
18.5	60	30	60	24	24	1	0	A40-30-10	1SBL321001R8110	0.710
						0	1	A40-30-01	1SBL321001R8101	0.710
				48	48	1	0	A40-30-10	1SBL321001R8310	0.710
						0	1	A40-30-01	1SBL321001R8301	0.710
				110	110...120	1	0	A40-30-10	1SBL321001R8410	0.710
						0	1	A40-30-01	1SBL321001R8401	0.710
				220...230	230...240	1	0	A40-30-10	1SBL321001R8010	0.710
						0	1	A40-30-01	1SBL321001R8001	0.710
				230...240	240...260	1	0	A40-30-10	1SBL321001R8810	0.710
						0	1	A40-30-01	1SBL321001R8801	0.710
				380...400	400...415	1	0	A40-30-10	1SBL321001R8510	0.710
						0	1	A40-30-01	1SBL321001R8501	0.710
				400...415	415...440	1	0	A40-30-10	1SBL321001R8610	0.710
						0	1	A40-30-01	1SBL321001R8601	0.710

(1) Other control voltages see voltage code table.

Main dimensions mm, inches

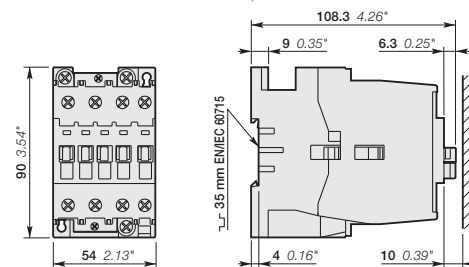

A40

1SBC101362S0201

A50 ... A75 3-pole contactors

22 to 37 kW

AC operated



A50-30-00

Description

A50 ... A75 contactors are mainly used for controlling 3-phase motors and power circuits up to 690 V AC / 1000 V AC or 220 V DC.

These contactors are of the block type design with:

- 3 main poles
- control circuit: AC operated
- add-on auxiliary contact blocks for front or side mounting and a wide range of accessories.

Ordering details

IEC Rated power 400 V AC-3 kW	operational current $\theta \leq 40^\circ\text{C}$ AC-1 A	UL/CSA 3-phase motor rating 480 V hp	General use rating 600 V AC A	Rated control circuit voltage Uc (1)		Auxiliary contacts fitted / /	Type	Order code	Weight Pkg (1 pce) kg
				V 50 Hz	V 60 Hz				
22	100	40	80	24	24	0 0	A50-30-00	1SBL351001R8100	1.160
				48	48	0 0	A50-30-00	1SBL351001R8300	1.160
				110	110...120	0 0	A50-30-00	1SBL351001R8400	1.160
				220...230	230...240	0 0	A50-30-00	1SBL351001R8000	1.160
				230...240	240...260	0 0	A50-30-00	1SBL351001R8800	1.160
				380...400	400...415	0 0	A50-30-00	1SBL351001R8500	1.160
30	115	60	90	24	24	0 0	A63-30-00	1SBL371001R8100	1.160
				48	48	0 0	A63-30-00	1SBL371001R8300	1.160
				110	110...120	0 0	A63-30-00	1SBL371001R8400	1.160
				220...230	230...240	0 0	A63-30-00	1SBL371001R8000	1.160
				230...240	240...260	0 0	A63-30-00	1SBL371001R8800	1.160
				380...400	400...415	0 0	A63-30-00	1SBL371001R8500	1.160
37	125	60	105	24	24	0 0	A75-30-00	1SBL411001R8100	1.160
				48	48	0 0	A75-30-00	1SBL411001R8300	1.160
				110	110...220	0 0	A75-30-00	1SBL411001R8400	1.160
				220...230	230...240	0 0	A75-30-00	1SBL411001R8000	1.160
				230...240	240...260	0 0	A75-30-00	1SBL411001R8800	1.160
				380...400	400...415	0 0	A75-30-00	1SBL411001R8500	1.160
				400...415	415...440	0 0	A75-30-00	1SBL411001R8600	1.160

(1) Other control voltages see voltage code table.

Main dimensions mm, inches

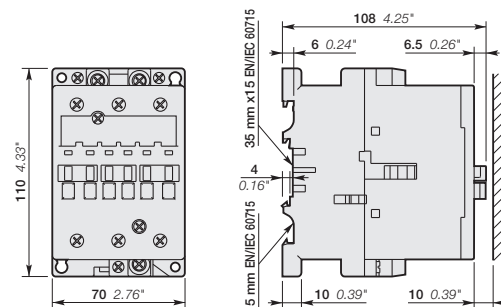

A50, A63, A75

AL40 3-pole contactors

18.5 kW

DC operated



1SBL323001R8001

AL40-30-10



Description

AL40 contactors are mainly used for controlling 3-phase motors and power circuits up to 690 V AC or 220 V DC.

These contactors are of the block type design with:

- 3 main poles and 1 built-in auxiliary contact
- control circuit: low consumption (3.5 W at pull-in and holding) DC operated with solid core magnet Suitable for direct control by PLC outputs (the polarity on the coil terminals A1+ and A2- must be respected)
- add-on auxiliary contact blocks for front or side mounting and a wide range of accessories.

Ordering details

IEC		UL/CSA		Rated control circuit voltage Uc (1)	Auxiliary contacts fitted	Type	Order code	Weight
Rated operational power	Rated operational current $\theta \leq 40^\circ\text{C}$	3-phase motor rating 480 V	General use rating 600 V AC					
400 V AC-3 kW	AC-1 A	hp	A	V DC	 			kg
18.5	60	30	60	12	1 0	AL40-30-10	1SBL323001R8010	0.850
					0 1	AL40-30-01	1SBL323001R8001	0.850
				24	1 0	AL40-30-10	1SBL323001R8110	0.850
					0 1	AL40-30-01	1SBL323001R8101	0.850
				48	1 0	AL40-30-10	1SBL323001R8310	0.850
					0 1	AL40-30-01	1SBL323001R8301	0.850
				60	1 0	AL40-30-10	1SBL323001R8410	0.850
					0 1	AL40-30-01	1SBL323001R8401	0.850
				110	1 0	AL40-30-10	1SBL323001R8610	0.850
					0 1	AL40-30-01	1SBL323001R8601	0.850
				125	1 0	AL40-30-10	1SBL323001R8710	0.850
					0 1	AL40-30-01	1SBL323001R8701	0.850
				220	1 0	AL40-30-10	1SBL323001R8810	0.850
					0 1	AL40-30-01	1SBL323001R8801	0.850
				240	1 0	AL40-30-10	1SBL323001R8910	0.850
					0 1	AL40-30-01	1SBL323001R8901	0.850

(1) Other control voltages see voltage code table.

Main dimensions mm, inches

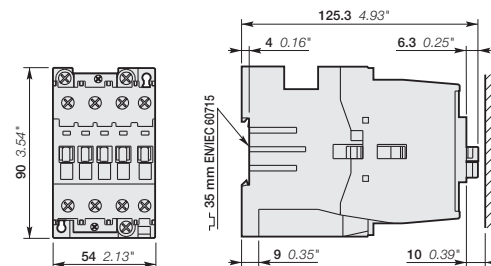

AL40

1SBL323001R8001

AE50 ... AE75 3-pole contactors

22 to 37 kW

DC operated



AE50-30-00



Description

AE50 ... AE75 contactors are mainly used for controlling 3-phase motors and power circuits up to 690 V AC / 1000 V AC or 220 V DC.

These contactors are of the block type design with:

- 3 main poles
- control circuit: DC operated with double winding coil (and factory-mounted lagging contact for "holding" winding insertion)
- add-on auxiliary contact blocks for front or side mounting and a wide range of accessories.

Ordering details

IEC		UL/CSA		Rated control circuit voltage Uc (1)	Auxiliary contacts fitted	Type	Order code	Weight
Rated operational power	current $\theta \leq 40^\circ\text{C}$	3-phase motor rating 480 V	General use rating 600 V AC					
400 V AC-3 kW	AC-1 A	hp	A	V DC	 			kg
22	100	40	80	12	0 0	AE50-30-00	1SBL359001R8000	1.200
				24	0 0	AE50-30-00	1SBL359001R8100	1.200
				48	0 0	AE50-30-00	1SBL359001R8300	1.200
				60	0 0	AE50-30-00	1SBL359001R8400	1.200
				110	0 0	AE50-30-00	1SBL359001R8600	1.200
				125	0 0	AE50-30-00	1SBL359001R8700	1.200
				220	0 0	AE50-30-00	1SBL359001R8800	1.200
30	115	60	90	240	0 0	AE50-30-00	1SBL359001R8900	1.200
				12	0 0	AE63-30-00	1SBL379001R8000	1.200
				24	0 0	AE63-30-00	1SBL379001R8100	1.200
				48	0 0	AE63-30-00	1SBL379001R8300	1.200
				60	0 0	AE63-30-00	1SBL379001R8400	1.200
				110	0 0	AE63-30-00	1SBL379001R8600	1.200
				125	0 0	AE63-30-00	1SBL379001R8700	1.200
37	125	60	105	220	0 0	AE63-30-00	1SBL379001R8800	1.200
				240	0 0	AE63-30-00	1SBL379001R8900	1.200
				12	0 0	AE75-30-00	1SBL419001R8000	1.200
				24	0 0	AE75-30-00	1SBL419001R8100	1.200
				48	0 0	AE75-30-00	1SBL419001R8300	1.200
				60	0 0	AE75-30-00	1SBL419001R8400	1.200
				110	0 0	AE75-30-00	1SBL419001R8600	1.200
				125	0 0	AE75-30-00	1SBL419001R8700	1.200
				220	0 0	AE75-30-00	1SBL419001R8800	1.200
				240	0 0	AE75-30-00	1SBL419001R8900	1.200

(1) Other control voltages see voltage code table.

Main dimensions mm, inches

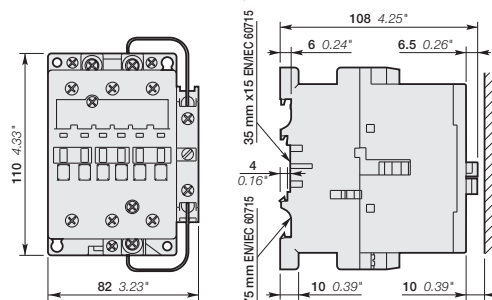

AE50, AE63, AE75

AF50 ... AF75 3-pole contactors

22 to 37 kW

AC / DC operated

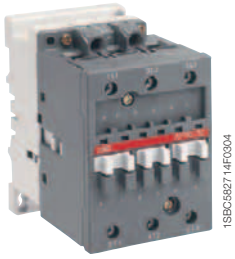

AF50-30-00

1SBC582714F0304

Description

AF50 ... AF75 contactors are mainly used for controlling 3-phase motors and generally for controlling power circuits up to 690 V AC and 220 V DC.

These contactors are of the block type design with:

- 3 main poles
- control circuit: AC or DC operated with electronic coil interface accepting a wide control voltage range (e.g. 100...250 V AC and DC)
 - can manage large control voltage variations
 - only 3 coils to cover control voltages between 48...250 V 50/60 Hz and 20...250 V DC
 - reduced panel energy consumption
 - very distinct closing and opening
 - can withstand short voltage dips and voltage sags (SEMI F47 conditions of use on request).
- built-in surge suppression
- add-on auxiliary contact blocks for front or side mounting and a wide range of accessories.

Ordering details

IEC		UL/CSA		Rated control circuit voltage		Auxiliary contacts fitted		Type	Order code	Weight
Rated operational power	current $\theta \leq 40^\circ\text{C}$	3-phase motor rating	General use rating	Uc min. ... Uc max.	Uc min. ... Uc max.	0	0			
400 V AC-3	AC-1	480 V	600 V AC	V 50 Hz	V 60 Hz					kg
22	100	40	80	-	20...60	0	0	AF50-30-00	1SBL357001R7200 (1)	1.180
				48...130	48...130	0	0	AF50-30-00	1SBL357001R6900	1.180
				100...250	100...250	0	0	AF50-30-00	1SBL357001R7000	1.180
30	115	60	90	-	20...60	0	0	AF63-30-00	1SBL377001R7200 (1)	1.180
				48...130	48...130	0	0	AF63-30-00	1SBL377001R6900	1.180
				100...250	100...250	0	0	AF63-30-00	1SBL377001R7000	1.180
37	125	60	105	-	20...60	0	0	AF75-30-00	1SBL417001R7200 (1)	1.180
				48...130	48...130	0	0	AF75-30-00	1SBL417001R6900	1.180
				100...250	100...250	0	0	AF75-30-00	1SBL417001R7000	1.180

(1) The connection polarities indicated close to the coil terminals must be respected: A1 for the positive pole and A2 for the negative pole.

Main dimensions mm, inches

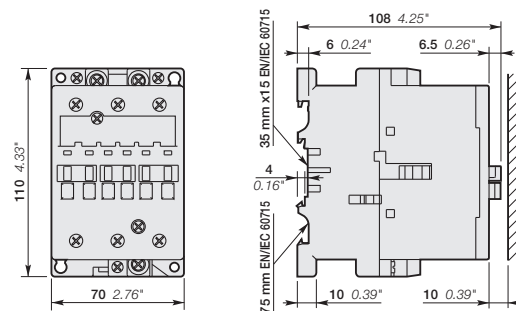

AF50, AF63, AF75

1SBC10136850201

Notes

A series of horizontal dotted lines for writing notes.

A40 ... A75, AL, AE and AF50 ... AF75 3-pole contactors

Main accessories

Contactor and main accessories (other accessories available)

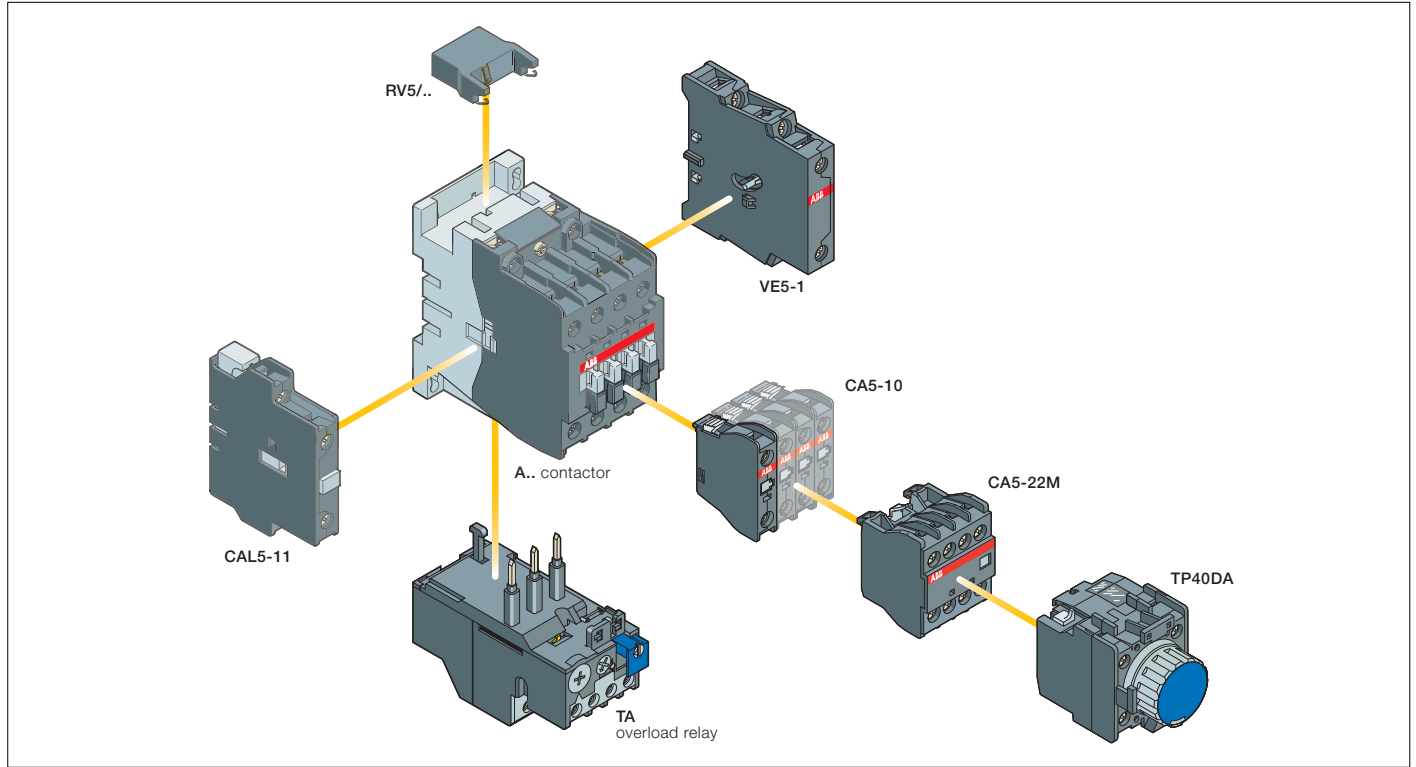

Main accessory fitting details

Many configurations of accessories are possible depending on whether these are front-mounted or side-mounted.

Contactor types	Main poles	Built-in auxiliary contacts	Front-mounted accessories			Side-mounted accessories	
			Auxiliary contact blocks		Pneumatic timer	Auxiliary contact blocks	Interlock unit
			1-pole CA5-..	4-pole CA5-..	TP. A	2-pole CAL5-11	VM5-.. or VE5-..
A40	3 0 1 0	0	1 to 5 x CA5-..	or 1 x CA5-.. (4-pole) + 1 x 1-pole CA5-..	or 1 x TP .. A + 1 x CA5-.. (1-pole)	+ 1 to 2 x CAL5-11	or 1 x VM5-1 or VE5-1 + 1 x CAL5-11
A50 ... A75	3 0 0 0	0	1 to 6 x CA5-..	or 1 x CA5-.. (4-pole) + 2 x 1-pole CA5-..	or 1 x TP .. A + 2 x CA5-.. (1-pole)	+ 1 to 2 x CAL5-11	or 1 x VE5-2 + 1 x CAL5-11
AL40	3 0 1 0	0	1 to 5 x CA5-.. (2)	or 1 x CA5-.. (4-pole) (2) + 1 x 1-pole CA5-..	-	or 1 x CAL5-11 (3)	+ 1 x VM5-1 or VE5-1 (1)
AE50 ... AE75	3 0 0 0	0	1 to 6 x CA5-..	or 1 x CA5-.. (4-pole) + 2 x 1-pole CA5-..	or 1 x TP .. A + 2 x CA5-.. (1-pole)	+ 1 x CAL5-11	or 1 x VE5-2
AF50 ... AF75	3 0 0 0	0	1 to 6 x CA5-..	or 1 x CA5-.. (4-pole) + 2 x 1-pole CA5-..	or 1 x TP .. A + 2 x CA5-.. (1-pole)	+ 1 to 2 x CAL5-11	or 1 x VE5-2 + 1 x CAL5-11

(1) With VE5-1 interlock unit, a maximum of 3 N.O. auxiliary contacts are permitted. VE5-1, VM5-1 not allowed in mounting position 1 ±30°.

(2) 2 N.C. CA5-.. auxiliary contacts maximum in mounting position 5.

(3) CAL5-11 not allowed in mounting position 1±30°.

Overload relays fitting details (4)

Contactor types	Thermal overload relays	Electronic overload relays
A40, AL40	TA25DU (0.1...32 A) or TA42DU (18...42 A)	E45DU (9...45 A)
A50 ... A75, AE50 ... AE75, AF50 ... AF75	TA75DU (18...80 A)	E80DU (27...80 A)

The addition of an overload relay on the contactor does not prevent fitting of many other accessories as shown above.

(4) Direct mounting - No kit required.

A40 ... A75, AL, AE and AF50 ... AF75 3-pole contactors

Main accessories



CA5-10



CAL5-11



RV5/50



TP40DA



VE5-1

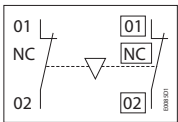

VE5-1, VE5-2

Terminal marking and positioning

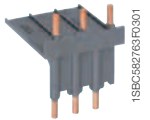

BEA40/450

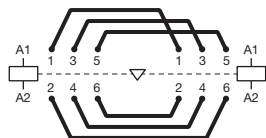

BER, BEM connection sets

Ordering details (1)

For contactors	Auxiliary contacts	Type	Order code	Pkg qty	Weight (1 pce)
					kg

Front-mounted instantaneous auxiliary contact blocks

A40 ... A75, AL40, AE50 ... AE75,	1	-	CA5-10	1SBN010010R1010	10	0.014
AF50 ... AF75	-	1	CA5-01	1SBN010010R1001	10	0.014
A40-30-10, AL40-30-10	2	2	CA5-22M	1SBN010040R1122	2	0.060
A40-30-01, AL40-30-01	2	2	CA5-22U	1SBN010040R1322	2	0.060
A50 ... A75, AE50 ... AE75, AF50 ... AF75	2	2	CA5-22E	1SBN010040R1022	2	0.060

Side-mounted instantaneous auxiliary contact block

A40 ... A75, AL40, AE50 ... AE75, AF50 ... AF75	1	1	CAL5-11	1SBN010020R1011	2	0.050
---	---	---	---------	-----------------	---	-------

Pneumatic timer blocks

A40 ... A75,	delay on energization	0.1...40 s	1	1	TP40DA	1SBN020300R1000	1	0.070
AE50 ... AE75,		10...180 s	1	1	TP180DA	1SBN020300R1001	1	0.070
AF50 ... AF75	delay on de-energization	0.1...40 s	1	1	TP40IA	1SBN020301R1000	1	0.070
		10...180 s	1	1	TP180IA	1SBN020301R1001	1	0.070
Timer accessory	plastic sealable cover		-	-	BX-TP	FPTN472657R0001	1	0.006

Interlock units

A40, AL40	Mechanical	-	-	VM5-1	1SBN030100R1000	1	0.066
	Mechanical and electrical	-	2	VE5-1	1SBN030110R1000	1	0.076
A50 ... A75,	Mechanical and electrical	-	2	VE5-2	1SBN030210R1000	1	0.146
AE50 ... AE75,							
AF50 ... AF75							

Surge suppressors

For contactors	Rated control circuit voltage U _c		Type	Order code	Pkg qty	Weight (1 pce)
	V	AC DC				
A40 ... A75	24...50	● ●	RV5/50	1SBN050010R1000	2	0.015
AL40	50...133	● ●	RV5/133	1SBN050010R1001	2	0.015
AE40 ... AE75	110...250	● ●	RV5/250	1SBN050010R1002	2	0.015
	250...440	● ●	RV5/440	1SBN050010R1003	2	0.015
A40	24...50	● -	RC5-1/50	1SBN050100R1000	2	0.012
	50...133	● -	RC5-1/133	1SBN050100R1001	2	0.012
	110...250	● -	RC5-1/250	1SBN050100R1002	2	0.012
	250...440	● -	RC5-1/440	1SBN050100R1003	2	0.012
A50 ... A75	24...50	● -	RC5-2/50	1SBN050200R1000	2	0.015
	50...133	● -	RC5-2/133	1SBN050200R1001	2	0.015
	110...250	● -	RC5-2/250	1SBN050200R1002	2	0.015
	250...440	● -	RC5-2/440	1SBN050200R1003	2	0.015
AL40	12...32	- ●	RT5/32	1SBN050020R1000	2	0.015
AE50 ... AE75	25...65	- ●	RT5/65	1SBN050020R1001	2	0.015
	50...90	- ●	RT5/90	1SBN050020R1002	2	0.015
	77...150	- ●	RT5/150	1SBN050020R1003	2	0.015
	150...264	- ●	RT5/264	1SBN050020R1004	2	0.015

Connecting links with manual motor starters

A40	For MS450 manual motor starter	BEA40/450	1SBN083206R1000	1	0.061
A50, AE50, AF50	For MS450 manual motor starter	BEA50/450	1SBN083506R1000	1	0.062
A50 ... A75,	For MS495 manual motor starter	BEA75/495	1SBN084106R1000	1	0.120
AE50 ... AE75,					
AF50 ... AF75					

Connection sets for reversing contactors

A40	BER40V	1SBN082411R1000	1	0.085
A50 ... A75, AE50 ... AE75, AF50 ... AF75	BEM75-30	1SBN083501R1000	1	0.243

(1) See "Main accessory fitting details" table.

A95 ... A110 3-pole contactors

45 to 55 kW

AC operated



A95-30-00

1SBE0573242F001

Description

A95 ... A110 contactors are mainly used for controlling 3-phase motors and power circuits up to 690 / 1000 V AC or 220 V DC.

These contactors are of the block type design with:

- 3 main poles
- control circuit: AC operated
- add-on auxiliary contact blocks for front or side mounting and a wide range of accessories.

Ordering details

IEC		UL/CSA		Rated control circuit voltage U _c		Auxiliary contacts fitted		Type	Order code	Weight
Rated operational power	Rated operational current $\theta \leq 40^\circ\text{C}$	3-phase motor rating	General use rating	(1)		I L				Pkg (1 pce)
400 V AC-3	690 V AC-1	480 V	600 V AC	V 50 Hz	V 60 Hz					kg
45	145	60	125	24	24	0	0	A95-30-00	1SFL431001R8100	2.000
				48	48	0	0	A95-30-00	1SFL431001R8300	2.000
				110	110...120	0	0	A95-30-00	1SFL431001R8400	2.000
				220...230	230...240	0	0	A95-30-00	1SFL431001R8000	2.000
				230...240	240...260	0	0	A95-30-00	1SFL431001R8800	2.000
				380...400	400...415	0	0	A95-30-00	1SFL431001R8500	2.000
				400...415	415...440	0	0	A95-30-00	1SFL431001R8600	2.000
55	160	75	140	24	24	0	0	A110-30-00	1SFL451001R8100	2.000
				48	48	0	0	A110-30-00	1SFL451001R8300	2.000
				110	110...120	0	0	A110-30-00	1SFL451001R8400	2.000
				220...230	230...240	0	0	A110-30-00	1SFL451001R8000	2.000
				230...240	240...260	0	0	A110-30-00	1SFL451001R8800	2.000
				380...400	400...415	0	0	A110-30-00	1SFL451001R8500	2.000
				400...415	415...440	0	0	A110-30-00	1SFL451001R8600	2.000

(1) Other control voltages see voltage code table.

Main dimensions mm, inches

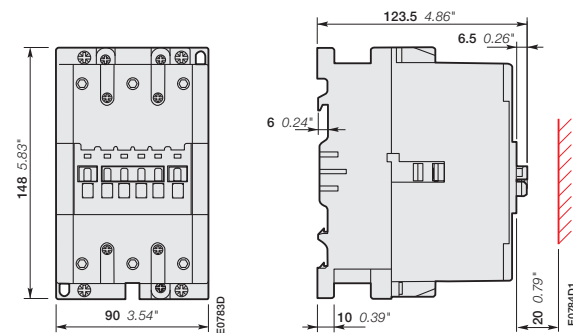

A95, A110

1SFC101007C0201

AF95 ... AF110 3-pole contactors

45 to 55 kW

AC / DC operated



AF95-30-00

1SFC101374F0014

Description

AF95 ... AF110 contactors are mainly used for controlling 3-phase motors and power circuits up to 690 / 1000 V AC or 220 V DC.

These contactors are of the block type design with:

- 3 main poles
- control circuit: AC or DC operated with electronic coil interface accepting a wide control voltage range (e.g. 100...250 V AC and DC)
- can manage large control voltage variations
 - only 3 coils to cover control voltages between 48...250 V 50/60 Hz and 20...250 V DC
 - reduced panel energy consumption
 - very distinct closing and opening
 - can withstand short voltage dips and voltages sags (SEMI F47 conditions of use on request).
- built-in surge suppression
- add-on auxiliary contact blocks for front or side mounting and a wide range of accessories.

Ordering details

IEC		UL/CSA		Rated control circuit voltage		Auxiliary contacts fitted		Type	Order code	Weight
Rated operational power	current $\theta \leq 40^\circ\text{C}$	3-phase motor rating	General use rating	Uc min. ...	Uc max.	I	L			
400 V AC-3	690 V AC-1	480 V	600 V AC	V 50/60 Hz	V DC					kg
45	145	60	125	-	20...60	0	0	AF95-30-00	1SFL437001R7200 (1)	2.030
				48...130	48...130	0	0	AF95-30-00	1SFL437001R6900	2.030
				100...250	100...250	0	0	AF95-30-00	1SFL437001R7000	2.030
55	160	75	140	-	20...60	0	0	AF110-30-00	1SFL457001R7200 (1)	2.030
				48...130	48...130	0	0	AF110-30-00	1SFL457001R6900	2.030
				100...250	100...250	0	0	AF110-30-00	1SFL457001R7000	2.030

(1) The connection polarities indicated close to the coil terminals must be respected: A1 for the positive pole and A2 for the negative pole.

Main dimensions mm, inches

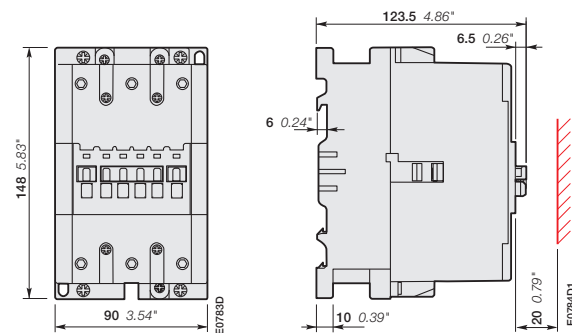

AF95, AF110

A95, A110 and AF95, AF110 3-pole contactors

Main accessories

Contactor and main accessories (other accessories available)

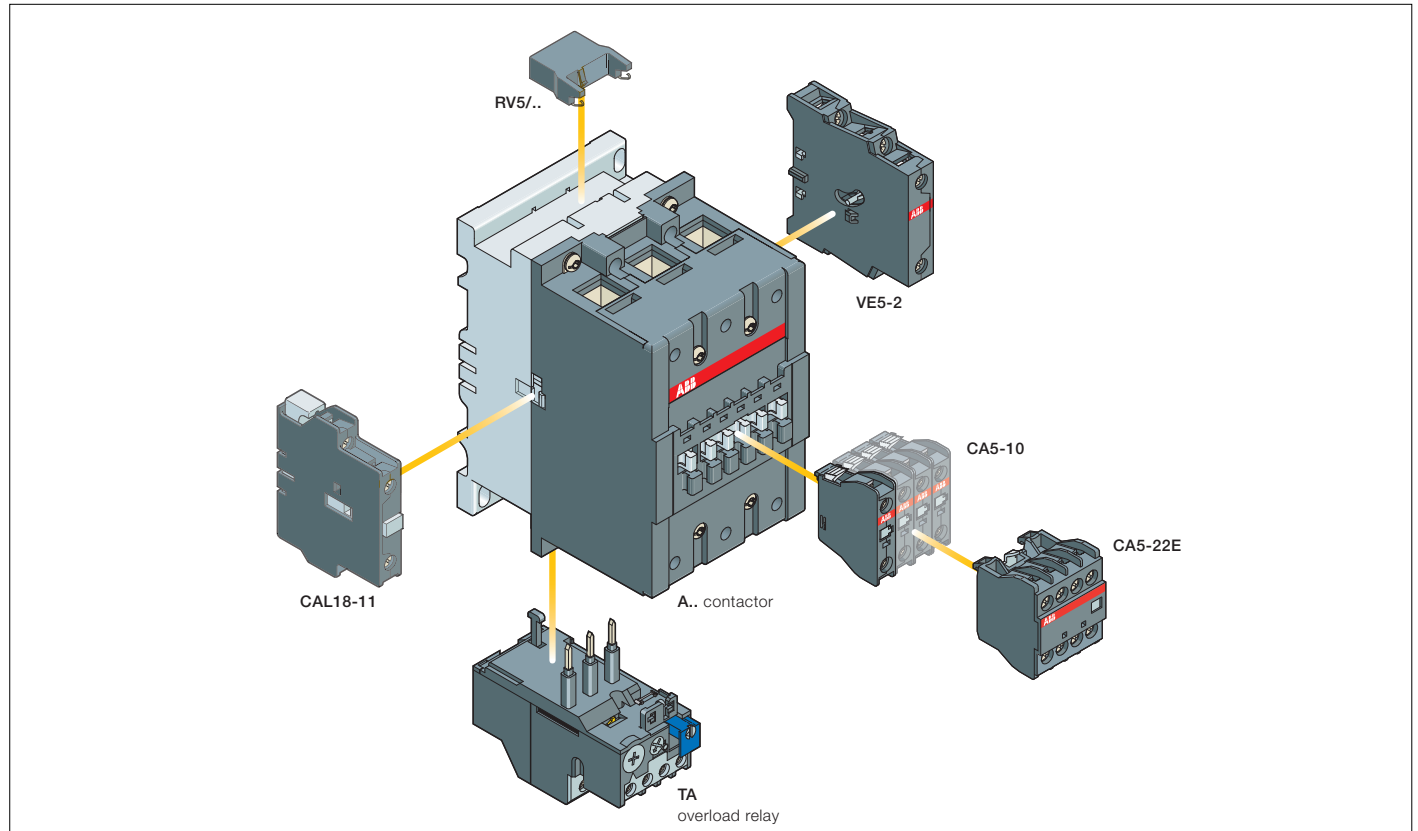

Main accessory fitting details

Many configurations of accessories are possible depending on whether these are front-mounted or side-mounted.

Contactor types	Main poles	Available auxiliary contacts	Front-mounted accessories		Side-mounted accessories	
			Auxiliary contact blocks	Auxiliary contact blocks	Interlock unit	
			1-pole CA5- ..	4-pole CA5- ..	2-pole CAL..	VE5-2
A95, A110	3	0 0 0	1 to 6 x CA5-..	or 1 x CA5-.. (4-pole) + 2 x 1-pole CA5-..	+ 1 to 2 x CAL18-11	or 1 x VE5-2 +1 x CAL18-11
AF95, AF110	3	0 0 0	1 to 6 x CA5-..	or 1 x CA5-.. (4-pole) + 2 x 1-pole CA5-..	+ 1 to 2 x CAL18-11	or 1 x VE5-2 +1 x CAL18-11

Overload relays fitting details (1)

Contactor types	Thermal overload relays	Electronic overload relays
A95, A110	TA80DU (29...80 A) or TA110DU (65...110 A)	E140DU (50...140 A)
AF95, AF110		

The addition of an overload relay on the contactor does not prevent fitting of many other accessories as shown above.

(1) Direct mounting - No kit required.

A95, A110 and AF95, AF110 3-pole contactors

Main accessories



CA5-10



CAL18-11

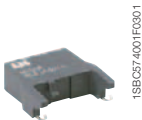

RV5/50

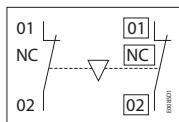

VE5-1, VE5-2

Terminal marking and positioning

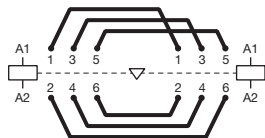

BEM... connection set

Ordering details (1)

For contactors	Auxiliary contacts	Type	Order code	Pkg qty	Weight (1 pce)
					kg

Front-mounted instantaneous auxiliary contact blocks

A95, A110 and AF95, AF110	1 -	CA5-10	1SBN010010R1010	10	0.014
	- 1	CA5-01	1SBN010010R1001	10	0.014
A95, A110 and AF95, AF110	2 2	CA5-22E	1SBN010040R1022	2	0.060

Side-mounted instantaneous auxiliary contact blocks

A95, A110 and AF95, AF110	1 1	CAL18-11	1SFN010720R1011	2	0.050
---------------------------	-----	----------	-----------------	---	-------

Mechanical and electrical interlock unit

A95, A110 and AF95, AF110	- 2	VE5-2	1SBN030210R1000	1	0.146
---------------------------	-----	-------	-----------------	---	-------

Surge suppressors

For contactors	Rated control circuit voltage U _c		Type	Order code	Pkg qty	Weight (1 pce)
	V	AC DC				
A95 ... A110	24...50	● ●	RV5/50	1SBN050010R1000	2	0.015
	50...133	● ●	RV5/133	1SBN050010R1001	2	0.015
	110...250	● ●	RV5/250	1SBN050010R1002	2	0.015
	250...440	● ●	RV5/440	1SBN050010R1003	2	0.015
A95 ... A110	24...50	● -	RC5-2/50	1SBN050200R1000	2	0.015
	50...133	● -	RC5-2/133	1SBN050200R1001	2	0.015
	110...250	● -	RC5-2/250	1SBN050200R1002	2	0.015
	250...440	● -	RC5-2/440	1SBN050200R1003	2	0.015

Connecting links with manual motor starters

A95, A110 and AF95, AF110	For MS495	BEA110/495	1SBN084506R1000	1	0.124
---------------------------	-----------	------------	-----------------	---	-------

Connection set for reversing contactors

A95, A110 and AF95, AF110		BEM110-30	1SFN084301R1000	1	0.450
---------------------------	--	-----------	-----------------	---	-------

Mounting plate for mechanical interlocked contactors

A95, A110 and AF95, AF110		PN110-21	1SFN094301R1000	1	0.600
---------------------------	--	----------	-----------------	---	-------

(1) See "Main accessory fitting details" table.

A145 ... A300 3-pole contactors

75 to 160 kW

AC operated with 1 N.O. + 1 N.C. auxiliary contacts



A185-30-11

1SFC101029F0201



A300-30-11

1SFC101030F0201

Description

A145 ... A300 contactors are mainly used for controlling 3-phase motors and power circuits up to 690 / 1000 V AC (2) or 220 V DC.

These contactors are of the block type design with:

- 3 main poles
- control circuit: AC operated
- add-on auxiliary contact blocks for side mounting and a wide range of accessories.

Ordering details

IEC Rated operational power 400 V AC-3 kW	operational current $\theta \leq 40^\circ\text{C}$ 690 V AC-1 A	UL/CSA 3-phase motor rating 480 V hp	General use rating 600 V AC A	Rated control circuit voltage Uc (1)		Auxiliary contacts fitted 	Type	Order code	Weight Pkg (1 pce) kg
				V 50 Hz	V 60 Hz				
75	250	100	230	24	24	1 1	A145-30-11	1SFL471001R8111	3.500
				48	48	1 1	A145-30-11	1SFL471001R8311	3.500
				110	110...120	1 1	A145-30-11	1SFL471001R8411	3.500
				220...230	230...240	1 1	A145-30-11	1SFL471001R8011	3.500
				230...240	240...260	1 1	A145-30-11	1SFL471001R8811	3.500
				380...400	400...415	1 1	A145-30-11	1SFL471001R8511	3.500
				400...415	415...440	1 1	A145-30-11	1SFL471001R8611	3.500
90	275	125	250	24	24	1 1	A185-30-11	1SFL491001R8111	3.500
				48	48	1 1	A185-30-11	1SFL491001R8311	3.500
				110	110...120	1 1	A185-30-11	1SFL491001R8411	3.500
				220...230	230...240	1 1	A185-30-11	1SFL491001R8011	3.500
				230...240	240...260	1 1	A185-30-11	1SFL491001R8811	3.500
				380...400	400...415	1 1	A185-30-11	1SFL491001R8511	3.500
				400...415	415...440	1 1	A185-30-11	1SFL491001R8611	3.500
110	350	150	300	24	24	1 1	A210-30-11	1SFL511001R8111	6.100
				48	48	1 1	A210-30-11	1SFL511001R8311	6.100
				110	110...120	1 1	A210-30-11	1SFL511001R8411	6.100
				220...230	230...240	1 1	A210-30-11	1SFL511001R8011	6.100
				230...240	240...260	1 1	A210-30-11	1SFL511001R8811	6.100
				380...400	400...415	1 1	A210-30-11	1SFL511001R8511	6.100
				400...415	415...440	1 1	A210-30-11	1SFL511001R8611	6.100
140	400	200	350	24	24	1 1	A260-30-11	1SFL531001R8111	6.100
				48	48	1 1	A260-30-11	1SFL531001R8311	6.100
				110	110...120	1 1	A260-30-11	1SFL531001R8411	6.100
				220...230	230...240	1 1	A260-30-11	1SFL531001R8011	6.100
				230...240	240...260	1 1	A260-30-11	1SFL531001R8811	6.100
				380...400	400...415	1 1	A260-30-11	1SFL531001R8511	6.100
				400...415	415...440	1 1	A260-30-11	1SFL531001R8611	6.100
160	500	250	400	24	24	1 1	A300-30-11	1SFL551001R8111	6.100
				48	48	1 1	A300-30-11	1SFL551001R8311	6.100
				110	110...120	1 1	A300-30-11	1SFL551001R8411	6.100
				220...230	230...240	1 1	A300-30-11	1SFL551001R8011	6.100
				230...240	240...260	1 1	A300-30-11	1SFL551001R8811	6.100
				380...400	400...415	1 1	A300-30-11	1SFL551001R8511	6.100
				400...415	415...440	1 1	A300-30-11	1SFL551001R8611	6.100

(1) Other control voltages see voltage code table.

(2) 690 V AC for A210 ... A300, 1000 V AC for A145, A185.

Main dimensions mm, inches

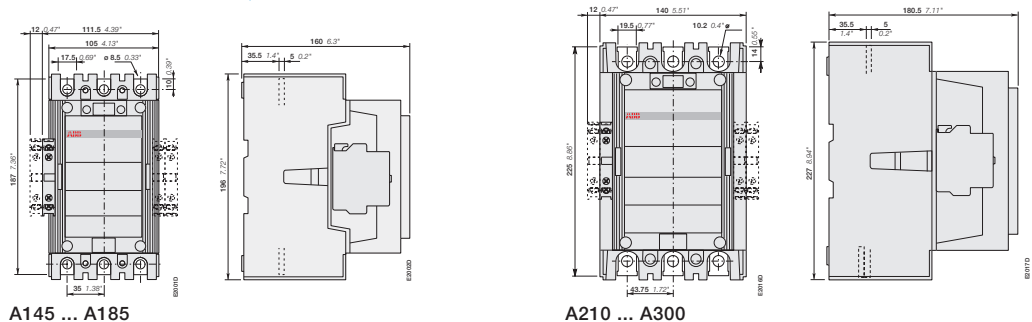

A145 ... A185

A210 ... A300

1SFC101009C0201

AF145 ... AF300 3-pole contactors

75 to 160 kW

AC / DC operated with 1 N.O. + 1N.C. auxiliary contacts



AF185-30-11

1SFC101023FC0201



AF300-30-11

1SFC101044F201

Description

AF145 ... AF300 contactors are mainly used for controlling 3-phase motors and power circuits up to 690 / 1000 V AC (2) or 220 V DC.

These contactors are of the block type design with:

- 3 main poles
- control circuit: AC or DC operated with electronic coil interface accepting a wide control voltage range (e.g. 100...250 V AC and DC)
 - can manage large control voltage variations
 - only 3 coils to cover control voltages between 48...250 V 50/60 Hz and 20...250 V DC
 - reduced panel energy consumption
 - very distinct closing and opening
 - can withstand short voltage dips and voltages sags (SEMI F47 conditions of use on request).
- built-in surge suppression
- add-on auxiliary contact blocks for side mounting and a wide range of accessories.

Ordering details

IEC Rated power 400 V AC-3 kW	operational current $\theta \leq 40^\circ\text{C}$ 690 V AC-1 A	UL/CSA 3-phase motor rating 480 V hp	General use rating 600 V AC A	Rated control circuit voltage Uc min. ... Uc max.		Auxiliary contacts fitted	Type	Order code	Weight Pkg (1 pce) kg
				V 50/60 Hz	V DC				
75	250	100	230	-	20...60	1 1	AF145-30-11	1SFL477001R7211 (1)	3.600
				48...130	48...130	1 1	AF145-30-11	1SFL477001R6911	3.600
				100...250	100...250	1 1	AF145-30-11	1SFL477001R7011	3.600
90	275	125	250	-	20...60	1 1	AF185-30-11	1SFL497001R7211 (1)	3.600
				48...130	48...130	1 1	AF185-30-11	1SFL497001R6911	3.600
				100...250	100...250	1 1	AF185-30-11	1SFL497001R7011	3.600
110	350	150	300	-	20...60	1 1	AF210-30-11	1SFL517001R7211 (1)	6.200
				48...130	48...130	1 1	AF210-30-11	1SFL517001R6911	6.200
				100...250	100...250	1 1	AF210-30-11	1SFL517001R7011	6.200
140	400	200	350	-	20...60	1 1	AF260-30-11	1SFL537001R7211 (1)	6.200
				48...130	48...130	1 1	AF260-30-11	1SFL537001R6911	6.200
				100...250	100...250	1 1	AF260-30-11	1SFL537001R7011	6.200
160	500	250	400	-	20...60	1 1	AF300-30-11	1SFL557001R7211 (1)	6.200
				48...130	48...130	1 1	AF300-30-11	1SFL557001R6911	6.200
				100...250	100...250	1 1	AF300-30-11	1SFL557001R7011	6.200

(1) The connection polarities indicated close to the coil terminals must be respected: A1 for the positive pole and A2 for the negative pole.
 (2) 690 V AC for AF210 ... AF300, 1000 V AC for AF145, AF185.

Main dimensions mm, inches



AF145 ... AF185

AF210 ... AF300

1SFC101011C0201

AF400 ... AF750 3-pole contactors

200 to 400 kW

AC / DC operated with 1 N.O. + 1 N.C. auxiliary contacts



AF460-30-11

1SFC101031F0201

Description

AF400 ... AF750 contactors are mainly used for controlling 3-phase motors and power circuits up to 1000 V AC or 600 V DC (2).

These contactors are of the block type design with:

- 3 main poles
- control circuit: AC or DC operated with electronic coil interface accepting a wide control voltage range (e.g. 100...500 V AC and DC)
 - can manage large control voltage variations
 - only 4 coils to cover control voltages between 48...500 V 50/60 Hz and 24...500 V DC
 - reduced panel energy consumption
 - very distinct closing and opening
 - can withstand short voltage dips and voltages sags (SEMI F47 conditions of use on request).
- built-in surge suppression
- add-on auxiliary contact blocks for side mounting and a wide range of accessories.

Ordering details

IEC Rated operational power 400 V AC-3 kW	UL/CSA 3-phase motor rating 480 V hp	General use rating 600 V AC A	Rated control circuit voltage Uc min. ... Uc max.		Auxiliary contacts fitted	Type	Order code	Weight kg	
			V 50/60 Hz	V DC					
200	600	350	550	-	24...60	1 1	AF400-30-11	1SFL577001R6811 (1)	12.000
				48...130	48...130	1 1	AF400-30-11	1SFL577001R6911	12.000
				100...250	100...250	1 1	AF400-30-11	1SFL577001R7011	12.000
				250...500	250...500	1 1	AF400-30-11	1SFL577001R7111	12.000
250	700	400	650	-	24...60	1 1	AF460-30-11	1SFL597001R6811 (1)	12.000
				48...130	48...130	1 1	AF460-30-11	1SFL597001R6911	12.000
				100...250	100...250	1 1	AF460-30-11	1SFL597001R7011	12.000
				250...500	250...500	1 1	AF460-30-11	1SFL597001R7111	12.000
315	800	500	750	-	24...60	1 1	AF580-30-11	1SFL617001R6811 (1)	15.000
				48...130	48...130	1 1	AF580-30-11	1SFL617001R6911	15.000
				100...250	100...250	1 1	AF580-30-11	1SFL617001R7011	15.000
				250...500	250...500	1 1	AF580-30-11	1SFL617001R7111	15.000
400	1050	600	900	-	24...60	1 1	AF750-30-11	1SFL637001R6811 (1)	15.000
				48...130	48...130	1 1	AF750-30-11	1SFL637001R6911	15.000
				100...250	100...250	1 1	AF750-30-11	1SFL637001R7011	15.000
				250...500	250...500	1 1	AF750-30-11	1SFL637001R7111	15.000

(1) The connection polarities indicated close to the coil terminals must be respected: A1 for the positive pole and A2 for the negative pole.
 (2) Up to 850 V DC for AF580, AF750.

AF400 ... AF750 are equipped with low voltage inputs for control, for example by a PLC.

Control inputs

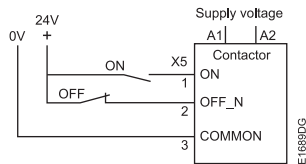

Main dimensions mm, inches

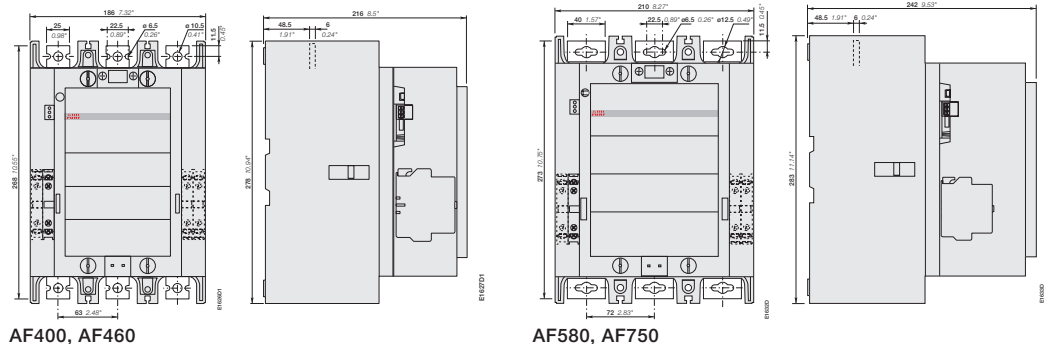

AF400, AF460

AF580, AF750

1SFC101013C0201

AF1250 ... AF2050 3-pole contactors

475 to 560 kW and 1250 to 2050 A AC-1

AC / DC operated with 1 N.O. + 1 N.C. auxiliary contacts



AF1250-30-11

1SFC101097F0001



AF1650-30-11

1SFC101028F0201

Description

AF1250 ... AF2050 contactors are mainly used for controlling power circuits up to 1000 V AC or 850 V DC.

These contactors are of the block type design with:

- 3 main poles
- control circuit: AC or DC operated with electronic coil interface accepting a wide control voltage range (e.g. 100...250 V AC and DC)
- can manage large control voltage variations
- only 4 coils for AF1250 to cover control voltages between 48...500 V 50/60 Hz and 24...500 V DC
- only 1 coil for AF1350 ... AF2050 to cover control voltages between 100...250 V 50/60 Hz and 100...250 V DC
- reduced panel energy consumption
- very distinct closing and opening
- can withstand short voltage dips and voltages sags (SEMI F47 conditions of use on request).
- built-in surge suppression
- add-on auxiliary contact blocks for side mounting and a wide range of accessories.

Ordering details

IEC		UL/CSA		Rated control circuit voltage		Auxiliary contacts fitted		Type	Order code	Weight
Rated operational power	Rated current $\theta \leq 40^\circ\text{C}$	3-phase motor rating	General use rating	Uc min. ... Uc max. (1)						Pkg (1 pce)
kW	A	hp	A	V 50/60 Hz	V DC					kg
-	1260	-	1210	-	24...60	1	1	AF1250-30-11	1SFL647001R6811 (1)	16.000
				48...130	48...130	1	1	AF1250-30-11	1SFL647001R6911	16.000
				100...250	100...250	1	1	AF1250-30-11	1SFL647001R7011	16.000
				250...500	250...500	1	1	AF1250-30-11	1SFL647001R7111	16.000
475	1350	800	1350	100...250	100...250	1	1	AF1350-30-11	1SFL657001R7011	34.000
560	1650	900	1650	100...250	100...250	1	1	AF1650-30-11	1SFL677001R7011	35.000
-	2050	-	2100	100...250	100...250	1	1	AF2050-30-11	1SFL707001R7011	35.000

(1) The connection polarities indicated close to the coil terminals must be respected: A1 for the positive pole and A2 for the negative pole.

AF1250 ... AF2050 are equipped with low voltage inputs for control, for example by a PLC.

Control inputs

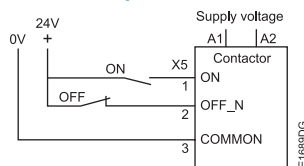

Main dimensions mm, inches

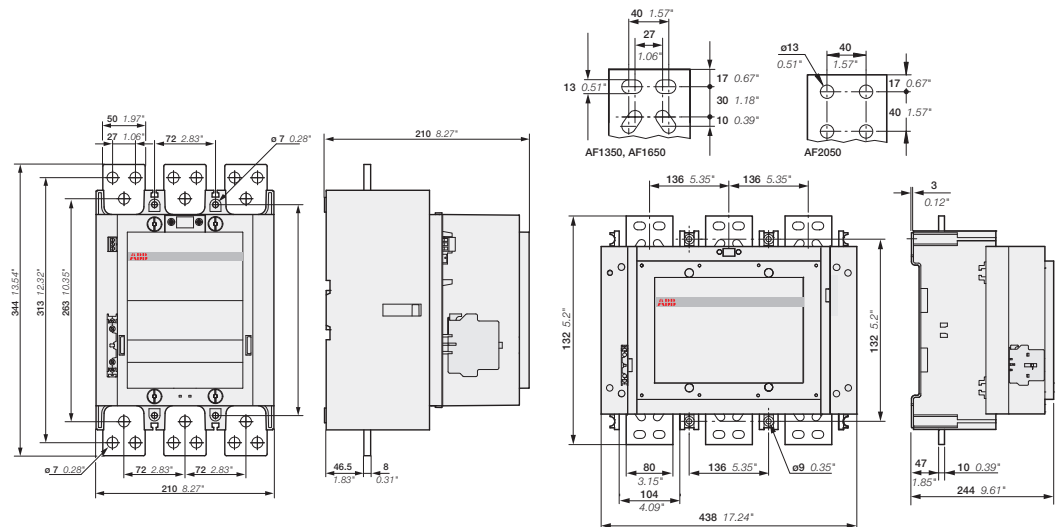

AF1250

AF1350 ... AF2050

1SFC101015C0201

A145 ... A300 and AF145 ... AF2050 3-pole contactors with 1 N.O. + 1 N.C. auxiliary contacts

Main accessories (other accessories available) AF185 shown on picture

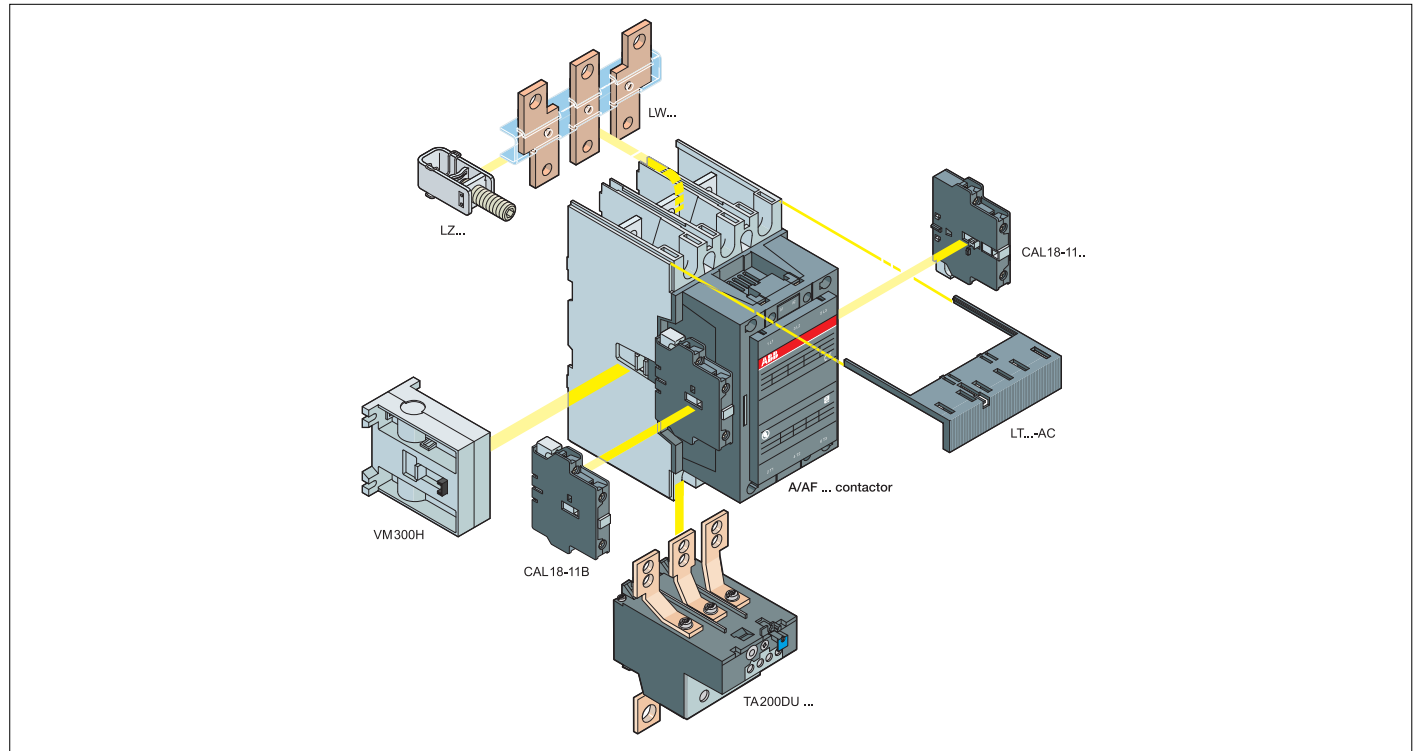

5

Main accessory fitting details

Contactor types	Main poles	Available auxiliary contacts	Side-mounted accessories			Mechanical interlock units	Mounting and positioning
			Add-on auxiliary contact blocks				
			CAL18-11, CAL18-11B (3)			(for two horizontal mounted contactors)	Factory mounted auxiliary contacts Add-on CAL18-11 auxiliary contacts Add-on CAL18-11B auxiliary contacts

Contactors + auxiliary contact blocks

A145 ... A300 AF145 ... AF2050	3	0	1	1	1 x CAL18-11	+	2 x CAL18-11B	-	
-----------------------------------	---	---	---	---	--------------	---	---------------	---	--

Contactors with mechanical interlocking + auxiliary contact blocks

A145 ... A185 AF145 ... AF185	3	0	1	1	2 x CAL18-11 (1)	+	3 x CAL18-11B (1)	+	VM...H (2)	
A210 ... A300 AF210 ... AF2050	3	0	1	1	2 x CAL18-11 (1)	+	4 x CAL18-11B (1)	+	VM...H (2)	

(1) Total number of auxiliary contact blocks for the two contactors. (2) Interlock type, according to the contactor ratings (see "Accessories").
 (3) The CEL18-... auxiliary contact blocks can replace the CAL18-11 and CAL18-11B. Though, no auxiliary contact block can be mounted outside the CEL18-...

Overload relays fitting details

Contactor types	Thermal overload relays	Electronic overload relays
A145, A185	TA200DU (80...200 A) (4)	E200DU (60...200 A) (4)
A210, A300	TA450DU (100...310 A) (4) or TA450SU (130...310 A) (5)	E320DU (100...320 A) (4)
AF400, AF460	-	E500DU (150...500 A) (5)
AF580, AF750	-	E800DU (250...800 A) (5)
AF1350, AF1650	-	E1250DU (375...1250 A) (5)

The addition of a thermal or electronic overload relay on the contactor does not prevent fitting of many other accessories as shown in "Main accessory fitting details" table.

(4) Direct mounting - No kit required.
 (5) Mounting kit required (see "Motor protection").

A145 ... A300 and AF145 ... AF2050 3-pole contactors

Main accessories



CAL18-11



VM300H

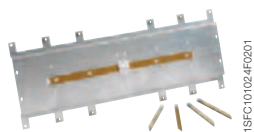

VM1650H



LT...AC

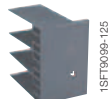

LT...AL



LT...AY



LW

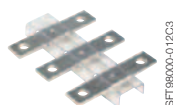

LX



LZ...



LZ...



LZ...

Ordering details (1)

For contactors	Auxiliary contacts	Type	Order code	Pkg qty	Weight (1 pce)
					kg

Side-mounted instantaneous auxiliary contact blocks

A145 ... A300 and AF145 ... AF2050	1	1	CAL18-11	1SFN010720R1011	2	0.050
	1	1	CAL18-11B	1SFN010720R3311	2	0.050

Mechanical interlock unit for two horizontal mounted contactors

A145 ... A300	VM300H	1SFN034700R1000	1	0.150
A210 ... A300	VM300/460H	1SFN035100R1000	1	0.150
AF400 ... AF1250	VM750H	1SFN035700R1000	1	0.200
AF1350 ... AF2050	VM1650H	1SFN036503R1000	1	6.000

Terminal shrouds

A145 ... A185 with connectors	LT185-AC	1SFN124701R1000	2	0.050
A145 ... A185 with lugs	LT185-AL	1SFN124703R1000	2	0.220
A145 ... A185 with short bar LY185 or between A145 and TA200DU or between A185 and TA200DU	LT185-AY	1SFN124704R1000	1	0.050
A210 ... A300 with connectors	LT300-AC	1SFN125101R1000	2	0.070
A210 ... A300 with lugs	LT300-AL	1SFN125103R1000	2	0.280
A210 ... A300 with short bar LY300	LT300-AY	1SFN125104R1000	1	0.075
AF400 ... AF460 with connectors	LT460-AC	1SFN125701R1000	2	0.100
AF400 ... AF460 with lugs	LT460-AL	1SFN125703R1000	2	0.800
AF580 ... AF750 with connectors	LT750-AC	1SFN126101R1000	2	0.120
AF580 ... AF750 with lugs	LT750-AL	1SFN126103R1000	2	0.825

Terminal enlargements

For contactors	Dimensions		Type	Order code	Pkg qty	Weight (1 pce) kg
	hole Ø mm	bar mm				
A145, A185	10.5	20 x 5	LW185	1SFN074707R1000	1	0.250
A210 ... A300	10.5	25 x 5	LW300	1SFN075107R1000	1	0.450
AF400, AF460	10.5	25 x 5	LW460	1SFN075707R1000	1	0.730
AF580, AF750	13	40 x 6	LW750	1SFN076107R1000	1	1.230
AF1250	13	50 x 10	LW1250	1SFN076407R1000	1	2.000

Terminal extension

A145, A185	8.5	20 x 5	LX185	1SFN074710R1000	1	0.250
A210 ... A300	10.5	20 x 5	LX300	1SFN075110R1000	1	0.350
AF400, AF460	10.5	25 x 5	LX460	1SFN075710R1000	1	0.500
AF580, AF750	13	40 x 6	LX750	1SFN076110R1000	1	0.850

(1) For each contactor type, refer to "Main accessory fitting details" table.

Ordering details (1)

Cables	For contactors	Cable cross section	Type	Order code	Pkg qty	Weight (1 pce) kg
		mm ²				

Connector terminals

Single Cu	A145, A185	6...185	-	1SDA023354R0001	3	0.200
	A210 ... A300	16...240	-	1SDA023368R0001	3	0.400
Single Al & Cu	A145, A185	35...95	-	1SDA023356R0001	3	0.100
	A145, A185	25...150	-	1SDA023357R0001	3	0.100
	A210 ... A300	120...240	-	1SDA023370R0001	3	0.200
	A210 ... A300	2 x (95...120)	LZ185-2C/120	1SFN074709R1000	3	0.300
Double Cu	A145, A185	2 x (50...120)	-	1SDA025766R0001	3	0.400
	A210 ... A300	2 x (120...240)	-	1SDA023380R0001	3	0.110
Double Al & Cu	AF400 ... AF750	2 x (120...240)	-	1SDA023380R0001	3	0.110
	AF400 ... AF750	3 x (70...185)	-	1SDA023384R0001	3	0.265
Triple Al & Cu	AF400 ... AF750	3 x (70...185)	-	1SDA023384R0001	3	0.265
Multi Al & Cu	AF1350, AF1650	4 x (120...240)	-	1SDA023387R0001	3	0.400

(1) For each contactor type, refer to "Main accessory fitting details" table.
Note: Connectors provided for the A... contactors can be used for the AF types.

AF09 ... AF38 3-pole contactors

Technical data

Main pole - Utilization characteristics according to IEC

Contactor types	AC / DC operated	AF09	AF12	AF16	AF26	AF30	AF38
Standards		IEC 60947-1 / 60947-4-1 and EN 60947-1 / 60947-4-1					
Rated operational voltage U_e max.		690 V					
Rated frequency (without derating)		50 / 60 Hz					
Conventional free-air thermal current I_{th}							
acc. to IEC 60947-4-1, open contactors, $\theta \leq 40^\circ\text{C}$		35 A	35 A	35 A	50 A	50 A	50 A
With conductor cross-sectional area		6 mm ²	6 mm ²	6 mm ²	10 mm ²	10 mm ²	10 mm ²
AC-1 Utilization category							
For air temperature close to contactor							
I_e / Rated operational current AC-1	$\theta \leq 40^\circ\text{C}$	25 A	28 A	30 A	45 A	50 A	50 A
U_e max. $\leq 690\text{ V}$, 50/60 Hz	$\theta \leq 60^\circ\text{C}$	25 A	28 A	30 A	40 A	42 A	42 A
	$\theta \leq 70^\circ\text{C}$	22 A	24 A	26 A	32 A	37 A	37 A
With conductor cross-sectional area		4 mm ²	6 mm ²	6 mm ²	10 mm ²	10 mm ²	10 mm ²
AC-3 Utilization category							
For air temperature close to contactor $\theta \leq 60^\circ\text{C}$							
I_e / Max. rated operational current AC-3 (1)							
	220-230-240 V	9 A	12 A	18 A	26 A	33 A	40 A
	380-400 V	9 A	12 A	18 A	26 A	32 A	38 A
	415 V	9 A	12 A	18 A	26 A	32 A	38 A
	440 V	9 A	12 A	18 A	26 A	32 A	38 A
	500 V	9.5 A	12.5 A	15 A	23 A	28 A	33 A
	690 V	7 A	9 A	10.5 A	17 A	21 A	24 A
Rated operational power AC-3 (1)							
	220-230-240 V	2.2 kW	3 kW	4 kW	6.5 kW	9 kW	11 kW
	380-400 V	4 kW	5.5 kW	7.5 kW	11 kW	15 kW	18.5 kW
	415 V	4 kW	5.5 kW	9 kW	11 kW	15 kW	18.5 kW
	440 V	4 kW	5.5 kW	9 kW	15 kW	18.5 kW	22 kW
	500 V	5.5 kW	7.5 kW	9 kW	15 kW	18.5 kW	22 kW
	690 V	5.5 kW	7.5 kW	9 kW	15 kW	18.5 kW	22 kW
Rated making capacity AC-3		10 x I_e AC-3 acc. to IEC 60947-4-1					
Rated breaking capacity AC-3		8 x I_e AC-3 acc. to IEC 60947-4-1					
AC-8a Utilization category							
(without thermal overload relay - U_e 400 V 50/60 Hz - $\theta \leq 40^\circ\text{C}$)							
I_e / Rated operational current AC-8a		12 A	16 A	22 A	30 A	40 A	50 A
Rated operational power AC-8a		5.5 kW	7.5 kW	11 kW	15 kW	20 kW	25 kW
Short-circuit protection device for contactors							
without thermal overload relay - Motor protection excluded (2)							
$U_e \leq 500\text{ V AC}$ - gG type fuse		25 A	32 A	32 A	50 A	63 A	63 A
Rated short-time withstand current I_{cw}							
at 40 °C ambient temperature, in free air from a cold state							
	1 s	300 A	300 A	300 A	700 A	700 A	700 A
	10 s	150 A	150 A	150 A	350 A	350 A	350 A
	30 s	80 A	80 A	80 A	225 A	225 A	225 A
	1 min	60 A	60 A	60 A	150 A	150 A	150 A
	15 min	35 A	35 A	35 A	50 A	50 A	50 A
Maximum breaking capacity							
$\cos \varphi = 0.45$							
	at 440 V	250 A	250 A	250 A	500 A	500 A	500 A
	at 690 V	106 A	106 A	106 A	200 A	200 A	200 A
Power dissipation per pole							
	I_e / AC-1	0.8 W	1 W	1.2 W	1.8 W	2.4 W	2.4 W
	I_e / AC-3	0.1 W	0.2 W	0.35 W	0.6 W	0.9 W	1.3 W
Max. electrical switching frequency							
	AC-1	600 cycles/h					
	AC-3	1200 cycles/h					
	AC-2, AC-4	300 cycles/h				150 cycles/h	

(1) For the corresponding kW/A or hp/A values of 1500 r.p.m., 50 Hz or 1800 r.p.m., 60 Hz, 3-phase motors, see "Motor rated operational powers and currents".

(2) For the protection of motor starters against short circuits, see "Coordination with short-circuit protection devices".

A40 ... A110, AL, AE, TAL, TAE and AF50 ... AF110 3-pole contactors

Technical data

Main pole - Utilization characteristics according to IEC

Contactor types	AC operated	A40	A50	A63	A75	A95	A110
	DC operated	AL40	AE50	AE63	AE75	–	–
		TAL40	TAE50	–	TAE75	–	–
	AC / DC operated	–	AF50	AF63	AF75	AF95	AF110
Standards	IEC 60947-1 / 60947-4-1 and EN 60947-1 / 60947-4-1						
Rated operational voltage Ue max.	690 V		1000 V (690 V for AF. contactors)			1000 V	
Rated frequency (without derating)	50/60 Hz						
Conventional free-air thermal current Ith acc. to IEC 60947-4-1, open contactors, $\theta \leq 40^\circ\text{C}$		65 A	100 A	125 A	125 A	145 A	160 A
With conductor cross-sectional area		16 mm ²	35 mm ²	50 mm ²	50 mm ²	50 mm ²	70 mm ²
AC-1 Utilization category For air temperature close to contactor							
Ie / Rated operational current AC-1	$\theta \leq 40^\circ\text{C}$	60 A	100 A	115 A	125 A	145 A	160 A
Ue max. $\leq 690\text{ V}$, 50/60 Hz	$\theta \leq 55^\circ\text{C}$	60 A	85 A	95 A	105 A	135 A	145 A
	$\theta \leq 70^\circ\text{C}$ (3)	42 A	70 A	80 A	85 A	115 A	130 A
With conductor cross-sectional area		16 mm ²	35 mm ²	50 mm ²	50 mm ²	50 mm ²	70 mm ²
AC-3 Utilization category For air temperature close to contactor $\theta \leq 55^\circ\text{C}$							
Ie / Max. rated operational current AC-3 (1)							
	220-230-240 V	40 A	53 A	65 A	75 A	96 A	110 A
	380-400 V	37 A	50 A	65 A	75 A	96 A	110 A
	415 V	37 A	50 A	65 A	75 A	96 A	110 A
	440 V	37 A	45 A	65 A	70 A	93 A	100 A
	500 V	33 A	45 A	55 A	65 A	80 A	100 A
	690 V	25 A (4)	35 A	43 A	46 A	65 A	82 A
	1000 V	–	23 A (6)	25 A (6)	28 A (6)	30 A	30 A
Rated operational power AC-3 (1)							
	220-230-240 V	11 kW	15 kW	18.5 kW	22 kW	25 kW	30 kW
	380-400 V	18.5 kW	22 kW	30 kW	37 kW	45 kW	55 kW
	415 V	18.5 kW	25 kW	37 kW	40 kW	55 kW	59 kW
	440 V	22 kW	25 kW	37 kW	40 kW	55 kW	59 kW
	500 V	22 kW	30 kW	37 kW	45 kW	55 kW	59 kW
	690 V	22 kW (4)	30 kW	37 kW	40 kW	55 kW	75 kW
	1000 V	–	30 kW (6)	33 kW (6)	37 kW (6)	40 kW	40 kW
Rated making capacity AC-3	10 x Ie AC-3 acc. to IEC 60947-4-1						
Rated breaking capacity AC-3	8 x Ie AC-3 acc. to IEC 60947-4-1						
AC-8a Utilization category (without thermal overload relay - Ue 400 V 50/60 Hz - $\theta \leq 40^\circ\text{C}$)							
Ie / Rated operational current AC-8a		50 A	63 A	85 A	95 A	120 A	140 A
Rated operational power AC-8a		22 kW	30 kW	45 kW	45 kW	55 kW	75 kW
Short-circuit protection device for contactors without thermal overload relay - Motor protection excluded (2)							
Ue $\leq 500\text{ V AC}$ - gG type fuse		63 A	100 A	125 A	160 A	160 A	200 A
Rated short-time withstand current Icw at 40 °C ambient temperature, in free air from a cold state	1 s	600 A	1000 A			1320 A	
	10 s	400 A	650 A			800 A	
	30 s	225 A	370 A			500 A	
	1 min	150 A	250 A			350 A	
	15 min	65 A	110 A	135 A	135 A	160 A	175 A
Maximum breaking capacity cos $\phi = 0.45$ (cos $\phi = 0.35$ for Ie > 100 A)	at 440 V	820 A (5)	1300 A			1160 A	
	at 690 V	340 A (5)	630 A			800 A	
Power dissipation per pole	Ie / AC-1	3 W	5 W	6.5 W	7 W	6.5 W	7.5 W
	Ie / AC-3	1.3 W	1.3 W	1.5 W	2 W	2.7 W	3.6 W
Max. electrical switching frequency	AC-1	600 cycles/h	600 cycles/h (300 for AF., AE., TAE.)			300 cycles/h	
	AC-3	1200 cycles/h	600 cycles/h (300 for AF., AE., TAE.)			300 cycles/h	
	AC-2, AC-4	300 cycles/h	150 cycles/h				

- (1) For the corresponding kW/A or hp/A values of 1500 r.p.m. 50 Hz or 1800 r.p.m. 60 Hz, 3-phase motors, see "Motor rated operational powers and currents".
 (2) For the protection of motor starters against short circuits, see "Coordination with short-circuit protection devices".
 (3) Unauthorized for TAL..., TAE... contactors.
 (4) AC-3, 690 V values for AL40 and TAL40 contactors: 18.5 kW, Ie = 21 A.
 (5) Max. breaking capacity for AL40 and TAL40 contactors: 470 A at 440 V, 175 A at 690 V.
 (6) AF contactors excluded.

A145 ... A300 and AF145 ... AF300 3-pole contactors

Technical data

Main pole - Utilization characteristics according to IEC

Contactor types	AC operated					
	AC / DC operated	A145	A185	A210	A260	A300
Standards		IEC 60947-1 / 60947-4-1 and EN 60947-1 / 60947-4-1				
Rated operational voltage U_e max.		1000 V		690 V		
Rated frequency (without derating)		50/60 Hz				
Conventional free-air thermal current I_{th} acc. to IEC 60947-4-1, open contactors, $\theta \leq 40^\circ\text{C}$		250 A	275 A	350 A	400 A	500 A (4)
With conductor cross-sectional area (3)		120 mm ²	150 mm ²	185 mm ²	240 mm ²	300 mm ² (4)
AC-1 Utilization category For air temperature close to contactor						
I_e / Rated operational current AC-1 U_e max. ≤ 690 V, 50/60 Hz	$\theta \leq 40^\circ\text{C}$	250 A	275 A	350 A	400 A	500 A (4)
	$\theta \leq 55^\circ\text{C}$	230 A	250 A	300 A	350 A	400 A (4)
	$\theta \leq 70^\circ\text{C}$	180 A	180 A	240 A	290 A	325 A (4)
I_e / Rated operational current AC-1 U_e max. ≤ 1000 V, 50/60 Hz	$\theta \leq 40^\circ\text{C}$	180 A	200 A	–	–	–
	$\theta \leq 55^\circ\text{C}$	180 A	200 A	–	–	–
	$\theta \leq 70^\circ\text{C}$	180 A	180 A	–	–	–
With conductor cross-sectional area		120 mm ²	150 mm ²	185 mm ²	240 mm ²	300 mm ² (4)
AC-3 Utilization category For air temperature close to contactor $\theta \leq 55^\circ\text{C}$						
I_e / Max. rated operational current AC-3 (1)						
	220-230-240 V	145 A	185 A	210 A	260 A	305 A
	380-400 V	145 A	185 A	210 A	260 A	305 A
	415 V	145 A	185 A	210 A	260 A	300 A
	440 V	145 A	185 A	210 A	240 A	280 A
	500 V	145 A	170 A	210 A	240 A	280 A
	690 V	120 A	170 A	210 A	220 A	280 A
	1000 V	80 A	95 A	–	–	–
Rated operational power AC-3 (1)						
	220-230-240 V	45 kW	55 kW	59 kW	80 kW	90 kW
	380-400 V	75 kW	90 kW	110 kW	140 kW	160 kW
	415 V	75 kW	90 kW	110 kW	140 kW	160 kW
	440 V	75 kW	90 kW	110 kW	140 kW	160 kW
	500 V	90 kW	110 kW	132 kW	180 kW	200 kW
	690 V	110 kW	132 kW	160 kW	200 kW	250 kW
	1000 V	110 kW	132 kW	–	–	–
Rated making capacity AC-3		10 x I_e AC-3 acc. to IEC 60947-4-1				
Rated breaking capacity AC-3		8 x I_e AC-3 acc. to IEC 60947-4-1				
Short-circuit protection device for contactors without thermal overload relay - Motor protection excluded (2)						
$U_e \leq 500$ V AC - gG type fuse		315 A	355 A	400 A	500 A	500 A
Rated short-time withstand current I_{cw} at 40°C ambient temperature, in free air from a cold state	1 s	1800 A	2000 A	2500 A	3500 A	3500 A
	10 s	1200 A	1500 A	1700 A	2400 A	2400 A
	30 s	800 A	1000 A	1200 A	1500 A	1500 A
	1 min	600 A	800 A	1000 A	1100 A	1100 A
	15 min	280 A	320 A	400 A	500 A	500 A
Maximum breaking capacity $\cos \varphi = 0.45$	at 440 V	1500 A	2000 A	2300 A	2600 A	3000 A
($\cos \varphi = 0.35$ for $I_e > 100$ A)	at 690 V	1200 A	1600 A	2000 A	2400 A	2500 A
Power dissipation per pole	I_e / AC-1	13 W	16 W	18 W	25 W	32 W
	I_e / AC-3	5 W	8 W	9 W	14 W	18 W
Max. electrical switching frequency	AC-1	300 cycles/h			300 cycles/h	
	AC-3	300 cycles/h			300 cycles/h	
	AC-2, AC-4	150 cycles/h			150 cycles/h	



3-phase motors



1500 r.p.m. 50 Hz
1800 r.p.m. 60 Hz
3-phase motors

(1) For the corresponding kW/A or hp/A values of 1500 r.p.m. 50 Hz or 1800 r.p.m. 60 Hz, 3-phase motors, see "Motor rated operational powers and currents".

(2) For the protection of motor starters against short circuits, see "Coordination with short-circuit protection devices".

(3) Conductors with preparation.

(4) Use terminal extension / enlargement pieces (LX 300 / LW 300).

AF400 ... AF2050 3-pole contactors

Technical data

Main pole - Utilization characteristics according to IEC

Contactor types	AC / DC operated	AF400	AF460	AF580	AF750	AF1250	AF1350	AF1650	AF2050
Standards		IEC 60947-1 / 60947-4-1 and EN 60947-1 / 60947-4-1							
Rated operational voltage U _e max.		1000 V							
Rated frequency (without derating)		50/60 Hz							
Conventional free-air thermal current I _{th}									
acc. to IEC 60947-4-1, open contactors, $\theta \leq 40^\circ\text{C}$		600 A	700 A	800 A	1050 A	1260 A	1350 A	1650 A	2050 A
With conductor cross-sectional area (3)		2x185 mm ²	2x240 mm ²	2x240 mm ²	800 mm ² (4)	1000 mm ² (4)	1000 mm ² (5)	1500 mm ² (5)	2000 mm ² (5)
AC-1 Utilization category									
For air temperature close to contactor									
I_e / Rated operational current AC-1	$\theta \leq 40^\circ\text{C}$	600 A	700 A	800 A	1050 A	1260 A	1350 A	1650 A	2050 A
U _e max. $\leq 690\text{ V}$, 50/60 Hz	$\theta \leq 55^\circ\text{C}$	500 A	600 A	700 A	875 A	1040 A	1150 A	1450 A	1750 A
	$\theta \leq 70^\circ\text{C}$	400 A	480 A	580 A	720 A	875 A	1000 A	1270 A	1500 A
I_e / Rated operational current AC-1	$\theta \leq 40^\circ\text{C}$	600 A	700 A	800 A	1000 A	1260 A	1350 A	1650 A	2050 A
U _e max. $\leq 1000\text{ V}$, 50/60 Hz	$\theta \leq 55^\circ\text{C}$	500 A	600 A	700 A	875 A	1040 A	1150 A	1450 A	1750 A
	$\theta \leq 70^\circ\text{C}$	400 A	480 A	580 A	720 A	875 A	1000 A	1270 A	1500 A
With conductor cross-sectional area		2x185 mm ²	2x240 mm ²	2x240 mm ²	800 mm ² (4)	1000 mm ² (4)	1000 mm ² (5)	1500 mm ² (5)	2000 mm ² (5)
AC-3 Utilization category									
For air temperature close to contactor $\theta \leq 55^\circ\text{C}$									
I_e / Max. rated operational current AC-3 (1)									
	220-230-240 V	400 A	460 A	580 A	750 A	–	860 A	1050 A	–
	380-400 V	400 A	460 A	580 A	750 A	–	860 A	1050 A	–
	415 V	400 A	460 A	580 A	750 A	–	860 A	1050 A	–
	440 V	400 A	460 A	580 A	750 A	–	860 A	1050 A	–
	500 V	400 A	460 A	580 A	750 A	–	800 A	950 A	–
	690 V	350 A	400 A	500 A	650 A	–	800 A	950 A	–
	1000 V	155 A	200 A	250 A	300 A	–	–	–	–
Rated operational power AC-3 (1)									
	220-230-240 V	110 kW	132 kW	160 kW	220 kW	–	257 kW	315 kW	–
	380-400 V	200 kW	250 kW	315 kW	400 kW	–	475 kW	560 kW	–
	415 V	220 kW	250 kW	355 kW	425 kW	–	500 kW	600 kW	–
	440 V	220 kW	250 kW	355 kW	450 kW	–	560 kW	670 kW	–
	500 V	250 kW	315 kW	400 kW	520 kW	–	560 kW	700 kW	–
	690 V	315 kW	355 kW	500 kW	600 kW	–	750 kW	900 kW	–
	1000 V	220 kW	280 kW	355 kW	400 kW	–	–	–	–
Rated making capacity AC-3		10 x I _e AC-3 acc. to IEC 60947-4-1							
Rated breaking capacity AC-3		8 x I _e AC-3 acc. to IEC 60947-4-1							
Short-circuit protection device for contactors									
without thermal overload relay - Motor protection excluded (2)									
U _e $\leq 500\text{ V AC}$ - gG type fuse		630 A	800 A	1000 A	1000 A	Please consult us for coordination with circuit-breaker			
Rated short-time withstand current I_{sw}									
at 40 °C ambient temperature,	1 s	4600 A	4600 A	7000 A	7000 A	8000 A	10000 A	12000 A	12000 A
in free air from a cold state	10 s	4400 A	4400 A	6400 A	6400 A	7200 A	8000 A	10000 A	10000 A
	30 s	3100 A	3100 A	4500 A	4500 A	5200 A	6000 A	7500 A	7500 A
	1 min	2500 A	2500 A	3500 A	3500 A	4000 A	4500 A	5500 A	5500 A
	15 min	840 A	840 A	1300 A	1300 A	1500 A	1600 A	2200 A	2200 A
Maximum breaking capacity									
cos $\phi = 0.45$	at 440 V	4000 A	5000 A	6000 A	7500 A	–	10000 A	12000 A	8400 A
(cos $\phi = 0.35$ for I _e > 100 A)	at 690 V	3500 A	4500 A	5000 A	7000 A	–	–	–	–
Power dissipation per pole	I _e / AC-1	30 W	42 W	32 W	50 W	80 W	80 W	80 W	125 W
	I _e / AC-3	16 W	21 W	17 W	28 W	–	50 W	50 W	–
Max. electrical switching frequency									
	AC-1	300 cycles/h		300 cycles/h		300 cycles/h		60 cycles/h	
	AC-3	300 cycles/h		300 cycles/h		–		60 cycles/h	
	AC-2, AC-4	60 cycles/h		60 cycles/h		–		60 cycles/h	



3-phase motors



1500 r.p.m. 50 Hz
1800 r.p.m. 60 Hz
3-phase motors

(1) For the corresponding kW/A or hp/A values of 1500 r.p.m, 50 Hz or 1800 r.p.m, 60 Hz, 3-phase motors, see "Motor rated operational powers and currents".

(2) For the protection of motor starters against short circuits, see "Coordination with short-circuit protection devices".

(3) Conductors with preparation.

(4) Max. connection bar width 50 mm.

(5) Max. connection bar width 100 mm.

AF09 ... AF38 3-pole contactors

Technical data

Main pole - Utilization characteristics according to UL / NEMA / CSA

Contactor types	AC / DC operated	AF09	AF12	AF16	AF26	AF30	AF38
Standards		UL 508, CSA C22.2 N°14					
Max. operational voltage		600 V					
NEMA size		00	0	-	1	-	-
NEMA continuous amp rating	Thermal current	9 A	18 A		27 A		
NEMA maximum horse power ratings 1-phase, 60 Hz							
	115 V AC	1/3 hp	1 hp		2 hp		
	230 V AC	1 hp	2 hp		3 hp		
NEMA maximum horse power ratings 3-phase, 60 Hz							
	200 V AC	1-1/2 hp	3 hp		7-1/2 hp		
	230 V AC	1-1/2 hp	3 hp		7-1/2 hp		
	460 V AC	2 hp	5 hp		10 hp		
	575 V AC	2 hp	5 hp		10 hp		
UL / CSA general use rating							
600 V AC		25 A	28 A	30 A	45 A	50 A	50 A
With conductor cross-sectional area		AWG 10	AWG 10	AWG 10	AWG 8	AWG 8	AWG 8
UL / CSA maximum 1-phase motor rating							
Full load current	120 V AC	13.8 A	16 A	20 A	24 A	24 A	24 A
	240 V AC	10 A	12 A	17 A	17 A	28 A	28 A
Horse power rating	120 V AC	3/4 hp	1 hp	1-1/2 hp	2 hp	2 hp	2 hp
	240 V AC	1-1/2 hp	2 hp	3 hp	3 hp	5 hp	5 hp
UL / CSA maximum 3-phase motor rating							
Full load current (1)	200-208 V AC	7.8 A	11 A	17.5 A	25.3 A	32.2 A	32.2 A
	220-240 V AC	6.8 A	9.6 A	15.2 A	22 A	28 A	28 A
	440-480 V AC	7.6 A	11 A	14 A	21 A	27 A	27 A
	550-600 V AC	9 A	11 A	17 A	22 A	27 A (2)	27 A (2)
Horse power rating (1)	200-208 V AC	2 hp	3 hp	5 hp	7-1/2 hp	10 hp	10 hp
	220-240 V AC	2 hp	3 hp	5 hp	7-1/2 hp	10 hp	10 hp
	440-480 V AC	5 hp	7-1/2 hp	10 hp	15 hp	20 hp	20 hp
	550-600 V AC	7-1/2 hp	10 hp	15 hp	20 hp	25 hp (2)	25 hp (2)
Short-circuit protection device for contactors							
without thermal overload relay - Motor protection excluded							
Fuse rating		60 A	60 A	60 A	150 A	150 A	150 A
Fuse type, 600 V		NTD					
Max. electrical switching frequency							
For general use		600 cycles/h					
For motor use		1200 cycles/h					

(1) For the corresponding kW/A or hp/A values of 1500 r.p.m, 50 Hz or 1800 r.p.m, 60 Hz, 3-phase motors, see "Motor rated operational powers and currents".

(2) For contactors produced since week 49-2011.

General technical data

Contactor types	AC / DC operated	AF09	AF12	AF16	AF26	AF30	AF38
Rated insulation voltage Ui		690 V					
acc. to IEC 60947-4-1		600 V					
acc. to UL / CSA		6 kV					
Rated impulse withstand voltage Uimp.		Devices complying with IEC 60947-1 / EN 60947-1 - Environment A					
Electromagnetic compatibility		-60...+80 °C					
Ambient air temperature close to contactor		Category B according to IEC 60947-1 Annex Q					
Operation	Fitted with thermal overload relay	-25...+60 °C					
	Without thermal overload relay	-40...+70 °C					
Storage		-60...+80 °C					
Climatic withstand		3000 m					
Maximum operating altitude (without derating)		10 millions operating cycles					
Mechanical durability		3600 cycles/h					
Number of operating cycles							
Max. switching frequency							
Shock withstand							
acc. to IEC 60068-2-27 and EN 60068-2-27							
Mounting position 1							
Shock direction		1/2 sinusoidal shock for 11 ms: no change in contact position, closed or open position					
A		30 g					
B1		25 g closed position / 5 g open position					
B2		15 g					
C1		25 g					
C2		25 g					
Vibration withstand		5...300 Hz					
acc. to IEC 60068-2-6		4 g closed position / 2 g open position					

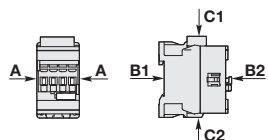

A40 ... A110, AL, AE, TAL, TAE and AF50 ... AF110 3-pole contactors

Technical data

Main pole - Utilization characteristics according to UL / NEMA / CSA

Contactor types	AC operated	A40	A50	A63	A75	A95	A110
	DC operated	AL40, TAL40	AE50, TAE50	AE63	AE75, TAE75	-	-
	AC / DC operated	-	AF50	AF63	AF75	AF95	AF110
Standards		UL 508, CSA C22.2 N°14					
Max. operational voltage		600 V					
NEMA size		-	2	-	3	-	-
NEMA continuous amp rating	Thermal current	-	45 A	-	90 A	-	-
NEMA maximum horse power ratings 1-phase, 60 Hz							
	115 V AC	-	3 hp	-	-	-	-
	230 V AC	-	7-1/2	-	-	-	-
NEMA maximum horse power ratings 3-phase, 60 Hz							
	200 V AC	-	10 hp	-	25 hp	-	-
	230 V AC	-	15 hp	-	30 hp	-	-
	460 V AC	-	25 hp	-	50 hp	-	-
	575 V AC	-	25 hp	-	50 hp	-	-
UL / CSA general use rating							
600 V AC		60 A	80 A	90 A	105 A	125 A	150 A
With conductor cross-sectional area		AWG 6	AWG 4	AWG 3	AWG 2	AWG 1	AWG 1/0
UL / CSA maximum 1-phase motor rating							
Full load current	120 V AC	34 A	34 A	56 A	80 A	80 A	100 A
	240 V AC	40 A	40 A	50 A	68 A	88 A	110 A
Horse power rating	120 V AC	3 hp	3 hp	5 hp	7.5 hp	7.5 hp	10 hp
	240 V AC	7.5 hp	7.5 hp	10 hp	15 hp	20 hp	25 hp
UL / CSA maximum 3-phase motor rating							
Full load current (1)	200-208 V AC	32.2 A	48.3 A	62.1 A	78.2 A	92 A	92 A
	220-240 V AC	42 A	54 A	68 A	80 A	80 A	104 A
	440-480 V AC	40 A	52 A	77 A	77 A	77 A	96 A
	550-600 V AC	41 A	52 A	77 A	77 A	77 A	99 A
Horse power rating (1)	200-208 V AC	10 hp	15 hp	20 hp	25 hp	30 hp	30 hp
	220-240 V AC	15 hp	20 hp	25 hp	30 hp	30 hp	40 hp
	440-480 V AC	30 hp	40 hp	60 hp	60 hp	60 hp	75 hp
	550-600 V AC	40 hp	50 hp	75 hp	75 hp	75 hp	100 hp
Short-circuit protection device for contactors							
without thermal overload relay - Motor protection excluded							
Fuse rating		150 A	175 A	200 A	200 A	200 A	200 A
Fuse type, 600 V		FRS-R		J			
Max. electrical switching frequency							
For general use		600 cycles/h	600 cycles/h (300 for AF.., AE..)			300 cycles/h	
For motor use		1200 cycles/h	600 cycles/h (300 for AF.., AE..)			300 cycles/h	

(1) For the corresponding kW/A or hp/A values of 1500 r.p.m, 50 Hz or 1800 r.p.m, 60 Hz, 3-phase motors, see "Motor rated operational powers and currents".

General technical data

Contactor types	AC operated	A40	A50	A63	A75	A95	A110
	DC operated	AL40, TAL40	AE50, TAE50	AE63	AE75, TAE75	-	-
	AC / DC operated	-	AF50	AF63	AF75	AF95	AF110
Rated insulation voltage Ui		1000 V					
acc. to IEC 60947-4-1		600 V					
acc. to UL		8 kV					
Rated impulse withstand voltage Uimp.		8 kV					
Electromagnetic compatibility		AF contactors complying with IEC 60947-1 / EN 60947-1 - Environment A					
Ambient air temperature close to contactor							
Operation	Fitted with thermal overload relay	-25...+55 °C					
	Without thermal overload relay	-40...+70 °C (55 °C max. for TAL.., and TAE.. contactor)					
Storage		-60...+80 °C					
Climatic withstand		acc. to IEC 60068-2-30 and 60068-2-11				acc. to IEC 60068-2-30	
		UTE C 63-100 specification II					
Maximum operating altitude (without derating)		3000 m					
Mechanical durability							
Number of operating cycles		10 millions operating cycles (5 millions for AE.. and TAE..)					
Max. switching frequency		3600 cycles/h (300 for AF contactors)					
Shock withstand							
acc. to IEC 60068-2-27 and EN 60068-2-27							
Mounting position 1							
	Shock direction	1/2 sinusoidal shock for 11 ms: no change in contact position, closed or open position (2)					
	A	20 g					
	B1	10 g closed position / 5 g open position					
	B2	15 g					
	C1	20 g					
	C2	20 g					
		For AL40, TAL40 A : 20 g closed position / 10 g open position B1 : 15 g closed position / 5 g open position B2 : 10 g closed position / 10 g open position C1 : 20 g closed position / 8 g open position C2 : 14 g closed position / 8 g open position					

(2) These values are not valid for rail mounting with contactors A95 ... A110 and AF95 ... AF110.

A145 ... A300 and AF145 ... AF300 3-pole contactors

Technical data

Main pole - Utilization characteristics according to UL / NEMA / CSA

Contactor types	AC operated	A145	A185	A210	A260	A300
	AC / DC operated	AF145	AF185	AF210	AF260	AF300
Standards		UL 508, CSA C22.2 N°14				
Max. operational voltage		600 V				
NEMA size		4	–	–	5	–
NEMA maximum horse power ratings 1-phase, 60 Hz	115 V AC	–	–	–	–	–
	230 V AC	–	–	–	–	–
NEMA maximum horse power ratings 3-phase, 60 Hz	200 V AC	40 hp	–	–	75 hp	–
	230 V AC	50 hp	–	–	100 hp	–
	460 V AC	100 hp	–	–	200 hp	–
	575 V AC	200 hp	–	–	200 hp	–
UL / CSA general use rating						
600 V AC		230 A	250 A	300 A	350 A	400 A
UL / CSA maximum 1-phase motor rating						
Full load current	240 V AC	–	–	–	–	–
Horse power rating	240 V AC	–	–	–	–	–
UL / CSA maximum 3-phase motor rating						
Full load current (1)	200-208 V AC	119.6 A	149.5 A	166.8 A	220.8 A	285.2 A
	220-240 V AC	130 A	145 A	192 A	248 A	248 A
	440-480 V AC	124 A	156 A	180 A	240 A	302 A
	550-600 V AC	125 A	144 A	192 A	242 A	289 A
	200-208 V AC	40 hp	50 hp	60 hp	75 hp	100 hp
Horse power rating (1)	220-240 V AC	50 hp	60 hp	75 hp	100 hp	100 hp
	440-480 V AC	100 hp	125 hp	150 hp	200 hp	250 hp
	550-600 V AC	125 hp	150 hp	200 hp	250 hp	300 hp
Short-circuit protection device for contactors						
without thermal overload relay - Motor protection excluded						
Fuse rating		300 A	400 A	800 A	800 A	800 A
Fuse type, 600 V		J/K5				
Max. electrical switching frequency						
For general use		300 cycles/h				
For motor use		300 cycles/h				

(1) For the corresponding kW/A or hp/A values of 1500 r.p.m, 50 Hz or 1800 r.p.m, 60 Hz, 3-phase motors, see "Motor rated operational powers and currents".

General technical data

Contactor types	AC operated	A145	A185	A210	A260	A300
	AC / DC operated	AF145	AF185	AF210	AF260	AF300
Rated insulation voltage Ui		1000 V				
acc. to IEC 60947-4-1		600 V				
acc. to UL		8 kV				
Rated impulse withstand voltage Uimp.		8 kV				
Electromagnetic compatibility		AF contactors complying with IEC 60947-1 / EN 60947-1 - Environment A				
Ambient air temperature close to contactor						
Operation	Fitted with thermal overload relay	-25 to +55 °C				
	Fitted with electronic overload relay	-25 to +70 °C				
	Without electronic overload relay	-40 to +70 °C				
Storage		-40 to +70 °C				
Climatic withstand		acc. to IEC 60068-2-30				
Maximum operating altitude (without derating)		3000 m				
Mechanical durability						
Number of operating cycles		5 millions operating cycles				
Max. switching frequency		3600 cycles/h (300 for AF... contactors)				
Shock withstand						
acc. to IEC 60068-2-27 and EN 60068-2-27						
Mounting position 1						
	Shock direction	1/2 sinusoidal shock for 30 ms: no change in contact position, closed or open position				
	A	5 g				
	B1	5 g				
	B2	5 g				
	C1	5 g				
	C2	5 g				

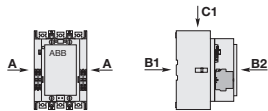

AF400 ... AF2050 3-pole contactors

Technical data

Main pole - Utilization characteristics according to UL / NEMA / CSA

Contactor types	AC / DC operated	AF400	AF460	AF580	AF750	AF1250	AF1350	AF1650	AF2050
Standards		UL 508, CSA C22.2 N°14							
Max. operational voltage		600 V							
NEMA size		-	6	-	7	-	8	-	-
NEMA maximum horse power ratings 1-phase, 60 Hz		-							
	115 V AC	-	-	-	-	-	-	-	-
	230 V AC	-	-	-	-	-	-	-	-
NEMA maximum horse power ratings 3-phase, 60 Hz		-							
	200 V AC	-	150 hp	-	-	-	-	-	-
	230 V AC	-	200 hp	-	300 hp	-	450 hp	-	-
	460 V AC	-	400 hp	-	600 hp	-	900 hp	-	-
	575 V AC	-	400 hp	-	600 hp	-	900 hp	-	-
UL / CSA general use rating		-							
600 V AC		550 A	650 A	750 A	900 A	1210 A	1350 A	1650 A	2100 A
UL / CSA maximum 1-phase motor rating		-							
Full load current	120 V AC	-	-	-	-	-	-	-	-
	240 V AC	-	-	-	-	-	-	-	-
Horse power rating	120 V AC	-	-	-	-	-	-	-	-
	240 V AC	-	-	-	-	-	-	-	-
UL / CSA maximum 3-phase motor rating		-							
Full load current (1)	200-208 V AC	358.8 A	414 A	552 A	692.3 A	-	954 A	1030 A	-
	220-240 V AC	360 A	480 A	604 A	722 A	-	954 A	1030 A	-
	440-480 V AC	414 A	477 A	590 A	722 A	-	954 A	1030 A	-
	550-600 V AC	382 A	472 A	578 A	672 A	-	944 A	1050 A	-
Horse power rating (1)	200-208 V AC	125 hp	150 hp	200 hp	250 hp	-	-	-	-
	220-240 V AC	150 hp	200 hp	250 hp	300 hp	-	400 A	450 hp	-
	440-480 V AC	350 hp	400 hp	500 hp	600 hp	-	800 A	900 hp	-
	550-600 V AC	400 hp	500 hp	600 hp	700 hp	-	1000 A	1150 hp	-
Short-circuit protection device for contactors		without thermal overload relay - Motor protection excluded							
Fuse rating		1000 A		1200 A		Please consult us for coordination with circuit-breaker			
Fuse type, 600 V		L							
Max. electrical switching frequency		-							
For general use		300 cycles/h				60 cycles/h			
For motor use		300 cycles/h				60 cycles/h			

(1) For the corresponding kW/A or hp/A values of 1500 r.p.m, 50 Hz or 1800 r.p.m, 60 Hz, 3-phase motors, see "Motor rated operational powers and currents".

General technical data

Contactor types	AC / DC operated	AF400	AF460	AF580	AF750	AF1250	AF1350	AF1650	AF2050
Rated insulation voltage Ui		-							
acc. to IEC 60947-4-1		1000 V							
acc. to UL		600 V							
Rated impulse withstand voltage Uimp.		8 kV							
Electromagnetic compatibility		AF contactors complying with IEC 60947-1 / EN 60947-1 - Environment A							
Ambient air temperature close to contactor		-							
Operation	Fitted with electronic overload relay	-25 to +70 °C							
	Without electronic overload relay	-40 to +70 °C							
Storage		-40 to +70 °C							
Climatic withstand		acc. to IEC 60068-2-30							
Maximum operating altitude (without derating)		3000 m							
Mechanical durability		-							
Number of operating cycles		3 millions operating cycles				0.5 million operating cycles			
Max. switching frequency		300 cycles/h				60 cycles/h			
Shock withstand		-							
acc. to IEC 60068-2-27 and EN 60068-2-27		-							
Mounting position 1		-							
Shock direction		1/2 sinusoidal shock for 30 ms: no change in contact position, closed or open position							
	A	5 g				-			
	B1	5 g				-			
	B2	5 g				-			
	C1	5 g				-			
	C2	5 g				-			

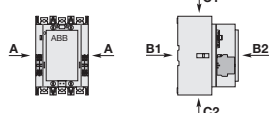

AF09 ... AF38 3-pole contactors

Technical data

Magnet system characteristics

Contactor types		AC / DC operated	AF09	AF12	AF16	AF26	AF30	AF38
Coil operating limits acc. to IEC 60947-4-1		AC supply	At $\theta \leq 60^\circ\text{C}$ $0.85 \times U_c \text{ min...} 1.1 \times U_c \text{ max.}$ At $\theta \leq 70^\circ\text{C}$ $0.85 \times U_c \text{ min...} U_c \text{ max.}$					
		DC supply	At $\theta \leq 60^\circ\text{C}$ $0.85 \times U_c \text{ min...} 1.1 \times U_c \text{ max.}$ At $\theta \leq 70^\circ\text{C}$ (AF) $0.85 \times U_c \text{ min...} U_c \text{ max.}$ - (AF..Z) $0.85 \times U_c \text{ min...} 1.1 \times U_c \text{ max.}$					
AC control voltage 50/60 Hz	Rated control circuit voltage U_c		24...500 V AC					
	Coil consumption	Average pull-in value	(AF) 50 VA - (AF..Z) 16 VA					
		Average holding value	(AF) 2.2 VA / 2 W - (AF..Z) 1.7 VA / 1.5 W					
DC control voltage	Rated control circuit voltage U_c		12...500 V DC					
	Coil consumption	Average pull-in value	(AF) 50 W - (AF..Z) 12...16 W					
		Average holding value	(AF) 2 W - (AF..Z) 1.7 W					
PLC-output control			(AF..Z) $\geq 500 \text{ mA}$ 24 V DC					
Drop-out voltage			$\leq 60\%$ of $U_c \text{ min.}$					
Voltage sag immunity acc. to SEMI F47-0706			(AF..Z) conditions of use on request					
Dips withstand $-20^\circ\text{C} \leq \theta \leq +60^\circ\text{C}$			(AF..Z) 22 ms average					
Operating time								
	Between coil energization and:	N.O. contact closing	40...95 ms					
		N.C. contact opening	38...90 ms					
	Between coil de-energization and:	N.O. contact opening	11...95 ms					
		N.C. contact closing	13...98 ms					

Mounting characteristics and conditions for use

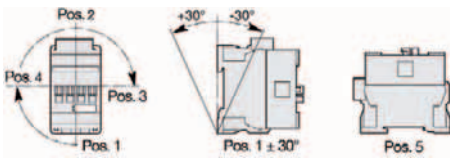
Contactor types		AC / DC operated	AF09	AF12	AF16	AF26	AF30	AF38
Mounting positions								
			Max. N.C. built-in and add-on N.C. auxiliary contacts: see accessory fitting details for a 3-pole contactor AF09 ... AF38					
Mounting distances			The contactors can be assembled side by side					
Fixing	On rail according to IEC 60715, EN 60715		35 x 7.5 mm or 35 x 15 mm					
	By screws (not supplied)		2 x M4 screws placed diagonally					

A40 ... A110 3-pole contactors

Technical data

Magnet system characteristics

Contactor types		AC operated	A40	A50	A63	A75	A95	A110	
Coil operating limits		AC supply	At $\theta \leq 55\text{ °C}$ $0.85...1.1 \times U_c$					at $\theta \leq 70\text{ °C}$ $0.85...1.1 \times U_c$	
acc. to IEC 60947-4-1			Please also refer to "Mounting characteristics and conditions for use"						
AC control voltage	Rated control circuit voltage U_c	at 50 Hz	24...690 V						
		at 60 Hz	24...690 V						
Coil consumption	Average pull-in value	50 Hz	120 VA	180 VA		350 VA			
		60 Hz	140 VA	210 VA		450 VA			
		50/60 Hz (1)	125 VA / 120 VA	190 VA / 180 VA		410 VA / 365 VA			
		Average holding value	50 Hz	12 VA / 3 W	18 VA / 5.5 W		22 VA / 6.5 W		
			60 Hz	12 VA / 3 W	18 VA / 5.5 W		26 VA / 8 W		
			50/60 Hz (1)	12 VA / 3 W	18 VA / 5.5 W		27 VA / 7.5 W		
Drop-out voltage			Approx. 40...65 % of U_c						
Operating time									
Between coil energization and:		N.O. contact closing	8...21 ms	8...27 ms		10...25 ms			
		N.C. contact opening	6...18 ms	7...22 ms		7...22 ms			
Between coil de-energization and:		N.O. contact opening	4...11 ms	4...11 ms		7...15 ms			
		N.C. contact closing	7...14 ms	7...14 ms		10...18 ms			

(1) 50/60 Hz coils: see "Voltage code table".

Mounting characteristics and conditions for use

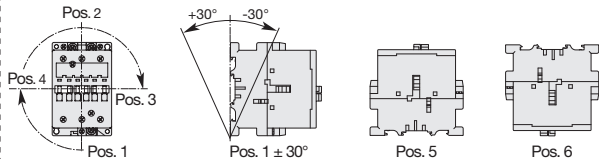
Contactor types		AC operated	A40	A50	A63	A75	A95	A110
Mounting positions								
			Max. built-in and add-on N.O. or N.C. auxiliary contacts: see accessory fitting details for 3-pole contactor A40 ... A110					
Control voltage / Ambient temperature								
Mounting positions	1, $1 \pm 30^\circ$, 2, 3, 4, 5	at $\theta \leq 55\text{ °C}$	0.85...1.1 x U_c		0.85...1.1 x U_c			
		at $\theta \leq 70\text{ °C}$	U_c		0.85...1.1 x U_c			
		at $\theta \leq 55\text{ °C}$	0.95...1.1 x U_c		Unauthorized			
		at $\theta \leq 70\text{ °C}$	Unauthorized		Unauthorized			
Mounting distances			The contactors can be assembled side by side					
Fixing	On rail according to IEC 60715, EN 60715		35 x 7.5 mm or 35 x 15 mm	35 x 15 mm or 75 x 25 mm		-		
	By screws (not supplied)		2 x M4 screws placed diagonally	2 x M6 screws placed diagonally		2 x M6 screws placed diagonally		

AL40 and AE50 ... AE75 3-pole contactors

Technical data

Magnet system characteristics

Contactor types		DC operated	AL40	AE50	AE63	AE75
Coil operating limits acc. to IEC 60947-4-1		DC supply	at $\theta \leq 55^\circ\text{C}$ 0.85...1.1 x U_c Please also refer to "Mounting characteristics and conditions for use"			
DC control voltage	Rated control circuit voltage U_c		12...250 V DC			
	Coil consumption	Average pull-in value	3.5 W	200 W		
		Average holding value	3.5 W	4 W		
Drop-out voltage			approx. 10...30 % of U_c	approx. 15...40 % of U_c		
Coil time constant	Open	L/R	38 ms	3 ms		
	Closed	L/R	62 ms	15 ms		
Operating time						
Between coil energization and:		N.O. contact closing	55...110 ms	13...30 ms		
		N.C. contact opening	25...75 ms	10...27 ms		
Between coil de-energization and:		N.O. contact opening (1)	12...18 ms	5...15 ms		
		N.C. contact closing (1)	18...28 ms	8...18 ms		

(1) The use of surge suppressors increases the opening time with a factor of 1.1 to 1.5 for a RV5 surge suppressor and a factor of 1.5 to 3 for a RT5 surge suppressor.

Mounting characteristics and conditions for use

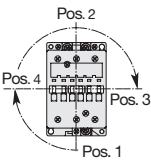
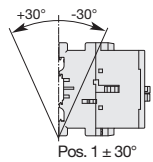
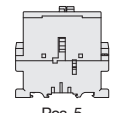
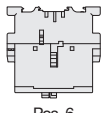
Contactor types		DC operated	AL40	AE50	AE63	AE75
Mounting positions						
Control voltage / Ambient temperature			Max. built-in and add-on N.O. or N.C. auxiliary contacts: see accessory fitting details for 3-pole contactor AL40, AE50 ... AE75			
Mounting positions	1, 1±30°, 2, 3, 4, 5	at $\theta \leq 55^\circ\text{C}$	0.85 x U_c ...1.1 x U_c			
		at $\theta \leq 70^\circ\text{C}$	Uc			
	6	at $\theta \leq 55^\circ\text{C}$	Unauthorized	0.95 x U_c ...1.1 x U_c		
		at $\theta \leq 70^\circ\text{C}$	Unauthorized			
Mounting distances			The contactors can be assembled side by side			
Fixing	On rail according to IEC 60715, EN 60715		35 x 7.5 mm or 35 x 15 mm	35 x 15 mm or 75 x 25 mm		
	By screws (not supplied)		2 x M4 screws placed diagonally	2 x M6 screws placed diagonally		

AF50 ... AF110 3-pole contactors

Technical data

Magnet system characteristics

Contactor types		AC / DC operated	AF50	AF63	AF75	AF95	AF110
Coil operating limits		AC or DC supply	At $\theta \leq 70\text{ °C}$ $0.85 \times U_c \text{ min...} 1.1 \times U_c \text{ max.}$ Please also refer to "Mounting characteristics and conditions for use"				
acc. to IEC 60947-4-1							
AC control voltage 50/60 Hz	Rated control circuit voltage U_c		48...250 V 50/60 Hz				
	Coil consumption	Average pull-in value	210 VA				
		Average holding value	7 VA / 2.8 W				
DC control voltage	Rated control circuit voltage U_c		20...250 V DC				
	Coil consumption	Average pull-in value	190 W				
		Average holding value	2.8 W				
Drop-out voltage			55 % of $U_c \text{ min.}$				
Voltage sag immunity			Conditions of use on request				
acc. to SEMI F47							
Dips withstand			$\geq 20 \text{ ms}$				
Operating time							
Between coil energization and:	N.O. contact closing		30...100 ms			30...80 ms	
	N.C. contact opening		27...95 ms			27...77 ms	
Between coil de-energization and:	N.O. contact opening		30...110 ms			55...125 ms	
	N.C. contact closing		35...115 ms			60...130 ms	

5

Mounting characteristics and conditions for use

Contactor types		AC / DC operated	AF50	AF63	AF75	AF95	AF110
Mounting positions							
			Max. built-in and add-on N.O. or N.C. auxiliary contacts: see accessory fitting details for 3-pole contactor AF50 ... AF110				
Control voltage / Ambient temperature							
Mounting positions	1, $1 \pm 30^\circ$, 2, 3, 4, 5	at $\theta \leq 70\text{ °C}$	$0.85 \times U_c \text{ min...} 1.1 \times U_c \text{ max.}$				
	6		Unauthorized				
Mounting distances			The contactors can be assembled side by side				
Fixing	On rail according to IEC 60715, EN 60715		35 x 15 mm or 75 x 25 mm				
	By screws (not supplied)		2 x M6 screws placed diagonally				

A145 ... A300 3-pole contactors

Technical data

Magnet system characteristics

Contactor types		AC operated	A145	A185	A210	A260	A300
Coil operating limits acc. to IEC 60947-4-1		AC supply	At $\theta \leq 70^\circ\text{C}$ 0.85...1.1 x U_c				
AC control voltage		Rated control circuit voltage U_c	Please also refer to "Mounting characteristics and conditions for use"				
		at 50 Hz	24...690 V				
		at 60 Hz	24...690 V				
Coil consumption	Average pull-in value	50 Hz	550 VA		1350 VA		
		60 Hz	600 VA		1550 VA		
	50/60 Hz (1)	700 VA / 650 VA		1700 VA / 1550 VA			
	Average holding value	50 Hz	35 VA / 11 W		60 VA / 16 W		
		60 Hz	40 VA / 12 W		65 VA / 19 W		
		50/60 Hz (1)	44 VA / 13 W		80 VA / 21 W		
Drop-out voltage			Approx. 40...65 % of U_c min.				
Operating time							
Between coil energization and:	N.O. contact closing		13...27 ms		17...35 ms		
	N.C. contact opening		8...22 ms		12...30 ms		
Between coil de-energization and:	N.O. contact opening		5...10 ms		7...13 ms		
	N.C. contact closing		9...13 ms		10...16 ms		

(1) 50/60 Hz coils: see "Voltage code table".

Mounting characteristics and conditions for use

Contactor types		AC operated	A145	A185	A210	A260	A300
Mounting positions							
			Max. add-on N.O. or N.C. auxiliary contacts: see accessory fitting details for 3-pole contactor A145 ... A300				
Control voltage / Ambient temperature							
Mounting positions	1, 1±30°, 2, 3, 4, 5	at $\theta \leq 70^\circ\text{C}$	0.85 x U_c ...1.1 x U_c				
	6		Unauthorized				
Mounting distances			The contactors can be assembled side by side				
Fixing	On rail according to IEC 60715, EN 60715		-				
	By screws (not supplied)		4 x M5				

AF145 ... AF300 3-pole contactors

Technical data

Magnet system characteristics

Contactor types		AC / DC operated	AF145	AF185	AF210	AF260	AF300
Coil operating limits acc. to IEC 60947-4-1		AC or DC supply	At $\theta \leq 70^\circ\text{C}$ $0.85 \times U_c \text{ min} \dots 1.1 \times U_c \text{ max}$. Please also refer to "Mounting characteristics and conditions for use"				
AC control voltage 50/60 Hz	Rated control circuit voltage U_c		48...250 V AC				
	Coil consumption	Average pull-in value	430 VA			470 VA	
		Average holding value	12 VA / 3.5 W			10 VA / 2.5 W	
DC control voltage	Rated control circuit voltage U_c		20...250 V DC				
	Coil consumption	Average pull-in value	500 W			520 W	
		Average holding value	2 W			2 W	
Drop-out voltage			55 % of $U_c \text{ min}$.				
Voltage sag immunity acc. to SEMI F47			Conditions of use on request				
Dips withstand			$\geq 20 \text{ ms}$				
Operating time							
Between coil energization and:	N.O. contact closing		30...115 ms				
	N.C. contact opening		30...115 ms				
Between coil de-energization and:	N.O. contact opening		25...80 ms				
	N.C. contact closing		25...80 ms				

5

Mounting characteristics and conditions for use

Contactor types		AC / DC operated	AF145	AF185	AF210	AF260	AF300
Mounting positions							
			Max. add-on N.O. or N.C. auxiliary contacts: see accessory fitting details for 3-pole contactor AF145 ... AF2050				
Control voltage / Ambient temperature							
Mounting positions	1, $1 \pm 30^\circ$, 2, 3, 4, 5	at $\theta \leq 70^\circ\text{C}$	$0.85 \times U_c \text{ min} \dots 1.1 \times U_c \text{ max}$.				
	6		Unauthorized				
Mounting distances			The contactors can be assembled side by side				
Fixing	On rail according to IEC 60715, EN 60715		-				
	By screws (not supplied)		4 x M5				

AF400 ... AF2050 3-pole contactors

Technical data

Magnet system characteristics

Contactor types		AC / DC operated	AF400	AF460	AF580	AF750	AF1250	AF1350	AF1650	AF2050
Coil operating limits		AC or DC supply	At $\theta \leq 70^\circ\text{C}$ $0.85 \times U_c \text{ min...} 1.1 \times U_c \text{ max.}$							
acc. to IEC 60947-4-1			Please also refer to "Mounting characteristics and conditions for use"							
AC control voltage 50/60 Hz	Rated control circuit voltage U_c		48...500 V AC				100...250 V			
	Coil consumption	Average pull-in value	890 VA		850 VA		1900 VA			
		Average holding value	12 VA / 4 W		12 VA / 4.5 W		48 VA / 17 W			
DC control voltage	Rated control circuit voltage U_c		24...500 V DC				100...250 V			
	Coil consumption	Average pull-in value	990 W		950 W		1700 W			
		Average holding value	4 W		4.5 W		16 W			
Drop-out voltage			55 % of $U_c \text{ min.}$							
Voltage sag immunity			Conditions of use on request							
acc. to SEMI F47										
Dips withstand			$\geq 20 \text{ ms}$							
Operating time										
Coil supply between A1 - A2										
Between coil energization and:	N.O. contact closing		50...120 ms				50...80 ms			
	N.C. contact opening		50...120 ms				50...80 ms			
Between coil de-energization and:	N.O. contact opening		33...70 ms				35...55 ms			
	N.C. contact closing		33...70 ms				35...55 ms			
Control input for PLC's										
Between coil energization and:	N.O. contact closing		40...60 ms		40...90 ms		40...65 ms			
	N.C. contact opening		40...60 ms		40...90 ms		40...65 ms			
Between coil de-energization and:	N.O. contact opening		10...30 ms				10...30 ms			
	N.C. contact closing		10...30 ms				10...30 ms			















Mounting characteristics and conditions for use

Contactor types		AC / DC operated	AF400	AF460	AF580	AF750	AF1250	AF1350	AF1650	AF2050
Mounting positions										
			Max. add-on N.O. or N.C. auxiliary contacts: see accessory fitting details for 3-pole contactor AF400 ... AF2050							
Control voltage / Ambient temperature										
Mounting positions	1, $1 \pm 30^\circ$, 2, 3, 4, 5	at $\theta \leq 70^\circ\text{C}$	$0.85 \times U_c \text{ min...} 1.1 \times U_c \text{ max.}$							
	6		Unauthorized							
Mounting distances			The contactors can be assembled side by side							
Fixing	On rail according to IEC 60715, EN 60715		-							
	By screws (not supplied)		4 x M5		4 x M6		4 x M8			

AF09 ... AF38 3-pole contactors

Technical data









Connecting characteristics

Contactor types	AC / DC operated	AF09	AF12	AF16	AF26	AF30	AF38
Main terminals		 Screw terminals with cable clamp					
Connection capacity (min. ... max.)							
Main conductors (poles)							
 Rigid	Solid ($\leq 4 \text{ mm}^2$) Stranded ($\geq 6 \text{ mm}^2$)	1 x	1...6 mm ²			2.5...10 mm ²	
 Stranded		2 x	1...6 mm ²			2.5...10 mm ²	
 Flexible with non insulated ferrule		1 x	0.75...6 mm ²			1.5...10 mm ²	
 Flexible with insulated ferrule		2 x	0.75...6 mm ²			1.5...10 mm ²	
 Flexible with insulated ferrule		1 x	0.75...4 mm ²			1.5...10 mm ²	
 Flexible with insulated ferrule		2 x	0.75...2.5 mm ²			1.5...4 mm ²	
 Bars or lugs		L <	9.6 mm			12.5 mm	
Connection capacity acc. to UL/CSA		1 or 2 x	AWG 16...10			AWG 14...8	
Stripping length			10 mm			14 mm	
Tightening torque			1.5 Nm / 13 lb.in			2.5 Nm / 22 lb.in	
Auxiliary conductors							
(built-in auxiliary terminals + coil terminals)							
 Rigid solid		1 x	1...2.5 mm ²				
 Rigid solid		2 x	1...2.5 mm ²				
 Flexible with non insulated ferrule		1 x	0.75...2.5 mm ²				
 Flexible with non insulated ferrule		2 x	0.75...2.5 mm ²				
 Flexible with insulated ferrule		1 x	0.75...2.5 mm ²				
 Flexible with insulated ferrule		2 x	0.75...1.5 mm ²				
 Lugs		L <	8 mm				
Connection capacity acc. to UL/CSA		1 or 2 x	AWG 18...14				
Stripping length			10 mm				
Tightening torque							
Coil terminals			1.2 Nm / 11 lb.in				
Built-in auxiliary terminals			1.2 Nm / 11 lb.in				
Degree of protection							
acc. to IEC 60947-1 / EN 60947-1 and IEC 60529 / EN 60529							
Main terminals			IP20				
Coil terminals			IP20				
Built-in auxiliary terminals			IP20				
Screw terminals							
Delivered in open position, screws of unused terminals must be tightened							
Main terminals			M3.5			M4	
		Screwdriver type	Flat Ø 5.5 / Pozidriv 2			Flat Ø 6.5 / Pozidriv 2	
Coil terminals			M3.5				
		Screwdriver type	Flat Ø 5.5 / Pozidriv 2				
Built-in auxiliary terminals			M3.5				
		Screwdriver type	Flat Ø 5.5 / Pozidriv 2				

A40 ... A110, AL, AE, TAL, TAE and AF50 ... AF110 3-pole contactors

Technical data

Connecting characteristics

Contactor types		AC operated	A40	A50	A63	A75	A95	A110	
DC operated			AL40	AE50	AE63	AE75	–	–	
AC / DC operated			TAL40	TAE50	–	TAE75	–	–	
Main terminals									
			Screw terminals with double connector 2 x (5.6 x 6.5 mm)	Screw terminals with single connector (13 x 10 mm)			Screw terminals with single connector (14 x 14 mm)		
Connection capacity (min. ... max.)									
Main conductors (poles)									
	Rigid	Solid ($\leq 4 \text{ mm}^2$)	1 x 2.5...16 mm ²	6...50 mm ²			10...95 mm ²		
		Stranded ($\geq 6 \text{ mm}^2$)	2 x 2.5...16 mm ²	6...25 mm ²			6...35 mm ²		
	Flexible with ferrule		1 x 2.5...10 mm ²	6...35 mm ²			10...70 mm ² (1)		
			2 x 2.5...10 mm ²	6...16 mm ²			6...35 mm ² (1)		
	Bars or lugs	$L \leq$	–	–			30 mm (2)		
		$l >$	–	–			6 mm		
Connection capacity acc. to UL/CSA			1 or 2 x AWG 8...4	AWG 8...1			AWG 6...2/0		
Tightening torque		Recommended	2.30 Nm / 20 lb.in	4.00 Nm / 35 lb.in			8 Nm / 71 lb.in		
		Max.	2.60 Nm	4.50 Nm			9 Nm		
Auxiliary conductors									
(built-in auxiliary terminals + coil terminals)									
	Rigid solid		1 x 1...4 mm ²				0.75...2.5 mm ²		
			2 x 1...4 mm ²				0.75...2.5 mm ²		
	Flexible with ferrule		1 x 0.75...2.5 mm ²	1...2.5 mm ²			0.75...2.5 mm ²		
			2 x 0.75...2.5 mm ²				0.75...2.5 mm ²		
	Lugs	$L \leq$	8 mm						
		$l >$	3.7 mm						
Connection capacity acc. to UL/CSA			1 or 2 x AWG 18...14						
Tightening torque									
Coil terminals		Recommended	1.00 Nm / 9 lb.in						
		Max.	1.20 Nm						
Built-in auxiliary terminals		Recommended	1.00 Nm / 9 lb.in	–			–		
		Max.	1.20 Nm	–			–		
Degree of protection									
acc. to IEC 60947-1 / EN 60947-1 and IEC 60529 / EN 60529									
Main terminals			IP20	IP10					
Coil terminals			IP20						
Built-in auxiliary terminals			IP20	–			–		
Screw terminals									
Main terminals			Delivered in open position, screws of unused terminals must be tightened						
			M5	M6			M8		
		Screwdriver type	Flat Ø 6.5 / Pozidriv 2				Hexagon socket (s = 4 mm)		
Coil terminals			M3.5						
		Screwdriver type	Flat Ø 5.5 / Pozidriv 2						
Built-in auxiliary terminals			M3.5						
		Screwdriver type	Flat Ø 5.5 / Pozidriv 2						

(1) A(F)95 / A(F)110: use flexible without ferrule.

(2) With LW110 enlargement piece, see "Accessories".

A145 ... A300 and AF145 ... AF300 3-pole contactors

Technical data

Connecting characteristics











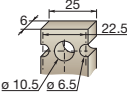
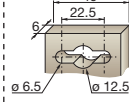
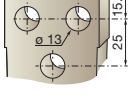
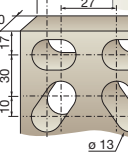
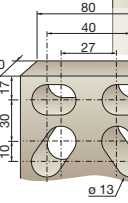

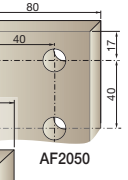
Contactor types	AC operated		A145	A185	A210	A260	A300	
	AC / DC operated		AF145	AF185	AF210	AF260	AF300	
Main terminals Flat type								
Connection capacity (min. ... max.)								
Main conductors (poles)								
 Rigid with connector	Single for Cu cable		6...185 mm ²		16...240 mm ²			
 Rigid with connector	Single for Al/Cu cable		25...150 mm ²		120...240 mm ²			
 Rigid with connector	Double for Al/Cu cable		-		2 x 95...120 mm ²			
 Bars or lugs			L ≤ 24 mm		32 mm			
			Ø > 8 mm		10 mm			
Connection capacity acc. to UL/CSA		1 or 2 x	6 - 250 MCM		4 - 500 MCM (1)			
Tightening torque	Recommended		18 Nm / 160 lb.in		28 Nm / 247 lb.in			
	Max.		20 Nm		30 Nm			
Auxiliary conductors (coil terminals)								
 Rigid solid		1 x	1...4 mm ²					
		2 x	1...4 mm ²					
 Flexible with ferrule		1 x	0.75...2.5 mm ²					
		2 x	0.75...2.5 mm ²					
 Lugs			L ≤ 8 mm					
			l > 3.7 mm					
Connection capacity acc. to UL/CSA		1 or 2 x	AWG 18...14					
Tightening torque	Recommended		1.00 Nm / 9 lb.in					
	Max.		1.20 Nm					
Degree of protection acc. to IEC 60947-1 / EN 60947-1 and IEC 60529 / EN 60529								
Main terminals			IP00					
Coil terminals			IP20					
Screw terminals								
Main terminals			M8		M10			
			Screws and bolts					
Coil terminals (delivered in open position)			M3.5					
			Screwdriver type		Flat Ø 5.5 mm / Pozidriv 2			

(1) With LW110 enlargement piece: see "Accessories".

AF400 ... AF2050 3-pole contactors

Technical data

Connecting characteristics

Contactor types	AC / DC operated	AF400	AF460	AF580	AF750	AF1250	AF1350	AF1650	AF2050
Main terminals									
Flat type									
Connection capacity (min. ... max.)									
Main conductors (poles)									
	Rigid with connector	Single for Cu cable	240 mm ²	300 mm ²	—	—	—	—	—
	Rigid with connector	Single for Al/Cu cable	240 mm ²	300 mm ²	—	—	—	—	—
	Rigid with connector	Double for Al/Cu cable	2 x 240 mm ²	3 x 185 mm ²	—	—	—	—	—
	Bars or lugs	L ≤	47 mm	52 mm	100 mm	—	—	—	—
		Ø >	10 mm	12 mm	12 mm	—	—	—	—
	Connection capacity acc. to UL/CSA	1 or 2 x	2//250 - 500 MCM	3// 2/0 - 500 MCM	1/0 - 750 MCM	—	—	—	—
	Tightening torque	Recommended	35 Nm / 310 lb.in	45 Nm / 398 lb.in	45 Nm / 398 lb.in	—	—	—	—
		Max.	40 Nm	49 Nm	49 Nm	—	—	—	—
Auxiliary conductors (coil terminals)									
	Rigid solid	1 x	1...4 mm ²	—	—	—	—	—	—
	Rigid solid	2 x	1...4 mm ²	—	—	—	—	—	—
	Flexible with ferrule	1 x	0.75...2.5 mm ²	—	—	—	—	—	—
	Flexible with ferrule	2 x	0.75...2.5 mm ²	—	—	—	—	—	—
	Lugs	L ≤	8 mm	—	—	—	—	—	—
		L >	3.7 mm	—	—	—	—	—	—
	Connection capacity acc. to UL/CSA	1 or 2 x	AWG 18...14	—	—	—	—	—	—
	Tightening torque	Recommended	1.00 Nm / 9 lb.in	—	—	—	—	—	—
		Max.	1.20 Nm	—	—	—	—	—	—
Degree of protection									
acc. to IEC 60947-1 / EN 60947-1 and IEC 60529 / EN 60529									
	Main terminals		IP00	—	—	—	—	—	—
	Coil terminals		IP20	—	—	—	—	—	—
Screw terminals									
	Main terminals		M10	M12	—	—	—	—	—
			Screws and bolts	—	—	—	—	—	—
	Coil terminals (delivered in open position)		M3,5	—	—	—	—	—	—
		Screwdriver type	Flat Ø 5.5 mm / Pozidriv 2	—	—	—	—	—	—

5

AF09 ... AF38 3-pole contactors

Technical data

Built-in auxiliary contacts according to IEC

Contactor types	AC / DC operated	AF09	AF12	AF16	AF26	AF30	AF38
Rated operational voltage U_e max.		690 V					
Rated frequency (without derating)		50 / 60 Hz					
Conventional free air thermal current $I_{th} - \theta \leq 40^\circ\text{C}$		16 A					
le / Rated operational current AC-15		6 A					
acc. to IEC 60947-5-1	24-127 V 50/60 Hz	6 A					
	220-240 V 50/60 Hz	4 A					
	400-440 V 50/60 Hz	3 A					
	500 V 50/60 Hz	2 A					
	690 V 50/60 Hz	2 A					
Making capacity AC-15		10 x le AC-15 acc. to IEC 60947-5-1					
Breaking capacity AC-15		10 x le AC-15 acc. to IEC 60947-5-1					
le / Rated operational current DC-13		6 A / 144 W					
acc. to IEC 60947-5-1	24 V DC	6 A / 144 W					
	48 V DC	2.8 A / 134 W					
	72 V DC	1 A / 72 W					
	110 V DC	0.55 A / 60 W					
	125 V DC	0.55 A / 69 W					
	220 V DC	0.27 A / 60 W					
	250 V DC	0.27 A / 68 W					
	400 V DC	0.15 A / 60 W					
	500 V DC	0.13 A / 65 W					
	600 V DC	0.1 A / 60 W					
Short-circuit protection device gG type fuse		10 A					
Rated short-time withstand current I_{cw}	for 1.0 s	100 A					
	for 0.1 s	140 A					
Minimum switching capacity		12 V / 3 mA					
with failure rate acc. to IEC 60947-5-4		10^{-7}					
Non-overlapping time between N.O. and N.C. contacts		≥ 2 ms					
Power dissipation per pole at 6 A		0.1 W					
Max. electrical switching frequency	AC-15	1200 cycles/h					
	DC-13	900 cycles/h					
Mechanically linked contacts		Built-in N.O. or N.C. auxiliary contacts and additional N.O. or N.C. auxiliary contacts (CA4, CAL4, CAT4 aux. contact blocks) are mechanically linked contacts.					
Mirror contacts		Built-in N.C. auxiliary contacts or additional N.C. auxiliary contacts (CA4, CAL4, CAT4 aux. contact blocks) are mirror contacts.					
acc. to annex F of IEC 60947-4-1							

5

Built-in auxiliary contacts according to UL / CSA

Contactor types	AC / DC operated	AF09	AF12	AF16	AF26	AF30	AF38
Max. operational voltage		600 V AC, 600 V DC					
Pilot duty		A600, Q600					
AC thermal rated current		10 A					
AC maximum volt-ampere making		7200 VA					
AC maximum volt-ampere breaking		720 VA					
DC thermal rated current		2.5 A					
DC maximum volt-ampere making-breaking		69 VA					

A40, AL40 and TAL40 3-pole contactors

Technical data

Built-in auxiliary contacts according to IEC

Contactor types	AC operated	A40
	DC operated	AL40, TAL40
Rated operational voltage U _e max.		690 V
Rated frequency (without derating)		50/60 Hz
Conventional free air thermal current I _{th} - θ ≤ 40 °C		16 A
I _e / Rated operational current AC-15		
acc. to IEC 60947-5-1	24-127 V 50/60 Hz	6 A
	220-240 V 50/60 Hz	4 A
	380-440 V 50/60 Hz	3 A
	500 V 50/60 Hz	2 A
	690 V 50/60 Hz	2 A
Making capacity AC-15		10 x I _e AC-15 acc. to IEC 60947-5-1
Breaking capacity AC-15		10 x I _e AC-15 acc. to IEC 60947-5-1
I _e / Rated operational current DC-13		
acc. to IEC 60947-5-1	24 V DC	6 A / 144 W
	48 V DC	2.8 A / 134 W
	72 V DC	2 A / 144 W
	110 V DC	1.1 A / 121 W
	125 V DC	1.1 A / 138 W
	220 V DC	0.55 A / 121 W
	250 V DC	0.55 A / 138 W
Short-circuit protection device gG type fuse		10 A
Rated short-time withstand current I _{cw}	for 1.0 s	100 A
	for 0.1 s	140 A
Minimum switching capacity		17 V / 5 mA
with failure rate acc. to IEC 60947-5-4		≤ 10 ⁻⁷ for AL40 and TAL40 contactors
Non-overlapping time between N.O. and N.C. contacts		≥ 2 ms
Power dissipation per pole at 6 A		0.1 W
Max. electrical switching frequency	AC-15	1200 cycles/h
	DC-13	900 cycles/h
Mechanically linked contacts		Built-in N.O. or N.C. auxiliary contacts and additional N.O. or N.C. auxiliary contacts of 4-pole CA5 are mechanically linked contacts.
acc. to annex L of IEC 60947-5-1		
Mirror contacts		Built-in N.C. auxiliary contacts or additional N.C. auxiliary contacts (CA5, CAL5-11) are mirror contacts.
acc. to annex F of IEC 60947-4-1		

Built-in auxiliary contacts according to UL / CSA

Contactor types	AC operated	A40
	DC operated	AL40, TAL40
Max. operational voltage		600 V AC, 600 V DC
Pilot duty		A600, P300
AC thermal rated current		10 A
AC maximum volt-ampere making		7200 VA
AC maximum volt-ampere breaking		720 VA
DC thermal rated current		5 A
DC maximum volt-ampere making-breaking		138 VA

3-pole contactors

Electrical durability and utilization categories

General

Utilization categories determine the current making and breaking conditions relating to the characteristics of the loads to be controlled by the contactors. International standard IEC 60947-4-1 and European standard EN 60947-4-1 are the standards to be referred to.

If I_c is the current to be broken by the contactor and I_e the rated operational current normally drawn by the load, then:

- Categories AC-1 and AC-3: $I_c = I_e$
- Category AC-2: $I_c = 2.5 \times I_e$
- Category AC-4: $I_c = 6 \times I_e$

Generally speaking $I_c = m \times I_e$ where m is a multiple of the load operational current.

On next pages, the curves corresponding to categories AC-1, AC-3 and AC-4 represent the electrical durability variation of standard contactors in relation to the breaking current I_c .

Electrical durability is expressed in millions of operating cycles.

Curve utilization mode

Electrical durability forecast and contactor selection for categories AC-1, AC-2, AC-3 or AC-4

- Note the characteristics of the load to be controlled:
 - Operational voltage U_e
 - Current normally drawn I_e ($U_e / I_e / kW$ relation for motors, see "Motor rated operational powers and currents").
 - Utilization category AC-1, AC-2, AC-3 or AC-4
 - Breaking current $I_c = I_e$ for AC-1 and for AC-3 ; $I_c = 2.5 \times I_e$ for AC-2 ; $I_c = 6 \times I_e$ for AC-4
- Define the number of operating cycles N required.
- On the diagram corresponding to the operational category, select the contactor with the curve immediately above the intersection point ($I_c ; N$).

Electrical durability forecast and contactor selection for mixed duty motor control: AC-3 ($I_c = I_e$) type switching off while "motor running" and, occasionally, AC-4 ($I_c = 6 \times I_e$) type switching off while "motor accelerating"

- Note the characteristics of the motor to be controlled:
 - Operational voltage U_e
 - Current normally drawn while "motor running" I_e ($U_e / I_e / kW$ relation for motors, see "Motor rated operational powers and currents")
 - Breaking current for AC-3 $I_c = I_e$
 - Breaking current for AC-4 while "motor accelerating" $I_c = 6 \times I_e$
 - Percentage of AC-4 operating cycles K (on the basis of the total number of operating cycles)
- Define the total number of operating cycles N required.
- Note the smallest contactor rating compatible for AC-3 (U_e / I_e) on Main pole utilization characteristic table (see "Technical data").
- For the selected contactor make a note of the following in relation to the voltage using diagram AC-3 in next pages:
 - The number of operating cycles A for $I_c = I_e$ (AC-3)
 - The number of operating cycles B for $I_c = 6 \times I_e$ (AC-4)
- Calculate the estimated number of cycles N' (N' is always below A)

$$N' = \frac{A}{1 + 0.01 K (A/B - 1)}$$

- If N' is too low in relation to the target N , calculate the estimated number of cycles for a higher contactor rating.

Case of uninterrupted duty

For uninterrupted duty, some verifications of preventing maintenance are necessary to check the functionality of the concerned product (consult us).

The combined effect of environmental conditions and the proper temperature of the product may require some disposals. As a matter of fact, for this duty, the use duration prevails over the number of operating cycles.

3-pole contactors

Electrical durability

Electrical durability for AC-1 utilization category - $U_e \leq 690 \text{ V}$

Ambient temperature $\leq 60 \text{ }^\circ\text{C}$ for AF09 ... AF38, $\leq 55 \text{ }^\circ\text{C}$ for A40 ... AF2050

Switching non-inductive or slightly inductive loads. The breaking current I_c for AC-1 is equal to the rated operational current of the load.

Maximum electrical switching frequency: see "Technical data".

**AF1250, AF1350,
AF1650, AF2050:**
The electrical durability at
the rated current is 50000
operating cycles.

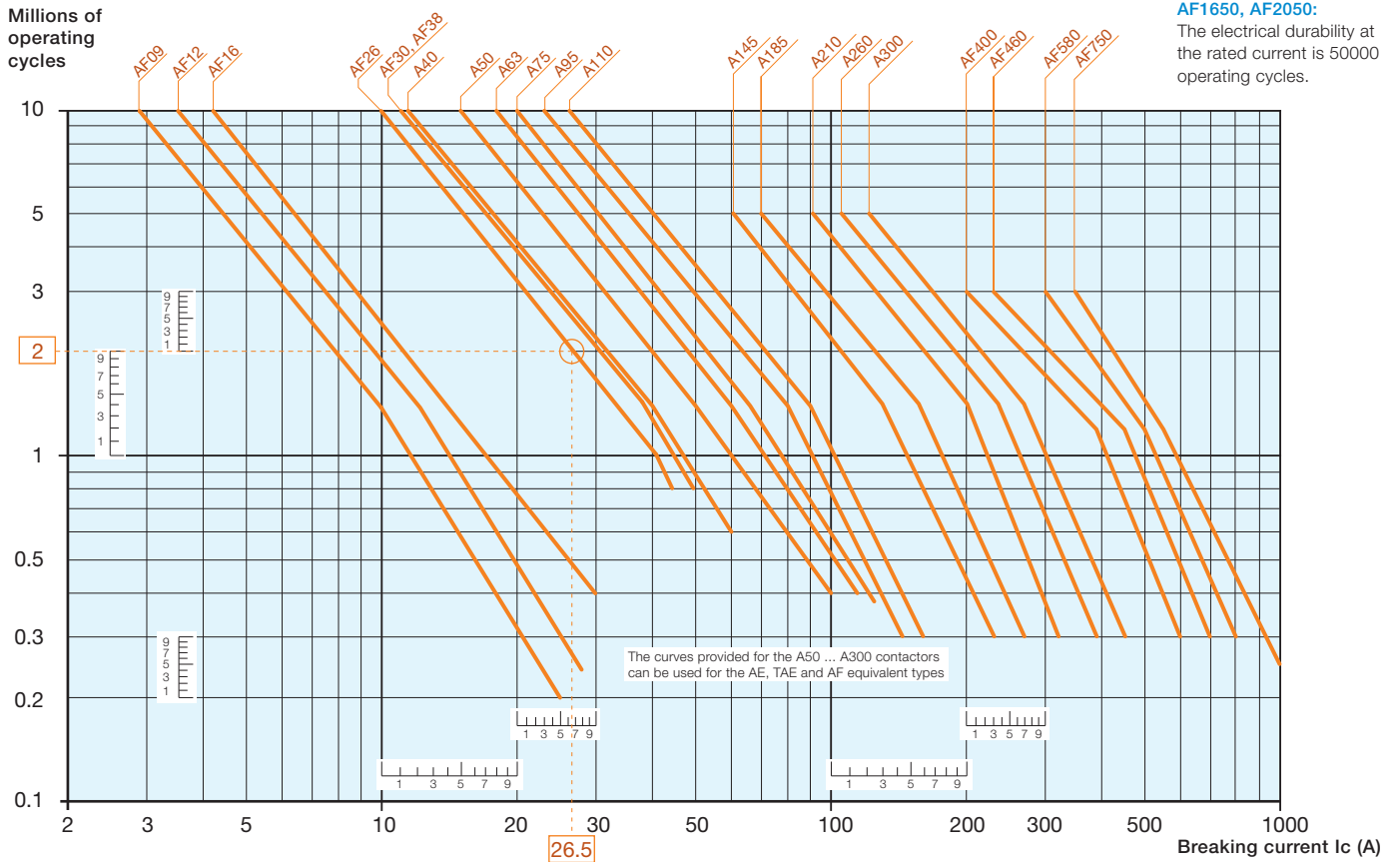

Example:

$I_c / \text{AC-1} = 26.5 \text{ A}$ – Electrical durability required = 2 millions operating cycles.

Using the AC-1 curves above select the AF26 contactor at intersection "○" (26.5 A / 2 millions operating cycles).

3-pole contactors

Electrical durability

Electrical durability for AC-3 utilization category - $U_e \leq 440 \text{ V}$

Ambient temperature $\leq 60 \text{ }^\circ\text{C}$ for AF09 ... AF38, $\leq 55 \text{ }^\circ\text{C}$ for A40 ... AF1650

Switching cage motors: starting and switching off running motors. The breaking current I_c for AC-3 is equal to the rated operational current I_e ($I_e = \text{motor full load current}$). Maximum electrical switching frequency: see "Technical data".

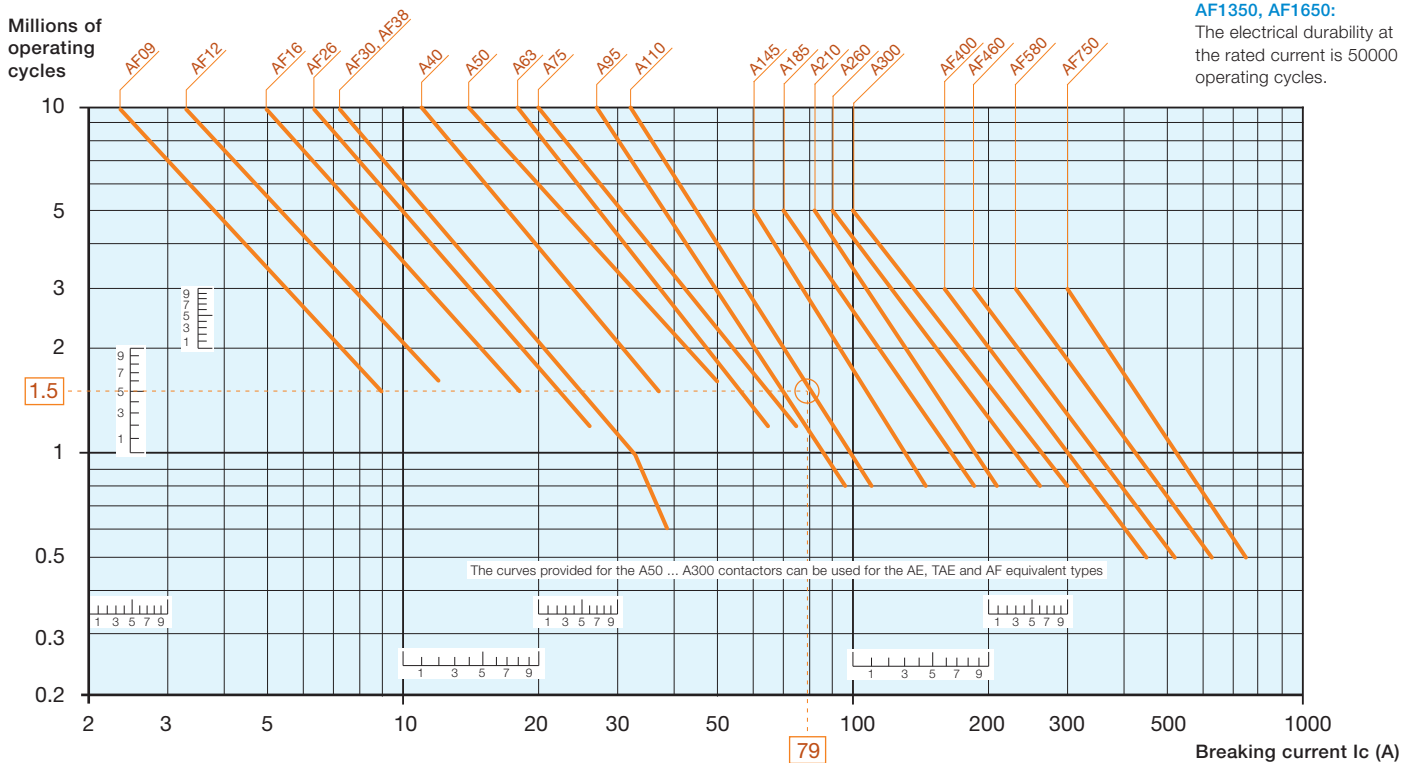

Example:

Motor power 40 kW for AC-3 - $U_e = 400 \text{ V}$ and $I_e = 79 \text{ A}$ utilization – Electrical durability required = 1.5 million operating cycles. For AC-3: $I_c = I_e$. Select the A110 contactor at intersection "O" (79 A / 1.5 million operating cycles) on the curves (AC-3 - $U_e \leq 440 \text{ V}$).

3-pole contactors

Electrical durability

Electrical durability for AC-2 or AC-4 utilization category - $U_e < 440\text{ V}$

Ambient temperature $\leq 60\text{ }^\circ\text{C}$ for AF09 ... AF38, $\leq 55\text{ }^\circ\text{C}$ for A40 ... AF1650

Switching cage motors: starting, reverse operation and step-by-step operation. The breaking current I_c is equal to $2.5 \times I_e$ for AC-2 and $6 \times I_e$ for AC-4, keeping in mind that I_e is the motor rated operational current (I_e = motor full-load current).

Maximum electrical switching frequency: see "Technical data".

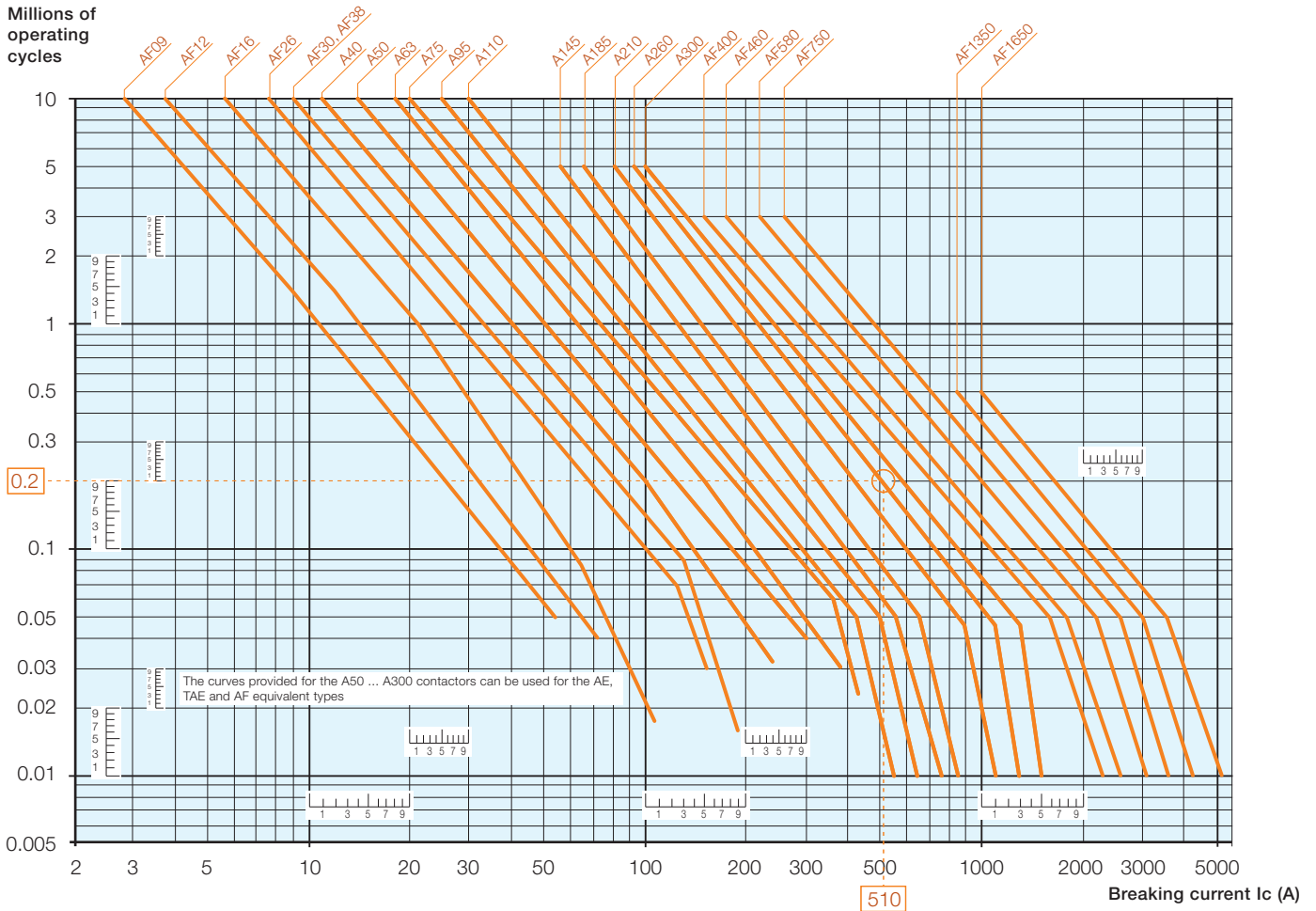

Example:

Motor power 45 kW for AC-4 - $U_e = 400\text{ V}$ and $I_e = 85\text{ A}$ utilization – Electrical durability required = 0.2 million operating cycles. For AC-4: $I_c = 6 \times I_e = 510\text{ A}$ - Select the A260 contactor at intersection "O" (510 A / 0.2 million operating cycles) on the curves (AC-4 - $U_e \leq 440\text{ V}$).

Notes

A series of horizontal dotted lines for writing notes.



AF, A and EK 4-pole contactors

[Overview](#) 5/56

Ordering details

25 to 55 A AC-1

AF09 ... AF38	AC / DC operated	5/58
AF09Z ... AF38Z	AC / DC operated - low consumption	5/59
Main accessories		5/60

70 to 125 A AC-1

A45 ... A75	AC operated	5/63
AE45 ... AE75	DC operated	5/64
AF45 ... AF75	AC / DC operated	5/65
Main accessories		5/66

200 to 1000 A AC-1

EK110 ... EK150	AC operated	5/68
EK110 ... EK150	DC operated	5/69
EK175 ... EK550	AC operated	5/70
EK175 ... EK550	DC operated	5/71
EK1000	AC operated	5/72
EK1000	DC operated	5/73
Main accessories		5/74

Technical data

Main pole - Utilization characteristics according to IEC	5/76
Main pole - Utilization characteristics according to UL / CSA	5/76
Magnet system and mounting characteristics	5/79
General technical data	5/84
Connecting characteristics	5/87
Electrical durability	5/90



Accessories

Accessories for AF09 ... AF38 contactors and NF contactor relays	5/115
Accessories for A40 ... AF2050 contactors	5/121
Accessories for EK100 ... EK1000 contactors	5/147

[Voltage code table](#) 5/157

4-pole contactors



IEC	AC-1 Rated operational current	$\theta \leq 40\text{ }^\circ\text{C}$, 690 V	A
UL/CSA	General use rating	600 V	A
AC Control supply		Type	
DC Control supply		Type	
AC / DC Control supply		Type	
IEC	AC-1 Rated operational current	$\theta \leq 40\text{ }^\circ\text{C}$	A
		$\theta \leq 55\text{ }^\circ\text{C}$ (1)	A
		$\theta \leq 70\text{ }^\circ\text{C}$	A
	With conductor cross sectional area		mm ²
	Rated operational voltage U _e max.		V
UL/CSA	General use rating	600 V	A

25	30	45	55	70	100	125
25	30	45	55	80	80	105
AF09	AF16	AF26	AF38	A45	A50	A75
AF09	AF16	AF26	AF38	AE45	AE50	AE75
AF09	AF16	AF26	AF38	AF45	AF50	AF75
25	30	45	55	70	100	125
25	30	40	45	60	85	105
22	26	32	37	50	70	85
4	6	10	16	25	35	50
690	690	690	690	690	690	690
25	30	45	55	65	80	105

(1) $\theta \leq 60\text{ }^\circ\text{C}$ for AF09 ... AF38 contactors

Main accessories

Auxiliary contact blocks	Front mounting
	Side mounting
Timers	Pneumatic (Front mounting)
	Mechanical
Interlocking units (compact reversing contactors)	Mechanical / Electrical
	Mechanical
Surge suppressors AF contactors have built-in surge protection	Varistor (AC / DC)
	RC Type (AC)
	Transil diode (DC)

CA4-10 (1 x N.O.), CA4-01 (1 x N.C.)	CA5-10 (1 x N.O.), CA5-01 (1 x N.C.)
CAL4-11 (1 x N.O. + 1 x N.C.)	CAL5-11 (1 x N.O. + 1 x N.C.)
	TP40DA, TP180DA Direct timing TP40IA, TP180IA Inverse timing
VM4	
VEM4	VE5-2
	RV5 (24...440 V)
	RC5-2 (24...440 V)
	RT5 (12...264 V)

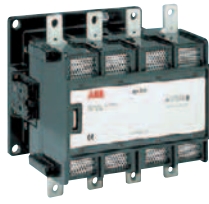

200	250	300	350	550	800	1000
170	200	250	300	420	540	—
EK110	EK150	EK175	EK210	EK370	EK550	EK1000
EK110	EK150	EK175	EK210	EK370	EK550	EK1000
—	—	—	—	—	—	—
200	250	300	350	550	800	1000
180	230	270	310	470	650	800
155	200	215	250	400	575	720
95	150	185	240	2 x 185	2 x 240	2 x 300
1000	1000	1000	1000	1000	1000	1000
170	200	250	300	420	540	—

5

CAL16-11 (1 x N.O. + 1 x N.C.)	
VH145	VH300
VH800	
RC-EH300	RC-EH800

AF09 ... AF38 4-pole contactors

25 to 55 A AC-1

AC / DC operated



AF09-40-00

1SBC101099F0014

Description

AF09 ... AF38 4-pole contactors are mainly used for controlling non-inductive or slightly inductive loads (i.e. resistance furnaces...) and generally for controlling power circuits up to 690 V AC and 440 V DC. These contactors are of the block type design with 4 main poles.

- control circuit: AC or DC operated with electronic coil interface accepting a wide control voltage range (e.g. 100...250 V AC and DC), only 4 coils to cover control voltages between 24...500 V 50/60 Hz and 20...500 V DC
 - can manage large control voltage variations
 - reduced panel energy consumption
 - very distinct closing and opening.
- built-in surge suppression
- add-on auxiliary contact blocks for front or side mounting and a wide range of accessories.

Ordering details

IEC	UL/CSA	Rated control circuit voltage		Auxiliary contacts fitted	Type	Order code	Weight
Rated operational current $\theta \leq 40^\circ\text{C}$ AC-1	General use rating 600 V AC	Uc min. ...	Uc max.				Pkg (1 pce) kg
A	A	V 50/60 Hz	V DC				

4 N.O. main poles

25	25	24...60	20...60 (1)	0	0	AF09-40-00-11	1SBL137201R1100	0.270
		48...130	48...130	0	0	AF09-40-00-12	1SBL137201R1200	0.270
		100...250	100...250	0	0	AF09-40-00-13	1SBL137201R1300	0.270
		250...500	250...500	0	0	AF09-40-00-14	1SBL137201R1400	0.310
30	30	24...60	20...60 (1)	0	0	AF16-40-00-11	1SBL177201R1100	0.270
		48...130	48...130	0	0	AF16-40-00-12	1SBL177201R1200	0.270
		100...250	100...250	0	0	AF16-40-00-13	1SBL177201R1300	0.270
		250...500	250...500	0	0	AF16-40-00-14	1SBL177201R1400	0.310
45	45	24...60	20...60 (1)	0	0	AF26-40-00-11	1SBL237201R1100	0.360
		48...130	48...130	0	0	AF26-40-00-12	1SBL237201R1200	0.360
		100...250	100...250	0	0	AF26-40-00-13	1SBL237201R1300	0.360
		250...500	250...500	0	0	AF26-40-00-14	1SBL237201R1400	0.400
55	55	24...60	20...60 (1)	0	0	AF38-40-00-11	1SBL297201R1100	0.360
		48...130	48...130	0	0	AF38-40-00-12	1SBL297201R1200	0.360
		100...250	100...250	0	0	AF38-40-00-13	1SBL297201R1300	0.360
		250...500	250...500	0	0	AF38-40-00-14	1SBL297201R1400	0.400

2 N.O. + 2 N.C. main poles

25	25	24...60	20...60 (1)	0	0	AF09-22-00-11	1SBL137501R1100	0.270
		48...130	48...130	0	0	AF09-22-00-12	1SBL137501R1200	0.270
		100...250	100...250	0	0	AF09-22-00-13	1SBL137501R1300	0.270
		250...500	250...500	0	0	AF09-22-00-14	1SBL137501R1400	0.310
30	30	24...60	20...60 (1)	0	0	AF16-22-00-11	1SBL177501R1100	0.270
		48...130	48...130	0	0	AF16-22-00-12	1SBL177501R1200	0.270
		100...250	100...250	0	0	AF16-22-00-13	1SBL177501R1300	0.270
		250...500	250...500	0	0	AF16-22-00-14	1SBL177501R1400	0.310
45	45	24...60	20...60 (1)	0	0	AF26-22-00-11	1SBL237501R1100	0.360
		48...130	48...130	0	0	AF26-22-00-12	1SBL237501R1200	0.360
		100...250	100...250	0	0	AF26-22-00-13	1SBL237501R1300	0.360
		250...500	250...500	0	0	AF26-22-00-14	1SBL237501R1400	0.400
55	55	24...60	20...60 (1)	0	0	AF38-22-00-11	1SBL297501R1100	0.360
		48...130	48...130	0	0	AF38-22-00-12	1SBL297501R1200	0.360
		100...250	100...250	0	0	AF38-22-00-13	1SBL297501R1300	0.360
		250...500	250...500	0	0	AF38-22-00-14	1SBL297501R1400	0.400

(1) AF...-...-11 not suitable for direct control by PLC-output.

Main dimensions mm, inches

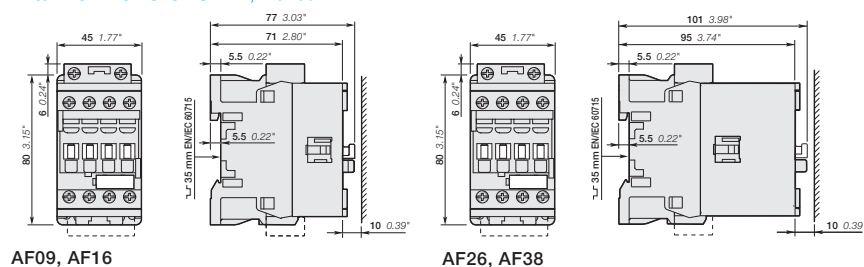

AF09, AF16

AF26, AF38

1SBC101375S0201

AF09Z ... AF38Z 4-pole contactors

25 to 55 A AC-1

AC / DC operated - low consumption



AF09Z-40-00





AF26Z-40-00

Description

AF09Z ... AF38Z 4-pole contactors are mainly used for controlling non-inductive or slightly inductive loads (i.e. resistance furnaces...) and generally for controlling power circuits up to 690 V AC and 440 V DC. These contactors are of the block type design with 4 main poles.

- control circuit: AC or DC operated with electronic coil interface accepting a wide control voltage range (e.g. 100...250 V AC and DC), only 4 coils to cover control voltages between 24...250 V 50/60 Hz and 12...250 V DC
- can manage large control voltage variations
- allow direct control by PLC-output ≥ 24 V DC 500 mA
- reduced panel energy consumption
- very distinct closing and opening
- can withstand short voltage dips and voltage sags (SEMI F47-0706 conditions of use on request).
- built-in surge suppression
- add-on auxiliary contact blocks for front or side mounting and a wide range of accessories.

Ordering details

IEC	UL/CSA	Rated control circuit voltage		Auxiliary contacts fitted	Type	Order code	Weight
Rated operational current $\theta \leq 40^\circ\text{C}$ AC-1	General use rating 600 V AC	Uc min. ... Uc max.					Pkg (1 pce)
A	A	V 50/60 Hz	V DC	 			kg

4 N.O. main poles

Rated operational current (A)	General use rating (A)	Uc min. (V 50/60 Hz)	Uc max. (V DC)	NO	NC	Type	Order code	Weight (kg)
25	25	-	12...20	0	0	AF09Z-40-00-20	1SBL136201R2000	0.310
		24...60	20...60	0	0	AF09Z-40-00-21	1SBL136201R2100	0.310
		48...130	48...130	0	0	AF09Z-40-00-22	1SBL136201R2200	0.310
		100...250	100...250	0	0	AF09Z-40-00-23	1SBL136201R2300	0.310
30	30	-	12...20	0	0	AF16Z-40-00-20	1SBL176201R2000	0.310
		24...60	20...60	0	0	AF16Z-40-00-21	1SBL176201R2100	0.310
		48...130	48...130	0	0	AF16Z-40-00-22	1SBL176201R2200	0.310
		100...250	100...250	0	0	AF16Z-40-00-23	1SBL176201R2300	0.310
45	45	-	12...20	0	0	AF26Z-40-00-20	1SBL236201R2000	0.400
		24...60	20...60	0	0	AF26Z-40-00-21	1SBL236201R2100	0.400
		48...130	48...130	0	0	AF26Z-40-00-22	1SBL236201R2200	0.400
		100...250	100...250	0	0	AF26Z-40-00-23	1SBL236201R2300	0.400
55	55	-	12...20	0	0	AF38Z-40-00-20	1SBL296201R2000	0.400
		24...60	20...60	0	0	AF38Z-40-00-21	1SBL296201R2100	0.400
		48...130	48...130	0	0	AF38Z-40-00-22	1SBL296201R2200	0.400
		100...250	100...250	0	0	AF38Z-40-00-23	1SBL296201R2300	0.400

2 N.O. + 2 N.C. main poles

Rated operational current (A)	General use rating (A)	Uc min. (V 50/60 Hz)	Uc max. (V DC)	NO	NC	Type	Order code	Weight (kg)
25	25	-	12...20	0	0	AF09Z-22-00-20	1SBL136501R2000	0.310
		24...60	20...60	0	0	AF09Z-22-00-21	1SBL136501R2100	0.310
		48...130	48...130	0	0	AF09Z-22-00-22	1SBL136501R2200	0.310
		100...250	100...250	0	0	AF09Z-22-00-23	1SBL136501R2300	0.310
30	30	-	12...20	0	0	AF16Z-22-00-20	1SBL176501R2000	0.310
		24...60	20...60	0	0	AF16Z-22-00-21	1SBL176501R2100	0.310
		48...130	48...130	0	0	AF16Z-22-00-22	1SBL176501R2200	0.310
		100...250	100...250	0	0	AF16Z-22-00-23	1SBL176501R2300	0.310
45	45	-	12...20	0	0	AF26Z-22-00-20	1SBL236501R2000	0.400
		24...60	20...60	0	0	AF26Z-22-00-21	1SBL236501R2100	0.400
		48...130	48...130	0	0	AF26Z-22-00-22	1SBL236501R2200	0.400
		100...250	100...250	0	0	AF26Z-22-00-23	1SBL236501R2300	0.400
55	55	-	12...20	0	0	AF38Z-22-00-20	1SBL296501R2000	0.400
		24...60	20...60	0	0	AF38Z-22-00-21	1SBL296501R2100	0.400
		48...130	48...130	0	0	AF38Z-22-00-22	1SBL296501R2200	0.400
		100...250	100...250	0	0	AF38Z-22-00-23	1SBL296501R2300	0.400

Note: Only AF.Z contactors with DC control voltage 12...20 V DC need to respect the connection polarities indicated close to the coil terminals: A1+ for the positive pole and A2- for the negative pole.

Main dimensions mm, inches

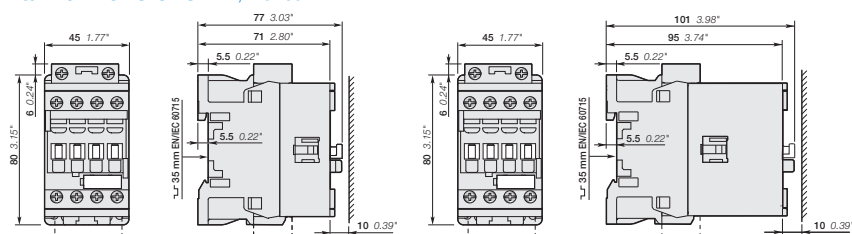

AF09Z, AF16Z

AF26Z, AF38Z

AF09 ... AF38 4-pole contactors

Main accessories

Contactor and main accessories (other accessories available)

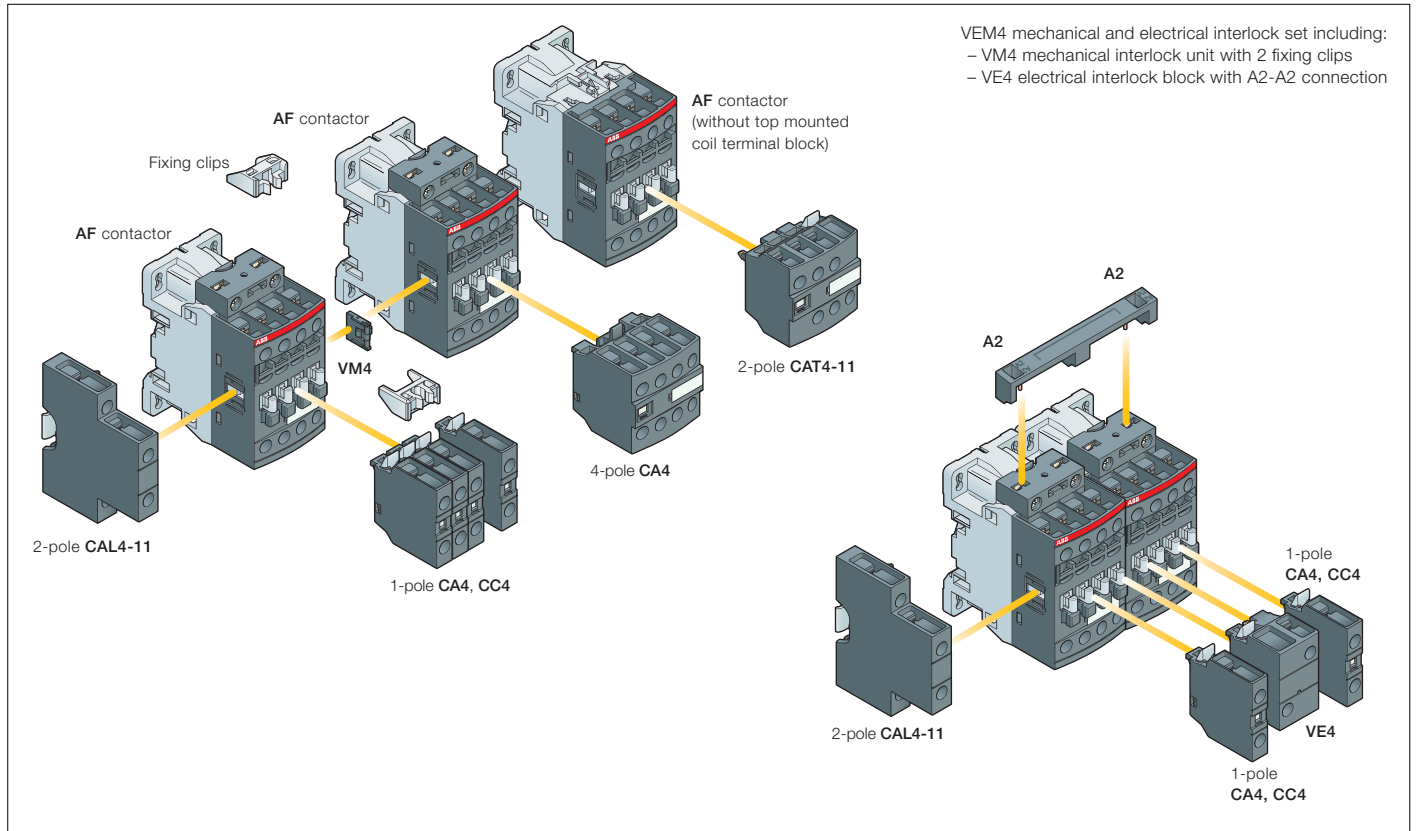

Main accessory fitting details

Many configurations of accessories are possible depending on whether these are front-mounted or side-mounted.

Contactor types	Main poles	Built-in auxiliary contacts	Front-mounted accessories				Electrical and mechanical interlock set (between 2 contactors)		Side-mounted accessories	
			Auxiliary contact blocks			VEM4	Auxiliary contact blocks			
			1-pole CA4 1-pole CC4	2-pole CAT4-11	4-pole CA4			Left side 2-pole CAL4-11	Right side	
Max. add-on N.C. auxiliary contacts: 4 N.C. max. on positions 1, 2, 3, 4 and 3 N.C. max. on positions 1 ±30°, 5										
AF09, AF16	4	0	0	4 max.	or 1	or 1	–	+ 1	–	
				2 max.	or 1	–	–	+ 1	+ 1	
				3 max.	–	–	+ 1	+ 1	or 1	
Max. add-on N.C. auxiliary contacts: 3 N.C. max. on positions 1, 2, 3, 4 and 2 N.C. max. on positions 1 ±30°, 5										
AF26, AF38	4	0	0	4 max.	or 1	or 1	–	+ 1	–	
				2 max.	or 1	–	–	+ 1	+ 1	
				3 max.	–	–	+ 1	+ 1	or 1	
AF09, AF16	2	2	0	4 max.	or 1	or 1	–	+ 1	–	
				2 max.	or 1	–	–	+ 1	+ 1	
AF26, AF38	2	2	0	2 max.	or 1	–	–	+ 1	+ 1	

AF09 ... AF38 4-pole contactors

Main accessories



CA4-10



CAL4-11



CA4-22E



CAT4-11E

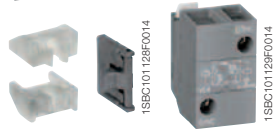

VEM4

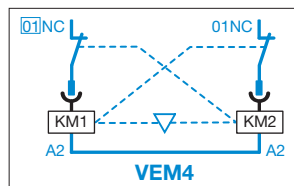

LDC4



BX4



BX4-CA

Ordering details (1)

For contactors	Auxiliary contacts	Type	Order code	Pkg qty	Weight (1 pce)
					kg

Front-mounted instantaneous auxiliary contact blocks

AF09 ... AF38...-40-00	1 0	- -	CA4-10	1SBN010110R1010	1	0.014
AF09 ... AF38...-22-00	1 0	- -	CA4-10-T	1SBN010110T1010	10	0.014
	0 1	- -	CA4-01	1SBN010110R1001	1	0.014
	0 1	- -	CA4-01-T	1SBN010110T1001	10	0.014
	2 2	- -	CA4-22E	1SBN010140R1022	1	0.055
	3 1	- -	CA4-31E	1SBN010140R1031	1	0.055
	4 0	- -	CA4-40E	1SBN010140R1040	1	0.055
AF09 ... AF16...-40-00	0 4	- -	CA4-04E	1SBN010140R1004	1	0.055

Front-mounted auxiliary contact blocks with N.O. leading contact and N.C. lagging contact

AF09 ... AF38...-40-00	- -	1 0	CC4-10	1SBN010111R1010	1	0.014
AF09 ... AF38...-22-00	- -	0 1	CC4-01	1SBN010111R1001	1	0.014

Side-mounted instantaneous auxiliary contact blocks

AF09 ... AF38...-40-00	1 1	- -	CAL4-11	1SBN010120R1011	1	0.040
AF09 ... AF38...-22-00	1 1	- -	CAL4-11-T	1SBN010120T1011	10	0.040

Front-mounted instantaneous auxiliary contact and A1/A2 coil terminal blocks

AF09 ... AF38...-40-00	1 1	- -	CAT4-11E	1SBN010151R1011	1	0.040
AF09 ... AF38...-22-00						

Note: CAT4 not fittable on AF..Z contactors with DC control voltage 12...20 V DC.

Mechanical interlock unit

AF09 ... AF38...-40-00			VM4	1SBN030105T1000	10	0.005
------------------------	--	--	-----	-----------------	----	-------

Note: VM4 includes 2 fixing clips (BB4) to maintain together both contactors.

Mechanical and electrical interlock set

AF09, AF16...-40-00	1 1	- -	VEM4	1SBN030111R1000	1	0.035
AF26, AF38...-40-00						

Note: - VEM4 includes a VM4 mechanical interlock unit with 2 fixing clips (BB4), a VE4 electrical interlock block. VE4 block must be used with A2-A2 connection to respect the electrical connection diagram.

- VEM4 not fittable on AF..Z contactors with DC control voltage 12...20 V DC.

Additional coil terminal block

AF09 ... AF38			LDC4	1SBN070156T1000	10	0.010
---------------	--	--	------	-----------------	----	-------

Protective covers

All 1-stack contactors			BX4	1SBN110108T1000	10	0.006
For 4-pole CA4 and 2-pole CAT4 auxiliary contact blocks			BX4-CA	1SBN110109W1000	50	0.001

(1) See "Main accessory fitting details" table.

A45 ... A75 4-pole contactors

70 to 125 A AC-1

AC operated

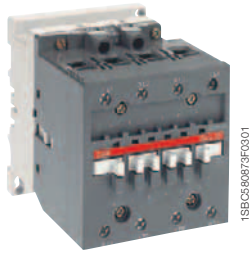

A45-40-00

Description

A45 ... A75 4-pole contactors are mainly used for controlling non-inductive or slightly inductive loads (i.e. resistance furnaces...) and generally for controlling power circuits up to 690 V AC and 220 V DC.

These contactors are of the block type design with:

- 4 main poles
- control circuit: AC operated
- add-on auxiliary contact blocks for front or side mounting and a wide range of accessories.

Ordering details

IEC	UL/CSA	Rated control circuit voltage U_c		Auxiliary contacts fitted	Type	Order code	Weight
Rated operational current $\theta \leq 40^\circ\text{C}$ AC-1	General use rating 600 V AC	V 50 Hz	V 60 Hz				Pkg (1 pce) kg

4 N.O. main poles

Rated operational current	General use rating	V 50 Hz	V 60 Hz	Auxiliary contacts	Type	Order code	Weight
70	80	24	24	0 0	A45-40-00	1SBL331201R8100	1.390
		48	48	0 0	A45-40-00	1SBL331201R8300	1.390
		110	110...120	0 0	A45-40-00	1SBL331201R8400	1.390
		220...230	230...240	0 0	A45-40-00	1SBL331201R8000	1.390
		230...240	240...260	0 0	A45-40-00	1SBL331201R8800	1.390
		380...400	400...415	0 0	A45-40-00	1SBL331201R8500	1.390
		400...415	415...440	0 0	A45-40-00	1SBL331201R8600	1.390
100	80	24	24	0 0	A50-40-00	1SBL351201R8100	1.390
		48	48	0 0	A50-40-00	1SBL351201R8300	1.390
		110	110...120	0 0	A50-40-00	1SBL351201R8400	1.390
		220...230	230...240	0 0	A50-40-00	1SBL351201R8000	1.390
		230...240	240...260	0 0	A50-40-00	1SBL351201R8800	1.390
		380...400	400...415	0 0	A50-40-00	1SBL351201R8500	1.390
		400...415	415...440	0 0	A50-40-00	1SBL351201R8600	1.390
125	105	24	24	0 0	A75-40-00	1SBL411201R8100	1.390
		48	48	0 0	A75-40-00	1SBL411201R8300	1.390
		110	110...120	0 0	A75-40-00	1SBL411201R8400	1.390
		220...230	230...240	0 0	A75-40-00	1SBL411201R8000	1.390
		230...240	240...260	0 0	A75-40-00	1SBL411201R8800	1.390
		380...400	400...415	0 0	A75-40-00	1SBL411201R8500	1.390
		400...415	415...440	0 0	A75-40-00	1SBL411201R8600	1.390

2 N.O. + 2 N.C. main poles (2)

Rated operational current	General use rating	V 50 Hz	V 60 Hz	Auxiliary contacts	Type	Order code	Weight
70	80	24	24	0 0	A45-22-00	1SBL331501R8100	1.400
		48	48	0 0	A45-22-00	1SBL331501R8300	1.400
		110	110...120	0 0	A45-22-00	1SBL331501R8400	1.400
		220...230	230...240	0 0	A45-22-00	1SBL331501R8000	1.400
		230...240	240...260	0 0	A45-22-00	1SBL331501R8800	1.400
		380...400	400...415	0 0	A45-22-00	1SBL331501R8500	1.400
		400...415	415...440	0 0	A45-22-00	1SBL331501R8600	1.400
125	105	24	24	0 0	A75-22-00	1SBL411501R8100	1.400
		48	48	0 0	A75-22-00	1SBL411501R8300	1.400
		110	110...120	0 0	A75-22-00	1SBL411501R8400	1.400
		220...230	230...240	0 0	A75-22-00	1SBL411501R8000	1.400
		230...240	240...260	0 0	A75-22-00	1SBL411501R8800	1.400
		380...400	400...415	0 0	A75-22-00	1SBL411501R8500	1.400
		400...415	415...440	0 0	A75-22-00	1SBL411501R8600	1.400

(1) Other control voltages see voltage code table.

(2) These contactors are not suitable for a reversing starter or star-delta starter or for controlling a single load from 2 separate supplies. Please see technical data.

Main dimensions mm, inches

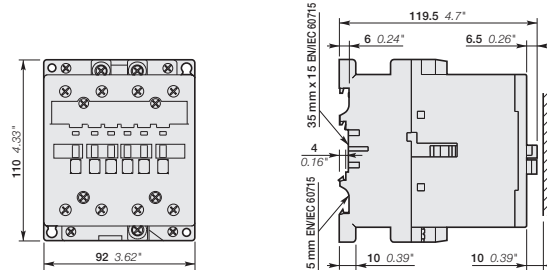

A45, A50, A75 4-pole

AE45 ... AE75 4-pole contactors

70 to 125 A AC-1

DC operated

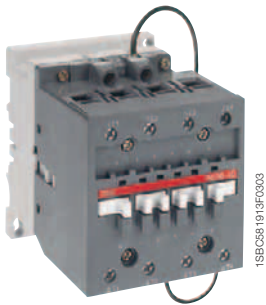

AE50-40-00

1SBC36191R03003

Description

AE45 ... AE75 4-pole contactors are mainly used for controlling non-inductive or slightly inductive loads (i.e. resistance furnaces...) and generally for controlling power circuits up to 690 V AC and 220 V DC.

These contactors are of the block type design with:

- 4 main poles
- control circuit: DC operated with double winding coil (and factory-mounted lagging contact for "holding" winding insertion)
- add-on auxiliary contact blocks for front or side mounting and a wide range of accessories.

Ordering details

IEC	UL/CSA	Rated control circuit voltage U _c	Auxiliary contacts fitted	Type	Order code	Weight
Rated operational current θ ≤ 40 °C AC-1	General use rating 600 V AC	(1)				Pkg (1 pce)
A	A	V DC				kg
4 N.O. main poles						
70	80	12	0 0	AE45-40-00	1SBL339201R8000	1.430
		24	0 0	AE45-40-00	1SBL339201R8100	1.430
		48	0 0	AE45-40-00	1SBL339201R8300	1.430
		60	0 0	AE45-40-00	1SBL339201R8400	1.430
		110	0 0	AE45-40-00	1SBL339201R8600	1.430
		125	0 0	AE45-40-00	1SBL339201R8700	1.430
		220	0 0	AE45-40-00	1SBL339201R8800	1.430
		240	0 0	AE45-40-00	1SBL339201R8900	1.430
100	80	12	0 0	AE50-40-00	1SBL359201R8000	1.430
		24	0 0	AE50-40-00	1SBL359201R8100	1.430
		48	0 0	AE50-40-00	1SBL359201R8300	1.430
		60	0 0	AE50-40-00	1SBL359201R8400	1.430
		110	0 0	AE50-40-00	1SBL359201R8600	1.430
		125	0 0	AE50-40-00	1SBL359201R8700	1.430
		220	0 0	AE50-40-00	1SBL359201R8800	1.430
		240	0 0	AE50-40-00	1SBL359201R8900	1.430
125	105	12	0 0	AE75-40-00	1SBL419201R8000	1.430
		24	0 0	AE75-40-00	1SBL419201R8100	1.430
		48	0 0	AE75-40-00	1SBL419201R8300	1.430
		60	0 0	AE75-40-00	1SBL419201R8400	1.430
		110	0 0	AE75-40-00	1SBL419201R8600	1.430
		125	0 0	AE75-40-00	1SBL419201R8700	1.430
		220	0 0	AE75-40-00	1SBL419201R8800	1.430
		240	0 0	AE75-40-00	1SBL419201R8900	1.430
2 N.O. + 2 N.C. main poles (2)						
70	80	12	0 0	AE45-22-00	1SBL339501R8000	1.440
		24	0 0	AE45-22-00	1SBL339501R8100	1.440
		48	0 0	AE45-22-00	1SBL339501R8300	1.440
		60	0 0	AE45-22-00	1SBL339501R8400	1.440
		110	0 0	AE45-22-00	1SBL339501R8600	1.440
		125	0 0	AE45-22-00	1SBL339501R8700	1.440
		220	0 0	AE45-22-00	1SBL339501R8800	1.440
		240	0 0	AE45-22-00	1SBL339501R8900	1.440
125	105	12	0 0	AE75-22-00	1SBL419501R8000	1.440
		24	0 0	AE75-22-00	1SBL419501R8100	1.440
		48	0 0	AE75-22-00	1SBL419501R8300	1.440
		60	0 0	AE75-22-00	1SBL419501R8400	1.440
		110	0 0	AE75-22-00	1SBL419501R8600	1.440
		125	0 0	AE75-22-00	1SBL419501R8700	1.440
		220	0 0	AE75-22-00	1SBL419501R8800	1.440
		240	0 0	AE75-22-00	1SBL419501R8900	1.440

(1) Other control voltages see voltage code table.

(2) These contactors are not suitable for a reversing starter or star-delta starter or for controlling a single load from 2 separate supplies. Please see technical data.

Main dimensions mm, inches

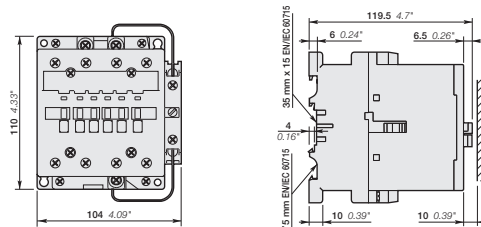

AE45, AE50, AE75 4-pole

1SBC101378S0201

AF45 ... AF75 4-pole contactors

70 to 125 A AC-1

AC / DC operated

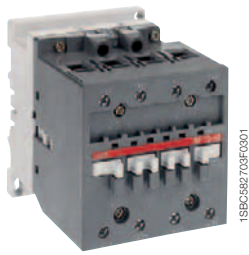

AF45-40-00

Description

AF45 ... AF75 4-pole contactors are mainly used for controlling non-inductive or slightly inductive loads (i.e. resistance furnaces...) and generally for controlling power circuits up to 690 V AC and 220 V DC.

These contactors are of the block type design with:

- 4 main poles
- control circuit: AC or DC operated with electronic coil interface accepting a wide control voltage range (e.g. 100...250 V AC and DC)
 - can manage large control voltage variations
 - only 3 coils to cover control voltages between 48...250 V 50/60 Hz and 20...250 V DC
 - reduced panel energy consumption
 - very distinct closing and opening
 - can withstand short voltage dips and voltage sags (SEMI F47 conditions of use on request).
- built-in surge suppression
- add-on auxiliary contact blocks for front or side mounting and a wide range of accessories.

Ordering details

IEC	UL/CSA	Rated control circuit voltage Uc min. ... Uc max.		Auxiliary contacts fitted		Type	Order code	Weight
Rated operational current $\theta \leq 40^\circ\text{C}$ AC-1	General use rating 600 V AC	V 50/60 Hz	V DC	1	2			Pkg (1 pce) kg
4 N.O. main poles								
70	80	-	20...60	0	0	AF45-40-00	1SBL337201R7200 (1)	1.420
		48...130	48...130	0	0	AF45-40-00	1SBL337201R6900	1.420
		100...250	100...250	0	0	AF45-40-00	1SBL337201R7000	1.420
100	80	-	20...60	0	0	AF50-40-00	1SBL357201R7200 (1)	1.420
		48...130	48...130	0	0	AF50-40-00	1SBL357201R6900	1.420
		100...250	100...250	0	0	AF50-40-00	1SBL357201R7000	1.420
125	105	-	20...60	0	0	AF75-40-00	1SBL417201R7200 (1)	1.420
		48...130	48...130	0	0	AF75-40-00	1SBL417201R6900	1.420
		100...250	100...250	0	0	AF75-40-00	1SBL417201R7000	1.420
2 N.O. + 2 N.C. main poles (2)								
70	80	-	20...60	0	0	AF45-22-00	1SBL337501R7200 (1)	1.420
		48...130	48...130	0	0	AF45-22-00	1SBL337501R6900	1.420
		100...250	100...250	0	0	AF45-22-00	1SBL337501R7000	1.420
125	105	-	20...60	0	0	AF75-22-00	1SBL417501R7200 (1)	1.420
		48...130	48...130	0	0	AF75-22-00	1SBL417501R6900	1.420
		100...250	100...250	0	0	AF75-22-00	1SBL417501R7000	1.420

(1) The connection polarities indicated close to the coil terminals must be respected: A1 for the positive pole and A2 for the negative pole.

(2) These contactors are not suitable for a reversing starter or star-delta starter or for controlling a single load from 2 separate supplies. Please see technical data.

Main dimensions mm, inches

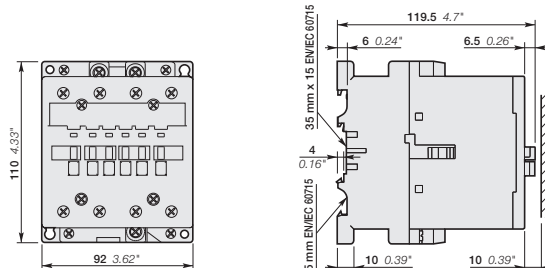

AF45, AF50, AF75 4-pole

A45 ... A75, AE and AF45 ... AF75 4-pole contactors

Main accessories

Contactor and main accessories (other accessories available)

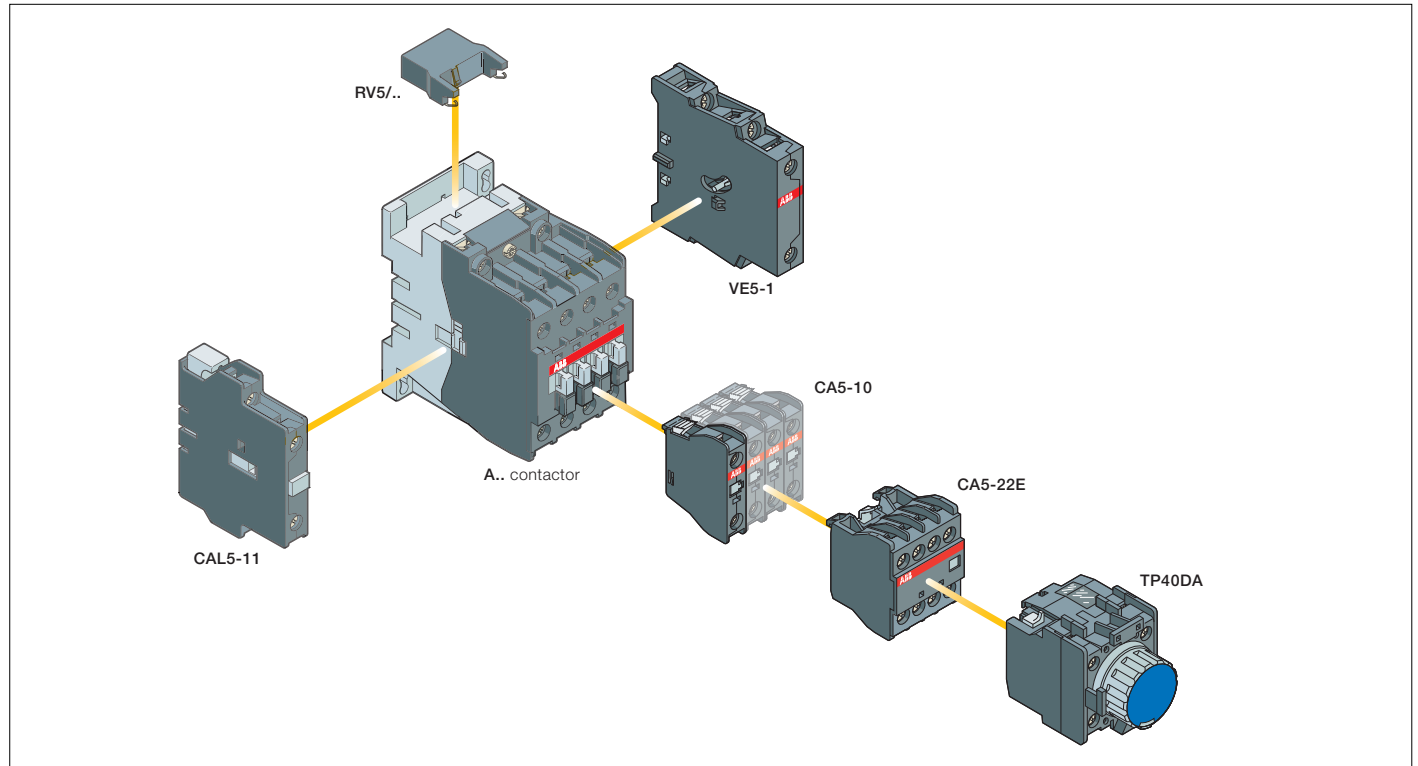

Main accessory fitting details

Many configurations of accessories are possible depending on whether these are front-mounted or side-mounted.

Contactor types	Main poles	Available auxiliary contacts	Front-mounted accessories		Side-mounted accessories		
			Auxiliary contact blocks	Pneumatic timer	Auxiliary contact blocks	Interlock unit	
			1-pole CA5-...	4-pole CA5-...	TP. A	2-pole CAL5-11	VE5-...
A45 ... A75	4 0 0 0	0 0 0	1 to 6 x CA5-...	or 1 x CA5-... (4-pole) + 2 x 1-pole CA5-...	or 1 x TP .. A + 2 x CA5-... (1-pole)	+ 1 to 2 x CAL5-11	or 1 x VE5-2 + 1 x CAL5-11
	2 2 0 0 (1)	0 0 (1)	1 to 6 x CA5-...	or 1 x CA5-... (4-pole) + 2 x 1-pole CA5-...	or 1 x TP .. A + 2 x CA5-... (1-pole)	+ 1 to 2 x CAL5-11	-
AE45 ... AE75	4 0 0 0	0 0 0	1 to 6 x CA5-...	or 1 x CA5-... (4-pole) + 2 x 1-pole CA5-...	or 1 x TP .. A + 2 x CA5-... (1-pole)	+ 1 x CAL5-11	or 1 x VE5-2
	2 2 0 0 (1)	0 0 (1)	1 to 6 x CA5-...	or 1 x CA5-... (4-pole) + 2 x 1-pole CA5-...	or 1 x TP .. A + 2 x CA5-... (1-pole)	+ 1 x CAL5-11	-
AF50 ... AF75	4 0 0 0	0 0 0	1 to 6 x CA5-...	or 1 x CA5-... (4-pole) + 2 x 1-pole CA5-...	or 1 x TP .. A + 2 x CA5-... (1-pole)	+ 1 to 2 x CAL5-11	or 1 x VE5-2 + 1 x CAL5-11
	2 2 0 0 (1)	0 0 (1)	1 to 6 x CA5-...	or 1 x CA5-... (4-pole) + 2 x 1-pole CA5-...	or 1 x TP .. A + 2 x CA5-... (1-pole)	+ 1 to 2 x CAL5-11	-

(1) 2 x N.C. CA 5-... auxiliary contacts maximum.

A45 ... A75, AE and AF50 ... AF75 4-pole contactors

Main accessories



CA5-10



CAL5-11



RV5/50



TP40DA

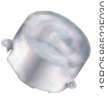

BX-TP

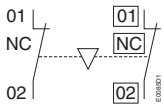

VE5-2

Terminal marking and positioning

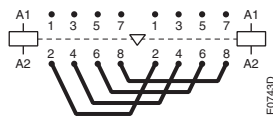

BES... for 4 N.O. main pole connection

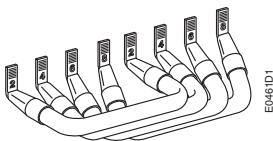

BES75-40

Ordering details (1)

For contactors	Auxiliary contacts	Type	Order code	Pkg qty	Weight (1 pce)
					kg

Front-mounted instantaneous auxiliary contact blocks

A45 ... A75, AE45 ... AE75, AF50 ... AF75	1 -	CA5-10	1SBN010010R1010	10	0.014
	- 1	CA5-01	1SBN010010R1001	10	0.014
A45 ... A75, AE45 ... AE75, AF45 ... AF75	2 2	CA5-22E	1SBN010040R1022	2	0.060

Side-mounted instantaneous auxiliary contact blocks

A45 ... A75, AE45 ... AE75, AF45 ... AF75	1 1	CAL5-11	1SBN010020R1011	2	0.050
---	-----	---------	-----------------	---	-------

Pneumatic timer blocks

A45 ... A75,	delay on energization	0.1...40 s	1 1	TP40DA	1SBN020300R1000	1	0.070
AE45 ... AE75,	10...180 s	1 1	TP180DA	1SBN020300R1001	1	0.070	
AF45 ... AF75	delay on de-energization	0.1...40 s	1 1	TP40IA	1SBN020301R1000	1	0.070
	10...180 s	1 1	TP180IA	1SBN020301R1001	1	0.070	
Timer accessory	plastic sealable cover	- -	BX-TP	FPTN472657R0001	1	0.006	

Interlock unit

A45 ... A75-40-00, AF45 ... AF75-40-00	Mechanical and electrical	- 2	VE5-2	1SBN030210R1000	1	0.146
--	---------------------------	-----	-------	-----------------	---	-------

Surge suppressors

For contactors	Rated control circuit voltage U _c		Type	Order code	Pkg qty	Weight (1 pce)
	V	AC DC				
A45 ... A75, AE45 ... AE75	24...50	● ●	RV5/50	1SBN050010R1000	2	0.015
	50...133	● ●	RV5/133	1SBN050010R1001	2	0.015
	110...250	● ●	RV5/250	1SBN050010R1002	2	0.015
	250...440	● ●	RV5/440	1SBN050010R1003	2	0.015
A45 ... A75	24...50	● -	RC5-2/50	1SBN050200R1000	2	0.015
	50...133	● -	RC5-2/133	1SBN050200R1001	2	0.015
	110...250	● -	RC5-2/250	1SBN050200R1002	2	0.015
	250...440	● -	RC5-2/440	1SBN050200R1003	2	0.015
AE45 ... AE75	12...32	- ●	RT5/32	1SBN050020R1000	2	0.015
	25...65	- ●	RT5/65	1SBN050020R1001	2	0.015
	50...90	- ●	RT5/90	1SBN050020R1002	2	0.015
	77...150	- ●	RT5/150	1SBN050020R1003	2	0.015
	150...264	- ●	RT5/264	1SBN050020R1004	2	0.015

Connection sets for 4-pole changeover contactors

A45 ... A75-40-00, AE45 ... AE75-40-00, AF45 ... AF75-40-00	BES75-40	1SBN083302R1000	1	0.400
---	----------	-----------------	---	-------

(1) See "Main accessory fitting details" table.

EK110 ... EK150 4-pole contactors

200 to 250 A AC-1

AC operated - with 1 N.O. + 1 N.C. auxiliary contacts



18BC5734/01F0301



EK150-40-11

Description

EK110 ... EK150 4-pole contactors are mainly used for controlling non-inductive or slightly inductive loads (i.e. resistance furnaces...) and for controlling power circuits up to 1000 V AC and 440 V DC. These contactors are of the block type design with:

- 4 main poles
- control circuit: AC operated
- add-on auxiliary contact blocks for side mounting and a wide range of accessories.

Ordering details

IEC Rated operational current $\theta \leq 40^\circ\text{C}$ AC-1 A	UL/CSA General use rating 600 V AC A	Rated control circuit voltage Uc (1)		Auxiliary contacts fitted		Type	Order code	Weight Pkg (1 pce) kg
		V 50 Hz	V 60 Hz					
200	170	48	-	1	1	EK110-40-11	SK824440-AD	4.300
		-	110	1	1	EK110-40-11	SK824440-AE	4.300
		110	120	1	1	EK110-40-11	SK824440-AF	4.300
		220...230	-	1	1	EK110-40-11	SK824440-AL	4.300
		230...240	-	1	1	EK110-40-11	SK824440-AM	4.300
		-	380	1	1	EK110-40-11	SK824440-AN	4.300
		380...400	440	1	1	EK110-40-11	SK824440-AP	4.300
		400...415	-	1	1	EK110-40-11	SK824440-AR	4.300
250	200	48	-	1	1	EK150-40-11	SK824441-AD	4.350
		-	110	1	1	EK150-40-11	SK824441-AE	4.350
		110	120	1	1	EK150-40-11	SK824441-AF	4.350
		220...230	-	1	1	EK150-40-11	SK824441-AL	4.350
		230...240	-	1	1	EK150-40-11	SK824441-AM	4.350
		-	380	1	1	EK150-40-11	SK824441-AN	4.350
		380...400	440	1	1	EK150-40-11	SK824441-AP	4.350
		400...415	-	1	1	EK150-40-11	SK824441-AR	4.350

(1) Other control voltages see voltage code table.

Main dimensions mm, inches

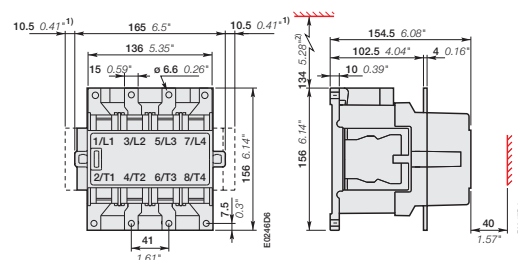

EK110

- 1) Dimension for extra auxiliary contact block.
- 2) Min. distance to uninsulated wall.

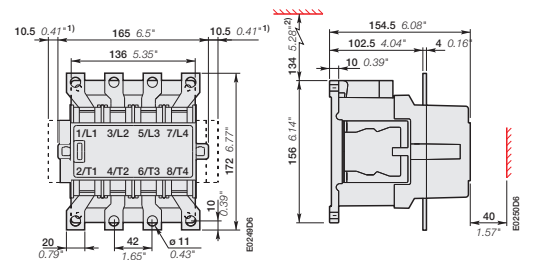

EK150

EK110 ... EK150 4-pole contactors

200 to 250 A AC-1

DC operated - with 2 N.O. + 1 N.C. auxiliary contacts



EK150-40-21

Description

EK110 ... EK150 4-pole contactors are mainly used for controlling non-inductive or slightly inductive loads (i.e. resistance furnaces...) and for controlling power circuits up to 1000 V AC and 440 V DC.

These contactors are of the block type design with:

- 4 main poles
- control circuit: DC operated
- add-on auxiliary contact blocks for side mounting and a wide range of accessories.

Ordering details

IEC Rated operational current $\theta \leq 40^\circ\text{C}$ AC-1 A	UL/CSA General use rating 600 V AC A	Rated control circuit voltage Uc VDC	Auxiliary contacts fitted 	Type	Order code	Weight Pkg (1 pce) kg
200	170	12	2 1	EK110-40-21	SK824440-DA	4.350
		24	2 1	EK110-40-21	SK824440-DB	4.350
		36	2 1	EK110-40-21	SK824440-DC	4.350
		48	2 1	EK110-40-21	SK824440-DD	4.350
		60	2 1	EK110-40-21	SK824440-DT	4.350
		75	2 1	EK110-40-21	SK824440-DG	4.350
		110	2 1	EK110-40-21	SK824440-DE	4.350
		125	2 1	EK110-40-21	SK824440-DU	4.350
250	200	220	2 1	EK110-40-21	SK824440-DF	4.350
		12	2 1	EK150-40-21	SK824441-DA	4.400
		24	2 1	EK150-40-21	SK824441-DB	4.400
		36	2 1	EK150-40-21	SK824441-DC	4.400
		48	2 1	EK150-40-21	SK824441-DD	4.400
		60	2 1	EK150-40-21	SK824441-DT	4.400
		75	2 1	EK150-40-21	SK824441-DG	4.400
		110	2 1	EK150-40-21	SK824441-DE	4.400
125	2 1	EK150-40-21	SK824441-DU	4.400		
		220	2 1	EK150-40-21	SK824441-DF	4.400

5

Main dimensions mm, inches

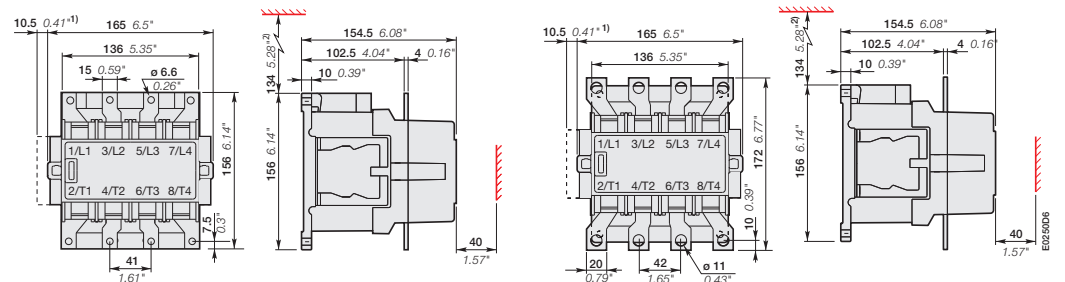

EK110

- 1) Dimension for extra auxiliary contact block.
- 2) Min. distance to uninsulated wall.

EK150

EK175 ... EK550 4-pole contactors

300 to 800 A AC-1

AC operated - with 1 N.O. + 1 N.C. auxiliary contacts



1360579426F0301

EK370-40-11



Description

EK175 ... EK550 4-pole contactors are mainly used for controlling non-inductive or slightly inductive loads (i.e. resistance furnaces...) and for controlling power circuits up to 1000 V AC and 600 V DC.

These contactors are of the block type design with:

- 4 main poles
- control circuit: AC operated
- add-on auxiliary contact blocks for side mounting and a wide range of accessories.

Ordering details

IEC Rated operational current $\theta \leq 40^\circ\text{C}$ AC-1	UL/CSA General use rating 600 V AC	Rated control circuit voltage U_c (1)		Auxiliary contacts fitted		Type	Order code	Weight Pkg (1 pce) kg
		V 50 Hz	V 60 Hz					
300	250	48	-	1	1	EK175-40-11	SK825440-AD	6.600
		-	110	1	1	EK175-40-11	SK825440-AE	6.600
		110	120	1	1	EK175-40-11	SK825440-AF	6.600
		220...230	-	1	1	EK175-40-11	SK825440-AL	6.600
		230...240	-	1	1	EK175-40-11	SK825440-AM	6.600
		-	380	1	1	EK175-40-11	SK825440-AN	6.600
		380...400	440	1	1	EK175-40-11	SK825440-AP	6.600
		400...415	-	1	1	EK175-40-11	SK825440-AR	6.600
350	300	48	-	1	1	EK210-40-11	SK825441-AD	6.600
		-	110	1	1	EK210-40-11	SK825441-AE	6.600
		110	120	1	1	EK210-40-11	SK825441-AF	6.600
		220...230	-	1	1	EK210-40-11	SK825441-AL	6.600
		230...240	-	1	1	EK210-40-11	SK825441-AM	6.600
		-	380	1	1	EK210-40-11	SK825441-AN	6.600
		380...400	440	1	1	EK210-40-11	SK825441-AP	6.600
		400...415	-	1	1	EK210-40-11	SK825441-AR	6.600
550	420	48	-	1	1	EK370-40-11	SK827040-AD	17.200
		110	110...120	1	1	EK370-40-11	SK827040-EF	17.200
		110...115	115...127	1	1	EK370-40-11	SK827040-EG	17.200
		220	220...240	1	1	EK370-40-11	SK827040-EL	17.200
		220...230	230...255	1	1	EK370-40-11	SK827040-EM	17.200
		380	380...415	1	1	EK370-40-11	SK827040-EP	17.200
		380...400	400...440	1	1	EK370-40-11	SK827040-ER	17.200
		400...415	-	1	1	EK370-40-11	SK827040-AR	17.200
800	540	48	-	1	1	EK550-40-11	SK827041-AD	17.200
		110	110...120	1	1	EK550-40-11	SK827041-EF	17.200
		110...115	115...127	1	1	EK550-40-11	SK827041-EG	17.200
		220	220...240	1	1	EK550-40-11	SK827041-EL	17.200
		220...230	230...255	1	1	EK550-40-11	SK827041-EM	17.200
		380	380...415	1	1	EK550-40-11	SK827041-EP	17.200
		380...400	400...440	1	1	EK550-40-11	SK827041-ER	17.200
		400...415	-	1	1	EK550-40-11	SK827041-AR	17.200

(1) Other control voltages see voltage code table.

Main dimensions mm, inches

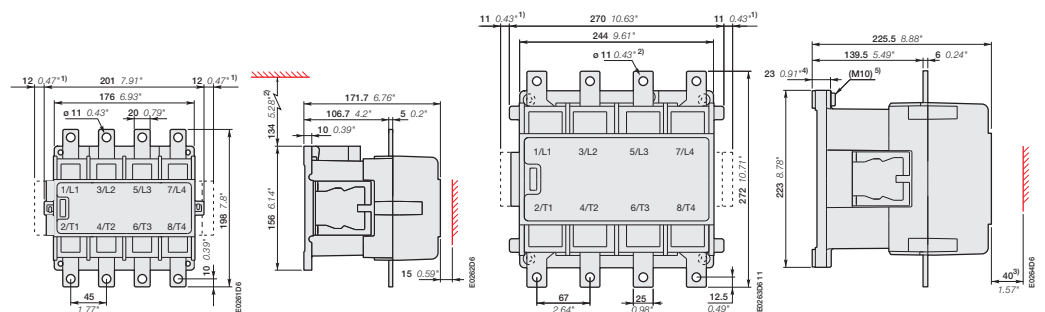

EK175, EK210

- 1) Dimension for extra auxiliary contact block.
- 2) Min. distance to uninsulated wall.

EK370, EK550

- 1) Dimension for extra auxiliary contact block.
- 2) Screw, nut and washer by-packed.
- 3) Min. distance to uninsulated wall.
- 4) Damping elements are included.
- 5) Earthing screw.

EK175 ... EK550 4-pole contactors

300 to 800 A AC-1

DC operated - with 2 N.O. + 1 N.C. auxiliary contacts



EK370-40-21

Description

EK175 ... EK550 4-pole contactors are mainly used for controlling non-inductive or slightly inductive loads (i.e. resistance furnaces...) and generally for controlling power circuits up to 1000 V AC and 600 V DC. These contactors are of the block type design with:

- 4 main poles
- control circuit: DC operated with
- add-on auxiliary contact blocks for side mounting and a wide range of accessories.

Ordering details

IEC Rated operational current $\theta \leq 40^\circ\text{C}$ AC-1 A	UL/CSA General use rating 600 V AC A	Rated control circuit voltage U_c V DC	Auxiliary contacts fitted 	Type	Order code	Weight Pkg (1 pce) kg		
300	250	12	2 1	EK175-40-21	SK825440-DA	6.650		
		24	2 1	EK175-40-21	SK825440-DB	6.650		
		36	2 1	EK175-40-21	SK825440-DC	6.650		
		48	2 1	EK175-40-21	SK825440-DD	6.650		
		60	2 1	EK175-40-21	SK825440-DT	6.650		
		75	2 1	EK175-40-21	SK825440-DG	6.650		
		110	2 1	EK175-40-21	SK825440-DE	6.650		
		125	2 1	EK175-40-21	SK825440-DU	6.650		
		220	2 1	EK175-40-21	SK825440-DF	6.650		
		350	300	12	2 1	EK210-40-21	SK825441-DA	6.650
24	2 1			EK210-40-21	SK825441-DB	6.650		
36	2 1			EK210-40-21	SK825441-DC	6.650		
48	2 1			EK210-40-21	SK825441-DD	6.650		
60	2 1			EK210-40-21	SK825441-DT	6.650		
75	2 1			EK210-40-21	SK825441-DG	6.650		
110	2 1			EK210-40-21	SK825441-DE	6.650		
125	2 1			EK210-40-21	SK825441-DU	6.650		
220	2 1			EK210-40-21	SK825441-DF	6.650		
550	420			24	2 1	EK370-40-21	SK827040-DB	17.200
		36	2 1	EK370-40-21	SK827040-DC	17.200		
		48	2 1	EK370-40-21	SK827040-DD	17.200		
		60	2 1	EK370-40-21	SK827040-DT	17.200		
		75	2 1	EK370-40-21	SK827040-DG	17.200		
		110	2 1	EK370-40-21	SK827040-DE	17.200		
		125	2 1	EK370-40-21	SK827040-DU	17.200		
		220	2 1	EK370-40-21	SK827040-DF	17.200		
		800	540	24	2 1	EK550-40-21	SK827041-DB	17.200
				36	2 1	EK550-40-21	SK827041-DC	17.200
48	2 1			EK550-40-21	SK827041-DD	17.200		
60	2 1			EK550-40-21	SK827041-DT	17.200		
75	2 1			EK550-40-21	SK827041-DG	17.200		
110	2 1			EK550-40-21	SK827041-DE	17.200		
125	2 1			EK550-40-21	SK827041-DU	17.200		
220	2 1			EK550-40-21	SK827041-DF	17.200		

Main dimensions mm, inches

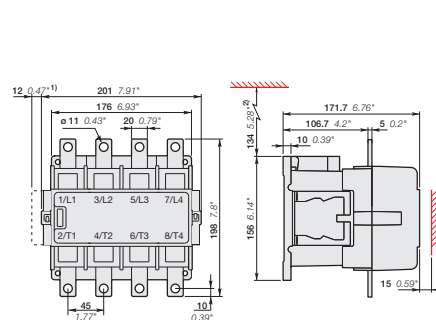

EK175 ... EK210

- 1) Dimension for extra auxiliary contact block.
- 2) Min. distance to uninsulated wall.

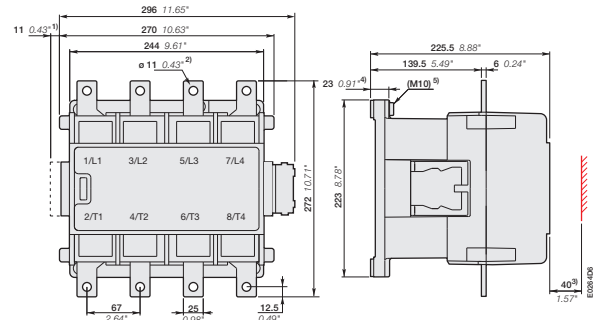

EK370 ... EK550

- 1) Dimension for extra auxiliary contact block.
- 2) Screw, nut and washer by-packed.
- 3) Min. distance to uninsulated wall.
- 4) Damping elements are included.
- 5) Earthing screw.

EK1000 4-pole contactors

1000 A AC-1

AC operated - with 1 N.O. + 1 N.C. auxiliary contacts

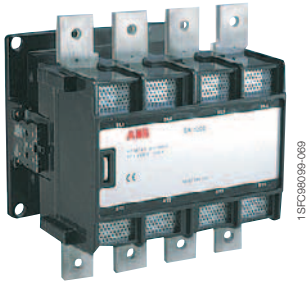

EK1000-40-11

Description

EK1000 4-pole contactors are mainly used for controlling non-inductive or slightly inductive loads (i.e. resistance furnaces...) and generally for controlling power circuits up to 1000 V AC.

These contactors are of the block type design with:

- 4 main poles
- control circuit: AC operated
- add-on auxiliary contact blocks for side mounting and a wide range of accessories.

Ordering details

IEC	UL/CSA	Rated control circuit voltage U_c		Auxiliary contacts fitted		Type	Order code	Weight
Rated operational current $\theta \leq 40^\circ\text{C}$ AC-1	General use rating 600 V AC	(1)						Pkg (1 pce)
A	A	V 50 Hz	V 60 Hz					kg
1000	-	48	-	1	1	EK1000-40-11	SK827044-AD	17.500
		110	110...120	1	1	EK1000-40-11	SK827044-EF	17.500
		110...115	115...127	1	1	EK1000-40-11	SK827044-EG	17.500
		220	220...240	1	1	EK1000-40-11	SK827044-EL	17.500
		220...230	230...255	1	1	EK1000-40-11	SK827044-EM	17.500
		380	380...415	1	1	EK1000-40-11	SK827044-EP	17.500
		380...400	400...440	1	1	EK1000-40-11	SK827044-ER	17.500
		400...415	-	1	1	EK1000-40-11	SK827044-AR	17.500

(1) Other control voltages see voltage code table.

Main dimensions mm, inches

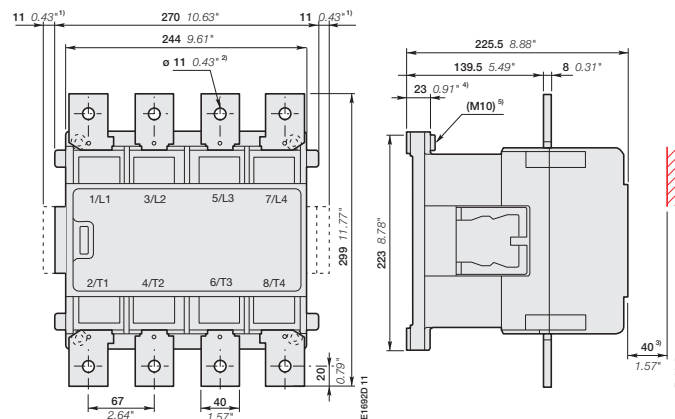

EK1000

- 1) Dimension for extra auxiliary contact block.
- 2) Screw, nut and washer by-packed.
- 3) Min. distance to uninsulated wall.
- 4) Damping elements are included.
- 5) Earthing screw.

EK1000 4-pole contactors

1000 A AC-1

DC operated - with 2 N.O. + 1 N.C. auxiliary contacts



EK1000-40-21

1SFC8039-089

Description

EK1000 4-pole contactors are mainly used for controlling non-inductive or slightly inductive loads (i.e. resistance furnaces...) and generally for controlling power circuits up to 1000 V AC.

These contactors are of the block type design with:

- 4 main poles
- control circuit: DC operated
- add-on auxiliary contact blocks for side mounting and a wide range of accessories.

Ordering details

IEC Rated operational current $\theta \leq 40^\circ\text{C}$ AC-1 A	UL/CSA General use rating 600 V AC A	Rated control circuit voltage Uc V DC	Auxiliary contacts fitted 	Type	Order code	Weight Pkg (1 pce) kg
1000	-	24	2 1	EK1000-40-21	SK827044-DB	17.500
		36	2 1	EK1000-40-21	SK827044-DC	17.500
		48	2 1	EK1000-40-21	SK827044-DD	17.500
		60	2 1	EK1000-40-21	SK827044-DT	17.500
		75	2 1	EK1000-40-21	SK827044-DG	17.500
		110	2 1	EK1000-40-21	SK827044-DE	17.500
		125	2 1	EK1000-40-21	SK827044-DU	17.500
		220	2 1	EK1000-40-21	SK827044-DF	17.500

Main dimensions mm, inches

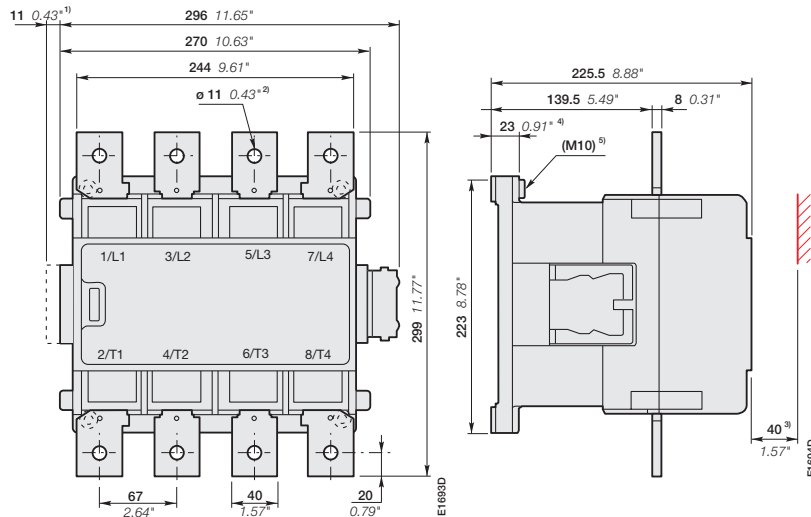

EK1000

- 1) Dimension for extra auxiliary contact block.
- 2) Screw, nut and washer by-packed.
- 3) Min. distance to uninsulated wall.
- 4) Damping elements are included.
- 5) Earthing screw.

1SFC101063C0201

EK110 ... EK1000 4-pole contactors with 1 N.O. + 1 N.C. auxiliary contacts and 2 N.O. + 1 N.C. auxiliary contacts

Main accessory fitting details

Mounting positions of the auxiliary contact

Auxiliary contact types and connecting diagrams

(1) Contact 35-36 used for some types of EK... contactors

EK... 4-pole contactors

Contactor types	Main poles	Available auxiliary contacts	Add-on auxiliary contact blocks	Mounting and positioning
			2-pole CAL16-11 ...	<div style="display: flex; justify-content: space-around;"> <div style="width: 15px; height: 15px; background-color: yellow; border: 1px solid black;"></div> Factory mounted auxiliary contacts <div style="width: 15px; height: 15px; background-color: orange; border: 1px solid black;"></div> Add-on CAL16-11 auxiliary contacts </div>
AC operated, 50 Hz, 60 Hz or 50/60 Hz				
EK110 ... EK1000	4 0 1 1		+ 1 x CAL16-11B + 1 x CAL16-11C + 1 x CAL16-11D	
AC operated, 40...400 Hz				
EK110 ... EK210	4 0 2 1		+ 1 x CAL16-11C	
DC operated				
EK110 ... EK1000	4 0 2 1		+ 1 x CAL16-11C	

EK ... 4-pole reversing contactors with VH145 / VH300 mechanical and electrical interlock units

"Left hand" contactors	Interlocking	"Right hand" contactors	Add-on auxiliary contact blocks	Mounting and positioning
			2-pole CAL16-11 ...	<div style="display: flex; justify-content: space-around;"> <div style="width: 15px; height: 15px; background-color: yellow; border: 1px solid black;"></div> Factory mounted auxiliary contacts <div style="width: 15px; height: 15px; background-color: orange; border: 1px solid black;"></div> Add-on CAL16-11 auxiliary contacts </div>
AC operated, 50 Hz, 60 Hz or 50/60 Hz				
EK110 ... EK150 EK175, EK210 EK370 ... EK1000	VH145 VH300 VH800	EK110, EK150 EK175, EK210 EK370 ... EK1000	+ 1 x CAL16-11C + 1 x CAL16-11D	
AC operated, 40...400 Hz				
EK110 ... EK150 EK175, EK210 EK370 ... EK1000	VH145 VH300 VH800	EK110, EK150 EK175, EK210 EK370 ... EK1000	–	
DC operated, 50 Hz, 60 Hz or 50/60 Hz				
EK110 ... EK150 EK175, EK210 EK370 ... EK1000	VH145 VH300 VH800	EK110, EK150 EK175, EK210 EK370 ... EK1000	–	

EK110 ... EK1000 4-pole contactors with 1 N.O. + 1 N.C. auxiliary contacts and 2 N.O. + 1 N.C. auxiliary contacts

Ordering details (1)

For contactors	Auxiliary contacts	Type	Order code	Pkg qty	Weight (1 pce)
					kg

Side-mounted auxiliary contact blocks

EK...	1	1	CAL16-11B	SK829002-B	1	0.050
	1	1	CAL16-11C	SK829002-C	1	0.050
	1	1	CAL16-11D	SK829002-D	1	0.050
	1	1	CCL16-11E (2)	SK829002-E	1	0.050

(2) Mounting of CCL16-11E blocks does not allow an additional second block to be added on top of it.
All DC operated EK... contactors are equipped with one CCL16-11E on the right side.



1SBC573499ZFO001

VH145

Mechanical and electrical interlock unit for two horizontal mounted contactors

EK110, EK150	VH145	SK829071-A	1	0.130
EK175, EK210	VH300	SK829071-B	1	0.130

Mechanical interlock unit for two horizontal mounted contactors

EK370 ... EK1000	VH800	SK829070-F	1	6.000
------------------	-------	------------	---	-------

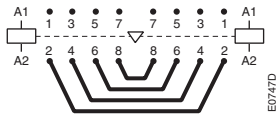

E0747D

BSS100 ... BSS100

Connecting sets

EK110	BSS100	SK829090-B	1	0.400
EK150	BSS145	SK829090-F	1	0.700
EK175, EK210	BSS210	SK829090-G	1	1.000
EK370, EK550	BSS550	SK829090-E	1	3.300
EK1000	BSS1000	SK829090-H	1	5.500



A078

RC-EH300/48

Surge suppressors

For contactors	Rated control circuit voltage U _c		Type	Order code	Pkg qty	Weight (1 pce)	
	V	AC					DC
EK110 ... EK210	24...48	●	-	RC-EH300/48	SK829007-A	1	0.015
	110...415	●	-	RC-EH300/415	SK829007-B	1	0.015
EK370 ... EK1000	48...110	●	-	RC-EH800/110	SK829007-C	1	0.015
EK110 ... EK1000	24...125	-	●	RC-EH800/110	SK829007-C	1	0.015
EK370 ... EK1000	220...600	●	-	RC-EH800/600	SK829007-D	1	0.015

(1) See "Main accessory fitting details" table.

AF09 ... AF38 4-pole contactors

Technical data

Main pole - Utilization characteristics according to IEC

Contactor types	AC / DC operated	AF09	AF16	AF26	AF38
Standards		IEC 60947-1 / 60947-4-1 and EN 60947-1 / 60947-4-1			
Rated operational voltage U_e max.		690 V			
Rated frequency (without derating)		50 / 60 Hz			
Conventional free-air thermal current I_{th}					
acc. to IEC 60947-4-1, open contactors, $\theta \leq 40^\circ\text{C}$		35 A	35 A	55 A	55 A
With conductor cross-sectional area		6 mm ²	6 mm ²	16 mm ²	16 mm ²
AC-1 Utilization category					
For air temperature close to contactor					
I_e / Rated operational current AC-1	$\theta \leq 40^\circ\text{C}$	25 A	30 A	45 A	55 A
U_e max. ≤ 690 V, 50/60 Hz	$\theta \leq 60^\circ\text{C}$	25 A	30 A	40 A	45 A
	$\theta \leq 70^\circ\text{C}$	22 A	26 A	32 A	37 A
With conductor cross-sectional area		4 mm ²	6 mm ²	10 mm ²	16 mm ²
Short-circuit protection device for contactors					
Without thermal overload relay - Motor protection excluded					
$U_e \leq 500$ V AC - gG type fuse		25 A	32 A	50 A	63 A
Rated short-time withstand current I_{cw}					
At 40 °C ambient temperature, in free air from a cold state	1 s	300 A	300 A	450 A	450 A
	10 s	150 A	150 A	300 A	300 A
	30 s	80 A	80 A	225 A	225 A
	1 min	60 A	60 A	150 A	150 A
	15 min	35 A	35 A	55 A	55 A
Power dissipation per pole	I_e / AC-1	0.8 W	1.2 W	1.6 W	2.3 W
Max. electrical switching frequency	AC-1	600 cycles/h			

Main pole - Utilization characteristics according to UL / CSA

Contactor types	AF09	AF16	AF26	AF38
Standards	UL 508, CSA C22.2 N°14			
Max. operational voltage	600 V			
UL / CSA general use rating				
600 V AC	25 A	30 A	45 A	55 A
With conductor cross-sectional area	AWG 10	AWG 10	AWG 8	AWG 6
Max. electrical switching frequency				
For general use	600 cycles/h			

Remark for 4-pole contactors fitted with 2 N.O. + 2 N.C. main poles

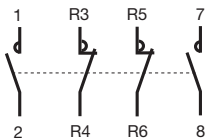

These contactors are suitable for controlling 2 separate circuits, i.e. 2 loads with 2 separate supplies, or 1 circuit comprising 2 separate loads with a single supply (see diagrams below). When the contactor operates there is no mechanical overlapping between the N.O. poles and the N.C. poles: BREAK before MAKE.



These contactors are not suitable for a reversing starter or for controlling a single load from 2 separate supplies.

Block diagrams

– Single supply and 2 separate loads

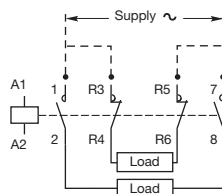

– 2 separate supplies and 2 separate loads

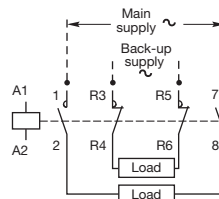

A45 ... A75, AE, TAE and AF45 ... AF75 4-pole contactors

Technical data

Main pole - Utilization characteristics according to IEC

Contactor types	AC operated	A45	A50	A75
	DC operated	AE45	AE50	AE75
		TAE45	TAE50	TAE75
	AC / DC operated	AF45	AF50	AF75
Standards	IEC 60947-1 / 60947-4-1 and EN 60947-1 / 60947-4-1			
Rated operational voltage U _e max.	1000 V (690 V for AF.. contactors)			
Rated frequency (without derating)	50 / 60 Hz			
Conventional free-air thermal current I _{th}				
acc. to IEC 60947-4-1, open contactors, $\theta \leq 40^\circ\text{C}$	100 A	100 A	125 A	
With conductor cross-sectional area	35 mm ²	35 mm ²	50 mm ²	
AC-1 Utilization category				
For air temperature close to contactor				
I _e / Rated operational current AC-1	$\theta \leq 40^\circ\text{C}$	70 A	100 A	125 A
U _e max. $\leq 690\text{ V}$, 50/60 Hz	$\theta \leq 55^\circ\text{C}$	60 A	85 A	105 A
	$\theta \leq 70^\circ\text{C}$ (1)	50 A	70 A	85 A
With conductor cross-sectional area		25 mm ²	35 mm ²	50 mm ²
Short-circuit protection device for contactors				
without thermal overload relay - Motor protection excluded				
U _e $\leq 500\text{ V AC}$ - gG type fuse	80 A	100 A	160 A	
Rated short-time withstand current I _{cw}	1 s	1000 A		
At 40 °C ambient temperature,	10 s	650 A		
in free air from a cold state	30 s	370 A		
	1 min	250 A		
	15 min	110 A	110 A	135 A
Power dissipation per pole	I _e / AC-1	2.5 W	5 W	7 W
Max. electrical switching frequency	AC-1	600 cycles/h (300 for AF.., AE.., TAE..)		

(1) Unauthorized for TAE.. contactors

Main pole - Utilization characteristics according to UL / CSA

Contactor types	AC operated	A45	A50	A75
	DC operated	AE45	AE50	AE75
		TAE45	TAE50	TAE75
	AC / DC operated	AF45	AF50	AF75
Standards	UL 508, CSA C22.2 N°14			
Max. operational voltage	600 V			
UL / CSA general use rating				
600 V AC	65 A	80 A	105 A	
With conductor cross-sectional area	AWG 6	AWG 4	AWG 2	
Max. electrical switching frequency				
For general use	600 cycles/h (300 for AF.., AE.., TAE..)			

Remark for 4-pole contactors fitted with 2 N.O. + 2 N.C. main poles

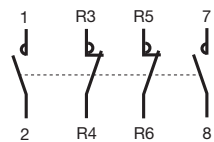

These contactors are suitable for controlling 2 separate circuits, i.e. 2 loads with 2 separate supplies, or 1 circuit comprising 2 separate loads with a single supply (see diagrams below). When the contactor operates there is no mechanical overlapping between the N.O. poles and the N.C. poles: BREAK before MAKE.



These contactors are not suitable for a reversing starter or for controlling a single load from 2 separate supplies.

Block diagrams

- Single supply and 2 separate loads

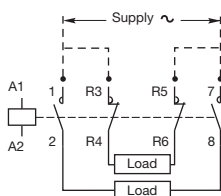

- 2 separate supplies and 2 separate loads

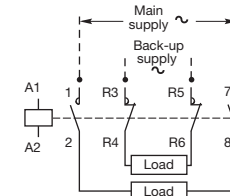

EK110 ... EK1000 4-pole contactors

Technical data

Main pole - Utilization characteristics according to IEC

Contactor types	AC or DC operated	EK110	EK150	EK175	EK210	EK370	EK550	EK1000
Standards		IEC 60947-1 / 60947-4-1 and EN 60947-1 / 60947-4-1						
Rated operational voltage U _e max.		1000 V						
Rated frequency (without derating)		50 / 60 Hz						
Conventional free-air thermal current I _{th}								
acc. to IEC 60947-4-1, open contactors, $\theta \leq 40^\circ\text{C}$		200 A	250 A	300 A	350 A	550 A	800 A	1000 A
With conductor cross-sectional area		95 mm ²	150 mm ²	185 mm ²	240 mm ²	2x 185 mm ²	2x 240 mm ²	2x 300 mm ²
AC-1 Utilization category								
For air temperature close to contactor								
I_e / Rated operational current AC-1	$\theta \leq 40^\circ\text{C}$	200 A	250 A	300 A	350 A	550 A	800 A	1000 A
U _e max. $\leq 1000\text{ V}$, 50/60 Hz	$\theta \leq 55^\circ\text{C}$	180 A	230 A	270 A	310 A	470 A	650 A	800 A
	$\theta \leq 70^\circ\text{C}$	155 A	200 A	215 A	250 A	400 A	575 A	720 A
With conductor cross-sectional area		95 mm ²	150 mm ²	185 mm ²	240 mm ²	2x 185 mm ²	2x 240 mm ²	2x 300 mm ²
AC-3 Utilization category								
For air temperature close to contactor $\theta \leq 55^\circ\text{C}$								
I_e / Max. rated operational current AC-3 (1)								
	220-230-240 V	120 A	145 A	210 A	210 A	400 A	550 A	-
	380-400 V	120 A	145 A	210 A	210 A	400 A	550 A	-
	415 V	120 A	145 A	210 A	210 A	400 A	550 A	-
	440 V	120 A	145 A	210 A	210 A	370 A	550 A	-
	500 V	120 A	145 A	210 A	210 A	370 A	550 A	-
	690 V	120 A	120 A	210 A	210 A	370 A	550 A	-
	1000 V	64 A	80 A	113 A	113 A	155 A	175 A	-
Rated operational power AC-3 (1)								
	220-230-240 V	30 kW	45 kW	59 kW	59 kW	110 kW	160 kW	-
	380-400 V	55 kW	75 kW	110 kW	110 kW	200 kW	280 kW	-
	415 V	55 kW	75 kW	110 kW	110 kW	220 kW	315 kW	-
	440 V	59 kW	75 kW	110 kW	110 kW	220 kW	315 kW	-
	500 V	75 kW	90 kW	132 kW	132 kW	250 kW	400 kW	-
	690 V	110 kW	110 kW	160 kW	160 kW	355 kW	500 kW	-
	1000 V	90 kW	110 kW	160 kW	160 kW	220 kW	250 A	-
Rated making capacity AC-3		10 x I _e AC-3 acc. to IEC 60947-4-1						
Rated breaking capacity AC-3		8 x I _e AC-3 acc. to IEC 60947-4-1						
Short-circuit protection device for contactors								
without thermal overload relay - Motor protection excluded								
U _e $\leq 500\text{ V AC}$ - gG type fuse		250 A	250 A	355 A	355 A	630 A	800 A	1000 A
Rated short-time withstand current I_{cw}								
at 40 °C ambient temperature,	1 s	1700 A	1800 A	2300 A	2300 A	5500 A	5500 A	6800 A
in free air from a cold state	10 s	900 A	1200 A	1680 A	1680 A	5300 A	5300 A	6400 A
	30 s	600 A	700 A	1000 A	1000 A	3700 A	3700 A	4400 A
	1 min	450 A	550 A	800 A	800 A	3000 A	3000 A	3400 A
	15 min	210 A	250 A	320 A	320 A	1000 A	1000 A	1200 A
Maximum breaking capacity								
cos $\phi = 0.45$	at 440 V	1400 A	1500 A	2000 A	2000 A	5000 A	5400 A	-
(cos $\phi = 0.35$ for I _e > 100 A)	at 690 V	1100 A	1200 A	1700 A	1700 A	5000 A	5400 A	-
Power dissipation per pole								
	I _e / AC-1	10 W	13 W	18 W	18 W	40 W	60 W	80 W
	I _e / AC-3	3 W	5 W	9 W	9 W	15 W	25 W	-
Max. electrical switching frequency								
	AC-1	300 cycles/h						
	AC-3	300 cycles/h						
	AC-2, AC-4	150 cycles/h		120 cycles/h				



3-phase motors



1500 r.p.m. 50 Hz
1800 r.p.m. 60 Hz
3-phase motors

Main pole - Utilization characteristics according to UL / CSA

Contactor types	AC or DC operated	EK110	EK150	EK175	EK210	EK370	EK550	EK1000
Standards		UL 508, CSA C22.2 N°14						
Max. operational voltage		600 V						
UL / CSA general use rating								
600 V AC		170 A	200 A	250 A	300 A	420 A	540 A	-
Short-circuit protection device for contactors								
without thermal overload relay - Motor protection excluded								
Fuse rating		400 A				1200 A		
Fuse type, 600 V		J				L		
Max. electrical switching frequency		300 cycles/h						
For general use		300 cycles/h						

(1) For the corresponding kW/A or hp/A values of 1500 r.p.m., 50 Hz or 1800 r.p.m., 60 Hz, 3-phase motors, see "Motor rated operational powers and currents".

AF09 ... AF38 4-pole contactors

Technical data

Magnet system characteristics

Contactor types		AC / DC operated	AF09	AF16	AF26	AF38
Coil operating limits acc. to IEC 60947-4-1		AC supply	At $\theta \leq 60\text{ °C}$ $0.85 \times U_c \text{ min...} 1.1 \times U_c \text{ max.}$ At $\theta \leq 70\text{ °C}$ $0.85 \times U_c \text{ min...} U_c \text{ max.}$			
		DC supply	At $\theta \leq 60\text{ °C}$ $0.85 \times U_c \text{ min...} 1.1 \times U_c \text{ max.}$ At $\theta \leq 70\text{ °C}$ (AF) $0.85 \times U_c \text{ min...} U_c \text{ max.}$ - (AF..Z) $0.85 \times U_c \text{ min...} 1.1 \times U_c \text{ max.}$			
AC control voltage 50/60 Hz	Rated control circuit voltage U_c		24...500 V AC			
	Coil consumption	Average pull-in value	(AF) 50 VA - (AF..Z) 16 VA			
		Average holding value	(AF) 2.2 VA / 2 W - (AF..Z) 1.7 VA / 1.5 W			
DC control voltage	Rated control circuit voltage U_c		12...500 V DC			
	Coil consumption	Average pull-in value	(AF) 50 W - (AF..Z) 12...16 W			
		Average holding value	(AF) 2 W - (AF..Z) 1.7 W			
PLC-output control			(AF..Z) $\geq 500\text{ mA}$ 24 V DC			
Drop-out voltage			$\leq 60\%$ of $U_c \text{ min.}$			
Voltage sag immunity	acc. to SEMI F47-0706		(AF..Z) conditions of use on request			
Dips withstand $-20\text{ °C} \leq \theta \leq +60\text{ °C}$			(AF..Z) 22 ms average			
Operating time						
	Between coil energization and:	N.O. contact closing	40...95 ms			
		N.C. contact opening	38...90 ms			
	Between coil de-energization and:	N.O. contact opening	11...95 ms			
		N.C. contact closing	13...98 ms			

5

Mounting characteristics and conditions for use

Contactor types		AF09	AF16	AF26	AF38
Mounting positions					
Mounting distances		Max. add-on N.C. auxiliary contacts: see accessory fitting details for a 4-pole contactor AF09 ... AF38			
Fixing	On rail according to IEC 60715, EN 60715	The contactors can be assembled side by side			
	By screws (not supplied)	35 x 7.5 mm or 35 x 15 mm 2 x M4 screws placed diagonally			

A45 ... A75 4-pole contactors

Technical data

Magnet system characteristics

Contactor types		AC operated	A45	A50	A75
Coil operating limits acc. to IEC 60947-4-1		AC supply	At $\theta \leq 55^\circ\text{C}$ 0.85...1.1 x U_c		
AC control voltage		Rated control circuit voltage U_c	Please also refer to "Mounting characteristics and conditions for use"		
		at 50 Hz	24...690 V		
		at 60 Hz	24...690 V		
Coil consumption		Average pull-in value	50 Hz	180 VA	
			60 Hz	210 VA	
			50/60 Hz (1)	190 VA / 180 VA	
		Average holding value	50 Hz	18 VA / 5.5 W	
			60 Hz	18 VA / 5.5 W	
			50/60 Hz (1)	18 VA / 5.5 W	
Drop-out voltage			approx. 40...65 % of U_c		
Operating time					
Between coil energization and:		N.O. contact closing	8...27 ms		
		N.C. contact opening	7...22 ms		
Between coil de-energization and:		N.O. contact opening	4...11 ms		
		N.C. contact closing	7...14 ms		

(1) 50/60 Hz coils: see "Coil voltage code table".

Mounting characteristics and conditions for use

Contactor types		AC operated	A45	A50	A75
Mounting positions					
			Pos. 5 unauthorized for A45-22-00, A75-22-00		
			Max. add-on N.O. or N.C. auxiliary contacts: see accessory fitting details for 4-pole contactor A45 ... A75		
Control voltage / Ambient temperature					
Mounting positions (1)		at $\theta \leq 55^\circ\text{C}$	0.85...1.1 x U_c		
		at $\theta \leq 70^\circ\text{C}$	U_c		
6		at $\theta \leq 55^\circ\text{C}$	0.95...1.1 x U_c		
		at $\theta \leq 70^\circ\text{C}$	Unauthorized		
Mounting distances			The contactors can be assembled side by side		
Fixing		On rail according to IEC 60715, EN 60715	35 x 15 mm or 75 x 25 mm		
		By screws (not supplied)	2 x M6 screws placed diagonally		

(1) For 60 Hz coil voltage: (only for devices fitted with CA 5-... and CAL 5-11 auxiliary contacts or TP timer).

– A45-40-00, A50-40-00 and A75-40-00 contactors.

Mounting positions 1 to 5 and ambient temperature $\leq 55^\circ\text{C}$: tolerance reduced to 0.9...1.1 U_c (instead of 0.85...1.1 U_c) for coil voltage codes 70 to 79 and 80 to 89.

– A45-22-00 and A75-22-00 contactors.

Mounting positions 1 to 4 and ambient temperature $\leq 55^\circ\text{C}$: tolerance reduced to 0.9...1.1 U_c (instead of 0.85...1.1 U_c) for coil voltage codes 70 to 79 and 80 to 89.

For mounting position 6 or ambient temperature of 55 to 70 $^\circ\text{C}$ the information given on this page remains applicable.

AE45 ... AE75 4-pole contactors

Technical data

Magnet system characteristics

Contactor types		DC operated	AE45	AE50	AE75
Coil operating limits		DC supply	At $\theta \leq 55^\circ\text{C}$ $0.85 \dots 1.1 \times U_c$		
acc. to IEC 60947-4-1			Please also refer to "Mounting characteristics and conditions for use"		
DC control voltage	Rated control circuit voltage U_c		12...250 V DC		
	Coil consumption	Average pull-in value	200 W		
		Average holding value	4 W		
Drop-out voltage			approx. 15...40 % of U_c		
Coil time constant	Open	L/R	3 ms		
	Closed	L/R	15 ms		
Operating time					
Between coil energization and:		N.O. contact closing	13...30 ms		
		N.C. contact opening	10...27 ms		
Between coil de-energization and:		N.O. contact opening (1)	5...15 ms		
		N.C. contact closing (1)	8...18 ms		

(1) The use of surge suppressors increases the opening time with a factor of 1.1 to 1.5 for RV5 surge suppressor and a factor of 1.5 to 3 for RT5 surge suppressor.

5

Mounting characteristics and conditions for use

Contactor types		DC operated	AE45	AE50	AE75
Mounting positions					
			Pos. 5 unauthorized for AE45-22-00, AE75-22-00		
			Max. add-on N.O. or N.C. auxiliary contacts: see accessory fitting details for 4-pole contactor AE45 ... AE75 (1)(2)		
Control voltage / Ambient temperature					
Mounting positions	1, 1±30°, 2, 3, 4, 5	at $\theta \leq 55^\circ\text{C}$	0.85...1.1 x U_c		
		at $\theta \leq 70^\circ\text{C}$	U_c		
	6	at $\theta \leq 55^\circ\text{C}$	0.95...1.1 x U_c		
		at $\theta \leq 70^\circ\text{C}$	Unauthorized		
Mounting distances			The contactors can be assembled side by side		
Fixing	On rail according to IEC 60715, EN 60715		35 x 15 mm or 75 x 25 mm		
	By screws (not supplied)		2 x M6 screws placed diagonally		

AF45 ... AF75 4-pole contactors

Technical data

Magnet system characteristics

Contactor types		AC / DC operated	AF45	AF50	AF75
Coil operating limits		AC or DC supply	At $\theta \leq 70^\circ\text{C}$ $0.85 \times U_c \text{ min...} 1.1 \times U_c \text{ max.}$		
acc. to IEC 60947-4-1			Please also refer to "Mounting characteristics and conditions for use"		
AC control voltage 50/60 Hz	Rated control circuit voltage U_c		48...250 V		
	Coil consumption	Average pull-in value	210 VA		
		Average holding value	7 VA / 2.8 W		
DC control voltage	Rated control circuit voltage U_c		20...250 V DC		
	Coil consumption	Average pull-in value	190 W		
		Average holding value	2.8 W		
Drop-out voltage			55 % of $U_c \text{ min.}$		
Voltage sag immunity			Conditions of use on request		
acc. to SEMI F47					
Dips withstand			$\geq 20 \text{ ms}$		
Operating time					
Between coil energization and:	N.O. contact closing		30...100 ms		
	N.C. contact opening		27...95 ms		
Between coil de-energization and:	N.O. contact opening		30...110 ms		
	N.C. contact closing		35...115 ms		

Mounting characteristics and conditions for use

Contactor types		AC / DC operated	AF45	AF50	AF75
Mounting positions					
			Pos. 5 unauthorized for AF45-22-00, AF75-22-00 contactors		
			Max. and add-on N.O. or N.C. auxiliary contacts: see accessory fitting details for 4-pole contactor AF45 ... AF110		
Control voltage / Ambient temperature					
Mounting positions	1, 1±30°, 2, 3, 4, 5	at $\theta \leq 70^\circ\text{C}$	$0.85 \times U_c \text{ min...} 1.1 \times U_c \text{ max.}$		
	6		Unauthorized		
Mounting distances			The contactors can be assembled side by side		
Fixing	On rail according to IEC 60715, EN 60715		35 x 15 mm or 75 x 25 mm		
	By screws (not supplied)		2 x M6 screws placed diagonally		

EK110 ... EK1000 4-pole contactors

Technical data

Magnet system characteristics

Contactor types		AC operated	EK110	EK150	EK175	EK210	EK370	EK550	EK1000	
Coil operating limits		AC supply	At $\theta \leq 70^\circ\text{C}$ $0.85 \times U_c \text{ min} \dots 1.1 \times U_c \text{ max}$. Please also refer to "Mounting characteristics and conditions for use"							
acc. to IEC 60947-4-1										
AC control voltage	Rated control circuit voltage	50 Hz	24...500 V				48...500 V			
		60 Hz	24...600 V				110...600 V			
	Coil consumption	Average pull-in value	50 Hz	800 VA		1100 VA		3500 VA		
			60 Hz	900 VA		1200 VA		4000 VA		
		50/60 Hz (1)	500 / 500 VA		630 / 630 VA		3800 / 3400 VA			
	Average holding value	50 Hz	44 VA / 15 W		52 VA / 18 W		125 VA / 50 W			
		60 Hz	52 VA / 18 W		65 VA / 22 W		140 VA / 60 W			
50/60 Hz (1)		2.5 VA / 2.5 W		2.5 VA / 2.5 W		140 VA / 60 W				
Drop-out voltage in % of $U_c \text{ min}$.			approx. 45...65 % (20...50 % for "E" coil voltage codes)						approx. 45...65 %	
Operating time										
Between coil energization and:		N.O. contact closing	20...40 (1) / 30...50 (2) ms				30...60 ms			
		N.C. contact opening	15...35 (1) / 25...45 (2) ms				25...55 ms			
Between coil de-energization and:		N.O. contact opening	7.5...15 (1) / 9.5...120 (2) ms				10...20 ms			
		N.C. contact closing	10...18 (1) / 100...125 (2) ms				13...23 ms			

(1) "A" coil voltage: see "Coil voltage code table".

(2) 50/60 Hz "E" coil voltage codes, see "Coil voltage code table".

Magnet system characteristics

Contactor types		DC operated	EK110	EK150	EK175	EK210	EK370	EK550	EK1000		
Coil operating limits		DC supply	At $\theta \leq 70^\circ\text{C}$ $0.85 \times U_c \text{ min} \dots 1.1 \times U_c \text{ max}$. Please also refer to "Mounting characteristics and conditions for use"								
acc. to IEC 60947-4-1											
DC control voltage	Rated control circuit voltage		12...220						24...220		
	Coil consumption	Average pull-in value	500 W				630 W		1100 W		
		Average holding value	2.5 W				2.5 W		20 W		
Drop-out voltage			approx. 15...50 % of $U_c \text{ min}$.								
Coil time constant	Open	L/R	8 ms				12 ms				
	Closed	L/R	50 ms				60 ms				
Operating time											
Between coil energization and:		N.O. contact closing	30...50 ms				60...80 ms				
		N.C. contact opening	27...47 ms				55...75 ms				
Between coil de-energization and:		N.O. contact opening	10...35 ms								
		N.C. contact closing	13...38 ms								

Mounting characteristics and conditions for use

Contactor types		AC / DC operated	EK110	EK150	EK175	EK210	EK370	EK550	EK1000	
Mounting positions										
Control voltage / Ambient temperature			Max. N.O. or N.C. built-in and add-on N.O. or N.C. auxiliary contacts: see accessory fitting details for 4-pole contactor EK110 ... EK1000							
Mounting positions	1, $1 \pm 30^\circ$, 2, 3, 4, 5	at $\theta \leq 70^\circ\text{C}$	0.85...1.1 x U_c							
	2	at $\theta \leq 70^\circ\text{C}$	Unauthorized						0.85...1.1 x U_c	
	6	at $\theta \leq 70^\circ\text{C}$	Unauthorized							
Mounting distances			The contactors can be assembled side by side							
Fixing	On rail according to IEC 60715, EN 60715		-							
	By screws (supplied)		4 x M6				4 x M6 (1)			

(1) Damping elements are supplied.

AF09 ... AF38 4-pole contactors

Technical data

General technical data

Contactor types	AF09	AF16	AF26	AF38
Rated insulation voltage Ui				
acc. to IEC 60947-4-1	690 V			
acc. to UL / CSA	600 V			
Rated impulse withstand voltage Uimp.	6 kV			
Electromagnetic compatibility	Devices complying with IEC 60947-1 / EN 60947-1 - Environment A			
Ambient air temperature close to contactor				
Operation	-40...+70 °C			
Storage	-60...+80 °C			
Climatic withstand	Category B according to IEC 60947-1 Annex Q			
Maximum operating altitude (without derating)	3000 m			
Mechanical durability				
Number of operating cycles	10 millions operating cycles			
Max. switching frequency	3600 cycles/h			
Shock withstand				
acc. to IEC 60068-2-27 and EN 60068-2-27				
Mounting position 1				
	Shock direction	1/2 sinusoidal shock for 11 ms: no change in contact position, closed or open position		
	A	30 g		
	B1	25 g closed position / 5 g open position		
	B2	15 g		
	C1	25 g		
	C2	25 g		
	A	30 g	30 g closed position / 25 g open position	
	B1	25 g closed position / 5 g open position	25 g closed position / 5 g open position	
	B2	15 g	15 g closed position / 10 g open position	
	C1	25 g	25 g closed position / 20 g open position	
	C2	25 g	25 g closed position / 20 g open position	
Vibration withstand				
acc. to IEC 60068-2-6	5...300 Hz			
	4 g closed position / 2 g open position			

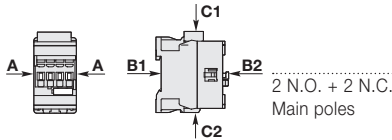

A45 ... A75, AE, TAE and AF45 ... AF75 4-pole contactors

Technical data

General technical data

Contactor types	AC operated	A45	A50	A75
	DC operated	AE45	AE50	AE75
		TAE45	TAE50	TAE75
	AC / DC operated	AF45	AF50	AF75
Rated insulation voltage Ui				
acc. to IEC 60947-4-1		1000 V		
acc. to UL / CSA		600 V		
Rated impulse withstand voltage Uimp.		8 kV		
Electromagnetic compatibility		AF contactors complying with IEC 60947-1 / EN 60947-1 - Environment A		
Ambient air temperature close to contactor				
Operation		-40...+70 °C (1)		
Storage		-60...+80 °C		
Climatic withstand		acc. to IEC 60068-2-30 and 60068-2-11 - UTE C 63-100 specification II		
Maximum operating altitude (without derating)		3000 m		
Mechanical durability				
Number of operating cycles		10 millions operating cycles (5 millions for AE... and TAE... contactors)		
Max. switching frequency		3600 cycles/h (300 for AF..)		
Shock withstand				
acc. to IEC 60068-2-27 and EN 60068-2-27				
Mounting position 1				
Shock direction		1/2 sinusoidal shock for 11 ms: no change in contact position, closed or open position		
<p>4 N.O. Main poles</p> <p>2 N.O. + 2 N.C. Main poles</p>		A	20 g	
		B1	10 g closed position / 5 g open position	
		B2	15 g	
		C1	20 g	
		C2	20 g	
		A	20 g	
		B1	10 g closed position / 5 g open position (2)	
		B2	15 g (3)	
		C1	20 g	
		C2	20 g	

(1) 55 °C max. for TAE... contactors.

(2) 3 g in open position for AF 45-22, AE 45-22, AF 75-22 and AE 75-22.

(3) 10 g for AF 45-22, AE 45-22, AF 75-22 and AE 75-22.

EK110 ... EK1000 4-pole contactors

Technical data

General technical data

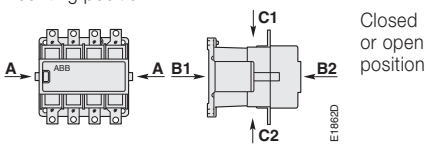









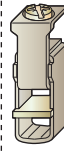



Contactor types	AC or DC operated	EK110	EK150	EK175	EK210	EK370	EK550	EK1000
Rated insulation voltage U_i								
acc. to IEC 60947-4-1		1000 V						
acc. to UL		600 V						
Rated impulse withstand voltage U_{imp}		8 kV						
Electromagnetic compatibility		EK contactors complying with IEC 60947-1 / EN 60947-1 - Environment A						
Ambient air temperature close to contactor								
Operation	Fitted with thermal overload relay	-25 to +55 °C					-	
	Without thermal overload relay	-40 to +70 °C					-	
Storage		-50 to +70 °C					-	
Climatic withstand		Category B acc. to IEC 60068-2-30						
Maximum operating altitude (without derating)		≤ 3000 m						
Mechanical durability								
Number of operating cycles		10 millions operating cycles			5 millions operating cycles		3 millions operating cycles	
Max. switching frequency		3600 cycles/h			60 cycles/h			
Shock withstand								
acc. to IEC 60068-2-27 and EN 60068-2-27								
Mounting position 1								
								
	Shock direction	1/2 sinusoidal shock for 15 ms: no change in contact position, closed or open position						
	A	10 g						
	B1	10 g						
	B2	10 g						
	C1	10 g						
	C2	10 g						

5

AF09 ... AF38 4-pole contactors

Technical data







Connecting characteristics

Contactor types	AF09	AF16	AF26	AF38
Main terminals	 Screw terminals with cable clamp		 Screw terminals with double connector 2 x (5.5 width x 6.8 depth)	
Connection capacity (min. ... max.)				
Main conductors (poles)				
 Rigid	Solid ($\leq 4 \text{ mm}^2$)		1.5...16 mm ²	
 Stranded ($\geq 6 \text{ mm}^2$)	1 x		1.5...16 mm ²	
 Flexible with non insulated ferrule	2 x		1.5...16 mm ²	
 Flexible with insulated ferrule	1 x		1.5...16 mm ²	
 Flexible with insulated ferrule	2 x		1.5...16 mm ²	
 Bars or lugs	L <		9.6 mm	
Connection capacity acc. to UL/CSA	1 or 2 x		AWG 16...10	
Stripping length			10 mm	
Tightening torque			1.5 Nm / 13 lb.in	
Auxiliary conductors (coil terminals)				
 Rigid solid	1 x		1...2.5 mm ²	
 Flexible with non insulated ferrule	2 x		1...2.5 mm ²	
 Flexible with insulated ferrule	1 x		0.75...2.5 mm ²	
 Flexible with insulated ferrule	2 x		0.75...2.5 mm ²	
 Flexible with insulated ferrule	1 x		0.75...2.5 mm ²	
 Flexible with insulated ferrule	2 x		0.75...1.5 mm ²	
 Lugs	L <		8 mm	
Connection capacity acc. to UL/CSA	1 or 2 x		AWG 18...14	
Stripping length			10 mm	
Tightening torque			1.2 Nm / 11 lb.in	
Degree of protection acc. to IEC 60947-1 / EN 60947-1 and IEC 60529 / EN 60529				
Main terminals	IP20			
Coil terminals	IP20			
Screw terminals	Delivered in open position, screws of unused terminals must be tightened			
Main terminals			M3.5	
	Screwdriver type		Flat Ø 5.5 / Pozidriv 2	
Coil terminals			M3.5	
	Screwdriver type		Flat Ø 5.5 / Pozidriv 2	

A45 ... A75, AE, TAE and AF45 ... AF75 4-pole contactors

Technical data

Connecting characteristics

Contactor types	AC operated	A45	A50	A75
	DC operated	AE45	AE50	AE75
		TAE45	TAE50	TAE75
	AC / DC operated	AF45	AF50	AF75
Main terminals	 Screw terminals with single connector (13 x 10 mm)			
Connection capacity (min. ... max.)				
Main conductors (poles)				
	Rigid	Solid ($\leq 4 \text{ mm}^2$)	} 1 x	6...50 mm ²
		Stranded ($\geq 6 \text{ mm}^2$)		2 x
	Flexible with ferrule		1 x	6...35 mm ²
			2 x	6...16 mm ²
	Bars or lugs		L \leq	-
			L $>$	-
Connection capacity acc. to UL/CSA			1 or 2 x	AWG 8...1
Tightening torque		Recommended	4.00 Nm / 35 lb.in	
		Max.	4.50 Nm	
Auxiliary conductors (built-in auxiliary terminals + coil terminals)				
	Rigid solid		1 x	1...4 mm ²
			2 x	1...4 mm ²
	Flexible with ferrule		1 x	1...2.5 mm ²
			2 x	0.75...2.5 mm ²
	Lugs		L \leq	8 mm
			L $>$	3.7 mm
Connection capacity acc. to UL/CSA			1 or 2 x	AWG 18...14
Tightening torque		Recommended	1.00 Nm / 9 lb.in	
		Max.	1.20 Nm	
Degree of protection acc. to IEC 60947-1 / EN 60947-1 and IEC 60529 / EN 60529				
Main terminals			IP10	
Coil terminals			IP20	
Screw terminals Delivered in open position, screws of unused terminals must be tightened				
Main terminals			M6	
			Screwdriver type	Flat \varnothing 6.5 / Pozidriv 2
Coil terminals			M3.5	
			Screwdriver type	Flat \varnothing 5.5 / Pozidriv 2

EK110 ... EK1000 4-pole contactors

Technical data

Connecting characteristics

Contactors types		AC or DC operated	EK110	EK150	EK175	EK210	EK370	EK550	EK1000
Main terminals									
Flat type									
Connection capacity (min. ... max.)									
Main conductors (poles)									
	Rigid with connector	Single for Cu cable	25...120 mm ²	25...185 mm ²	25...185 mm ²	70...300 mm ²	-	-	-
		Single for Al/Cu cable	10...70 mm ²	35...120 mm ²	35...120 mm ²	70...300 mm ²	95...300 mm ²	2 x 95...300	2 x 95...300
		Double for Al/Cu cable	-	-	-	2 x 35...185	-	-	-
	Bars or lugs		L ≤ 30 mm Ø > 6 mm	30 mm 10 mm	33 mm 10 mm	33 mm 10 mm	55 mm 10 mm	55 mm 10 mm	55 mm 10 mm
Connection capacity acc. to UL/CSA		1 or 2 x	8 - 3/0 AWG	-	6 - 250 MCM	2 x 4 - 500 MCM	3 x 4 - 500 MCM	-	-
Tightening torque		Recommended	5 Nm/44 lb.in	18 Nm / 160 lb.in	-	-	-	-	-
		Max.	6 Nm	22 Nm	-	-	-	-	-
Auxiliary conductors (coil terminals)									
	Rigid solid	1 x	0.5...2.5 mm ²	-	-	-	-	-	-
		2 x	0.5...2.5 mm ²	-	-	-	-	-	-
	Flexible with ferrule	1 x	0.5...2.5 mm ²	-	-	-	-	-	-
		2 x	0.5...2.5 mm ²	-	-	-	-	-	-
	Bars or lugs	L ≤ 8 mm l > 3.7 mm	-	-	-	-	-	-	-
Connection capacity acc. to UL/CSA		1 or 2 x	18...14 AWG	-	-	-	-	-	-
Tightening torque		Recommended	1.00 Nm / 9 lb.in	-	-	-	-	-	-
		Max.	1.20 Nm	-	-	-	-	-	-
Degree of protection									
acc. to IEC 60947-1 / EN 60947-1 and IEC 60529 / EN 60529									
Main terminals			IP00	-	-	-	-	-	-
Coil terminals			IP20	-	-	-	-	-	-
Screw terminals									
Main terminals			M6	-	M10	-	-	-	-
			Screws and bolts		-	-	-	-	-
Coil terminals (delivered in open positions)			M3.5	-	-	-	-	-	-
Screwdriver type			Flat Ø 5.5 mm / Pozidriv 2		-	-	-	-	-

4-pole contactors

Electrical durability and utilization categories

General

Utilization categories determine the current making and breaking conditions relating to the characteristics of the loads to be controlled by the contactors. International standard IEC 60947-4-1 and European standard EN 60947-4-1 are the standards to be referred to. If I_c is the current to be broken by the contactor and I_e the rated operational current normally drawn by the load, then $I_c = I_e$ for category AC-1. The curve corresponding to category AC-1 represents the electrical durability variation of standard contactors in relation to the breaking current I_c .

Electrical durability is expressed in millions of operating cycles.

Curve utilization mode

Electrical durability forecast and contactor selection for category AC-1

- Note the characteristics of the load to be controlled:
 - Operational voltage U_e
 - Current normally drawn I_e
 - Utilization category AC-1
 - Breaking current $I_c = I_e$ for AC-1
- Define the number of operating cycles N required.
- On the diagram corresponding to the operational category, select the contactor with the curve immediately above the intersection point ($I_c ; N$).

Case of uninterrupted duty

For uninterrupted duty, some verifications of preventing maintenance are necessary to check the functionality of the concerned product (consult us). The combined effect of environmental conditions and the proper temperature of the product may require some disposals. As a matter of fact, for this duty, the use duration prevails over the number of operating cycles.

4-pole contactors

Electrical durability

Electrical durability for AC-1 utilization category - $U_e \leq 690\text{ V}$

Ambient temperature $\leq 60\text{ }^\circ\text{C}$ for AF09 ... AF38, $\leq 55\text{ }^\circ\text{C}$ for A45 ... EK1000

Switching non-inductive or slightly inductive loads. The breaking current I_c for AC-1 is equal to the rated operational current of the load.

Maximum electrical switching frequency: see "Technical data".

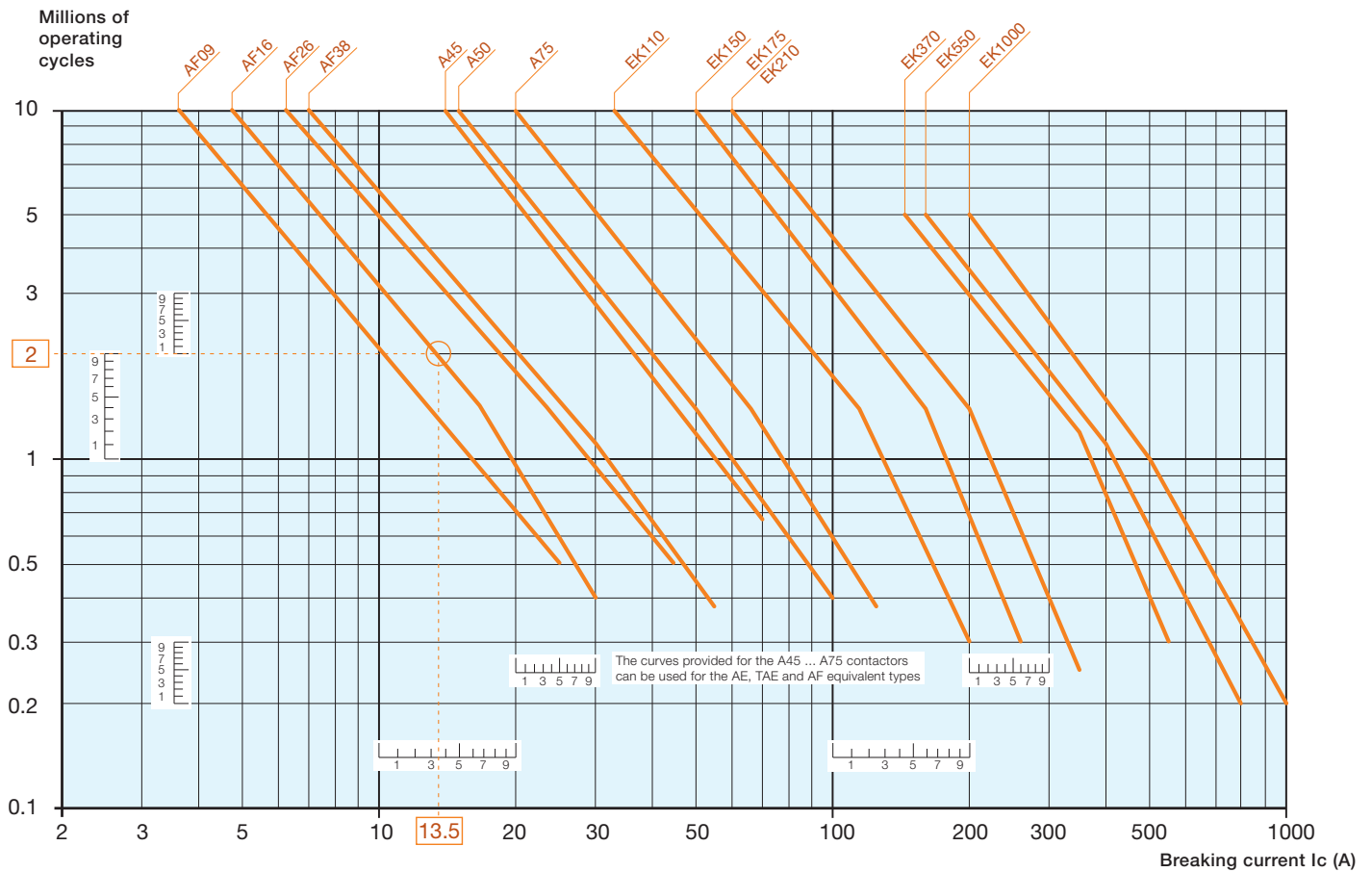

Example:

$I_c / \text{AC-1} = 13.5\text{ A}$ – Electrical durability required = 2 millions operating cycles.

Using the AC-1 curves above select the AF16 contactor at intersection "○" (13.5 A / 2 millions operating cycles).



Contactors for capacitor switching

[Overview](#) 5/94

UA16..RA up to UA110..RA - Unlimited peak \hat{I}

Ordering details	5/96
Technical data	5/99

UA16 up to UA110 - Peak current $\hat{I} \leq 100$ times the rms current

Ordering details	5/101
Technical data	5/104

Contactors for capacitor switching

AC-6b utilization category according to IEC 60947-4-1

Capacitor transient conditions

In Low Voltage industrial installations, capacitors are mainly used for reactive energy correction (raising the power factor). When these capacitors are energized, overcurrents of high amplitude and high frequencies (3 to 15 kHz) occur during the transient period (1 to 2 ms).

The amplitude of these current peaks, also known as "inrush current peaks", depends on the following factors:

- The network inductances.
- The transformer power and short-circuit voltage.
- The type of power factor correction.

There are 2 types of power factor correction: fixed or automatic.

Fixed power factor correction consists of inserting, in parallel on the network, a capacitor bank whose total power is provided by the assembly of capacitors of identical or different ratings.

The bank is energized by a contactor that simultaneously supplies all the capacitors (a single step).

The inrush current peak, in the case of fixed correction, can reach 30 times the nominal current of the capacitor bank.



Single-step capacitor bank scheme
Use the A/AF... contactor ranges.

An automatic power factor correction system, on the other hand, consists of several capacitor banks of identical or different ratings (several steps), energized separately according to the value of the power factor to be corrected.

An electronic device automatically determines the power of the steps to be energized and activates the relevant contactors.

The inrush current peak, in the case of automatic correction, depends on the power of the steps already on duty, and can reach 100 times the nominal current of the step to be energized.

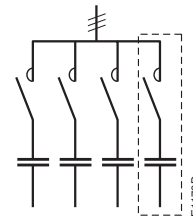

Multi-step capacitor bank scheme
Use the UA... or UA..RA contactor ranges.

Steady state condition data

The presence of harmonics and the network's voltage tolerance lead to a current, estimated to be 1.3 times the nominal current I_n of the capacitor, permanently circulating in the circuit.

Taking into account the manufacturing tolerances, the exact power of a capacitor can reach 1.15 times its nominal power.

Standard IEC 60831-1 Edition 2002 specifies that the capacitor must therefore have a maximum thermal current I_T of:

$$I_T = 1.3 \times 1.15 \times I_n = 1.5 \times I_n$$

Consequences for the contactors

To avoid malfunctions (welding of main poles, abnormal temperature rise, etc.), contactors for capacitor bank switching must be sized to withstand:

- A permanent current that can reach 1.5 times the nominal current of the capacitor bank.
- The short but high peak current on pole closing (maximum permissible peak current \hat{I}).

Contactor selection tool for capacitor switching

In a given application, if the user does not know the value of the inrush current peak, this value can be approximately calculated using the formulas given on the pages "Calculation and dimensioning".

Alternatively by the **CAPCAL selection tool**, available on the ABB Website:

www.abb.com/lowvoltage

right hand side menu

search: "Online product selection tools"

select: "Contactors: AC-6b capacitor switching"

This program allows the calculation of these peaks and gives the references of the ABB contactors according to the installation specifications. This calculation is valid for one or several capacitor banks.

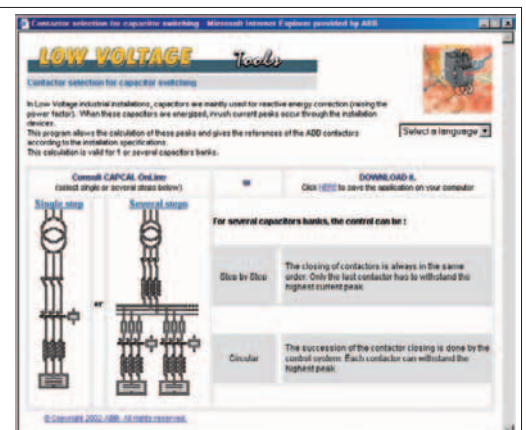

Contactors for capacitor switching

The ABB solutions

ABB offers 3 contactor versions according to the value of the inrush current peak and the power of the capacitor bank.

UA..RA contactors for capacitor switching (UA16..RA to UA110..RA) with insertion of damping resistors.

The insertion of damping resistors protects the contactor and the capacitor from the highest inrush currents.

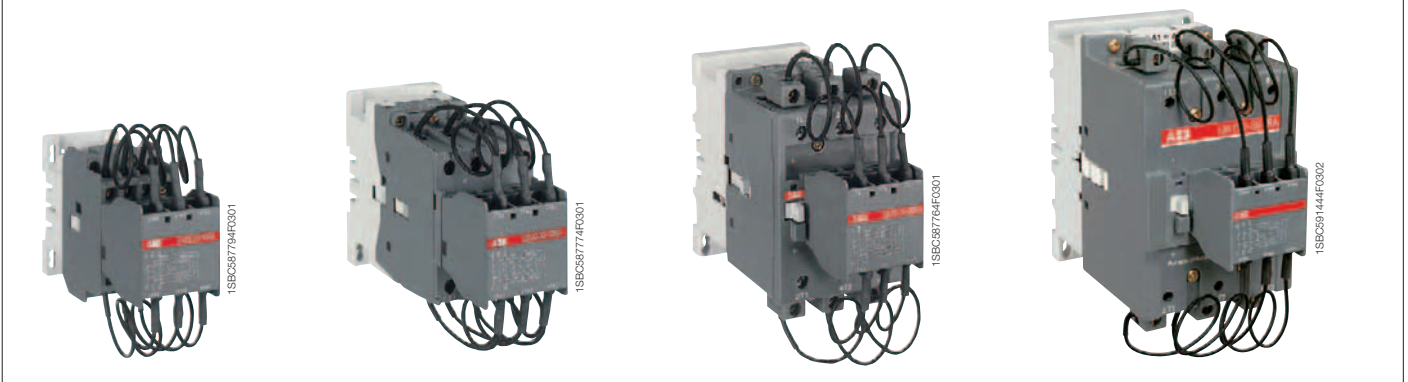

5

UA... contactors for capacitor switching (UA16 to UA110)

Maximum permissible peak current $\hat{I} \leq 100$ times the nominal rms current of the switched capacitor.

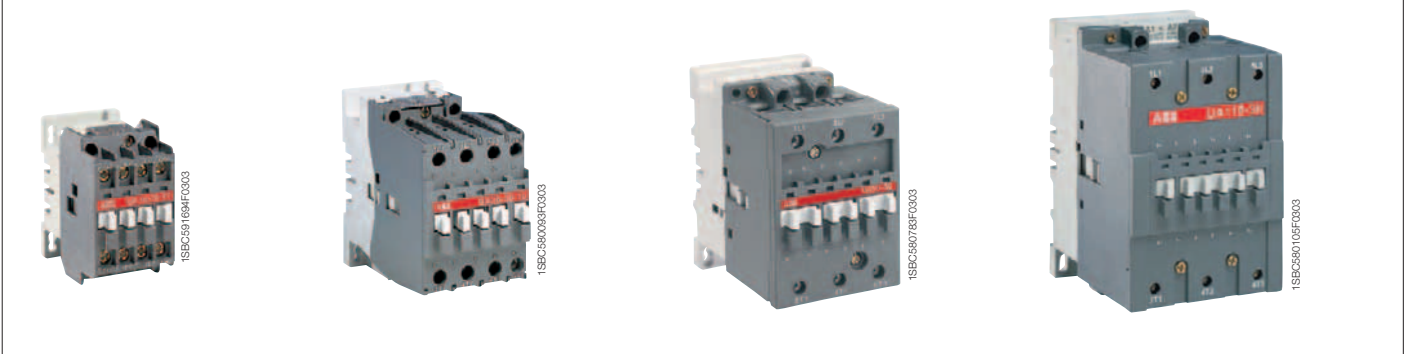

A... and AF... standard contactors

Maximum permissible peak current $\hat{I} \leq 30$ times the nominal rms current of the switched capacitor.

Please consult us.

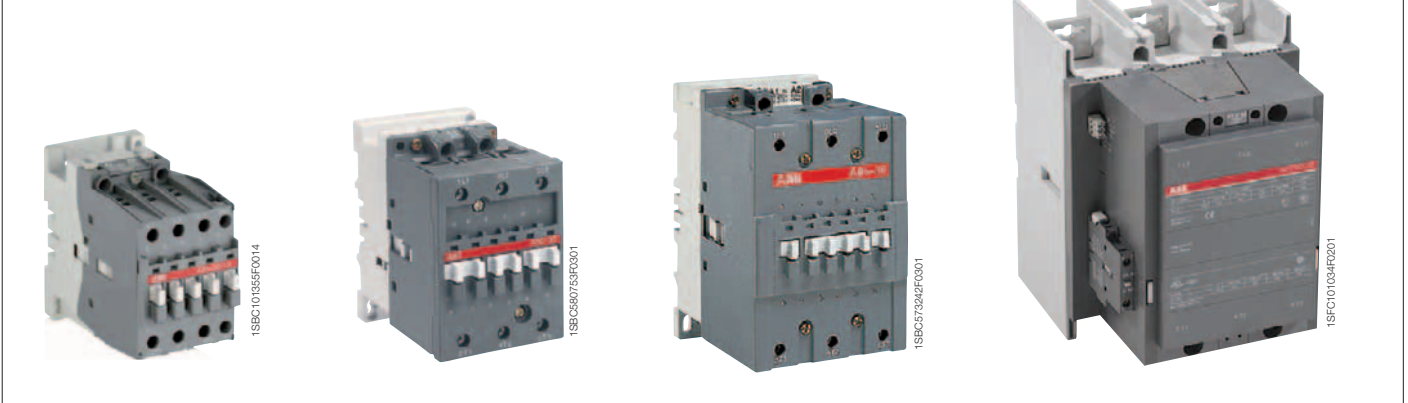

1SBC101604S0201

UA16..RA ... UA30..RA 3-pole contactors for capacitor switching 12.5 to 30 kvar - Unlimited peak current \hat{I} AC operated

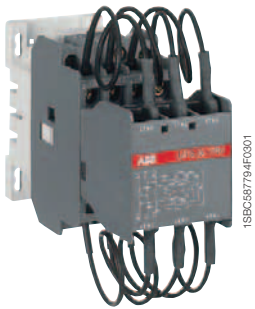

UA16-30-10RA

1SBC87794F0001



UA30-30-10RA

1SBC87774F0001

Description



UA..RA contactors for capacitor switching can be used for installations in which the peak current far exceeds 100 times nominal rms current. The contactors are delivered complete with their damping resistors and must be used without additional inductances.

The capacitors must be discharged (maximum residual voltage at terminals ≤ 50 V) before being re-energized when the contactors are making.

These contactors are of the block type design with:

- 3 main poles and 1 built-in auxiliary contact
- the UA..RA contactors are fitted with a special front-mounted block, which ensures the serial insertion of 3 damping resistors into the circuit to limit the current peak on energization of the capacitor bank
- their connection also ensures capacitor precharging in order to limit the second current peak occurring upon making of the main poles
- the insertion of resistors allows to damp the highest current peak of the capacitor when switching on, whatever its level.
- control circuit: AC operated
- add-on auxiliary contact blocks for side mounting and a wide range of accessories.

Ordering details

IEC Rated operational power $\theta \leq 40^\circ\text{C}$ 400 V AC-6b kvar	UL/CSA Rated operational power $\theta \leq 40^\circ\text{C}$ 480 V kvar	Rated control circuit voltage Uc (1)		Auxiliary contacts fitted  	Type	Order code	Weight Pkg (1 pce) kg
		V 50 Hz	V 60 Hz				
12.5	16	24	24	1 0	UA16-30-10RA	1SBL181024R8110	0.460
		48	48	1 0	UA16-30-10RA	1SBL181024R8310	0.460
		110	110...120	1 0	UA16-30-10RA	1SBL181024R8410	0.460
		220...230	230...240	1 0	UA16-30-10RA	1SBL181024R8010	0.460
		230...240	240...260	1 0	UA16-30-10RA	1SBL181024R8810	0.460
		380...400	400...415	1 0	UA16-30-10RA	1SBL181024R8510	0.460
22	22	400...415	415...440	1 0	UA16-30-10RA	1SBL181024R8610	0.460
		24	24	1 0	UA26-30-10RA	1SBL241024R8110	0.710
		48	48	1 0	UA26-30-10RA	1SBL241024R8310	0.710
		110	110...120	1 0	UA26-30-10RA	1SBL241024R8410	0.710
		220...230	230...240	1 0	UA26-30-10RA	1SBL241024R8010	0.710
		230...240	240...260	1 0	UA26-30-10RA	1SBL241024R8810	0.710
30	28	380...400	400...415	1 0	UA26-30-10RA	1SBL241024R8510	0.710
		400...415	415...440	1 0	UA26-30-10RA	1SBL241024R8610	0.710
		24	24	1 0	UA30-30-10RA	1SBL281024R8110	0.810
		48	48	1 0	UA30-30-10RA	1SBL281024R8310	0.810
		110	110...120	1 0	UA30-30-10RA	1SBL281024R8410	0.810
		220...230	230...240	1 0	UA30-30-10RA	1SBL281024R8010	0.810
230...240	240...260	1 0	UA30-30-10RA	1SBL281024R8810	0.810		
380...400	400...415	1 0	UA30-30-10RA	1SBL281024R8510	0.810		
400...415	415...440	1 0	UA30-30-10RA	1SBL281024R8610	0.810		

(1) Other control voltages see voltage code table.

Main dimensions mm, inches

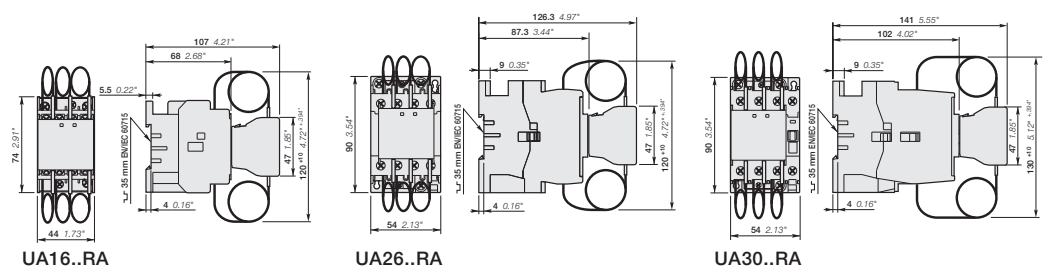

1SBC101507S0201

UA50..RA ... UA75..RA 3-pole contactors for capacitor switching 40 to 60 kvar - Unlimited peak current \hat{I} AC operated

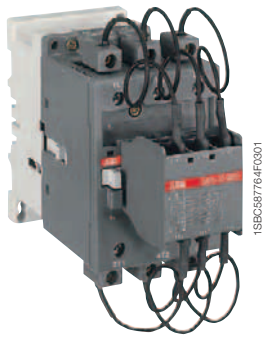

UA75-30-00 RA

Description

UA..RA contactors for capacitor switching can be used for installations in which the peak current far exceeds 100 times nominal rms current. The contactors are delivered complete with their damping resistors and must be used without additional inductances.

The capacitors must be discharged (maximum residual voltage at terminals ≤ 50 V) before being re-energized when the contactors are making.

These contactors are of the block type design with:

- 3 main poles
- the UA..RA contactors are fitted with a special front-mounted block, which ensures the serial insertion of 3 damping resistors into the circuit to limit the current peak on energization of the capacitor bank
 - their connection also ensures capacitor precharging in order to limit the second current peak occurring upon making of the main poles
 - the insertion of resistors allows to damp the highest current peak of the capacitor when switching on, whatever its level.
- control circuit: AC operated
- add-on auxiliary contact blocks for side mounting and a wide range of accessories.

Ordering details

IEC Rated operational power $\theta \leq 40^\circ\text{C}$ 400 V AC-6b kvar	UL/CSA Rated operational power $\theta \leq 40^\circ\text{C}$ 480 V kvar	Rated control circuit voltage Uc (1)		Auxiliary contacts fitted 	Type	Order code	Weight Pkg (1 pce) kg
		V 50 Hz	V 60 Hz				
40	50	24	24	0 0	UA50-30-00RA	1SBL351024R8100	1.350
		48	48	0 0	UA50-30-00RA	1SBL351024R8300	1.350
		110	110...120	0 0	UA50-30-00RA	1SBL351024R8400	1.350
		220...230	230...240	0 0	UA50-30-00RA	1SBL351024R8000	1.350
		230...240	240...260	0 0	UA50-30-00RA	1SBL351024R8800	1.350
		380...400	400...415	0 0	UA50-30-00RA	1SBL351024R8500	1.350
		400...415	415...440	0 0	UA50-30-00RA	1SBL351024R8600	1.350
50	55	24	24	0 0	UA63-30-00RA	1SBL371024R8100	1.350
		48	48	0 0	UA63-30-00RA	1SBL371024R8300	1.350
		110	110...120	0 0	UA63-30-00RA	1SBL371024R8400	1.350
		220...230	230...240	0 0	UA63-30-00RA	1SBL371024R8000	1.350
		230...240	240...260	0 0	UA63-30-00RA	1SBL371024R8800	1.350
		380...400	400...415	0 0	UA63-30-00RA	1SBL371024R8500	1.350
		400...415	415...440	0 0	UA63-30-00RA	1SBL371024R8600	1.350
60	64	24	24	0 0	UA75-30-00RA	1SBL411024R8100	1.350
		48	48	0 0	UA75-30-00RA	1SBL411024R8300	1.350
		110	110...120	0 0	UA75-30-00RA	1SBL411024R8400	1.350
		220...230	230...240	0 0	UA75-30-00RA	1SBL411024R8000	1.350
		230...240	240...260	0 0	UA75-30-00RA	1SBL411024R8800	1.350
		380...400	400...415	0 0	UA75-30-00RA	1SBL411024R8500	1.350
		400...415	415...440	0 0	UA75-30-00RA	1SBL411024R8600	1.350

(1) Other control voltages see voltage code table.

Main dimensions mm, inches

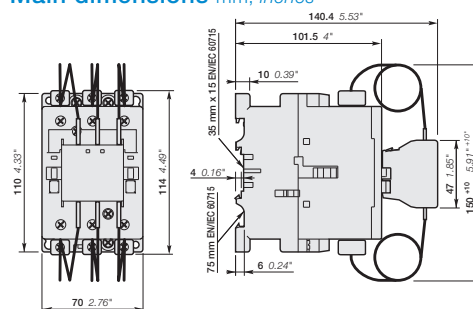

UA50..RA, UA63..RA, UA75..RA

UA95..RA ... UA110..RA 3-pole contactors for capacitor switching 70 to 80 kvar - Unlimited peak current \hat{I} AC operated



UA110-30-00 RA

1SBC39144F0302

Description

UA..RA contactors for capacitor switching can be used for installations in which the peak current far exceeds 100 times nominal rms current. The contactors are delivered complete with their damping resistors and must be used without additional inductances.

The capacitors must be discharged (maximum residual voltage at terminals ≤ 50 V) before being re-energized when the contactors are making.

These contactors are of the block type design with:

- 3 main poles
- the UA..RA contactors are fitted with a special front-mounted block, which ensures the serial insertion of 3 damping resistors into the circuit to limit the current peak on energization of the capacitor bank
- their connection also ensures capacitor precharging in order to limit the second current peak occurring upon making of the main poles
- the insertion of resistors allows to damp the highest current peak of the capacitor when switching on, whatever its level.
- control circuit: AC operated
- add-on auxiliary contact blocks for side mounting and a wide range of accessories.

Ordering details

IEC Rated operational power $\theta \leq 40^\circ\text{C}$ 400 V AC-6b	UL/CSA Rated operational power $\theta \leq 40^\circ\text{C}$ 480 V	Rated control circuit voltage Uc (1)		Auxiliary contacts fitted 	Type	Order code	Weight Pkg (1 pce) kg
		V 50 Hz	V 60 Hz				
70	80	24	24	0 0	UA95-30-00RA	1SFL431024R8100	2.000
		48	48	0 0	UA95-30-00RA	1SFL431024R8300	2.000
		110	110...120	0 0	UA95-30-00RA	1SFL431024R8400	2.000
		220...230	230...240	0 0	UA95-30-00RA	1SFL431024R8000	2.000
		230...240	240...260	0 0	UA95-30-00RA	1SFL431024R8800	2.000
		380...400	400...415	0 0	UA95-30-00RA	1SFL431024R8500	2.000
		400...415	415...440	0 0	UA95-30-00RA	1SFL431024R8600	2.000
80	95	24	24	0 0	UA110-30-00RA	1SFL451024R8100	2.000
		48	48	0 0	UA110-30-00RA	1SFL451024R8300	2.000
		110	110...120	0 0	UA110-30-00RA	1SFL451024R8400	2.000
		220...230	230...240	0 0	UA110-30-00RA	1SFL451024R8000	2.000
		230...240	240...260	0 0	UA110-30-00RA	1SFL451024R8800	2.000
		380...400	400...415	0 0	UA110-30-00RA	1SFL451024R8500	2.000
		400...415	415...440	0 0	UA110-30-00RA	1SFL451024R8600	2.000

(1) Other control voltages see voltage code table.

Main dimensions mm, inches

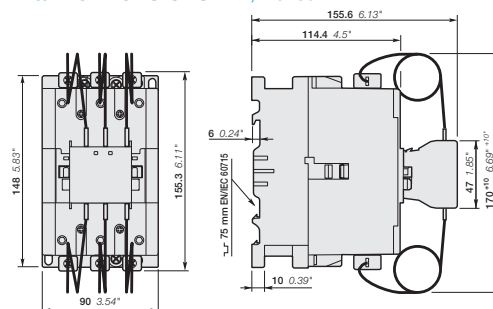

UA95..RA, UA100..RA

1SBC101653S0201

UA16..RA ... UA110..RA 3-pole contactors for capacitor switching

Unlimited peak current \hat{I}

Technical data

Main pole - Utilization characteristics according to IEC

Contactor types	AC operated	UA16..RA	UA26..RA	UA30..RA	UA50..RA	UA63..RA	UA75..RA	UA95..RA	UA110..RA
Standards		IEC 60947-1 / 60947-4-1 and EN 60947-1 / 60947-4-1							
Rated operational voltage U_e max.		690 V							
Rated frequency (without derating)		50 / 60 Hz							
AC-6b Utilization category									
Rated operational power AC-6b									
For air temperature close to contactor $\theta \leq 40^\circ\text{C}$	230-240 V	8 kvar	12.5 kvar	16 kvar	25 kvar	30 kvar	35 kvar	40 kvar	45 kvar
	400-415 V	12.5 kvar	22 kvar	30 kvar	40 kvar	50 kvar	60 kvar	70 kvar	80 kvar
For air temperature close to contactor $\theta \leq 55^\circ\text{C}$	440 V	15 kvar	24 kvar	32 kvar	50 kvar	55 kvar	65 kvar	75 kvar	85 kvar
	500-550 V	18 kvar	30 kvar	34 kvar	55 kvar	65 kvar	75 kvar	85 kvar	95 kvar
	690 V	22 kvar	35 kvar	45 kvar	72 kvar	80 kvar	100 kvar	120 kvar	130 kvar
For air temperature close to contactor $\theta \leq 70^\circ\text{C}$	230-240 V	7.5 kvar	11.5 kvar	16 kvar	24 kvar	27 kvar	30 kvar	35 kvar	40 kvar
	400-415 V	12.5 kvar	20 kvar	27.5 kvar	40 kvar	45 kvar	50 kvar	60 kvar	70 kvar
	440 V	13 kvar	20 kvar	30 kvar	43 kvar	48 kvar	53 kvar	65 kvar	75 kvar
	500-550 V	16 kvar	25 kvar	34 kvar	50 kvar	60 kvar	65 kvar	75 kvar	82 kvar
	690 V	21 kvar	31 kvar	45 kvar	65 kvar	75 kvar	80 kvar	105 kvar	110 kvar
	230-240 V	6 kvar	9 kvar	11 kvar	20 kvar	23 kvar	25 kvar	30 kvar	35 kvar
	400-415 V	10 kvar	15.5 kvar	19.5 kvar	35 kvar	39 kvar	41 kvar	53 kvar	60 kvar
	440 V	11 kvar	17 kvar	20.5 kvar	37 kvar	42.5 kvar	45 kvar	58 kvar	70 kvar
	500-550 V	12.5 kvar	20 kvar	25 kvar	46 kvar	50 kvar	55 kvar	70 kvar	78 kvar
	690 V	17 kvar	26 kvar	32 kvar	60 kvar	65 kvar	70 kvar	85 kvar	100 kvar
Max. permissible peak current \hat{I}		Unlimited							
Short-circuit protection device for contactors									
gG type fuse (1)		80 A	125 A	200 A				250 A	
Max. electrical switching frequency		240 cycles/h							
Electrical durability AC-6b									
	$U_e \leq 440\text{ V}$	250 000 operating cycles							
	$500\text{ V} \leq U_e \leq 690\text{ V}$	100 000 operating cycles							

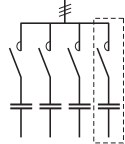

Multi-step capacitor bank scheme

(1) The fuse ratings given represent the maximum ratings ensuring type 1 coordination according to the definition of standard IEC 60947-4-1.

Main pole - Utilization characteristics according to UL / CSA

Contactor types	AC operated	UA16..RA	UA26..RA	UA30..RA	UA50..RA	UA63..RA	UA75..RA	UA95..RA	UA110..RA
Power - 60 Hz									
For air temperature close to contactor $\theta \leq 40^\circ\text{C}$	240 V	8 kvar	11 kvar	14 kvar	25 kvar	27.5 kvar	32 kvar	40 kvar	45 kvar
	480 V	16 kvar	22 kvar	28 kvar	50 kvar	55 kvar	64 kvar	80 kvar	95 kvar
	600 V	20 kvar	27 kvar	35 kvar	62 kvar	70 kvar	80 kvar	100 kvar	120 kvar
Max. permissible peak Current \hat{I}		Unlimited							

Operating principle

The front-mounted block mechanism of the UA..RA contactors ensures:

- early making of the auxiliary "PA" poles with respect to the main "PP" poles
- automatic return to the open position of the auxiliary "PA" poles after the main poles are closed.

When the coil is energized, the early making auxiliary poles connect the capacitor to the network via the set of 3 resistors. The damping resistors attenuate the first current peak and the second inrush current when the main contacts begin to make. Once the main poles are in the closed position, the auxiliary poles automatically break.

When the coil is de-energized, the main poles break ensuring the breaking of the capacitor bank.

The contactor can then begin a new cycle.

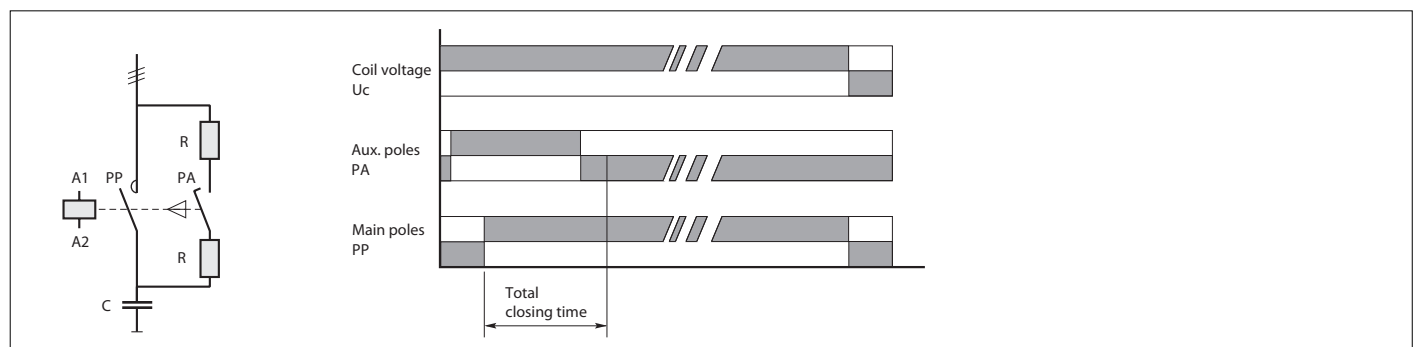







The insertion of resistors allows to damp the highest current peak of the capacitor when switching on, whatever its level.

UA16..RA ... UA110..RA 3-pole contactors for capacitor switching

Unlimited peak current \hat{I}

Technical data

Connecting characteristics

Contactor types		AC operated	UA16..RA	UA26..RA	UA30..RA	UA50..RA UA63..RA UA75..RA	UA95..RA UA110..RA
Connection capacity (min. ... max.)							
Main conductors (poles)							
	Rigid	Solid ($\leq 4 \text{ mm}^2$)	1 x 1...4 mm ²	1.5...6 mm ²	2.5...16 mm ²	6...50 mm ²	10...95 mm ²
		Stranded ($\geq 6 \text{ mm}^2$)	2 x -	-	2.5...16 + 2.5...6 mm ²	6...25 + 6...16 mm ²	6...35 mm ²
	Flexible with ferrule		1 x 0.75...2.5 mm ²	1.5...4 mm ²	2.5...10 mm ²	6...35 mm ²	10...70 mm ²
			2 x -	-	2.5...10 + 2.5...4 mm ²	6...16 + 6...10 mm ²	6...35 mm ²
	Bars or lugs		L \leq 7.7 mm	10 mm	-	-	-
			L $>$ 3.7 mm	4.2 mm	-	-	-
Connection capacity acc. to UL/CSA			1 or 2 x AWG 18...10	AWG 12...8	AWG 8...4	AWG 8...1	AWG 6...2/0
Tightening torque		Recommended	1 Nm / 9 lb.in	1.7 Nm / 15 lb.in	2.3 Nm / 20 lb.in	4 Nm / 35 lb.in	8 Nm / 53 lb.in
		Max.	1.2 Nm	2.2 Nm	2.6 Nm	4.5 Nm	9 Nm
Auxiliary conductors (built-in auxiliary terminals + coil terminals)							
	Rigid solid		1 x 1...4 mm ²	-	-	-	0.75...2.5 mm ²
			2 x 1...4 mm ²	-	-	-	0.75...2.5 mm ²
	Flexible with ferrule		1 x 0.75...2.5 mm ²	-	-	1...2.5 mm ²	0.75...2.5 mm ²
			2 x 0.75...2.5 mm ²	-	-	-	0.75...2.5 mm ²
	Lugs	Coil terminals	L \leq 8 mm	-	-	-	-
			L $>$ 3.7 mm	-	-	-	-
		Built-in auxiliary terminals	L \leq 7.7 mm	10 mm	8 mm	-	-
			L $>$ 3.7 mm	4.2 mm	3.7 mm	-	-
Connection capacity acc. to UL/CSA			1 or 2 x AWG 18...14	-	-	-	-
Tightening torque			-	-	-	-	-
Coil terminals		Recommended	1 Nm / 9 lb.in	-	-	-	-
		Max.	1.2 Nm	-	-	-	-
Built-in auxiliary terminals		Recommended	1 Nm / 9 lb.in	-	-	-	-
		Max.	1.2 Nm	-	-	-	-
Degree of protection							
acc. to IEC 60947-1 / EN 60947-1 and IEC 60529 / EN 60529							
Main terminals			IP20	-	IP10	-	-
Coil terminals			IP20	-	-	-	-
Built-in auxiliary terminals			IP20	-	-	-	-
Screw terminals							
Delivered in open position, screws of unused terminals must be tightened							
Main terminals			M 3.5	M 4	M 5	M 6	M 8
		Screwdriver type	Flat \varnothing 5.5 / Pozidriv 2		Flat \varnothing 6.5 / Pozidriv 2		Hexagon socket (s = 4 mm)
Coil terminals			M 3.5	-	-	-	-
		Screwdriver type	Flat \varnothing 5.5 / Pozidriv 2		-	-	-
Built-in auxiliary terminals			M 3.5	M 4	M 3.5	-	-
		Screwdriver type	Flat \varnothing 5.5 / Pozidriv 2		-	-	-

Other technical characteristics are the same as those of standard A contactors.

UA16 ... UA30 3-pole contactors for capacitor switching

12.5 to 27.5 kvar - peak current $\hat{I} \leq 100$ times the rms current

AC operated

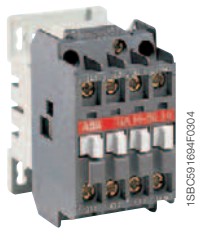

UA16-30-10



UA30-30-10

Description

UA contactors can be used for the switching of capacitor banks whose inrush current peaks are less than or equal to 100 times nominal rms current.

The capacitors must be discharged (maximum residual voltage at terminals ≤ 50 V) before being re-energized when the contactors are making.

These contactors are of the block type design with:

- 3 main poles and 1 built-in auxiliary contact
- control circuit: AC operated
- add-on auxiliary contact blocks for front or side mounting and a wide range of accessories.

Ordering details

IEC Rated operational power $\theta \leq 40^\circ\text{C}$ 400 V AC-6b kvar	Max peak current \hat{I} kA	UL/CSA Rated operational power $\theta \leq 40^\circ\text{C}$ 480 V kvar	Rated control circuit voltage U_c (1)		Auxiliary contacts fitted 	Type	Order code	Weight Pkg (1 pce) kg
			V 50 Hz	V 60 Hz				
12.5	1.8		24	24	1 0	UA16-30-10	1SBL181022R8110	0.340
			48	48	1 0	UA16-30-10	1SBL181022R8310	0.340
			110	110...120	1 0	UA16-30-10	1SBL181022R8410	0.340
			220...230	230...240	1 0	UA16-30-10	1SBL181022R8010	0.340
			230...240	240...260	1 0	UA16-30-10	1SBL181022R8810	0.340
			380...400	400...415	1 0	UA16-30-10	1SBL181022R8510	0.340
20	3	25	400...415	415...440	1 0	UA16-30-10	1SBL181022R8610	0.340
			24	24	1 0	UA26-30-10	1SBL241022R8110	0.600
			48	48	1 0	UA26-30-10	1SBL241022R8310	0.600
			110	110...120	1 0	UA26-30-10	1SBL241022R8410	0.600
			220...230	230...240	1 0	UA26-30-10	1SBL241022R8010	0.600
			230...240	240...260	1 0	UA26-30-10	1SBL241022R8810	0.600
27.5	3.5	32	380...400	400...415	1 0	UA26-30-10	1SBL241022R8510	0.600
			400...415	415...440	1 0	UA26-30-10	1SBL241022R8610	0.600
			24	24	1 0	UA30-30-10	1SBL281022R8110	0.710
			48	48	1 0	UA30-30-10	1SBL281022R8310	0.710
			110	110...120	1 0	UA30-30-10	1SBL281022R8410	0.710
			220...230	230...240	1 0	UA30-30-10	1SBL281022R8010	0.710
			230...240	240...260	1 0	UA30-30-10	1SBL281022R8810	0.710
			380...400	400...415	1 0	UA30-30-10	1SBL281022R8510	0.710
			400...415	415...440	1 0	UA30-30-10	1SBL281022R8610	0.710

(1) Other control voltages see voltage code table.

Main dimensions mm, inches

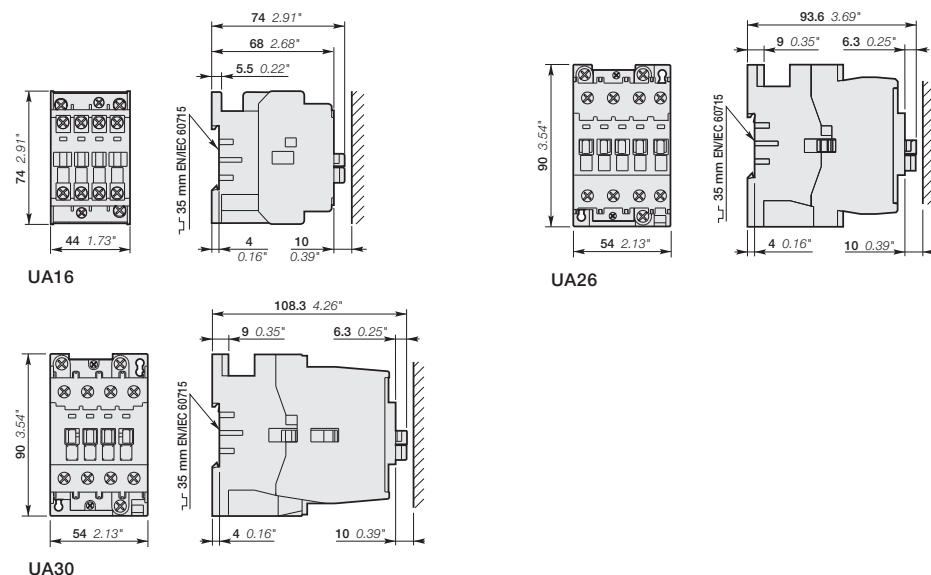

UA50 ... UA75 3-pole contactors for capacitor switching

33 to 50 kvar - peak current $\hat{I} \leq 100$ times the rms current

AC operated



UA50-30-00

Description

UA contactors can be used for the switching of capacitor banks whose inrush current peaks are less than or equal to 100 times nominal rms current.

The capacitors must be discharged (maximum residual voltage at terminals ≤ 50 V) before being re-energized when the contactors are making.

These contactors are of the block type design with:

- 3 main poles
- control circuit: AC operated
- add-on auxiliary contact blocks for front or side mounting and a wide range of accessories.

Ordering details

IEC Rated operational power $\theta \leq 40^\circ\text{C}$ 400 V AC-6b	Max peak current \hat{I} kA	UL/CSA Rated operational power $\theta \leq 40^\circ\text{C}$ 480 V	Rated control circuit voltage U_c (1)		Auxiliary contacts fitted		Type	Order code	Weight Pkg (1 pce) kg
			V 50 Hz	V 60 Hz	$\left \right $	$\left \right $			
33	5	40	24	24	0	0	UA50-30-00	1SBL351022R8100	1.160
			48	48	0	0	UA50-30-00	1SBL351022R8300	1.160
			110	110...120	0	0	UA50-30-00	1SBL351022R8400	1.160
			220...230	230...240	0	0	UA50-30-00	1SBL351022R8000	1.160
			230...240	240...260	0	0	UA50-30-00	1SBL351022R8800	1.160
			380...400	400...415	0	0	UA50-30-00	1SBL351022R8500	1.160
			400...415	415...440	0	0	UA50-30-00	1SBL351022R8600	1.160
45	6.5	-	24	24	0	0	UA63-30-00	1SBL371022R8100	1.160
			48	48	0	0	UA63-30-00	1SBL371022R8300	1.160
			110	110...120	0	0	UA63-30-00	1SBL371022R8400	1.160
			220...230	230...240	0	0	UA63-30-00	1SBL371022R8000	1.160
			230...240	240...260	0	0	UA63-30-00	1SBL371022R8800	1.160
			380...400	400...415	0	0	UA63-30-00	1SBL371022R8500	1.160
			400...415	415...440	0	0	UA63-30-00	1SBL371022R8600	1.160
50	7.5	55	24	24	0	0	UA75-30-00	1SBL411022R8100	1.160
			48	48	0	0	UA75-30-00	1SBL411022R8300	1.160
			110	110...120	0	0	UA75-30-00	1SBL411022R8400	1.160
			220...230	230...240	0	0	UA75-30-00	1SBL411022R8000	1.160
			230...240	240...260	0	0	UA75-30-00	1SBL411022R8800	1.160
			380...400	400...415	0	0	UA75-30-00	1SBL411022R8500	1.160
			400...415	415...440	0	0	UA75-30-00	1SBL411022R8600	1.160

(1) Other control voltages see voltage code table.

Main dimensions mm, inches

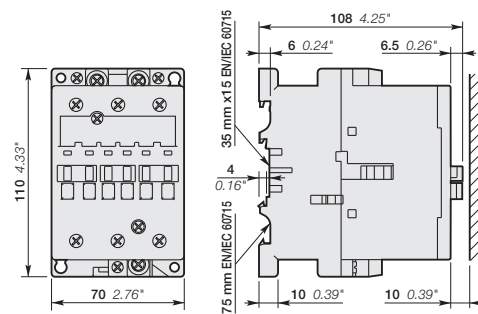

UA50, UA63, UA75

UA95 ... UA110 3-pole contactors for capacitor switching 65 to 75 kvar - peak current $\hat{I} \leq 100$ times the rms current AC operated



UA110-30-00

Description

UA contactors can be used for the switching of capacitor banks whose inrush current peaks are less or equal to 100 times nominal rms current. The capacitors must be discharged (maximum residual voltage at terminals ≤ 50 V) before being re-energized when the contactors are making.

These contactors are of the block type design with:

- 3 main poles
- control circuit: AC operated
- add-on auxiliary contact blocks for front or side mounting and a wide range of accessories.

Ordering details

IEC Rated operational power $\theta \leq 40^\circ\text{C}$ 400 V AC-6b kvar	Max peak current \hat{I} kA	UL/CSA Rated operational power $\theta \leq 40^\circ\text{C}$ 480 V kvar	Rated control circuit voltage U_c (1)		Auxiliary contacts fitted 	Type	Order code	Weight Pkg (1 pce) kg
			V 50 Hz	V 60 Hz				
65	9.3	70	24	24	0 0	UA95-30-00	1SFL431022R8100	2.000
			48	48	0 0	UA95-30-00	1SFL431022R8300	2.000
			110	110...120	0 0	UA95-30-00	1SFL431022R8400	2.000
			220...230	230...240	0 0	UA95-30-00	1SFL431022R8000	2.000
			230...240	240...260	0 0	UA95-30-00	1SFL431022R8800	2.000
			380...400	400...415	0 0	UA95-30-00	1SFL431022R8500	2.000
400...415	415...440	0 0	UA95-30-00	1SFL431022R8600	2.000			
75	10.5	80	24	24	0 0	UA110-30-00	1SFL451022R8100	2.000
			48	48	0 0	UA110-30-00	1SFL451022R8300	2.000
			110	110...120	0 0	UA110-30-00	1SFL451022R8400	2.000
			220...230	230...240	0 0	UA110-30-00	1SFL451022R8000	2.000
			230...240	240...260	0 0	UA110-30-00	1SFL451022R8800	2.000
			380...400	400...415	0 0	UA110-30-00	1SFL451022R8500	2.000
400...415	415...440	0 0	UA110-30-00	1SFL451022R8600	2.000			

(1) Other control voltages see voltage code table.

Main dimensions mm, inches

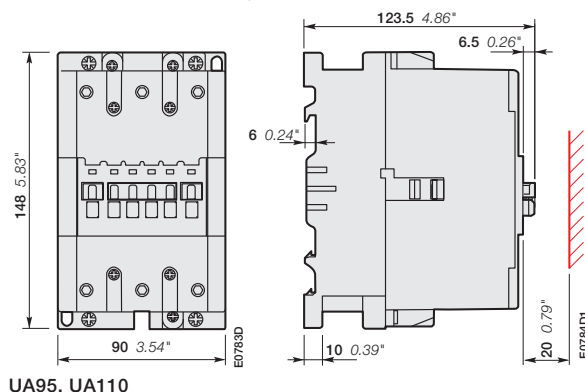

UA16 ... UA110 3-pole contactors for capacitor switching

Peak current $\hat{I} \leq 100$ times the rms current

Technical data

Main pole - Utilization characteristics according to IEC

Contactor types	AC operated	UA16	UA26	UA30	UA50	UA63	UA75	UA95	UA110	
Standards		IEC 60947-1 / 60947-4-1 and EN 60947-1 / 60947-4-1								
Rated operational voltage U_e max.		690 V								
Rated frequency (without derating)		50 / 60 Hz								
AC-6b Utilization category										
Rated operational power AC-6b (1)										
For air temperature close to contactor	$\theta \leq 40^\circ\text{C}$	230-240 V	7.5 kvar	12 kvar	16 kvar	20 kvar	25 kvar	30 kvar	35 kvar	40 kvar
		400-415 V	12.5 kvar	20 kvar	27.5 kvar	33 kvar	45 kvar	50 kvar	65 kvar	75 kvar
	$\theta \leq 55^\circ\text{C}$	440 V	13.7 kvar	22 kvar	30 kvar	36 kvar	50 kvar	55 kvar	65 kvar	75 kvar
		500-550 V	15.5 kvar	22 kvar	34 kvar	40 kvar	50 kvar	62 kvar	70 kvar	80 kvar
	$\theta \leq 70^\circ\text{C}$	690 V	21.5 kvar	30 kvar	45 kvar	55 kvar	70 kvar	75 kvar	80 kvar	90 kvar
		230-240 V	6.7 kvar	11 kvar	16 kvar	20 kvar	25 kvar	30 kvar	35 kvar	40 kvar
		400-415 V	11.7 kvar	18.5 kvar	27.5 kvar	33 kvar	43 kvar	50 kvar	65 kvar	70 kvar
		440 V	13 kvar	20 kvar	30 kvar	36 kvar	48 kvar	53 kvar	65 kvar	75 kvar
		500-550 V	14.7 kvar	22 kvar	34 kvar	40 kvar	50 kvar	62 kvar	70 kvar	80 kvar
		690 V	20 kvar	30 kvar	45 kvar	55 kvar	70 kvar	75 kvar	80 kvar	90 kvar
		230-240 V	6 kvar	8.5 kvar	11 kvar	19 kvar	21 kvar	22 kvar	30 kvar	35 kvar
		400-415 V	10 kvar	14.5 kvar	19 kvar	32 kvar	37 kvar	39 kvar	55 kvar	65 kvar
		440 V	11 kvar	16 kvar	20 kvar	35 kvar	41 kvar	43 kvar	55 kvar	70 kvar
		500-550 V	12.5 kvar	19.5 kvar	23.5 kvar	40 kvar	45 kvar	47.5 kvar	60 kvar	75 kvar
		690 V	17 kvar	25 kvar	32 kvar	52 kvar	60 kvar	65 kvar	70 kvar	85 kvar
		$U_e \leq 500\text{ V}$	1.8 kA	3 kA	3.5 kA	5 kA	6.5 kA	7.5 kA	9.3 kA	10.5 kA
Max. permissible peak current \hat{I}		$U_e > 500\text{ V}$	1.6 kA	2.7 kA	3.1 kA	4.5 kA	5.8 kA	6.75 kA	8 kA	9 kA
		Short-circuit protection device for contactors								
gG type fuse		sized 1.5...1.8 I_n of the capacitor								
Max. electrical switching frequency		240 cycles/h								
Electrical durability AC-6b		$U_e \leq 690\text{ V}$: 100 000 operating cycles								

(1) For 220 V and 380 V, multiply by 0.9 the rated values at 230 V and 400 V respectively.

Example: 50 kvar / 400 V corresponding to $0.9 \times 50 = 45$ kvar/380 V.

If, in an application, the current peak is greater than the maximum peak current \hat{I} specified in the tables above, select a higher rating, refer to the UA..RA contactors, or add inductances. (see application guide "Contactors for capacitor switching").

Main pole - Utilization characteristics according to UL / CSA

Contactor types	AC operated	UA16	UA26	UA30	UA50	UA63	UA75	UA95	UA110	
Power - 60 Hz										
For air temperature close to contactor	$\theta \leq 40^\circ\text{C}$	240 V	-	12.5 kvar	16 kvar	20 kvar	-	27.5 kvar	35 kvar	40 kvar
		480 V	-	25 kvar	32 kvar	40 kvar	-	55 kvar	70 kvar	80 kvar
		600 V	-	30 kvar	40 kvar	50 kvar	-	70 kvar	75 kvar	85 kvar







If, in an application, the current peak is greater than the maximum peak current \hat{I} specified in the tables above, select a higher rating, refer to the UA..RA contactors, or add inductances. (see application guide "Contactors for capacitor switching").

UA16 ... UA110 3-pole contactors for capacitor switching

Peak current $\hat{I} \leq 100$ times the rms current

Technical data

Connecting characteristics

Contactor types	AC operated	UA16	UA26	UA30	UA50 UA63 UA75	UA95 UA110
Connection capacity (min. ... max.)						
Main conductors (poles)						
 Rigid	Solid ($\leq 4 \text{ mm}^2$)	1 x 1...4 mm ²	1.5...6 mm ²	2.5...16 mm ²	6...50 mm ²	10...95 mm ²
	Stranded ($\geq 6 \text{ mm}^2$)	2 x 1...4 mm ²	1.5...6 mm ²	2.5...16 mm ²	6...25 mm ²	6...35 mm ²
 Flexible with ferrule		1 x 0.75...2.5 mm ²	0.75...4 mm ²	2.5...10 mm ²	6...35 mm ²	10...70 mm ²
		2 x 0.75...2.5 mm ²	0.75...4 mm ²	2.5...10 mm ²	6...16 mm ²	6...35 mm ²
 Bars or lugs		L \leq 7.7 mm	10 mm	-	-	-
		l $>$ 3.7 mm	4.2 mm	-	-	-
Connection capacity acc. to UL/CSA		1 or 2 x AWG 18...10	AWG 12...8	AWG 8...4	AWG 8...1	AWG 6...2/0
Tightening torque						
	Recommended	1 Nm / 9 lb.in	1.7 Nm / 15 lb.in	2.3 Nm / 20 lb.in	4 Nm / 35 lb.in	8 Nm / 71 lb.in
	Max.	1.2 Nm	2.2 Nm	2.6 Nm	4.5 Nm	9 Nm
Auxiliary conductors (built-in auxiliary terminals + coil terminals)						
 Rigid solid		1 x 1...4 mm ²				0.75...2.5 mm ²
		2 x 1...4 mm ²				0.75...2.5 mm ²
 Flexible with ferrule		1 x 0.75...2.5 mm ²			1...2.5 mm ²	0.75...2.5 mm ²
		2 x 0.75...2.5 mm ²				
 Lugs	Coil terminals	L \leq 8 mm				
		l $>$ 3.7 mm				
	Built-in auxiliary terminals	L \leq 7.7 mm	10 mm	8 mm	-	-
		l $>$ 3.7 mm	4.2 mm	3.7 mm	-	-
Connection capacity acc. to UL/CSA		AWG 18...14				
Tightening torque						
	Coil terminals					
	Recommended	1 Nm / 9 lb.in				
	Max.	1.2 Nm				
	Built-in auxiliary terminals					
	Recommended	1 Nm / 9 lb.in				
	Max.	1.2 Nm				
Degree of protection acc. to IEC 60947-1 / EN 60947-1 and IEC 60529 / EN 60529						
Main terminals		IP20			IP10	
Coil terminals		IP20				
Built-in auxiliary terminals		IP20				
Screw terminals						
Main terminals		Delivered in open position, screws of unused terminals must be tightened				
		M3.5	M4	M5	M6	M8
	Screwdriver type	Flat \varnothing 5.5 / Pozidriv 2			Flat \varnothing 6.5 / Pozidriv 2	
Coil terminals		M3.5				
	Screwdriver type	Flat \varnothing 5.5 / Pozidriv 2				
Built-in auxiliary terminals		M3.5	M4	M3.5	-	-
	Screwdriver type	Flat \varnothing 5.5 / Pozidriv 2				

Other technical characteristics are the same as those of standard A contactors.



NF 4-pole contactor relays

Ordering details

NF	AC / DC operated	5/108
NFZ	AC / DC operated - low consumption	5/109
Main accessories		5/110

Technical data

Contacts utilization characteristics according to IEC		5/112
Contacts utilization characteristics according to UL / CSA		5/112
General technical data		5/113
Magnet system		5/113
Mounting characteristics		5/113
Connecting characteristics		5/114

Accessories

Accessories for NF contactor relays		5/115
-------------------------------------	--	-------

NF 4-pole contactor relays

AC / DC operated



NF22E

1SBCE10104F0014

Description

NF contactor relays are used for switching auxiliary and control circuits.

These contactor relays are of the block type design with:

- 4 poles. Contactor relays have mechanically linked auxiliary contact elements (side-marked symbol)
- control circuit: AC or DC operated with electronic coil interface accepting a wide control voltage range (e.g. 100...250 V AC and DC)
 - can manage large control voltage variations
 - only 4 coils to cover control voltages between 24...500 V 50/60 Hz and 20...500 V DC
 - reduced panel energy consumption
 - very distinct closing and opening.
- built-in surge suppression
- add-on auxiliary contact blocks for front or side mounting and a wide range of accessories.

Ordering details

Number of contacts	Rated control circuit voltage		Type	Order code	Weight
	Uc min. ... Uc max.				
	V 50/60 Hz	V DC			Pkg (1 pce)
					kg
	24...60	20...60	(1) NF22E-11	1SBH137001R1122	0.270
	48...130	48...130	NF22E-12	1SBH137001R1222	0.270
	100...250	100...250	NF22E-13	1SBH137001R1322	0.270
	250...500	250...500	NF22E-14	1SBH137001R1422	0.310
	24...60	20...60	(1) NF31E-11	1SBH137001R1131	0.270
	48...130	48...130	NF31E-12	1SBH137001R1231	0.270
	100...250	100...250	NF31E-13	1SBH137001R1331	0.270
	250...500	250...500	NF31E-14	1SBH137001R1431	0.310
	24...60	20...60	(1) NF40E-11	1SBH137001R1140	0.270
	48...130	48...130	NF40E-12	1SBH137001R1240	0.270
	100...250	100...250	NF40E-13	1SBH137001R1340	0.270
	250...500	250...500	NF40E-14	1SBH137001R1440	0.310

(1) NF..E-11 not suitable for direct control by PLC-output.

Main dimensions mm, inches

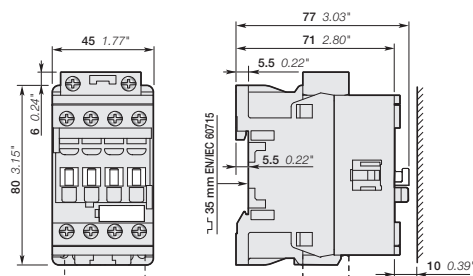

NF22E, NF31E, NF40E

1SBCE101558S0201

NFZ 4-pole contactor relays

AC / DC operated - low consumption



NFZ22E

1SBCT101104F0014

Description

NFZ contactor relays are used for switching auxiliary circuits and control circuits.

These contactor relays are of the block type design with:

- 4 poles. Contactor relays have mechanically linked auxiliary contact elements (side-marked symbol)
- control circuit: AC or DC operated with electronic coil interface accepting a wide control voltage range (e.g. 100...250 V AC and DC)
 - can manage large control voltage variations
 - only 4 coils to cover control voltages between 24...250 V 50/60 Hz and 12...250 V DC
 - allow direct control by PLC-output ≥ 24 V DC 500 mA
 - reduced panel energy consumption
 - very distinct closing and opening
 - can withstand short voltage dips and voltage sags (SEMI F47-0706 conditions of use on request).
- built-in surge suppression
- add-on auxiliary contact blocks for front or side mounting and a wide range of accessories.

Ordering details

Number of contacts	Rated control circuit voltage U_c min. ... U_c max.		Type	Order code	Weight Pkg (1 pce) kg
	V 50/60 Hz	V DC			
	-	12...20	NFZ22E-20	1SBH136001R2022	0.310
	24...60	20...60	NFZ22E-21	1SBH136001R2122	0.310
	48...130	48...130	NFZ22E-22	1SBH136001R2222	0.310
	100...250	100...250	NFZ22E-23	1SBH136001R2322	0.310
	-	12...20	NFZ31E-20	1SBH136001R2031	0.310
	24...60	20...60	NFZ31E-21	1SBH136001R2131	0.310
	48...130	48...130	NFZ31E-22	1SBH136001R2231	0.310
	100...250	100...250	NFZ31E-23	1SBH136001R2331	0.310
	-	12...20	NFZ40E-20	1SBH136001R2040	0.310
	24...60	20...60	NFZ40E-21	1SBH136001R2140	0.310
	48...130	48...130	NFZ40E-22	1SBH136001R2240	0.310
	100...250	100...250	NFZ40E-23	1SBH136001R2340	0.310

Note: Only NFZ contactor relays with DC control voltage 12...20 V DC need to respect the connection polarities indicated close to the coil terminals: A1+ for the positive pole and A2- for the negative pole.

Main dimensions mm, inches

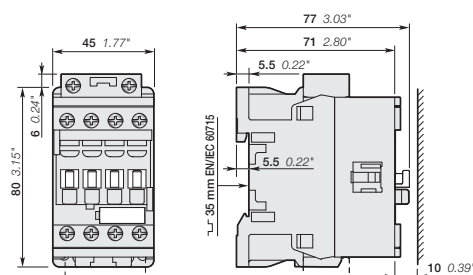

NFZ22E, NFZ31E, NFZ40E

NF 4-pole contactor relays

Main accessories

Contactor relays and main accessories (other accessories available)

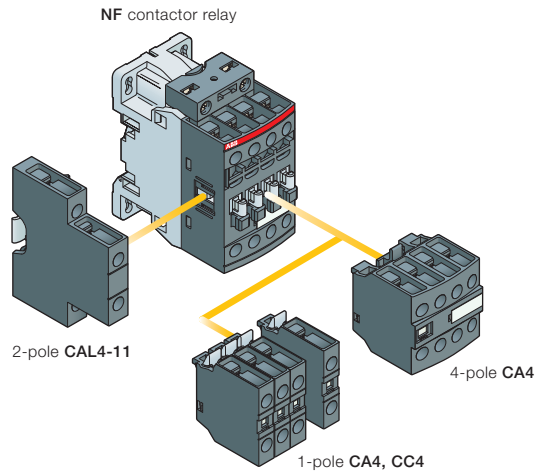

5

Main accessory fitting details

Many configurations of accessories are possible depending on whether these are front-mounted or side-mounted.

Contactor relay types	Main poles	Front-mounted accessories				Side-mounted accessories	
		Auxiliary contact blocks				Auxiliary contact blocks	
		1-pole CA4		1-pole CC4		4-pole CA4	
		Left side		Right side			
		2-pole CAL4-11					
		Max. add-on N.C. auxiliary contacts: 3 N.C. max. on positions 1, 2, 3, 4 and 2 N.C. max. on positions 1 ±30°, 5					
NF..	2 2 E	4 max.	or	1		+ 1	-
NF..	3 1 E	2 max.		-		+ 1	+ 1
		Max. add-on N.C. auxiliary contacts: 4 N.C. max. on positions 1, 2, 3, 4 and 3 N.C. max. on positions 1 ±30°, 5					
NF..	4 0 E	4 max.	or	1		+ 1	-
		2 max.		-		+ 1	+ 1

NF 4-pole contactor relays

Main accessories



CA4-10



CA4-22N



CAL4-11



LDC4



BX4



BX4-CA

Ordering details (1)

For contactor relays	Auxiliary contacts	Type	Order code	Pkg qty	Weight (1 pce)
					kg

Front-mounted instantaneous auxiliary contact blocks

4-pole NF	1 0	- -	CA4-10	1SBN010110R1010	1	0.014
	1 0	- -	CA4-10-T	1SBN010110T1010	10	0.014
	0 1	- -	CA4-01	1SBN010110R1001	1	0.014
	0 1	- -	CA4-01-T	1SBN010110T1001	10	0.014
	4 0	- -	CA4-40N	1SBN010140R1240	1	0.055
	3 1	- -	CA4-31N	1SBN010140R1231	1	0.055
	2 2	- -	CA4-22N	1SBN010140R1222	1	0.055
	1 3	- -	CA4-13N	1SBN010140R1213	1	0.055
	NF..40E	0 4	- -	CA4-04N	1SBN010140R1204	1

Front-mounted auxiliary contact blocks with N.O. leading contact and N.C. lagging contact

4-pole NF	- -	1 0	CC4-10	1SBN010111R1010	1	0.014
	- -	0 1	CC4-01	1SBN010111R1001	1	0.014

Side-mounted instantaneous auxiliary contact blocks

NF	1 1	- -	CAL4-11	1SBN010120R1011	1	0.040
	1 1	- -	CAL4-11-T	1SBN010120T1011	10	0.040

Additional coil terminal block

NF	LDC4	1SBN070156T1000	10	0.010
----	------	-----------------	----	-------

Protective covers

All 1-stack contactor relays	BX4	1SBN110108T1000	10	0.006
For 4-pole CA4 auxiliary contact blocks	BX4-CA	1SBN110109W1000	50	0.001

(1) See "Main accessory fitting details" table.

NF contactor relays

Technical data

Contact utilization characteristics according to IEC

Contactor relay types	AC / DC operated	NF
Standards	IEC 60947-1 / 60947-5-1 and EN 60947-1 / 60947-5-1	
Rated operational voltage U_e max.	690 V	
Rated frequency (without derating)	50 / 60 Hz	
Conventional free-air thermal current I_{th} $\theta \leq 40$ °C	16 A	
le / Rated operational current AC-15		
acc. to IEC 60947-5-1	24-127 V 50/60 Hz	6 A
	220-240 V 50/60 Hz	4 A
	400-440 V 50/60 Hz	3 A
	500 V 50/60 Hz	2 A
	690 V 50/60 Hz	2 A
Rated making capacity AC-15	10 x le AC-15 acc. to IEC 60947-5-1	
Rated breaking capacity AC-15	10 x le AC-15 acc. to IEC 60947-5-1	
le / Rated operational current DC-13		
acc. to IEC 60947-5-1	24 V DC	6 A / 144 W
	48 V DC	2.8 A / 134 W
	72 V DC	1 A / 72 W
	110 V DC	0.55 A / 60 W
	125 V DC	0.55 A / 69 W
	220 V DC	0.27 A / 60 W
	250 V DC	0.27 A / 68 W
	400 V DC	0.15 A / 60 W
	500 V DC	0.13 A / 65 W
	600 V DC	0.1 A / 60 W
Short-circuit protection device gG type fuse	10 A	
Rated short-time withstand current I_{cw}	for 1.0 s	100 A
	for 0.1 s	140 A
Minimum switching capacity	12 V / 3 mA	
with failure rate acc. to IEC 60947-5-4	10^{-7}	
Non-overlapping time between N.O. and N.C. contacts	≥ 2 ms	
Power dissipation per pole at 6 A	0.1 W	
Max. electrical switching frequency	AC-15	1200 cycles/h
	DC-13	900 cycles/h
Mechanically linked contacts	Built-in N.O. or N.C. auxiliary contacts and additional N.O. or N.C. auxiliary contacts (CA4, CAL4 aux. contact blocks) are mechanically linked contacts.	
acc. to annex L of IEC 60947-5-1		

Contact utilization characteristics according to UL / CSA

Contactor relay types	AC / DC operated	NF
Standards	UL 508, CSA C22.2 N°14	
Max. operational voltage	600 V AC, 600 V DC	
Pilot duty	A600, Q600	
AC thermal rated current	10 A	
AC maximum volt-ampere making	7200 VA	
AC maximum volt-ampere breaking	720 VA	
DC thermal rated current	2.5 A	
DC maximum volt-ampere making-breaking	69 VA	

NF contactor relays

Technical data

General technical data

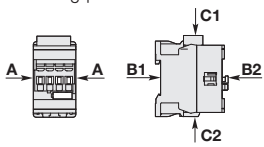
Contactor types	AC / DC operated	NF
Rated insulation voltage U_i acc. to IEC 60947-5-1 acc. to UL / CSA		690 V 600 V
Rated impulse withstand voltage U_{imp}		6 kV
Electromagnetic compatibility		Devices complying with IEC 60947-1 / EN 60947-1 - Environment A
Ambient air temperature close to contactor		
Operation in free air		-40...+70 °C
Storage		-60...+80 °C
Climatic withstand		Category B according to IEC 60947-1 Annex Q
Maximum operating altitude (without derating)		3000 m
Mechanical durability		
Number of operating cycles		20 millions operating cycles
Max. switching frequency		6000 cycles/h
Shock withstand acc. to IEC 60068-2-27 and EN 60068-2-27		
Mounting position 1	Shock direction	1/2 sinusoidal shock for 11 ms: no change in contact position, closed or open position
	A	30 g
	B1	25 g closed position / 5 g open position
	B2	15 g
	C1	25 g
	C2	25 g
Vibration withstand acc. to IEC 60068-2-6		5...300 Hz 4 g closed position / 2 g open position

Magnet system characteristics

Contactor relay types	AC / DC operated	NF
Coil operating limits acc. to IEC 60947-5-1	AC supply	At $\theta \leq 60$ °C $0.85 \times U_c \text{ min...} 1.1 \times U_c \text{ max.}$ At $\theta \leq 70$ °C $0.85 \times U_c \text{ min...} U_c \text{ max.}$
	DC supply	At $\theta \leq 60$ °C $0.85 \times U_c \text{ min...} 1.1 \times U_c \text{ max.}$ At $\theta \leq 70$ °C (AF) $0.85 \times U_c \text{ min...} U_c \text{ max.}$ - (NFZ) $0.85 \times U_c \text{ min...} 1.1 \times U_c \text{ max.}$
AC control voltage 50/60 Hz	Rated control circuit voltage U_c	24...500 V AC
	Coil consumption	Average pull-in value (NF) 50 VA - (NFZ) 16 VA Average holding value (NF) 2.2 VA / 2 W - (NFZ) 1.7 VA / 1.5 W
DC control voltage	Rated control circuit voltage U_c	12...500 V DC
	Coil consumption	Average pull-in value (NF) 50 W - (NFZ) 12...16 W Average holding value (NF) 2 W - (NFZ) 1.7 W
PLC-output control		(NFZ) ≥ 500 mA 24 V DC
Drop-out voltage		≤ 60 % of $U_c \text{ min.}$
Voltage sag immunity acc. to SEMI F47-0706		(NFZ) conditions of use on request
Dips withstand -20 °C $\leq \theta \leq$ +60 °C		(NFZ) 22 ms average
Operating time		
Between coil energization and:	N.O. contact closing	40...95 ms
	N.C. contact opening	38...90 ms
Between coil de-energization and:	N.O. contact opening	11...95 ms
	N.C. contact closing	13...98 ms



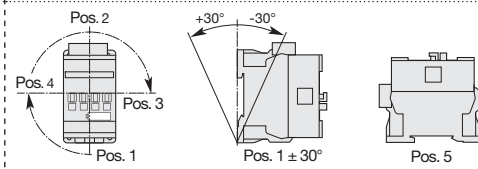





Mounting characteristics

Contactor types	AC / DC operated	NF
Mounting positions		
		Max. add-on N.C. auxiliary contacts: see accessory fitting details for a NF contactor relay
Mounting distances		The contactor relays can be assembled side by side.
Fixing	On rail according to IEC 60715, EN 60715 By screws (not supplied)	35 x 7.5 mm or 35 x 15 mm 2 x M4 screws placed diagonally

NF contactor relays

Technical data

Connecting characteristics

Contactor types	AC / DC operated	NF
Main terminals		
	Screw terminals with cable clamp	
Connection capacity (min. ... max.)		
Pole and coil terminals		
 Rigid	1 x	1...2.5 mm ²
 Rigid	2 x	1...2.5 mm ²
 Flexible with non insulated ferrule	1 x	0.75...2.5 mm ²
 Flexible with non insulated ferrule	2 x	0.75...2.5 mm ²
 Flexible with insulated ferrule	1 x	0.75...2.5 mm ²
 Flexible with insulated ferrule	2 x	0.75...1.5 mm ²
 Lugs	L <	8 mm
Connection capacity acc. to UL/CSA	1 or 2 x	AWG 18...14
Stripping length	10 mm	
Tightening torque		
Pole terminals	1.2 Nm / 11 lb.in	
Coil terminals	1.2 Nm / 11 lb.in	
Degree of protection		
acc. to IEC 60947-1 / EN 60947-1 and IEC 60529 / EN 60529		
All terminals	IP20	
Screw terminals		
All terminals	Delivered in open position, screws of unused terminals must be tightened	
		M3.5
	Screwdriver type	Flat Ø 5.5 / Pozidriv 2

5

Accessories for AF09 ... AF38 contactors and NF contactor relays

Auxiliary contact blocks	5/116
Interlocks	5/117
Mechanical latching unit	5/118
Connection accessories for starting solutions	5/119
Other accessories	5/120

Auxiliary contact blocks



CA4-10



CAL4-11



CA4-22M



CAT4-11E

5

Description

The auxiliary contact blocks are used for the operation of auxiliary circuits and control circuits for standard industrial environments.

Types of auxiliary contact blocks for front mounting:

- CA4 1 or 4-pole block, with instantaneous N.O., N.C. contacts
- CC4 1-pole block, with N.O. leading contact or N.C. lagging contact
- CAT4 2-pole block, with instantaneous N.O. + N.C. contacts and A1 / A2 coil terminal connection on front face.

Select the 4-pole auxiliary contact blocks CA4-..E, CA4-..M, CA4-..U or CA4-..N type, according to the contactor or contactor relay type for compliance with the standard requirements (see "Terminal marking and positioning").

Types of auxiliary contact blocks for side mounting:

- CAL4 2-pole block, with instantaneous N.O. + N.C. contacts.

For clipping onto the right and/or lefthand side of the contactors.

The auxiliary contact blocks are equipped with screw type connecting terminals delivered open, protected against accidental direct contact and bear the corresponding function marking.

Ordering details (1)

For contactors	Auxiliary contacts	Type	Order code	Pkg qty	Weight (1 pce)
					kg

Front-mounted instantaneous auxiliary contact blocks

AF09 ... AF38 4-pole NF	1 0 - -	CA4-10	1SBN010110R1010	1	0.014
	1 0 - -	CA4-10-T	1SBN010110T1010	10	0.014
	0 1 - -	CA4-01	1SBN010110R1001	1	0.014
	0 1 - -	CA4-01-T	1SBN010110T1001	10	0.014
AF09 ... AF16..-30-10	2 2 - -	CA4-22M	1SBN010140R1122	1	0.055
	3 1 - -	CA4-31M	1SBN010140R1131	1	0.055
	1 3 - -	CA4-13M	1SBN010140R1113	1	0.055
	0 4 - -	CA4-04M	1SBN010140R1104	1	0.055
AF26 ... AF38..-30-00	2 2 - -	CA4-22E	1SBN010140R1022	1	0.055
AF09 ... AF38..-40-00	3 1 - -	CA4-31E	1SBN010140R1031	1	0.055
AF09 ... AF38..-22-00	4 0 - -	CA4-40E	1SBN010140R1040	1	0.055
AF26 ... AF38..-30-00	0 4 - -	CA4-04E	1SBN010140R1004	1	0.055
AF09 ... AF16..-30-01	2 2 - -	CA4-22U	1SBN010140R1322	1	0.055
	3 1 - -	CA4-31U	1SBN010140R1331	1	0.055
	4 0 - -	CA4-40U	1SBN010140R1340	1	0.055
	4 0 - -	CA4-40N	1SBN010140R1240	1	0.055
4-pole NF	3 1 - -	CA4-31N	1SBN010140R1231	1	0.055
	2 2 - -	CA4-22N	1SBN010140R1222	1	0.055
	1 3 - -	CA4-13N	1SBN010140R1213	1	0.055
	0 4 - -	CA4-04N	1SBN010140R1204	1	0.055
NF..40E	0 4 - -	CA4-04N	1SBN010140R1204	1	0.055

Front-mounted auxiliary contact blocks with N.O. leading contact and N.C. lagging contact

AF09 ... AF38 4-pole NF	- - 1 0	CC4-10	1SBN010111R1010	1	0.014
	- - 0 1	CC4-01	1SBN010111R1001	1	0.014

Side-mounted instantaneous auxiliary contact blocks

AF09 ... AF38 NF	1 1 - -	CAL4-11	1SBN010120R1011	1	0.040
	1 1 - -	CAL4-11-T	1SBN010120T1011	10	0.040

Front-mounted instantaneous auxiliary contact and A1/A2 coil terminal blocks

AF09 ... AF16..-30-10	1 1 - -	CAT4-11M	1SBN010151R1111	1	0.040
AF26 ... AF38..-30-00	1 1 - -	CAT4-11E	1SBN010151R1011	1	0.040
AF09 ... AF38..-40-00					
AF09 ... AF38..-22-00					
AF09 ... AF16..-30-01	1 1 - -	CAT4-11U	1SBN010151R1311	1	0.040

(1) For each contactor or contactor relay type, refer to "Accessory fitting details" table.

Note: CAT4 not fittable on AF.Z contactors with DC control voltage 12...20 V DC.

1SBC101573S0201

Interlocks

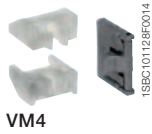

Mechanical interlock unit

VM4 mechanical interlock unit for the interlocking of two AF contactors.

When mounted between two contactors without additional width, the VM4 mechanical interlock unit prevents one of the contactors from closing as long as the other contactor is closed.

The mechanical interlock unit includes 2 fixing clips (BB4).

Ordering details

For contactors	Type	Order code	Pkg qty	Weight (1 pce)
AF09 ... AF38..-30-.. AF09 ... AF38..-40-00	VM4	1SBN030105T1000	10	0.005 kg

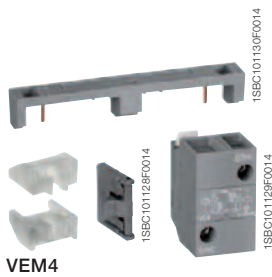

Mechanical and electrical interlock set

VEM4 mechanical and electrical interlock set for the interlocking of two AF contactors.

VEM4 set includes a mechanical interlock unit VM4 with 2 fixing clips (BB4) and a VE4 electrical interlock block with A2-A2 connection.

Fixing the electrical interlock block to the contactor front face connects the 2 built-in N.C. interlocking contacts with the two coils. VE4 block must be used with A2-A2 connection to respect the electrical connection diagram.

Ordering details

For contactors	Auxiliary contacts	Type	Order code	Pkg qty	Weight (1 pce)
AF09 ... AF16..-30-.. AF26 ... AF38..-30-00 AF09, AF16..-40-00 AF26, AF38..40-00	 1 1	VEM4	1SBN030111R1000	1	0.035 kg

Note: VEM4 not fittable on AF..Z contactors with DC control voltage 12...20 V DC.

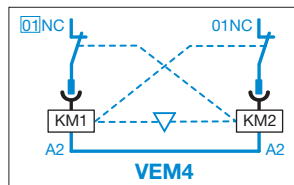

Fixing clips

For contactors	Type	Order code	Pkg qty	Weight (1 pce)
AF09 ... AF38	BB4	1SBN110120W1000	50	0.002 kg

Mechanical latching unit



1SBC66463F0001

WB75-A

Description

For converting standard contactors into latched contactors.

The WB75-A block contains a mechanical latching device with electromagnetic impulse unlatching (AC or DC) or manual unlatching.

Captive screw type connecting terminals, built-in cable clamps, M3.5 (+,-) pozidriv 2 screw with screw-driver guidance; delivered untightened and protected against accidental direct contact.

Operation

After closing, the contactor continues to be held in the closed position by the latching mechanism should the supply voltage fail at the contactor coil terminals.

Contactor opening can be controlled:

- electrically by an impulse* (AC or DC) on the WB75-A block coil.
 - * the coil is not designed to be permanently energized.
- manually by pressing the pushbutton on the front face of the WB75-A block.

Mounting

The WB75-A block is clipped onto the front face of the 1-stack contactor where it takes up two slots. The two other slots do not accept CA4 single pole auxiliary contacts. Up to 2 CAL4-11 auxiliary contact blocks can be side-mounted on contactors.

5

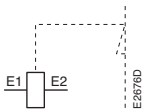

Terminal marking

Ordering details

For contactors	Rated control circuit voltage U_c		Type	Order code	Pkg qty	Weight (1 pce)
	V 50 Hz or DC	V 60 Hz				
AF09 ... AF38	24	24...28	WB75-A	FPTN372726R1001	1	0.120
	42	42...48	WB75-A	FPTN372726R1002	1	0.120
	48	48...55	WB75-A	FPTN372726R1003	1	0.120
	110	110...127	WB75-A	FPTN372726R1004	1	0.120
	220...230	220...255	WB75-A	FPTN372726R1006	1	0.120
	230...240	230...277	WB75-A	FPTN372726R1005	1	0.120
	380...415	380...440	WB75-A	FPTN372726R1007	1	0.120
	415...440	440...480	WB75-A	FPTN372726R1008	1	0.120

Note: For WB75-A produced since week 06-2012.

Connection accessories for starting solutions



BEA16-4

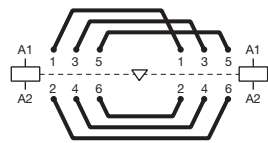

Connecting links with manual motor starters

The BEA...-4 connecting links are used to connect AF09 ... AF38 contactors with the MS116 or MS132 manual motor starters.

The BEA...-4 insulated 3-pole connecting links ensure the electrical and mechanical connection between the contactor and the associated manual motor starter.

Ordering details

For 3-pole contactors	Manual motor starter	Type	Order code	Pkg qty	Weight (1 pce) kg
AF09 ... AF16	MS116-0.16 ... MS116-25, MS132-0.16... MS132-25	BEA16-4	1SBN081306T1000	10	0.025
AF26 ... AF38	MS116-0.16 ... MS116-16, MS132-0.16 ... MS132-10	BEA26-4	1SBN082306T1000	10	0.025
	MS116-20 ... MS116-32, MS132-12 ... MS132-32	BEA38-4	1SBN082306T2000	10	0.030

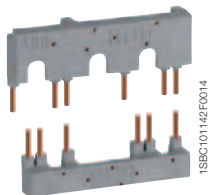

BER16-4

Connection sets for reversing contactors

BER16-4 and BER38-4 connection sets between the main poles of two 3-pole contactors mounted side by side.

The connection sets are made up of 1 upstream and 1 downstream connections: insulated, solid copper bars.

Ordering details

For 3-pole contactors	Type	Order code	Pkg qty	Weight (1 pce) kg
AF09 ... AF16	BER16-4	1SBN081311R1000	1	0.045
AF26 ... AF38	BER38-4	1SBN082311R1000	1	0.100

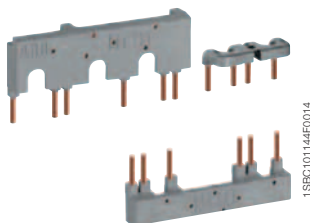
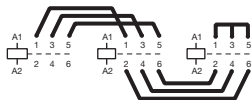

BEY16-4

Connection sets for star-delta starting

BEY16-4 and BEY38-4 connection sets between the main poles of the Line, Delta and Star contactors of a star-delta starter.

The connection sets are made up of:

- Line contactor / delta contactor: upstream phase-to-phase connection
- Delta contactor / star contactor: downstream connection in parallel
- Star contactor: star point upstream.

Ordering details

For 3-pole line, delta & star contactors	Interlock unit between delta & star contactors	Type	Order code	Pkg qty	Weight (1 pce) kg
AF09 ... AF16	With or without VM4 or VEM4	BEY16-4	1SBN081313R2000	1	0.050
AF26 ... AF38	With or without VM4 or VEM4	BEY38-4	1SBN082713R2000	1	0.110

Other accessories



LDC4

1SBC101133F0014

Ordering details

For contactors	Type	Order code	Pkg qty	Weight (1 pce) kg
----------------	------	------------	---------	-------------------

Additional coil terminal block

Additional coil terminal block for a bottom access to the coil terminals of contactors or contactor relays.

AF09 ... AF38, NF	LDC4	1SBN070156T1000	10	0.010
-------------------	------	-----------------	----	-------

Protective covers

Sealable and transparent protective covers BX4 and non-removable BX4-CA to protect the devices against accidental contact.

All 1-stack contactors and contactor relays	BX4	1SBN110108T1000	10	0.006
For 4-pole CA4 and 2-pole CAT4 auxiliary contact blocks	BX4-CA	1SBN110109W1000	50	0.001



BX4

1SBC101136F0014

5

Mounting piece

Mounting piece for replacement of A / AL26 ... A / AL40 contactors fixed by screws by AF contactors in 45 mm width.

AF09 ... AF38	BP38-4	1SBN112303T1000	10	0.003
---------------	--------	-----------------	----	-------

Function markers

Box of 16 blank cards (16 markers by card) printable on HTP500 thermal transfer printer and AMS 500 marking table to identify your contactors, overload relays or manual motor starters.

Marker dimensions: 7 x 20 mm (.276" x .787").

Box of 16 blank cards	BA4	1SNA235156R2700	16	0.011
AMS 500 support plate for 8 BA4	SPRC 1	1SNA360010R1500	1	0.220
HTP500 support plate	HTP500-BA4	1SNA235712R2400	1	0.290



BP38-4

1SBC101388F0014

Terminal connecting strips and shorting bars

Parallel and series connection of 3-pole contactor:

- To obtain a star point (3 parallel-connected poles)
- To connect poles in parallel and thus increase the AC load passing through the flow path made up of the parallel-connected poles
The relevant cable cross-sectional area may limit the maximum permissible current. Consult the information in the table below
- To connect poles in series and thus increase the DC load controlled by the poles: LY16-4 and LY38-4 secable strips.

Types	for connection of "n" poles	with terminal	insulated
LY...	n = 2 (secable LY16-4, LY38-4 connecting strips)	no	yes
	n = 3	no	yes



BA4

1SNC160101F0014



LY16-4

1SBC101144F0014

For contactors	max. nominal continuous current with "n" poles				Cable cross-sectional area mm ²	Type	Order code	Pkg qty	Weight (1 pce) kg
	in parallel		in series						
	2 poles	3 poles	4 poles	2 poles					
AF09	30	33	-	25	6	LY16-4	1SBN071303T1000	10	0.006
AF12	32	36	-	27					
AF16	34	40	-	30					
AF26	50	60	-	45	10	LY38-4	1SBN072303T1000	10	0.012

Main dimensions mm, inches

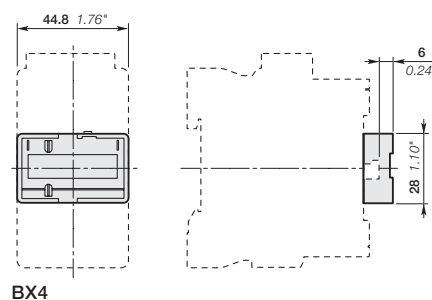

BX4

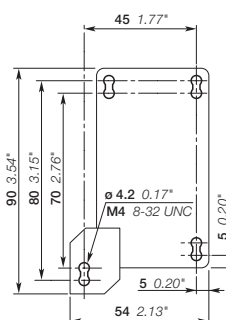

BP38-4

1SBC10156S0201

Accessories for A40 ... AF2050 contactors

Auxiliary contact blocks	5/122
Pneumatic timer blocks	5/123
Mechanical interlock units	5/124
Mechanical and electrical interlock units	5/124
Function markers - Mounting piece	5/125
Electronic timer for star-delta starters	5/126
Surge suppressors for contactor coils	5/127
Interface relays	5/128
Mechanical latching unit	5/129
Additional terminal blocks	5/130
Terminals for control lead connections	5/131
Terminal shrouds	5/132
Terminal enlargements - Terminal extensions	5/133
Connector terminals	5/134
Terminal connecting strips and shorting bars	5/135
Connecting links for contactors and manual motor starters	5/136
Connection bars for contactor and MCCB	5/137
Connection bars for contactor and switch fuse	5/138
Connection sets for reversing contactors	5/139
3-pole connections phase to phase	5/139
Connections for 4-pole changeover contactors	5/139
Connection sets for star-delta starter	5/140
Mounting plates for A95 ... AF750 contactors	5/141
Adapter plates for A95 ... AF750 contactors	5/142
Main contact sets - Arc chutes for 3-pole contactors	5/143
Contactor coils	5/144

Auxiliary contact blocks



CA5-10



CA5-40E



CAL5-11

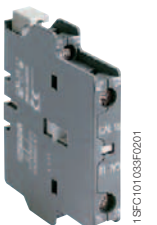

CAL18-11

Description

The auxiliary contact blocks are used for the operation of auxiliary circuits and control circuits for standard industrial environments.

Types of auxiliary contact blocks for front mounting:

- CA5 1 or 4-pole block, instantaneous with N.O., N.C. contacts
- CC5 1-pole block, with N.O. leading contact or N.C. lagging contact.

Select the 4-pole auxiliary contact blocks CA5-..E, CA5-..M or CA5-..U type, according to the contactor type for compliance with the standard requirements (see "Terminal Marking and Positioning").

Types of auxiliary contact blocks for side mounting:

- CAL... 2-pole block instantaneous N.O. + N.C. contacts.

For clipping onto the right and/or lefthand side of the contactors.

The CAL18-11B is a second block for mounting in addition to a first CAL18-11 block, right and/or lefthand of the A145 ... A300 and AF145 ... AF2050 contactors.

The auxiliary contact blocks are equipped with screw type connecting terminals delivered open, protected against accidental direct contact and bear the corresponding function marking.

Ordering details

For contactors	Number of blocks (1)	Auxiliary contacts	Type	Order code	Pkg qty	Weight (1 pce)
						kg

Front-mounted instantaneous auxiliary contact blocks, 1-pole

A40, AL40, TAL40	1-5	1 0 - -	CA5-10	1SBN010010R1010	10	0.014
A45 ... A110	1-6	0 1 - -	CA5-01	1SBN010010R1001	10	0.014
AF45, AF110	1-6	- - 1 0	CC5-10	1SBN010011R1010	10	0.014
AE45 ... AE75, TAE45 ... TAE75	1-6	- - 0 1	CC5-01	1SBN010011R1001	10	0.014

Front-mounted instantaneous auxiliary contact blocks, 4-pole

A45 ... A110	1	4 0 - -	CA5-40E	1SBN010040R1040	2	0.060
AE45 ... AE75	1	3 1 - -	CA5-31E	1SBN010040R1031	2	0.060
AF45 ... AF110	1	2 2 - -	CA5-22E	1SBN010040R1022	2	0.060
TAE45 ... TAE75	1	0 4 - -	CA5-04E	1SBN010040R1004	2	0.060
		1 1 1 1	CA5-11/11E	1SBN010040R1018	2	0.060
A40-30-10	1	3 1 - -	CA5-31M	1SBN010040R1131	2	0.060
AL40-30-10	1	2 2 - -	CA5-22M	1SBN010040R1122	2	0.060
TAL40-30-10	1	1 3 - -	CA5-13M	1SBN010040R1113	2	0.060
		0 4 - -	CA5-04M	1SBN010040R1104	2	0.060
		1 1 1 1	CA5-11/11M	1SBN010040R1118	2	0.060
A40-30-01	1	4 0 - -	CA5-40U	1SBN010040R1340	2	0.060
AL40-30-01	1	3 1 - -	CA5-31U	1SBN010040R1331	2	0.060
TAL40-30-01	1	2 2 - -	CA5-22U	1SBN010040R1322	2	0.060
		0 4 - -	CA5-04U	1SBN010040R1304	2	0.060

Side-mounted instantaneous auxiliary contact blocks, 2-pole

A40 ... A75	1-2	1 1 - -	CAL5-11	1SBN010020R1011	2	0.050
AL40, TAL40	1					
AE45 ... AE75, TAE45 ... TAE75	1					
AF45 ... AF75	1-2					
UA16 ... UA75	1-2					
A95 ... A300	1-2	1 1 - -	CAL18-11	1SBN010720R1011	2	0.050
AF95 ... AF2050	1-2					
UA95, UA110	1-2					
A145 ... A300	1-2(2)	1 1 - -	CAL18-11B	1SBN010720R3311	2	0.050
AF145 ... AF2050	1-2(2)					

(1) For each contactor type, refer to "Accessory fitting details" table.

(2) 2 blocks CAL18-11 + 2 blocks CAL18-11B.

Note:

- The front-mounted auxiliary contact blocks provided for the A... contactors can be used for the UA..., GA... and GAE... types
- The CAL... auxiliary contact blocks can be used for GA... contactors:
 - GA75-10-00: 2 x CAL5-11 blocks
 - GA75-10-11: 1 x CAL5-11 block
 - GAE75-10-00: 1 x CAL5-11 block
 - GAE75-10-11: no add-on block.
- The CAL... auxiliary contact blocks can be used for UA..RA contactors. See "Accessory fitting details" for this contactor type.

Pneumatic timer blocks

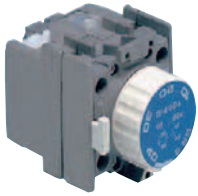

1SBC574883F0302

TP40DA

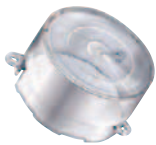

1SBC86832FC601

BX-TP

Description

The timer blocks are equipped with adjustable time delay auxiliary contacts.

Types

- TP40DA, TP180DA (blue button) for time delay on energization
- TP40IA, TP180IA (black button) for time delay on de-energization.

Pneumatic timer with 350° linear scale and setting via marked knurled knob.

Block equipped with 2 time-delayed auxiliary contacts: 1 N.O. and 1 N.C.

Captive screw type connecting terminals with built-in cable clamps. M3.5 (+,-) pozidriv 2 screw with screwdriver guidance, supplied untightened and protected against accidental direct contact.

Clipped onto the front panel of A40 ... A75 1-stack contactors.

Accessory

BX-TP plastic sealed cover protecting access to the time delay setting.

Ordering details (1)

For contactors	Time delay setting	Type	Order code	Pkg qty	Weight (1 pce) kg
----------------	--------------------	------	------------	---------	-------------------

Pneumatic timer blocks for time delay on energization

A40 ... A75	0.1...40 s	TP40DA	1SBN020300R1000	1	0.070
1-stack	10...180 s	TP180DA	1SBN020300R1001	1	0.070

Pneumatic timer blocks for time delay on de-energization

A40 ... A75	0.1...40 s	TP40IA	1SBN020301R1000	1	0.070
1-stack	10...180 s	TP180IA	1SBN020301R1001	1	0.070

Accessory

-	BX-TP	FPTN472657R0001	1	0.006
---	-------	-----------------	---	-------

Note: The TP... timers provided for A40 ... A75 contactors can be used for the AF, AE, TAE, UA, GA and GAE contactors.

(1) For each contactor type, refer to "Accessory fitting details" table.

Mechanical interlock units

Mechanical and electrical interlock units

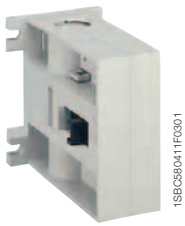

VM300H

Description

When mounted between two contactors, the mechanical interlock unit prevents one of the contactors from closing as long as the other contactor is closed.

- VM... interlock units for mechanical interlocking of two horizontal or vertical mounted AC or DC operated contactors
- VE... interlock units for mechanical and electrical interlocking of two horizontal mounted AC or DC operated contactors.

Ordering details (1)

Left side contactor	Right side contactor	Mounting	Type	Order code	Pkg qty	Weight (1 pce) kg
---------------------	----------------------	----------	------	------------	---------	-------------------

Mechanical interlock units for two horizontal mounted contactors (1)

A40	A40	Rail mounting	VM5-1	1SBN030100R1000	1	0.066
A40	A45 ... A110	See table below with VE5-.. type	–	–	–	–
A45 ... A75	A45 ... A110	–	–	–	–	–
A95 ... A185	A45 ... A110	–	–	–	–	–
A95 ... A185	A145 ... A300	PN.. mounting plate to be ordered separately	VM300H	1SFN034700R1000	1	0.150
A210 ... A300	A145 ... A300	–	VM300H	1SFN034700R1000	1	0.150
A210 ... A300	AF400 ... AF460	–	VM300/460H	1SFN035100R1000	1	0.150
AF400 ... AF1250	AF400 ... AF1250	–	VM750H	1SFN035700R1000	1	0.200
AF1350 ... AF2050	AF1350 ... AF2050	Plate included	VM1650H	1SFN036503R1000	1	6.000

(1) Mechanical durability: VM5-1 = 5 millions cycles, VM300H ... VM750H = 1 million cycles.

The interlock units provided for A... contactors can be used for AF types.

The interlock units provided for A40.. contactors can be used for AL40.. and TAL40.. types.

Up contactor	Down contactor	Mounting	Type	Order code	Pkg qty	Weight (1 pce) kg
--------------	----------------	----------	------	------------	---------	-------------------

Mechanical interlock units for two vertical mounted contactors (2)

A95 ... A185	A145 ... A300	Additional plate (not supplied)	VM300V	1SFN034701R1000	1	0.150
A210 ... A300	A145 ... A300	–	VM300V	1SFN034701R1000	1	0.150
A210 ... A300	AF400 ... AF460	–	VM300/460V	1SFN035101R1000	1	0.150
AF400 ... AF1250	AF400 ... AF1250	–	VM750V	1SFN035701R1000	1	0.200

(2) Mechanical durability: VM300V ... VM750V = 1 million cycles.

Left side contactor	Right side contactor	Mounting	Type	Order code	Pkg qty	Weight (1 pce) kg
---------------------	----------------------	----------	------	------------	---------	-------------------

Mechanical and electrical interlock units for two horizontal mounted contactors

A40	A40	Rail mounting	VE5-1	1SBN030110R1000	1	0.076
A40 ... A75	A45 ... A75	–	VE5-2	1SBN030210R1000	1	0.146
A45 ... A75	A40 ... A75	–	VE5-2	1SBN030210R1000	1	0.146
A45 ... A75	A95 ... A110	PN.. mounting plate to be ordered separately	VE5-2 (3)	1SBN030210R1000	1	0.146
A95 ... A110	A45 ... A75	–	VE5-2 (3)	1SBN030210R1000	1	0.146
A95 ... A110	A95 ... A110	–	VE5-2	1SBN030210R1000	1	0.146

(3) The combination of A45 ... A75 contactors interlocked with A95, A110 contactors cannot be mounted on symmetrical rail (75 mm, IEC/EN 60715).

The interlock units provided for A... contactors can be used for AE, TAE, AF, GA and GAE types.

The interlock units provided for A40.. contactors can be used for AL40.. and TAL40.. types.

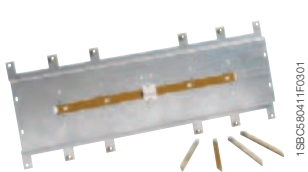

VM1650H

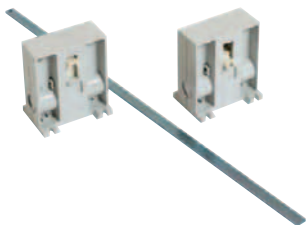

VM300V



VE5-1

Function markers

Mounting piece



BA5-50

1SBC575874FC001

BA5-50 Function markers

Description

For marking contactors, thermal overload relays and accessories.

The BA5-50 is a set of 50 function markers designed to be clipped onto the front face of devices.

Effective marking surface: 7 x 19 mm.

Details can be added to these markers using a ball point pen, indelible felt-tip pen or pentel white.

Self-adhesive labels (not supplied) can also be added to them.

Ordering details

For contactors	Type	Order code	Pkg qty	Weight (1 pce) kg
Contactors, thermal overload relays and accessories	BA5-50	1SBN110000R1000	1	0.017



BP16

1SBC586724FO002

BP16 Mounting piece

Description

Mounting piece for screw fixing (M4, not supplied) of UA, UA..RA series contactors indicated in the table below.

Easy handling of screwdrivers and screw driving.

Add-on mounting piece on contactor's rear face, offering a wide fixing facility.

Ordering details

For contactors	Type	Order code	Pkg qty	Weight (1 pce) kg
UA16, UA16..RA	BP16	1SBN111403R1000	100	0.141

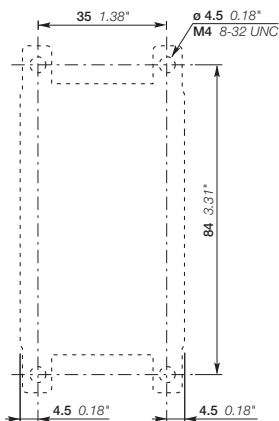

Drilling plan for UA16, UA16..RA contactors with BP16

Electronic timer for star-delta starters



TE5S...

5

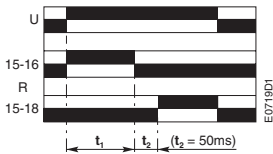

Chart

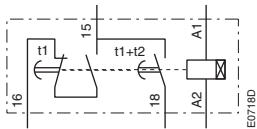

Equivalent diagram

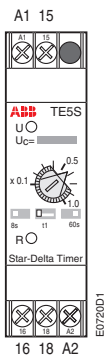

Front face

Description

When used in star-delta starters, the TE5S lags the star connection and provides a lapse of 50 ms before the switch over to delta connection.

According to the type of device chosen, the electronic circuit has a 24 V AC / DC, 110 to 120 V AC, 220 to 240 V AC or 380 to 440 V AC supply. An output relay with reversing contact ensures high current switching. A two-position switch allows selection of one of the two time delay ranges: 0.8 to 8 s or 6 to 60 s. The 0.1 to 1.0 graduated button allows an initial setting without steps within the previously selected range which can then be adjusted using a chronometer.

Note: We recommend that you allow for temperature drift for the final adjustment of the time delay setting. Drift: -0.2 % per °C.

For example, a setting made at 20 °C will yield a time delay shorter by 7 % at 55 °C in a cubicle (-0.2 % per °C i.e. $-0.2 \times 35 = -7 \%$).

Regardless of these settings the TE5S provides a fixed "lapse" of 50 ms between the opening of contact 15-16 and the closing of contact 15-18. This time delay prevents from arc short-circuit during star to delta switching.

Operation

On energization, the green U indicator light (voltage applied) comes on. Contact 15-16 then immediately moves to the closed position.

Count-down of the programmed time immediately commences. When the time delay has elapsed, contact 15-16 opens and at the same time the 50 ms lapse, t_2 , begins after which contact 15-18 moves to the closed position. The yellow R indicator light comes on.

On de-energization, the U and R indicator lights go out and, after the 250 ms resetting time, the device is ready for a new cycle.

Mounting

On 35 x 7.5 mm or 35 x 15 mm mounting rail according to IEC/EN 60715.

Ordering details

For contactors	Rated control circuit voltage		Type	Order code	Pkg qty	Weight (1 pce)
	V 50/60 Hz	V DC				
A40 ... A300	24	24	TE5S-24	1SBN020010R1001	1	0.080
	110...120	-	TE5S-120	1SBN020010R1002	1	0.080
	220...240	-	TE5S-240	1SBN020010R1003	1	0.080
	380...440	-	TE5S-440	1SBN020010R1004	1	0.080

Main dimensions mm, inches

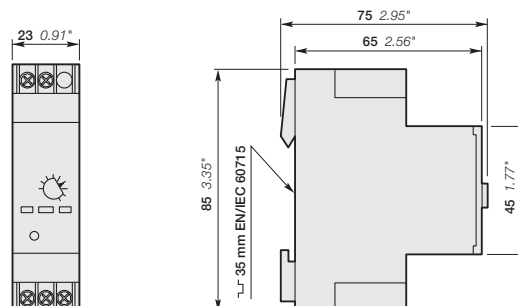

Surge suppressors for contactor coils

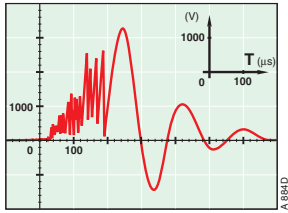

Description

The operation of inductive circuits causes overvoltages, in particular on opening of the contactor coil. The electromagnetic energy stored in the coil during contactor closing is restored on opening in the form of surges, the slope and amplitude of which may rise to several kilovolts. A number of drawbacks are observed ranging from interference on the electronic devices to breakdown of insulators and even destruction of certain sensitive components. The graph opposite reproduces the oscillogram showing voltage discharges at the terminals of a 42 V / 50 Hz coil without peak clipping. The coil was switched by 8 series-connected poles of a contactor relay. Following a burst of discharges with a very steep slope a damped oscillation emerges with a peak value of 3500 V.

Overvoltage Factor

The overvoltage factor k is defined as the ratio of the maximum overvoltage peak value \hat{U}_s to the peak value \hat{U}_c of the coil rated control voltage U_c :

$$k = \frac{\hat{U}_s \text{ max.}}{\hat{U}_c} \quad \text{in DC: } k = \frac{\hat{U}_s \text{ max.}}{U_c} \quad \text{or in AC: } k = \frac{\hat{U}_s \text{ max.}}{U_c \sqrt{2}}$$

For example the following is obtained for the above graph: $k = \frac{3500}{42 \sqrt{2}} \approx 60$

To reduce the harmful effects of these overvoltages, ABB has developed a range of surge suppressors designed to reduce the k factor defined above and to limit or even completely eliminate the high pre-damping voltage frequencies.

Each case is different, but the technical data tolerances and the generous sizing of parts have enabled us to reduce the number of variants.

We have chosen the following solutions: transil diodes, varistors and RC blocks.

Note: A varistor is a resistor whose value decreases to a very large extent when a certain voltage is applied at its terminals.



RV5/50

1SBC574001FC001



RC5-1/50

1SBC573891FC001

Ordering details

For contactors	Rated control circuit voltage U_c		Type	Order code	Pkg qty	Weight (1 pce) kg
	V	AC DC				
A40 ... A110, AL40, AE45 ... AE75, TAL40, TAE45 ... TAE75	24...50	● ●	RV5/50	1SBN050010R1000	2	0.015
	50...133	● ●	RV5/133	1SBN050010R1001	2	0.015
	110...250	● ●	RV5/250	1SBN050010R1002	2	0.015
	250...440	● ●	RV5/440	1SBN050010R1003	2	0.015
A40	24...50	● -	RC5-1/50	1SBN050100R1000	2	0.012
	50...133	● -	RC5-1/133	1SBN050100R1001	2	0.012
	110...250	● -	RC5-1/250	1SBN050100R1002	2	0.012
	250...440	● -	RC5-1/440	1SBN050100R1003	2	0.012
A45 ... A110	24...50	● -	RC5-2/50	1SBN050200R1000	2	0.015
	50...133	● -	RC5-2/133	1SBN050200R1001	2	0.015
	110...250	● -	RC5-2/250	1SBN050200R1002	2	0.015
	250...440	● -	RC5-2/440	1SBN050200R1003	2	0.015
A145 ... A300	250...440	● -	RC5-3/440	1SBN050300R1003	2	0.028
AL40, AE45 ... AE75, TAL40, TAE45 ... TAE75	12...32	- ●	RT5/32	1SBN050020R1000	2	0.015
	25...65	- ●	RT5/65	1SBN050020R1001	2	0.015
	50...90	- ●	RT5/90	1SBN050020R1002	2	0.015
	77...150	- ●	RT5/150	1SBN050020R1003	2	0.015
	150...264	- ●	RT5/264	1SBN050020R1004	2	0.015

Note: The surge suppressors provided for A... contactors can be used for the UA, UA..RA and GA75 types. The surge suppressors provided for AE45 ... AE75 contactors can be used for the GAE75 types.

Interface relays



RA5-1

Description

RA5-1 interface relay is designed to receive 24 V DC signals delivered by PLC's or other sources with a low output power and to restore them with sufficient power to operate the coils of the relevant A40 ... A110 contactors.

RA5-1 interface relay is made up of a miniature electromechanical relay equipped with a N.O. contact and with a low consumption 24 V DC coil.

The interface relay coil is controlled by the PLC while the N.O. contact ensures switching of the power contactor.

Coil switching gives rise to overvoltages which have adverse effects on the electronic devices, insulators and, more generally, on component lifetime. The RA5-1 is equipped with surge suppressors:

- on the 24 V DC relay coil via a diode,
- on the power contactor coil via a varistor.

Furthermore, the RA5-1 is protected against relay pole reversal by a diode inserted between the E1 and E2 input terminals.

Ordering details

For contactors	Coil voltages	Rated control circuit voltage Uc	Type	Order code	Pkg qty	Weight (1 pce)
	V 50/60 Hz	V DC				kg
A40 ... A110	24...250	24	RA5-1	1SBN060300R1000	1	0.050
			RA5-1	1SBN060300T1000	10	0.050

Note: The interface relays provided for the A... contactors can be used for the UA, UA..RA and GA types.

Mechanical latching unit



1SBC565483F0001

WB75-A

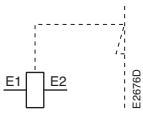

Terminal marking

Description

For converting standard contactors into latched contactors.

The WB75-A block contains a mechanical latching device with electromagnetic impulse unlatching (AC or DC) or manual unlatching.

Captive screw type connecting terminals, built-in cable clamps, M3.5 (+, -) pozidriv 2 screw with screw-driver guidance; delivered untightened and protected against accidental direct contact.

Operation

After closing, the contactor continues to be held in the closed position by the latching mechanism should the supply voltage fail at the contactor coil terminals.

Contactor opening can be controlled:

- electrically by an impulse* (AC or DC) on the WB75-A block coil.
 - * the coil is not designed to be permanently energized.
- manually by pressing the pushbutton on the front face of the WB75-A block.

Mounting

The WB75-A block is clipped onto the front face of the 1-stack contactor where it takes up two slots. The two other slots may accept CA5... single pole auxiliary contacts (1 block on each side of the mechanical latch).

Ordering details

For contactors	Rated control circuit voltage U_c		Type	Order code	Pkg qty	Weight (1 pce)
	V 50 Hz or DC	V 60 Hz				
A40 ... A75,	24	24...28	WB75-A	FPTN372726R1001	1	0.120
AF45 ... AF75,	42	42...48	WB75-A	FPTN372726R1002	1	0.120
AL40,	48	48...55	WB75-A	FPTN372726R1003	1	0.120
AE45 ... AE75,	110	110...127	WB75-A	FPTN372726R1004	1	0.120
TAL40,	220...230	220...255	WB75-A	FPTN372726R1006	1	0.120
TAE45 ... TAE75,	230...240	230...277	WB75-A	FPTN372726R1005	1	0.120
UA16 ... UA75,	380...415	380...440	WB75-A	FPTN372726R1007	1	0.120
GA75, GAE75	415...440	440...480	WB75-A	FPTN372726R1008	1	0.120

Additional terminal blocks



LD40

1SBC58373F0301



LD75

1SBC580742F0301



LD110

1SBC580729F0301

Description

The LD... terminal block is designed to increase the connecting capacity of the contactor on which it is fitted and for preparation of the wiring before final connection on the contactor.

The LD... blocks are 3-pole terminal blocks with tunnel terminals. The available range can be used on A40 to A110 contactors.

The LD75 and LD110 terminal blocks are fixed in the 3 independent slots located above the built-in connectors.

Ordering details

For contactors	Type	Order code	Pkg qty	Weight (1 pce) kg
A40	LD40	1SBN072808R1000	1	0.075
A45, A75	LD75	1SBN073508R1000	1	0.115
A95, A110	LD110	1SFN074308R1000	1	0.150

Note: The LD... terminal blocks provided for the A... contactors can be used for the AF, AL, AE, TAL, TAE and UA types.

Technical data

Types	LD40	LD75	LD110
Rated insulation voltage U_i			
acc. to IEC 60947-4-1	690 V		
acc. to UL / CSA	600 V		
Main terminals			
	Screw terminals with single connector 8x10 mm	Screw terminals with single connector 10x11 mm	Screw terminals with single connector 12x12 mm
Connection capacity (min. ... max.)			
Rigid	Solid ($\leq 4 \text{ mm}^2$)	6...50 mm ²	10...70 mm ²
Stranded ($\geq 6 \text{ mm}^2$)	4...16 mm ²	6...25 mm ²	10...35 mm ²
Flexible with ferrule	4...25 mm ²	6...35 mm ²	10...50 mm ²
Bars	8 mm	10 mm	12 mm
Tightening torque	2.5 Nm	4 Nm	6 Nm
Degree of protection	IP10		
acc. to IEC 60947-1 / EN 60947-1 and IEC 60529 / EN 60529			
Screw terminals	Delivered in closed position		
	M5	M6	M8
Screwdriver type	pozidriv 2		Hexagon socket (s = 4 mm)

Note: The utilization of LD... additional terminal blocks keeps the possibility to connect the following cables directly in the contactor main terminals but the BED and BEM connecting sets can no longer be used.

	LD40	LD75	LD110
Possible cross section of rigid cable in the contactor terminals	10 mm ²	50 mm ²	95 mm ²

Terminals for control lead connections



LK75-L



LK75-F

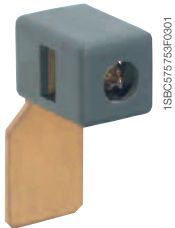

LK110

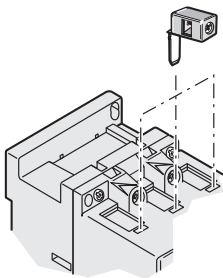

LK... positioning

Description

Terminals designed to connect the control conductors to the main poles of the A45 ... A110 contactors and derivative versions.

Accessories clipped into the slots placed above each power terminal connector.

The LK75... are fitted with a pin designed to hold them in place until the connector has been fully clamped with its power cable.

The LK110 must be held in place until the connector has been clamped.

- Degree of protection IP20
- Connecting terminal delivered in open position: cable clamp and M3.5 (+,-) pozidriv 2 screw.
- Cable cross-sectional area:
 - 1 or 2 rigid conductors..... 1...4 mm²
 - 1 or 2 flexible conductors with cable end 0.75...2.5 mm²
- Tightening torque for the LK... screw:
 - recommended 1.00 Nm
 - maxi..... 1.20 Nm

Ordering details

For contactors	Type	Order code	Pkg qty	Weight (1 pce) kg
Right and left on A45 ... A75	LK75-L	1SBN073552R1003	2	0.006
Opposite on A45 ... A75	LK75-F	1SBN073552R1002	2	0.006
Right and left on A95 ... A110	LK110	1SFN074352R1000	2	0.010

Note: The LK... terminals provided for the A... contactors can be used for the AF, AE, AM, TAE, UA, GA and GAE types.

Main dimensions mm, inches

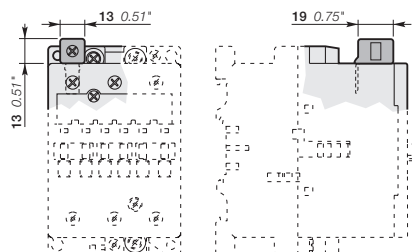

LK75-L, LK110

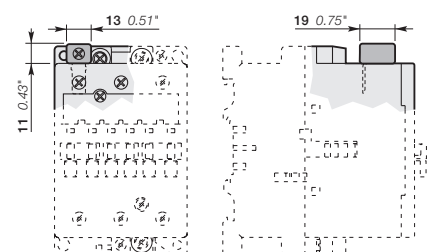

LK75-F

Terminal shrouds



LT...-AC

Description

Main terminal protection for A145 ... AF750 contactors.

The auxiliary contact blocks and coils are designed to provide an IP20 degree of protection.

The main terminals, equipped with lugs or connectors, can be protected against accidental direct contact after wiring (EN 50274) by the addition of terminal shrouds (see table below).

Ordering details

For contactors	Type	Order code	Pkg qty	Weight (1 pce) kg
A145 ... A185 with connectors	LT185-AC	1SFN124701R1000	2	0.050
A145 ... A185 with lugs	LT185-AL	1SFN124703R1000	2	0.220
A145 ... A185 with short. bar LY185 or between A145 and TA200DU or between A185 and TA200DU	LT185-AY	1SFN124704R1000	1	0.050
A210 ... A300 with connectors	LT300-AC	1SFN125101R1000	2	0.070
A210 ... A300 with lugs	LT300-AL	1SFN125103R1000	2	0.280
A210 ... A300 with short. bar LY300	LT300-AY	1SFN125104R1000	1	0.075
AF400 ... AF460 with connectors	LT460-AC	1SFN125701R1000	2	0.100
AF400 ... AF460 with lugs	LT460-AL	1SFN125703R1000	2	0.800
AF580 ... AF750 with connectors	LT750-AC	1SFN126101R1000	2	0.120
AF580 ... AF1250 with lugs	LT750-AL	1SFN126103R1000	2	0.825

Note: The shrouds provided for the A... contactors can be used for the AF... types.

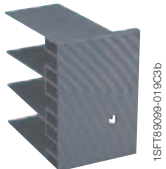

LT...-AL



LT...-AY

Terminal enlargements

Terminal extensions



1SFT9600-011C3

LW...

LW... Terminal enlargements

Description

Enlargement pieces designed to increase the width of the contactor terminal pads in order to allow larger connections to be mounted.

Sets containing 3 tin plated copper bars fixed by an isolating spacer.

Ordering details

For contactors	Dimensions		Type	Order code	Pkg qty	Weight (1 pce)
	hole Ø mm	bar mm				
A95, A110	6.5	15 x 3	LW110	1SFN074307R1000	1	0.100
A145, A185	10.5	20 x 5	LW185	1SFN074707R1000	1	0.250
A210 ... A300	10.5	25 x 5	LW300	1SFN075107R1000	1	0.450
AF400, AF460	10.5	25 x 5	LW460	1SFN075707R1000	1	0.730
AF580, AF750	13	40 x 6	LW750	1SFN076107R1000	1	1.230
AF1250	13	50 x 10	LW1250	1SFN076407R1000	1	2.000

Note: The LW... pieces provided for the A... contactors can be used for the AF, AE, TAE and UA types.

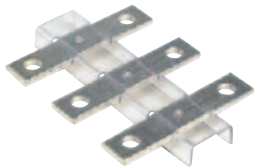

1SFT9600-012C3

LX...

LX... Terminal extension

Description

Extension pieces designed to extend the main terminals of contactors for combined mounting of contactors and connection sets.

Sets containing 3 tin plated copper bars fixed by an isolating spacer.

Ordering details

For contactors	Dimensions		Type	Order code	Pkg qty	Weight (1 pce)
	hole Ø mm	bar mm				
A145, A185	8.5	20 x 5	LX185	1SFN074710R1000	1	0.250
A210 ... A300	10.5	20 x 5	LX300	1SFN075110R1000	1	0.350
AF400, AF460	10.5	25 x 5	LX460	1SFN075710R1000	1	0.500
AF580, AF750	13	40 x 6	LX750	1SFN076110R1000	1	0.850

Note: The LX... pieces provided for the A... contactors can be used for the AF types.

Connector terminals



1SFT98099-011C1

LZ...



1SFT98099-095C2

LZ...



1SBC380642FC02

LZ...

Description

Connection of copper and aluminium cables to the terminal pads of the poles of A and AF contactors.

Ordering details

Cables	For contactors	Cable cross section mm ²	Type	Order code	Pkg	Weight
					qty	(1 pce)
						kg
Single Cu	A145, A185	6...185	-	1SDA023354R0001	3	0.200
	A210 ... A300	16...240	-	1SDA023368R0001	3	0.400
Single Al & Cu	A145, A185	35...95	-	1SDA023356R0001	3	0.100
	A145, A185	25...150	-	1SDA023357R0001	3	0.100
	A210 ... A300	120...240	-	1SDA023370R0001	3	0.200
Double Cu	A145, A185	2 x (50...120)	LZ185-2G/120	1SFN074709R1000	3	0.300
Double	A210 ... A300	2 x (95...120)	-	1SDA025766R0001	3	0.400
Al & Cu	AF400 ... AF750	2 x (120...240)	-	1SDA023380R0001	3	0.110
Triple Al & Cu	AF400 ... AF750	3 x (70...185)	-	1SDA023384R0001	3	0.265
Multi Al & Cu	AF1350, AF1650	4 x (120...240)	-	1SDA023387R0001	3	0.400

Note: Connectors provided for the A... contactors can be used for the AF types.

Terminal connecting strips and shorting bars



LP185

1SFT198000-010C3



LY185

1SFT198000-015C3



LH...

SB7170C3_1



LF...

SB7170C3_2

Description

Parallel and series connection of 3-pole and 4-pole contactor poles:

- To obtain a star point (3 parallel-connected poles): LY, LF, (LY allows 3 phases to be short-circuited).
- To connect poles in parallel and thus increase the AC load passing through the flow path made up of the parallel-connected poles: LP and LH (2 poles); LY and LF (3 poles) ; LG (4 poles).

For the maximum permissible current values with parallel-connected poles see "Parallel connection of main poles".

The relevant cable cross-sectional area may limit the maximum permissible current. Consult the information in the table below.

- To connect poles in series and thus increase the DC load controlled by the poles: LP and LH.

Types	for connection of "n" poles	with terminal	insulated
LP...	n = 2	no	yes (1)
LY...	n = 3	no	yes (1)
LH...	n = 2	yes	no
LF...	n = 3	yes	no

(1) LP460 ... LP750, LY185 ... LY750 not insulated. Use terminal shrouds.

Ordering details

For contactors	max. nominal continuous current with "n" poles A	Cable cross-sectional area mm ²	Type	Order code	Pkg qty	Weight (1 pce) kg
A145, A185	300	-	LP185	1SFN074712R1000	2	0.300
A210 ... A300	475	-	LP300	1SFN075112R1000	2	0.400
AF400, AF460	725	-	LP460	1SFN075712R1000	4	0.550
AF580, AF750	1200	-	LP750	1SFN076112R1000	4	0.950
A95, A110	240	-	LY110	1SFN074303R1000	1	0.055
A145, A185	400	-	LY185	1SFN074703R1000	1	0.200
A210 ... A300	670	-	LY300	1SFN075103R1000	1	0.300
AF400, AF460	1000	-	LY460	1SFN075703R1000	1	0.450
AF580, AF750	1650	-	LY750	1SFN076103R1000	1	0.800
A45 ... A75	200	95	LH75	FPTN472734R0001	2	0.085
A40	140	50	LF40	1SBN073205R1000	2	0.037
A45 ... A75	275	150	LF75	FPTN472735R0001	2	0.095

Note: The strips and shorting bars provided for the A... contactors can be used for the AF, AL, AL..Z, AE, TAL and TAE types.

Connecting links for contactors and manual motor starters

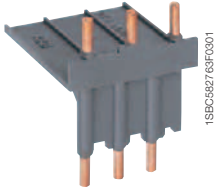

BEA40/450

Description

The BEA... connecting links are used to connect a contactor to associated manual motor starters. These are then used together as DOL or reversing starters in type 1 or type 2 coordination, complying with IEC 60947-4-1 and EN 60947-4-1.

The BEA... insulated 3-pole connecting link (touch safe) ensures the electrical linking between the contactor and the corresponding manual motor starter.

Selection table

le max. AC-3 400 V A	Contactor & fixing screws not supplied	Connecting link	MMS & fixing screws not supplied	Connection set for the contactors	Interlock unit (see "Accessory fitting details")
Direct-on-line starter					
37	A40 2xM4	BEA40/450	MS450 2xM5	-	-
50	A50 2xM4	BEA50/450	MS450 2xM5	-	-
50	A50 2xM6	BEA75/495	MS495 2xM5	-	-
63	A63 2xM6	BEA75/495	MS495 2xM5	-	-
75	A75 2xM6	BEA75/495	MS495 2xM5	-	-
90	A95 2xM6	BEA110/495	MS495 2xM5	-	-
100	A110 2xM6	BEA110/495	MS495 2xM5	-	-
Reversing starter					
37	2xA40 4xM4	BEA40/450	MS450 2xM5	BER40V	VM5-1 / VE5-1
50	2xA50 4xM4	BEA50/450	MS450 2xM5	BEM75-30	VE5-2
50	2xA50 4xM6	BEA75/495	MS495 2xM5	BEM75-30	VE5-2
63	2xA63 4xM6	BEA75/495	MS495 2xM5	BEM75-30	VE5-2
75	2xA75 4xM6	BEA75/495	MS495 2xM5	BEM75-30	VE5-2
90	2xA95 4xM6	BEA110/495	MS495 2xM5	BEM110-30	VE5-2
100	2xA110 4xM6	BEA110/495	MS495 2xM5	BEM110-30	VE5-2

Ordering details

For contactors	Manual motor starter	Type	Order code	Pkg qty	Weight (1 pce) kg
A40	MS450	BEA40/450	1SBN083206R1000	1	0.061
A50	MS450	BEA50/450	1SBN083506R1000	1	0.062
A50, A63, A75	MS495	BEA75/495	1SBN084106R1000	1	0.120
A95, A110	MS495	BEA110/495	1SBN084506R1000	1	0.124

The BEA... connecting links provided for the A... contactors can be used for the AF..., AE..., and TAE... types.

Connection bars for contactor and MCCB



BEA300

1SFT98001-065C3

Description

Connection between contactors/ starters and moulded case circuit breakers. These connection sets are solid copper bars.

Ordering details

For contactors	MCCB	Type	Order code	Pkg qty	Weight (1 pce)
					kg



BEA...D

1SFT98001-070C3

Vertical assembly

A145, A185, AF145, AF185	T3	BEA185/T3	1SFN084706R1003	1	0.150
A145, A185, AF145, AF185	T4	BEA185/T4	1SFN084706R1005	1	0.150
A210, AF210	T4	BEA210/T4	1SFN085106R1003	1	0.160
A210 ... A300, AF210 ... AF300	T5	BEA300/T5	1SFN085106R1004	1	0.200
AF400 ... AF750	T6	BEA750/T6	1SFN086106R1000	1	0.410
AF400 ... AF750	T5	BEA750/T5	1SFN086106R1001	1	0.410

Vertical assembly with control wire terminals (also suitable when using busbar kits for starter combinations)

A145, A185, AF145, AF185	T3	BEA185D/T3	1SFN084706R1004	1	0.175
A145, A185, AF145, AF185	T4	BEA185D/T4	1SFN084706R1006	1	0.175
A210, AF210	T4	BEA210D/T4	1SFN085106R1005	1	0.270
A210 ... A300, AF210 ... AF300	T5	BEA300D/T5	1SFN085506R1003	1	0.320
AF400 ... AF750	T6	BEA750D/T6	1SFN086106R1002	1	0.720
AF400 ... AF750	T5	BEA750D/T5	1SFN086106R1003	1	0.720

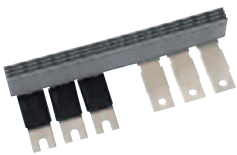

BEA300H

1SFC101001F0201C3

Horizontal assembly (also suitable when using busbar kits for starter combinations)

A210 ... A300, AF210 ... AF300	T5	BEA300H/T5	1SFN085307R1002	1	1.280
AF400, AF460	T4	BEA460H/T4	1SFN085907R1000	1	2.450

Connection bars for contactor and switch fuse



1SF198001-006C3

BEF300/OESA400

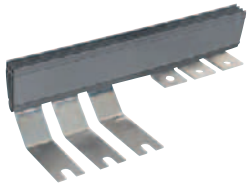

1SF198001-006C3

BEF300H/OESA400

Description

Connection between contactors/starters and switch fuse. These connection sets are solid copper bars.

Ordering details

For contactors	Switch fuse	Type	Order code	Pkg qty	Weight (1 pce)
					kg

Vertical assembly

A185	OESA250	BEF185/OESA250	1SFN084908R1000	1	0.260
A210 ... A300	OESA250 to OESA400	BEF300/OESA400	1SFN085108R1000	1	0.330
A145	OS160	OSZA15	1SCA022509R0120	1	0.170
AF400, AF460	OESA400	BEF460/OESA400	1SFN085708R1000	1	0.340
AF460 ... AF750	OESA630 to OESA800	BEF750/OESA800	1SFN086108R1000	1	0.740

Horizontal assembly

A145	OS160...LR	OSZA15	1SCA022509R0120	1	0.170
A145, A185	OESA250...LR	BEF185H/OESA250	1SFN084709R1000	1	0.550
A210 ... A300	OESA250...LR to OESA400...LR	BEF300H/OESA400	1SFN085109R1000	1	1.200
AF400, AF460	OESA400...LR	OESA460H/OESA400	1SFN085709R1000	1	1.250

Note: The BEF... connection bars provided for the A145 ... A300 contactors can be used for the AF145 ... AF300 contactors.

Connection sets

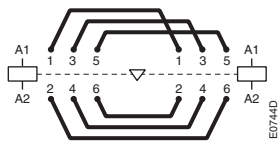

BEM... connections

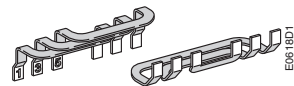

BEM75-30



BEM300-30

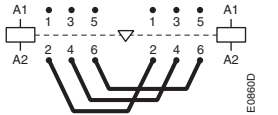

BES... for 3-pole connections

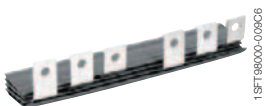

BES...

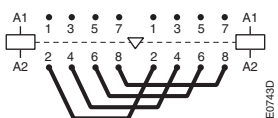

BES... for 4 N.O. main pole connections

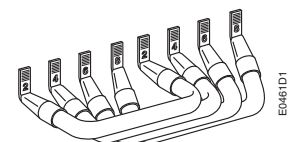

BES75-40

Connection sets for reversing contactors

Description

Connections between the main poles of two 3-pole contactors mounted side by side as reversing contactors. The sets are made up of three upstream connections and three downstream connections.

- BER40V – Insulated, stranded, rigid copper wires
- BEM75-30 ... BEM750-30 – Insulated, solid copper bars

On the A... contactors, the power supply by bars or cables equipped with lugs is directly connected to the terminal pads of the main poles. For flange connectors, LX... terminal extension pieces should be used.

Ordering details

For 3-pole contactors	Type	Order code	Pkg qty	Weight (1 pce) kg
A40	BER40V	1SBN082411R1000	1	0.085
A50 ... A75	BEM75-30	1SBN083501R1000	1	0.243
A95, A110	BEM110-30	1SFN084301R1000	1	0.450
A145, A185	BEM185-30	1SFN084701R1000	1	0.900
A210 ... A300	BEM300-30	1SFN085101R1000	1	1.100
AF400, AF460	BEM460-30	1SFN085701R1000	1	4.400
AF580, AF750	BEM750-30	1SFN086101R1000	1	7.300

Note: The connections provided for the A... contactors can be used for the AF, AL, TAL, AE and TAE types.

3-pole connections phase to phase

Description

Connections between the main poles of two 3-pole contactors horizontal mounted. This set is made up of three downstream or upstream connections.

Ordering details

For 3-pole contactors	Type	Order code	Pkg qty	Weight (1 pce) kg
A50 ... A75	BES75-30	1SBN083504R1000	1	0.130
A95, A110	BES110	1SFN084304R1000	1	0.250
A145, A185	BES185	1SFN084704R1000	1	0.500
A210 ... A300	BES300	1SFN085104R1000	1	1.000
AF400, AF460	BES460	1SFN085704R1000	1	2.200
AF580, AF750	BES750	1SFN086104R1000	1	3.700

Note: The connections provided for the A... contactors can be used for the AF, AE and TAE types.

Connections for 4-pole changeover contactors

Description

Connection between the main poles of two 4-pole contactors mounted side by side so that they operate as source reversing contactors.

These sets are made up of four downstream connections, with insulated, stranded, rigid copper cables.

Ordering details

For 4-pole contactors	Type	Order code	Pkg qty	Weight (1 pce) kg
A45, A50, A75	BES75-40	1SBN083302R1000	1	0.400

Note: The connections provided for the A... contactors can be used for the AF, AE and TAE types.

Connection sets for star-delta starter

Description

Connections between the main poles of a star-delta starter.

These sets are made up of:

- Three line contactor / delta contactor connections - Upstream side
- Three connections for star and delta contactors - Downstream side
- The necessary elements to create the star point upstream of the star contactor.

BED50 / BED50-1, BED75 / BED75-1 – Solid copper bars and insulated stranded copper wires.

BED95 ... BED750 – Insulated, solid copper bars.

BED50-1 ... BED75-1 connection sets are designed for star and delta contactors without mechanical interlock unit (contactors mounting joined side by side).

For mechanically interlocked star and delta contactors use BED50 ... BED75 connection sets.

BED95 ... BED750 are designed for both star and delta contactors with or without mechanical interlock unit.

Ordering details

For contactors	Interlock unit between star and delta contactors	Type	Order code	Weight Pkg (1 pce) kg	
Line and delta	Star				
A63	A40	-	BED50-1	1SBN083503R1001	0.180
		VE5-2	BED50	1SBN083503R1000	0.280
A75	A50	-	BED75-1	1SBN084103R1001	0.180
		VE5-2	BED75	1SBN084103R1000	0.250
A95	A75	VE5-2	BED95	1SFN084303R1000	0.400
A110	A95	VE5-2	BED110	1SFN084503R1000	0.500
A145	A110	VM300H	BED145A	1SFN084703R1000	1.300
A185	A145	VM300H	BED185	1SFN084903R1000	1.100
A210	A185	VM300H	BED210	1SFN085103R1000	1.500
A260	A210	VM300H	BED300	1SFN085303R1000	2.100
A300	A260				
AF400	A260	VM300/460H	BED400	1SFN085503R1000	3.500
AF460	A300				
AF460	AF400	VM750H	BED460	1SFN085703R1000	4.700
AF580	AF400	VM750H	BED580	1SFN085903R1000	6.300
AF580	AF460				
AF750	AF580	VM750H	BED750	1SFN086103R1000	7.700

Note: The connections provided for A... contactors can be used for the AL, AE, TAL and TAE types.

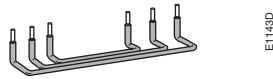

BED 75-1

E1143D

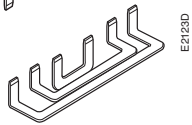
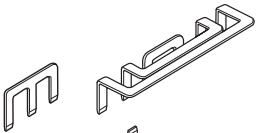

BED 110

E2123D

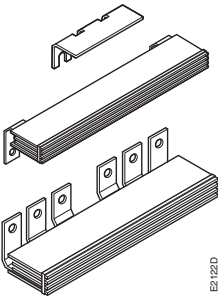

BED 185

E2121D

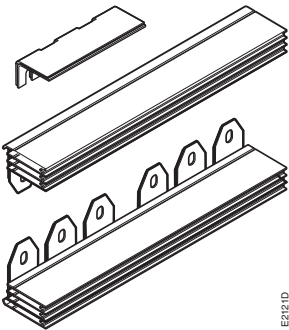

BED 400

E2121D

Mounting plates for A95 ... AF750 contactors

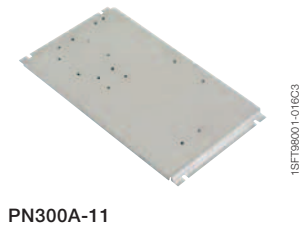

PN300A-11

1SFT98001-016C3

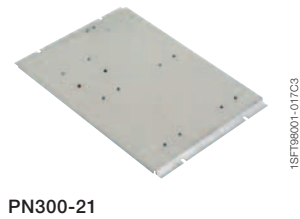

PN300-21

1SFT98001-017C3

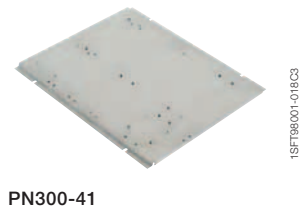

PN300-41

1SFT98001-018C3

Description

Mounting plates with fixing holes for the specified contactors and overload relays.

Ordering details

For contactors	For overload relays	Type	Order code	Pkg qty	Weight (1 pce)
					kg

Mounting plates for Direct on line starters

A145, A185	TA200DU, E200DU	PN185-11	1SFN094705R1000	1	1.100
A210 ... A300	TA450DU, E320DU	PN300A-11	1SFN095105R1000	1	1.650
AF400, AF460	E500DU	PN460-11	1SFN095705R1000	1	2.120
AF580, AF750	E800DU	PN750-11	1SFN096105R1000	1	2.500

For two contactors side by side with space for mechanical interlock	For one or two overload relays	Type	Order code	Pkg qty	Weight (1 pce)
					kg

Mounting plates for mechanical interlocked contactors, reversing starters and two speed starters for double windings

A95, A110	TA80DU, TA110DU	PN110-21	1SFN094301R1000	1	0.600
A145, A185	TA200DU, E200DU	PN185-21	1SFN094701R1000	1	1.800
A210 ... A300	TA450DU, E320DU	PN300-21	1SFN095101R1000	1	2.530
AF400, AF460	E500DU	PN460-21	1SFN095701R1000	1	3.490
AF580, AF750	E800DU	PN750-21	1SFN096101R1000	1	4.230

For main and delta contactors	For star contactor (1)	For overload relays	Type	Order code	Pkg qty	Weight (1 pce)
						kg

Mounting plates for star-delta starters and two speed starters for single windings

A95, A110	A75, A95	TA80DU or TA110DU	PN110-41	1SFN094303R1000	1	0.950
A145, A185	A110, A145	E200DU or TA200DU	PN185-41	1SFN094903R1000	1	2.440
A210 ... A300	A185 ... A300	E320DU or TA450DU	PN300-41	1SFN095503R1000	1	3.440
AF400, AF460	A300, AF400	E500DU	PN460-41	1SFN095703R1000	1	5.310
AF580, AF750	AF400 ... AF580	E800DU	PN750-41	1SFN096103R1000	1	6.320

(1) Space for mechanical interlock included

Note: The mounting plates provided for A... contactors can be used for the AF... contactors.

Adapter plates for A95 ... AF750 contactors

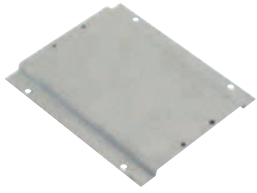

1SF198001-015C3

PR300-1



1SF198001-014C3

PR400-2

Description

Adapter plates with fixing holes for specified old contactors to new contactors.

Ordering details

From old contactors	To new contactor	Type	Order code	Pkg qty	Weight (1 pce)
					kg
EH65, EH75, EH80, EH90, EG80	A95, A110	PR110-1	1SFN094500R1000	1	0.270
EH100, EH145	A110, A145	PR145-1	1SFN094700R1000	1	0.360
EH150, EH160, EH175, EH210, EG160	A185, A210	PR210-1	1SFN094900R1000	1	0.440
EH250, EH260, EH300	A210 ... A300	PR300-1	1SFN095300R1000	1	0.560
EH370, EH550, EG315	AF400 ... AF580	PR460-1	1SFN095700R1000	1	0.900
EH700, EH800	AF750	PR750-1	1SFN096100R1000	1	0.500
OKYM150, OKYM175	A185	PR185-2	1SFN095100R1001	1	0.500
OKYM200, OKYM250	A210 ... A300	PR300-2	1SFN095300R1001	1	0.500
OKYM315	AF400, AF460	PR400-2	1SFN095700R1002	1	0.820
OKYM400	AF400, AF460	PR460-2	1SFN095700R1001	1	0.800
OKYM500	AF580	PR580-2	1SFN096100R1002	1	0.700
EH550, EG630, OKYM630	AF580, AF750	PR750-2	1SFN096100R1001	1	1.100

Note: The adapter plates provided for the A... contactors can also be used for the AF... contactors.

Dimensions (mm)

Type of the plate	Dimensions			Fixing holes mm
	L	l	h	
PR110-1	151	106	11.2	2 x ø 7
PR145-1	180	122	11.5	4 x ø 7
PR210-1	200	132	11.5	4 x ø 7
PR300-1	200	172	11.5	4 x ø 7
PR460-1	278	198	11.5	4 x ø 7
PR750-1	283	244	11.5	4 x ø 7
PR185-2	202	152	11.2	4 x ø 11
PR300-2	202	152	11.2	4 x ø 11
PR400-2	278	151	11.5	4 x ø 11
PR460-2	278	176	11.5	4 x ø 11
PR580-2	283	176	11.5	4 x ø 11
PR750-2	283	255	11.5	4 x ø 14

Note: The adapter plates provided for the A... contactors can also be used for the AF... contactors.
Fixing holes according to the plate types

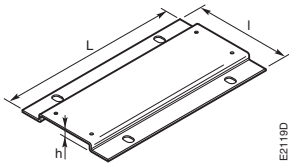

E2119D

Main contact sets Arc chutes for 3-pole contactors

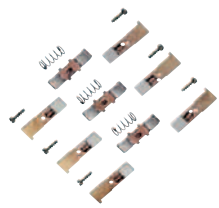

ZL50

1SBN656439F0001



ZL185

1SFT98099-007C3

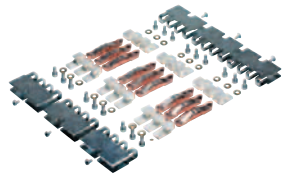

ZL1650

1SFT101008F0201

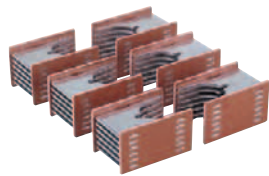

ZW...

1SFT98099-018

ZL..., ZLU... Main contact sets

Description

The contact sets for 3-pole contactors consists of six fixed contacts, three moving contacts, springs and the required screws.

Ordering details

For contactors	Type	Order code	Pkg qty	Weight (1 pce) kg
A/AF/AE/TAE50-30	ZL50	1SBN163503R1000	1	0.115
A/AF/AE/TAE63-30	ZL63	1SBN163703R1000	1	0.130
A/AF/AE/TAE75-30	ZL75	1SBN164103R1000	1	0.145
A/AF95-30	ZL95	1SFN164303R1000	1	0.190
A/AF110-30	ZL110	1SFN164503R1000	1	0.190
A/AF145	ZL145	1SFN164703R1000	1	0.380
A/AF185	ZL185	1SFN164903R1000	1	0.380
A/AF210	ZL210	1SFN165103R1000	1	0.670
A/AF260	ZL260	1SFN165303R1000	1	0.670
A/AF300	ZL300	1SFN165503R1000	1	0.670
AF400	ZL400	1SFN165703R1000	1	1.320
AF460	ZL460	1SFN165903R1000	1	1.320
AF580	ZL580	1SFN166103R1000	1	1.840
AF750	ZL750	1SFN166303R1000	1	1.840
AF1250	ZL1250	1SFN166403R1000	1	1.840
AF1350	ZL1350	1SFN166503R1000	1	2.500
AF1650	ZL1650	1SFN166703R1000	1	3.500
AF2050	ZL2050	1SFN167003R1000	1	3.500
UA50	ZLU50	1SBN163502R1000	1	0.115
UA63	ZLU63	1SBN163702R1000	1	0.145
UA75	ZLU75	1SBN164102R1000	1	0.145
UA95	ZLU95	1SFN164302R1000	1	0.190
UA110	ZLU110	1SFN164502R1000	1	0.190

ZW... Arc chutes for 3-pole contactors

Ordering details

For contactors	Type	Order code	Pkg qty	Weight (1 pce) kg
A145 ... A185 and AF145 ... AF185	ZW185	1SFN164710R1000	1	0.360
A210 ... A300 and AF210 ... AF300	ZW300	1SFN165110R1000	1	0.410
AF400, AF460	ZW460	1SFN165710R1000	1	1.380
AF580, AF750, AF1250	ZW750	1SFN166110R1000	1	1.500
AF1350, AF1650, AF2050	ZW1650	1SFN166510R1000	1	4.000

Contactors coils



ZA16

1SBC573802FC002



ZA185

1SFT98099-010C3

Description

Coils for A40 ... A300, UA16 ... UA110 and UA16..RA ... UA110..RA AC operated contactors.

Ordering details

For contactors	Rated control circuit voltage Uc		Type	Order code	Pkg qty	Weight (1 pce) kg
	V 50 Hz	V 60 Hz				
UA16, UA16..RA	24	24	ZA16	1SBN151410R8106	1	0.093
	48	48	ZA16	1SBN151410R8306	1	0.093
	110	110...120	ZA16	1SBN151410R8406	1	0.093
	220...230	230...240	ZA16	1SBN151410R8006	1	0.093
	230...240	240...260	ZA16	1SBN151410R8806	1	0.093
	380...400	400...415	ZA16	1SBN151410R8506	1	0.093
A40 UA26, UA30, UA26..RA, UA30..RA	400...415	415...440	ZA16	1SBN151410R8606	1	0.093
	24	24	ZA40	1SBN152410R8106	1	0.148
	48	48	ZA40	1SBN152410R8306	1	0.148
	110	110...120	ZA40	1SBN152410R8406	1	0.148
	220...230	230...240	ZA40	1SBN152410R8006	1	0.148
	230...240	240...260	ZA40	1SBN152410R8806	1	0.148
A45 ... A75 UA50 ... UA75 UA50..RA ... UA75..RA GA75	380...400	400...415	ZA40	1SBN152410R8506	1	0.148
	400...415	415...440	ZA40	1SBN152410R8606	1	0.148
	24	24	ZA75	1SBN153510R8106	1	0.166
	48	48	ZA75	1SBN153510R8306	1	0.166
	110	110...120	ZA75	1SBN153510R8406	1	0.166
	220...230	230...240	ZA75	1SBN153510R8006	1	0.166
A95, A110 UA95, UA110 UA95..RA, UA110..RA	230...240	240...260	ZA75	1SBN153510R8806	1	0.166
	380...400	400...415	ZA75	1SBN153510R8506	1	0.166
	400...415	415...440	ZA75	1SBN153510R8606	1	0.166
	24	24	ZA110	1SFN154310R8106	1	0.170
	48	48	ZA110	1SFN154310R8306	1	0.170
	110	110...120	ZA110	1SFN154310R8406	1	0.170
A145 ... A185	220...230	230...240	ZA110	1SFN154310R8006	1	0.170
	230...240	240...260	ZA110	1SFN154310R8806	1	0.170
	380...400	400...415	ZA110	1SFN154310R8506	1	0.170
	400...415	415...440	ZA110	1SFN154310R8606	1	0.170
	24	24	ZA185	1SFN154710R8106	1	0.180
	48	48	ZA185	1SFN154710R8306	1	0.180
A210 ... A300	110	110...120	ZA185	1SFN154710R8406	1	0.180
	220...230	230...240	ZA185	1SFN154710R8006	1	0.180
	230...240	240...260	ZA185	1SFN154710R8806	1	0.180
	380...400	400...415	ZA185	1SFN154710R8506	1	0.180
	400...415	415...440	ZA185	1SFN154710R8606	1	0.180
	24	24	ZA300	1SFN155110R8106	1	0.400
A210 ... A300	48	48	ZA300	1SFN155110R8306	1	0.400
	110	110...120	ZA300	1SFN155110R8406	1	0.400
	220...230	230...240	ZA300	1SFN155110R8006	1	0.400
	230...240	240...260	ZA300	1SFN155110R8806	1	0.400
	380...400	400...415	ZA300	1SFN155110R8506	1	0.400
	400...415	415...440	ZA300	1SFN155110R8606	1	0.400

Contactor coils



1SBC578683F0302

ZAF110



1SFT18601-13

ZAF300



1SFC101007R0201

ZAF1650

Description

Coils for AF45 ... AF2050 AC / DC operated contactors.

Ordering details

For contactors	Rated control circuit voltage		Type	Order code	Pkg qty	Weight (1 pce)
	Uc min. ... Uc max.					
	V 50/60 Hz	V DC				kg
AF45 ... AF75	-	20...60	ZAF75	1SBN153570R7206	1	0.170
	48...130	48...130	ZAF75	1SBN153570R6906	1	0.170
	100...250	100...250	ZAF75	1SBN153570R7006	1	0.170
AF95, AF110	-	20...60	ZAF110	1SFN154370R7206	1	0.200
	48...130	48...130	ZAF110	1SFN154370R6906	1	0.200
	100...250	100...250	ZAF110	1SFN154370R7006	1	0.200
AF145, AF185	-	20...60	ZAF185	1SFN154770R7206	1	0.225
	48...130	48...130	ZAF185	1SFN154770R6906	1	0.225
	100...250	100...250	ZAF185	1SFN154770R7006	1	0.225
AF210 ... AF300	-	20...60	ZAF300	1SFN155170R7206	1	0.450
	48...130	48...130	ZAF300	1SFN155170R6906	1	0.450
	100...250	100...250	ZAF300	1SFN155170R7006	1	0.450
AF400, AF460	-	24...60	ZAF460	1SFN155770R6806	1	0.525
	48...130	48...130	ZAF460	1SFN155770R6906	1	0.525
	100...250	100...250	ZAF460	1SFN155770R7006	1	0.525
	250...500	250...500	ZAF460	1SFN155770R7106	1	0.525
AF580 ... AF1250	-	24...60	ZAF750	1SFN156170R6806	1	1.335
	48...130	48...130	ZAF750	1SFN156170R6906	1	1.335
	100...250	100...250	ZAF750	1SFN156170R7006	1	1.335
	250...500	250...500	ZAF750	1SFN156170R7106	1	1.335
AF1350 ... AF2050	100...250	100...250	ZAF1650 (1)	1SFN156570R7026	1 set	0.900
			ZP1650 (2)	1SFN166521R1070	1	0.300

(1) One set of two coil.

(2) Printed circuit board.

Accessories for EK100 ... EK1000 contactors

Auxiliary contact blocks	5/148
Terminal shrouds	5/149
Surge suppressors for contactor coils	5/150
Mounting plates	5/151
Connection sets	5/152
Mechanical interlock units	5/153
Mechanical and electrical interlock units	5/153
Main contact sets - Arc chutes	5/154
Contactor coils	5/155

Auxiliary contact blocks

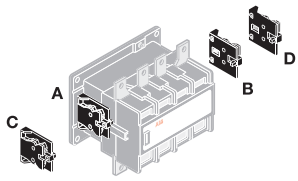

Mounting positions of the CAL16-11

E2074D

Description

The auxiliary contact blocks are used for the operation of auxiliary circuits and control circuits.

Types of auxiliary contact blocks for standard industrial environments:

- CAL instantaneous with N.O. + N.C. contacts
- CCL N.O. leading contact + N.C. lagging contact.

The auxiliary contact blocks are equipped with screw type connecting terminals delivered open, protected against accidental direct contact, and bear the corresponding function marking.

Mounting: Screwed onto the right and / or lefthand side of the EK110 ... EK1000 contactors.

Ordering details

For contactors	Number of blocks	Auxiliary contacts	Type	Order code	Pkg qty	Weight (1 pce)
						kg

2-pole auxiliary contacts N.O. + N.C.

EK	1	1 1 - -	CAL16-11A	SK829002-A	1	0.050
	1	1 1 - -	CAL16-11B	SK829002-B	1	0.050
	1	1 1 - -	CAL16-11C	SK829002-C	1	0.050
	1	1 1 - -	CAL16-11D	SK829002-D	1	0.050
	1	1 - - 1	CCL16-11E (1)	SK829002-E	1	0.050

(1) Mounting of CCL16-11E blocks does not allow an additional second block to be added on top of it.
All DC operated EK... contactors are equipped with one CCL16-11E on the right side.

Terminal shrouds



LT210-EK

1SFC01002F0201C03

Description

The use of terminal shrouds on the main terminals of EK... contactors is required in electrical panels or cubicles to be built in compliance with the rules for protection against direct contact with live parts in acc. with EN 50274.

On EK110 ... EK1000 contactors:

- The auxiliary contact blocks and coils are designed to provide an IP20 degree of protection
- The main terminals, equipped with lugs or connectors, can be protected against accidental direct contact after wiring (EN 50274) by the addition of terminal shrouds (see table below).

Each terminal shroud protects all the terminals on one side of the contactor. Two terminal shrouds should be provided for each separate contactor.

Ordering details

For contactors	Type	Order code	Pkg qty	Weight (1 pce) kg
EK110, EK150	LT150-EK	SK178001-HB	1	0.139
EK175, EK210	LT210-EK	SK178001-KB	1	0.152
EK370, EK550	LT550-EK	SK178001-LB	1	0.190
EK1000	LT1000-EK	SK178001-MB	1	0.200

Surge suppressors for contactor coils

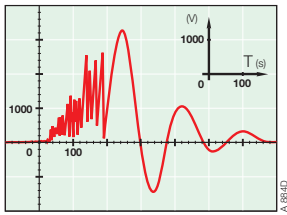

Description

The operation of inductive circuits causes overvoltages, in particular on opening of the contactor coil. The electromagnetic energy stored in the coil during contactor closing is restored on opening in the form of surges, the slope and amplitude of which may rise to several kilovolts. A number of drawbacks are observed ranging from interference on the electronic devices to breakdown of insulators and even destruction of certain sensitive components.

The graph opposite reproduces the oscillogram showing voltage discharges at the terminals of a 42 V / 50 Hz coil without peak clipping. The coil was switched by 8 series-connected poles of a contactor relay. Following a burst of discharges with a very steep slope a damped oscillation emerges with a peak value of 3500 V.

Overvoltage Factor

The overvoltage factor k is defined as the ratio of the maximum overvoltage peak value \hat{U}_s to the peak value \hat{U}_c of the coil rated control voltage U_c :

$$k = \frac{\hat{U}_s \text{ max.}}{\hat{U}_c} \quad \text{in DC: } k = \frac{\hat{U}_s \text{ max.}}{U_c} \quad \text{or in AC: } k = \frac{\hat{U}_s \text{ max.}}{U_c \sqrt{2}}$$

For example the following is obtained for the above graph: $k = \frac{3500}{42 \sqrt{2}} \approx 60$

To reduce the harmful effects of these overvoltages, ABB has developed a range of surge suppressors designed to reduce the k factor defined above and to limit or even completely eliminate the high pre-damping voltage frequencies.

Each case is different, but the technical data tolerances and the generous sizing of parts have enabled us to reduce the number of variants.

We have chosen the following solutions: transil diodes, varistors and RC blocks.

Note: A varistor is a resistor whose value decreases to a very large extent when a certain voltage is applied at its terminals.



RC-EH300/48

Ordering details

For contactors	Rated control circuit voltage U_c			Type	Order code	Pkg qty	Weight (1 pce) kg
	V	AC	DC				
EK110 ... EK210	24...48	●	-	RC-EH300/48	SK829007-A	1	0.015
	110...415	●	-	RC-EH300/415	SK829007-B	1	0.015
EK370 ... EK1000	48...110	●	-	RC-EH800/110	SK829007-C	1	0.015
EK110 ... EK1000	24...125	-	●	RC-EH800/110	SK829007-C	1	0.015
EK370 ... EK1000	220...600	●	-	RC-EH800/600	SK829007-D	1	0.015

Mounting plates

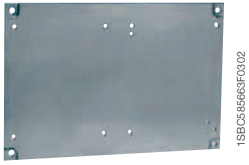

PN...

Description

Mounting plates for two horizontal mounted contactors with or without a mechanical interlock unit.

Ordering details

To use with:			Type	Order code	Pkg qty	Weight (1 pce) kg
Left hand contactor	Mechanical interlock	Right hand contactor				
EK110, EK150	VH145	EK110, EK150	PN210-22	SK829075-C	1	1.400
EK175, EK210	VH300	EK175, EK210	PN300-22	SK829075-E	1	2.070

(1) Space for mechanical interlock included.

Main dimensions mm

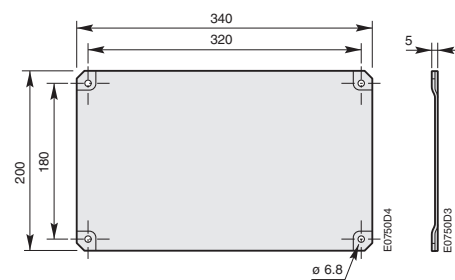

PN210-22

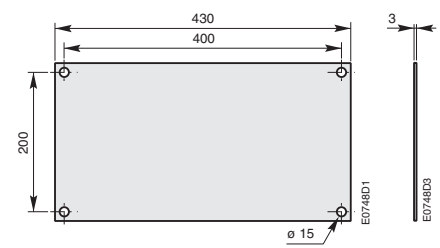

PN300-22

1SFC101069C0201

Connection sets

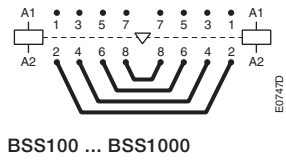

Description

Connection between the main poles of two 4-pole contactors mounted side by side so that they operate as source reversing contactors.

These sets are made up of four downstream connections.

BSS100 ... BSS210 – Insulated, flexible copper bars.

BSS550, BSS1000 – Bare, solid copper bars.

Ordering details

For contactors	Type	Order code	Pkg qty	Weight (1 pce) kg
Mechanical and electrical interlock units for two horizontal mounted contactors				
EK110	BSS100	SK829090-B	1	0.400
EK150	BSS145	SK829090-F	1	0.700
EK175, EK210	BSS210	SK829090-G	1	1.000
EK370, EK550	BSS550	SK829090-E	1	3.300
EK1000	BSS1000	SK829090-H	1	5.500

Mechanical interlock units

Mechanical and electrical interlock units



A093C4

Description

The mechanical interlock unit prevents one of the contactors from closing as long as the other contactor is closed.

- VH145, VH300 interlock units for mechanical and electrical interlocking of two horizontal mounted AC or DC operated EK110 ... EK1000 contactors.
- VH800 interlock unit for mechanical interlocking of two horizontal mounted AC or DC operated EK370 ... EK1000 contactors.

Ordering details

For contactors	Type	Order code	Pkg qty	Weight (1 pce) kg
----------------	------	------------	---------	-------------------

Mechanical and electrical interlock units for two horizontal mounted contactors

EK110, EK150	VH145	SK829071-A	1	0.130
EK175, EK210	VH300	SK829071-B	1	0.130

Mechanical interlock unit for two horizontal mounted contactors

EK370 ... EK1000	VH800	SK829070-F	1	6.000
------------------	-------	------------	---	-------



1SFC073492FC001

VH145

5

Selection table

For contactors				
Left	Right			
EK110, EK150	EK175, EK210	EK110, EK150	EK175, EK210	EK370 ... EK1000
EK110, EK150	-	VH145	-	-
EK175, EK210	-	-	VH300	-
EK370 ... EK1000	-	-	-	VH800
Fixing		PN210-22 mounting plate (to be supplied separately)	PN300-22 mounting plate (to be supplied separately)	Mounting plate included

KZK... Main contact sets

KWK... Arc chutes



1SFC10667 3P0304

KZK370

KZK main contact sets

Description

The contact sets for 4-pole contactors consist of eight fixed contacts, four moving contacts, springs and the necessary screws. In addition, the sets include four moving arcing contacts for EK370 ... EK1000 contactors.

Ordering details

For contactors	Type	Order code	Pkg qty	Weight (1 pce) kg
EK110	KZK110	SK824204-A	1	0.450
EK150	KZK150	SK824204-B	1	0.450
EK175	KZK175	SK825204-A	1	0.700
EK210	KZK210	SK825204-B	1	0.700
EK370	KZK370	SK827204-A	1	2.400
EK550	KZK550	SK827204-B	1	2.400
EK1000	KZK1000	SK827204-F	1	3.000

Arc chutes

Description

The arc chutes sets for EK 4-pole contactors contain 8 pieces.

Ordering details

For contactors	Type	Order code	Pkg qty	Weight (1 pce) kg
EK110	KWK110	5223351-AH	1	0.660
EK150	KWK150	5223351-AK	1	0.660
EK175	KWK175	5223351-AL	1	1.260
EK210	KWK210	5223351-AM	1	1.260
EK370	KWK370	5223351-Y	1	3.170
EK550	KWK550	5223351-Z	1	3.170
EK1000	KWK1000	5223351-AN	1	3.170

Contactors coils



KH300

1SFC273613FC02

Description

Coils for EK110 ... EK1000 - AC operated.

Ordering details

For contactors	Rated control circuit voltage U _c (1)		Type	Order code	Pkg qty	Weight (1 pce) kg
	V 50 Hz	V 60 Hz				
EK110 ... EK150	48	-	KH210	SK825400-AD	1	0.360
	-	110	KH210	SK825400-AE	1	0.360
	110	120	KH210	SK825400-AF	1	0.360
	220...230	-	KH210	SK825400-AL	1	0.360
	230...240	-	KH210	SK825400-AM	1	0.360
	-	380	KH210	SK825400-AN	1	0.360
	380...400	440	KH210	SK825400-AP	1	0.360
	400...415	-	KH210	SK825400-AR	1	0.360
EK175 ... EK210	48	-	KH300	SK826400-AD	1	0.440
	-	110	KH300	SK826400-AE	1	0.440
	110	120	KH300	SK826400-AF	1	0.440
	220...230	-	KH300	SK826400-AL	1	0.440
	230...240	-	KH300	SK826400-AM	1	0.440
	-	380	KH300	SK826400-AN	1	0.440
	380...400	440	KH300	SK826400-AP	1	0.440
	400...415	-	KH300	SK826400-AR	1	0.440
EK370 ... EK1000	48	-	KH800	SK828100-AD	1	0.950
	110	110...120	KH800	SK828100-EF	1	0.950
	110...115	115...127	KH800	SK828100-EG	1	0.950
	220	220...240	KH800	SK828100-EL	1	0.950
	220...230	230...255	KH800	SK828100-EM	1	0.950
	380	380...415	KH800	SK828100-EP	1	0.950
	380...400	400...440	KH800	SK828100-ER	1	0.950
	400...415	-	KH800	SK828100-AR	1	0.950

(1) Other control voltages, see voltage code table.

Contactors coils

Description

- Coils for EK110 ... EK1000 - DC operated with sets including a DC coil, an economy resistor and a insertion contact.
- Coils for EK110 ... EK210 - Multi-frequency coil and an insertion contact for contactor with built-in rectifier.

Ordering details

For contactors	Rated control circuit voltage Uc (1) V DC	Type	Order code	Pkg qty	Weight (1 pce) kg
EK110 ... EK150	12	KP210	SK825450-DA	1 set	0.450
	24	KP210	SK825450-DB	1 set	0.450
	36	KP210	SK825450-DC	1 set	0.450
	48	KP210	SK825450-DD	1 set	0.450
	60	KP210	SK825450-DT	1 set	0.450
	75	KP210	SK825450-DG	1 set	0.450
	110	KP210	SK825450-DE	1 set	0.450
	125	KP210	SK825450-DU	1 set	0.450
EK175 ... EK210	220	KP210	SK825450-DF	1 set	0.450
	12	KP300	SK826450-DA	1 set	0.550
	24	KP300	SK826450-DB	1 set	0.550
	36	KP300	SK826450-DC	1 set	0.550
	48	KP300	SK826450-DD	1 set	0.550
	60	KP300	SK826450-DT	1 set	0.550
	75	KP300	SK826450-DG	1 set	0.550
	110	KP300	SK826450-DE	1 set	0.550
EK3700 ... EK1000	125	KP300	SK826450-DU	1 set	0.550
	220	KP300	SK826450-DF	1 set	0.550
	24	KP800	SK828150-DB	1 set	1.060
	36	KP800	SK828150-DC	1 set	1.060
	48	KP800	SK828150-DD	1 set	1.060
	60	KP800	SK828150-DT	1 set	1.060
	75	KP800	SK828150-DG	1 set	1.060
	110	KP800	SK828150-DE	1 set	1.060
125	KP800	SK828150-DU	1 set	1.060	
220	KP800	SK828150-DF	1 set	1.060	

Ordering details

For contactors	Rated control circuit voltage Uc (1) V AC 40...400 Hz	Type	Order code	Pkg qty	Weight (1 pce) kg
EK110 ... EK150	110...120	KP210	SK825450-EF	1 set	0.450
	115...127	KP210	SK825450-EG	1 set	0.450
	220...230	KP210	SK825450-EL	1 set	0.450
	230...240	KP210	SK825450-EM	1 set	0.450
	380...400	KP210	SK825450-EP	1 set	0.450
	400...415	KP210	SK825450-ER	1 set	0.450
EK175 ... EK210	110...120	KP300	SK826450-EF	1 set	0.450
	115...127	KP300	SK826450-EG	1 set	0.450
	220...230	KP300	SK826450-EL	1 set	0.450
	230...240	KP300	SK826450-EM	1 set	0.450
	380...400	KP300	SK826450-EP	1 set	0.450
	400...415	KP300	SK826450-ER	1 set	0.450

(1) Other control voltages, see voltage code table.

Voltage code table

The below tables indicate the available coil voltages and corresponding digits for order codes. When placing an order, please give the order code. Select a standard contactor from ordering detail pages. Change the **coil voltage code** in the order code according to the table below. Example: for contactor A50-30-00 and coil 42 V 50/60 Hz, the order code is 1SBL351001R**8200**.

Contactors

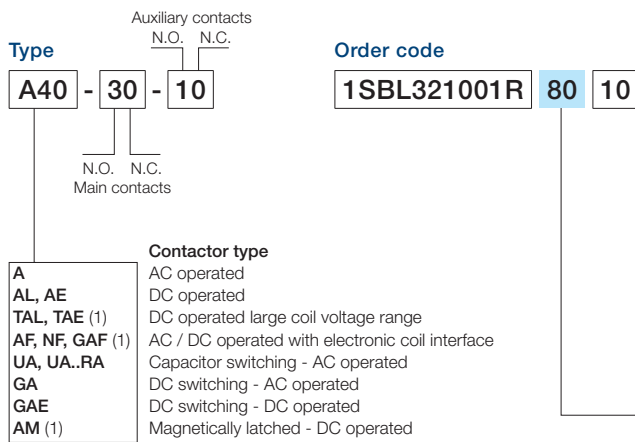

(1) TAL, TAE, AF, NF, GAF, AM all coil codes included in ordering detail pages.

AC coil code	
Contactors: A, UA, UA..RA, GA	
50 Hz	60 Hz
81	24 V
16	26 V
17	28 V
82	42 V
20	42 V
83	48 V
73	60 V
74	100 V (2)
26	105 V (2)
84	110 V
89	110...115 V
29	120 V
30	125...127 V
34	175 V
36	190 V
40	210 V
80	220...230 V
88	230...240 V
42	230...240 V
85	380...400 V
86	400...415 V
50	400 V
51	400...415 V
87	415...440 V
53	440 V
55	500 V
56	550 V
58	660...690 V
59	-

DC coil code	
Contactors: AL, AE, GAE	
80	12 V
81	24 V
82	42 V
83	48 V
21	50 V
84	60 V
85	75 V
86	110 V
87	125 V
88	220 V
89	240 V
38	250 V

Codes in bold for dual frequency coils.
 (2) Not for A145 ... A300 contactors.
 (3) A145 ... A300 contactors at 60 Hz 115 V only.

EK contactors

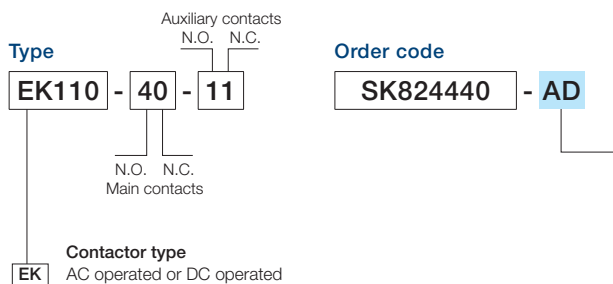

AC coil code	
Contactors: EK110 ... EK210	
50 Hz	60 Hz
AA	-
AB	24 V
AC	-
AD	48 V
AE	-
AF	110 V
AG	127 V
AZ	-
AH	190 V
AK	-
AL	220...230 V
AM	230...240 V
AN	-
AP	380...400 V
AR	400...415 V
AS	-
AT	440 V
AU	500 V
AV	-

AC coil code	
Contactors: EK370 ... EK1000	
50 Hz	60 Hz
AD	48 V
AE	-
AF	110 V
AG	127 V
AZ	-
AH	190 V
AK	-
AL	220...230 V
AM	230...240 V
AN	-
AP	380...400 V
AR	400...415 V
AS	-
AT	440 V
AU	500 V
AV	-

DC coil code	
Contactors: EK110 ... EK1000	
DA	12 V (4)
DB	24 V
DC	36 V
DD	48 V
DT	60 V
DG	75 V
DE	110 V
DU	125 V
DF	220 V

(4) Not for EK370 ... EK1000 contactors.

Multi-frequency coil code	
Contactors: EK110 ... EK210	
40...400 Hz	
EF	110...120 V
EG	115...127 V
EL	220...230 V
EM	230...240 V
EP	380...400 V
ER	400...415 V

Dual frequency coil code	
Contactors: EK370 ... EK1000	
50 Hz	60 Hz
EF	110 V
EG	110...115 V
EL	220 V
EM	220...230 V
EP	380 V
ER	380...400 V

2 auxiliary contact blocks maximum per contactor, ambient temperature ≤ 55 °C and mounting positions 2 and 6 excluded.



Overload relays

Thermal overload relays

T16 (0.10 ... 16.0 A)

Ordering details	6/2
Technical data	6/3

TF42 (0.10 ... 38.0 A)

Ordering details	6/6
Technical data	6/7

TA25DU (0.10 ... 32.0 A)

Ordering details	6/10
Technical data	6/11
Accessories	6/14

TA42DU (18.0 ... 42.0 A)

Ordering details	6/15
Technical data	6/16

TA75DU (18 ... 80 A)

Ordering details	6/19
Technical data	6/20

TA80DU (29 ... 80 A)

Ordering details	6/23
Technical data	6/24

TA110DU (66 ... 110 A)

Ordering details	6/27
Technical data	6/28

TA200DU (66 ... 200 A)

Ordering details	6/31
Technical data	6/32

TA450DU (130 ... 310 A)

Ordering details	6/35
Technical data	6/36

Electronic overload relays

E16DU, E45DU, E80DU, E140DU (0.10 to 140 A)

Ordering details	6/39
Technical data	6/40
Accessories	6/43

EF19, EF45 (0.10 to 45.0 A)

Ordering details	6/44
Technical data	6/45

E200DU, E320DU (60 to 320 A)

Ordering details	6/48
Technical data	6/49

E500DU, E800DU, E1250DU (150 to 1250 A)

Ordering details	6/51
Technical data	6/52

T16 thermal overload relays

0.10 ... 16.0 A



2CDC231012F0011

T16-16



2CDC239002F0011

T16 + DB16

6

Description

The T16 thermal overload relays are economic electromechanical protection devices for the main circuit. They offer reliable protection for motors in the event of overload or phase failure. The devices have trip class 10.

The thermal overload relays are three pole relays with bimetal tripping elements. The motor current flows through the bimetal tripping elements and heats them directly and indirectly. In case of an overload (over current), the bimetal elements bent as a result of the heating. This leads to a release of the relay and a change of the contacts switching position (95-96 / 97-98).

- Manual or automatic reset selectable
- Phase loss sensitive acc. to IEC/EN 60947-4-1
- Two electrically isolated auxiliary contacts - 1 N.O. + 1 N.C.
- TEST and STOP function - Trip indication on the front
- Temperature compensation
- Suitable for three- and single-phase applications

Ordering details

Setting range	Short-circuit protective device	Trip class	Type	Order code	Weight (1 pce) kg
A					
0.10 ... 0.13	0.5 A, Fuse type T	10	T16-0.13	1SAZ711201R1005	0.100
0.13 ... 0.17	1.0 A, Fuse type T	10	T16-0.17	1SAZ711201R1008	0.100
0.17 ... 0.23	1.0 A, Fuse type T	10	T16-0.23	1SAZ711201R1009	0.100
0.23 ... 0.31	1.0 A, Fuse type T	10	T16-0.31	1SAZ711201R1013	0.100
0.31 ... 0.41	2.0 A, Fuse type gG	10	T16-0.41	1SAZ711201R1014	0.100
0.41 ... 0.55	2.0 A, Fuse type gG	10	T16-0.55	1SAZ711201R1017	0.100
0.55 ... 0.74	4.0 A, Fuse type gG	10	T16-0.74	1SAZ711201R1021	0.100
0.74 ... 1.00	6.0 A, Fuse type gG	10	T16-1.0	1SAZ711201R1023	0.100
1.00 ... 1.30	6.0 A, Fuse type gG	10	T16-1.3	1SAZ711201R1025	0.100
1.30 ... 1.70	10.0 A, Fuse type gG	10	T16-1.7	1SAZ711201R1028	0.100
1.70 ... 2.30	10.0 A, Fuse type gG	10	T16-2.3	1SAZ711201R1031	0.100
2.30 ... 3.10	10.0 A, Fuse type gG	10	T16-3.1	1SAZ711201R1033	0.100
3.10 ... 4.20	20.0 A, Fuse type gG	10	T16-4.2	1SAZ711201R1035	0.100
4.20 ... 5.70	20.0 A, Fuse type gG	10	T16-5.7	1SAZ711201R1038	0.100
5.70 ... 7.60	35.0 A, Fuse type gG	10	T16-7.6	1SAZ711201R1040	0.100
7.60 ... 10.0	35.0 A, Fuse type gG	10	T16-10	1SAZ711201R1043	0.104
10.0 ... 13.0	40.0 A, Fuse type gG	10	T16-13	1SAZ711201R1045	0.104
13.0 ... 16.0	40.0 A, Fuse type gG	10	T16-16	1SAZ711201R1047	0.104

Ordering details accessories

For thermal overload relays	Description	Type	Order code	Weight (1 pce) kg
T16	Single mounting kit	DB16	1SAZ701901R0001	0.032



2CDC231002F0011

DB16

Main dimensions mm, inches

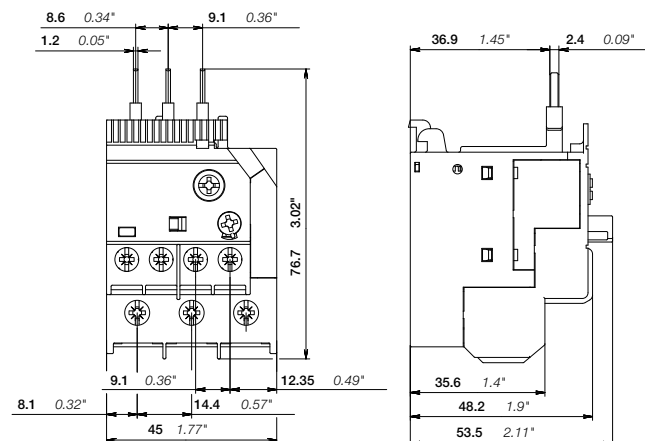

T16

2CDC23209F0008

2CDC106036C0201

T16 thermal overload relays

Technical data

Main circuit – Utilization characteristics according to IEC/EN

Type	T16
Standards	IEC/EN 60947-4-1, IEC/EN 60947-5-1, IEC/EN 60947-1
Rated operational voltage U_o	690 V AC - V DC
Rated frequency	50/60 Hz
Trip class	10
Number of poles	3
Duty time	100 %
Operating frequency without early tripping	Up to 15 operations/h, see "Technical diagram – Intermittent periodic duty"
Rated impulse withstand voltage U_{imp}	6 kV
Rated insulation voltage U_i	690 V AC

Auxiliary circuit according to IEC/EN

Type	T16
Rated operational voltage U_o	600 V
Conventional free air thermal current I_{th}	N.C., 95-96 6 A N.O., 97-98 4 A
Rated frequency	DC, 50/60 Hz
Number of poles	1 N.O. + 1 N.C.
I_o / Rated operational current AC-15 acc. to IEC/EN 60947-5-1 for utilization category	
110-120 V	N.C., 95-96 3.00 A N.O., 97-98 0.75 A
220-230-240 V	N.C., 95-96 3.00 A N.O., 97-98 0.75 A
440 V	N.C., 95-96 0.75 A N.O., 97-98 0.75 A
480-500 V	N.C., 95-96 0.75 A N.O., 97-98 0.75 A
I_o / Rated operational current DC-13 acc. to IEC/EN 60947-5-1 for utilization category	
24 V	N.C., 95-96 1.25 A N.O., 97-98 1.25 A
60 V	N.C., 95-96 0.55 A N.O., 97-98 0.55 A
110-120-125 V	N.C., 95-96 0.55 A N.O., 97-98 0.55 A
250 V	N.C., 95-96 0.27 A N.O., 97-98 0.27 A
Minimum switching capacity	17 V / 3 mA
Short-circuit protective device	N.C., 95-96 6 A, Fuse type gG N.O., 97-98 4 A, Fuse type gG
Rated impulse withstand voltage U_{imp}	6 kV
Rated insulation voltage U_i	690 V

Technical diagram – Intermittent periodic duty

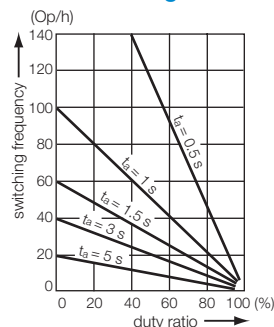

t_a : Motor starting time

2CDC23205F0211

T16 thermal overload relays

Technical data

Main circuit – Utilization characteristics according to UL/CSA

Type	T16
Standards	UL 508, CSA 22.2 No. 14
Maximum operational voltage	600 V AC
Trip rating	125 % of FLA
Full load amps (FLA)	See table "Full load amps and short-circuit protective device"
Short-circuit rating RMS symmetrical	See table "Full load amps and short-circuit protective device"
Short-circuit protective device	See table "Full load amps and short-circuit protective device"

Auxiliary circuit according to UL/CSA

Type	T16	
Contact rating	N.C., 95-96	B600, Q300
	N.O., 97-98	D300, Q300
Conventional thermal current	N.C., 95-96	5 A
	N.O., 97-98	2.5 A

6

Full load amps and short-circuit protective device

Type	Full load amps (FLA)	Short-circuit protective device			
		480 / 600 V AC		480 / 600 V AC	
		Short circuit rating RMS symmetrical	Fuse type	Short circuit rating RMS symmetrical	Fuse type
T16-0.13	0.13 A	18 kA	1 A, K5	100 kA	30 A, Class J
T16-0.17	0.17 A	18 kA	1 A, K5	100 kA	30 A, Class J
T16-0.23	0.23 A	18 kA	1 A, K5	100 kA	30 A, Class J
T16-0.31	0.31 A	18 kA	3 A, K5	100 kA	30 A, Class J
T16-0.41	0.41 A	18 kA	3 A, K5	100 kA	30 A, Class J
T16-0.55	0.55 A	18 kA	3 A, K5	100 kA	30 A, Class J
T16-0.74	0.74 A	18 kA	3 A, K5	100 kA	30 A, Class J
T16-1.0	1.00 A	18 kA	6 A, K5	100 kA	30 A, Class J
T16-1.3	1.30 A	18 kA	6 A, K5	100 kA	30 A, Class J
T16-1.7	1.70 A	18 kA	6 A, K5	100 kA	30 A, Class J
T16-2.3	2.30 A	18 kA	10 A, K5	100 kA	30 A, Class J
T16-3.1	3.10 A	18 kA	10 A, K5	100 kA	30 A, Class J
T16-4.2	4.20 A	18 kA	15 A, K5	100 kA	30 A, Class J
T16-5.7	5.70 A	18 kA	20 A, K5	100 kA	30 A, Class J
T16-7.6	7.60 A	18 kA	25 A, K5	100 kA	30 A, Class J
T16-10	10.0 A	18 kA	35 A, K5	100 kA	45 A, Class J
T16-13	13.0 A	18 kA	40 A, K5	100 kA	45 A, Class J
T16-16	16.0 A	18 kA	60 A, K5	100 kA	45 A, Class J

T16 thermal overload relays



Technical data

General technical data

Type	T16	
Pollution degree	3	
Phase loss sensitive	Yes	
Ambient air temperature		
Operation	Open - compensated without derating	-25 ... +60 °C
Storage	Open	-25 ... +60 °C
Storage		-50 ... +80 °C
Ambient air temperature compensation	Continuous	
Maximum operating altitude permissible	2000 m	
Resistance to shock acc. to IEC 60068-2-27	25 g / 11 ms	
Resistance to vibrations acc. to IEC 60068-2-6	3 g / 3 ... 150 Hz	
Mounting position	Position 1-5	
Mounting	Mount on the contactor and tighten the screws of the main circuit terminals or with single mounting kit on DIN rail (35 mm)	
Degree of protection	IP20	





Electrical connection

Main circuit

Type	T16	
Connecting capacity		
 Rigid	1 x	0.75 ... 4 mm ²
	2 x	0.75 ... 1.5 mm ² or 1.5 ... 4 mm ² ¹⁾
 Flexible	1 x or 2 x	0.75 ... 4 mm ²
Stranded acc. to UL/CSA	1 x or 2 x	AWG 18-10
Flexible acc. to UL/CSA	1 x or 2 x	AWG 18-10
Stripping length	12 mm	
Tightening torques	1.1 ... 1.5 Nm / 9 ... 13 lb.in	
Connection screw	M4 (Pozidriv 2)	

¹⁾ Combination of different wires not possible

Auxiliary circuit

Type	T16	
Connecting capacity		
 Rigid	1 x or 2 x	0.75 ... 4 mm ²
 Flexible with ferrule	1 x or 2 x	0.75 ... 2.5 mm ²
 Flexible with insulated ferrule	1 x	0.75 ... 2.5 mm ²
	2 x	0.75 ... 1.5 mm ²
 Flexible	1 x or 2 x	0.75 ... 1 mm ² or 1 ... 2.5 mm ²
Stranded acc. to UL/CSA	1 x or 2 x	AWG 18-12
Flexible acc. to UL/CSA	1 x or 2 x	AWG 18-12
Stripping length	9 mm	
Tightening torques	1.1 ... 1.5 Nm / 9 ... 13 lb.in	
Connection screw	M3 (Pozidriv 2)	

TF42 thermal overload relays

0.10 ... 38.0 A



1SBC101328P0010

TF42-38



2CDC231001F0011

DB42

Description

The TF42 thermal overload relays are economic electromechanical protection devices for the main circuit. They offer reliable protection for motors in the event of overload or phase failure. The devices have trip class 10.

The thermal overload relays are three pole relays with bimetal tripping elements. The motor current flows through the bimetal tripping elements and heats them directly and indirectly. In case of an overload (over current), the bimetal elements bent as a result of the heating. This leads to a release of the relay and a change of the contacts switching position (95-96 / 97-98).

- Phase loss sensitive acc. to IEC/EN 60947-4-1
- TEST and STOP function - Trip indication on the front
- Suitable for three- and single-phase applications
- Sealable cover

Ordering details

Setting range	Short-circuit protective device	Trip class	Type	Order code	Weight (1 pce) kg
0.10 ... 0.13	0.5 A, Fuse type T	10	TF42-0.13	1SAZ721201R1005	0.130
0.13 ... 0.17	1.0 A, Fuse type T	10	TF42-0.17	1SAZ721201R1008	0.130
0.17 ... 0.23	1.0 A, Fuse type T	10	TF42-0.23	1SAZ721201R1009	0.130
0.23 ... 0.31	1.0 A, Fuse type T	10	TF42-0.31	1SAZ721201R1013	0.130
0.31 ... 0.41	2.0 A, Fuse type gG	10	TF42-0.41	1SAZ721201R1014	0.130
0.41 ... 0.55	2.0 A, Fuse type gG	10	TF42-0.55	1SAZ721201R1017	0.130
0.55 ... 0.74	4.0 A, Fuse type gG	10	TF42-0.74	1SAZ721201R1021	0.130
0.74 ... 1.00	6.0 A, Fuse type gG	10	TF42-1.0	1SAZ721201R1023	0.130
1.00 ... 1.30	6.0 A, Fuse type gG	10	TF42-1.3	1SAZ721201R1025	0.130
1.30 ... 1.70	10.0 A, Fuse type gG	10	TF42-1.7	1SAZ721201R1028	0.130
1.70 ... 2.30	10.0 A, Fuse type gG	10	TF42-2.3	1SAZ721201R1031	0.130
2.30 ... 3.10	10.0 A, Fuse type gG	10	TF42-3.1	1SAZ721201R1033	0.130
3.10 ... 4.20	20.0 A, Fuse type gG	10	TF42-4.2	1SAZ721201R1035	0.130
4.20 ... 5.70	20.0 A, Fuse type gG	10	TF42-5.7	1SAZ721201R1038	0.130
5.70 ... 7.60	35.0 A, Fuse type gG	10	TF42-7.6	1SAZ721201R1040	0.130
7.60 ... 10.0	35.0 A, Fuse type gG	10	TF42-10	1SAZ721201R1043	0.130
10.0 ... 13.0	40.0 A, Fuse type gG	10	TF42-13	1SAZ721201R1045	0.130
13.0 ... 16.0	40.0 A, Fuse type gG	10	TF42-16	1SAZ721201R1047	0.130
16.0 ... 20.0	63.0 A, Fuse type gG	10	TF42-20	1SAZ721201R1049	0.145
20.0 ... 24.0	63.0 A, Fuse type gG	10	TF42-24	1SAZ721201R1051	0.145
24.0 ... 29.0	63.0 A, Fuse type gG	10	TF42-29	1SAZ721201R1052	0.145
29.0 ... 35.0	80.0 A, Fuse type gG	10	TF42-35	1SAZ721201R1053	0.145
35.0 ... 38.0/40.0	80.0 A, Fuse type gG	10	TF42-38	1SAZ721201R1055	0.145

Ordering details accessories

For thermal overload relays	Description	Type	Order code	Weight (1 pce) kg
TF42	Single mounting kit	DB42	1SAZ701902R0001	0.087

Main dimensions mm, inches

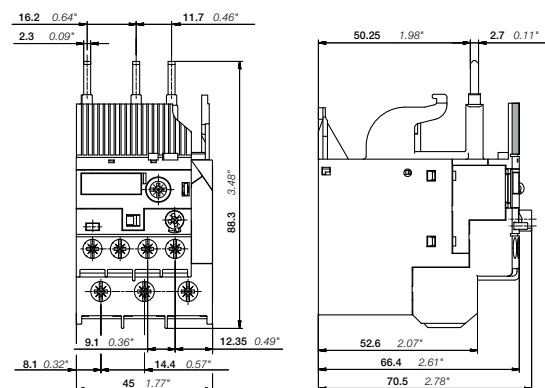

TF42

2CDC23005F0009

2CDC106046C0201

TF42 thermal overload relays

Technical data

Main circuit – Utilization characteristics according to IEC/EN

Type	TF42
Standards	IEC/EN 60947-4-1, IEC/EN 60947-5-1, IEC/EN 60947-1
Rated operational voltage U_e	690 V AC
Rated frequency	50/60 Hz
Trip class	10
Number of poles	3
Duty time	100 %
Operating frequency without early tripping	Up to 15 operations/h, see "Technical diagram – Intermittent periodic duty"
Rated impulse withstand voltage U_{imp}	6 kV
Rated insulation voltage U_i	690 V AC

Auxiliary circuit according to IEC/EN

Type	TF42
Rated operational voltage U_e	600 V
Conventional free air thermal current I_{th}	N.C., 95-96 6 A N.O., 97-98 4 A
Rated frequency	DC, 50/60 Hz
Number of poles	1 N.O. + 1 N.C.
I_e / Rated operational current AC-15 acc. to IEC/EN 60947-5-1 for utilization category	
110-120 V	N.C., 95-96 3.00 A N.O., 97-98 0.75 A
220-230-240 V	N.C., 95-96 3.00 A N.O., 97-98 0.75 A
440 V	N.C., 95-96 0.75 A N.O., 97-98 0.75 A
480-500 V	N.C., 95-96 0.75 A N.O., 97-98 0.75 A
I_e / Rated operational current DC-13 acc. to IEC/EN 60947-5-1 for utilization category	
24 V	N.C., 95-96 1.25 A N.O., 97-98 1.25 A
110-120-125 V	N.C., 95-96 0.55 A N.O., 97-98 0.55 A
250 V	N.C., 95-96 0.27 A N.O., 97-98 0.27 A
Minimum switching capacity	17 V / 3 mA
Short-circuit protective device	N.C., 95-96 6 A, Fuse type gG N.O., 97-98 4 A, Fuse type gG
Rated impulse withstand voltage U_{imp}	6 kV
Rated insulation voltage U_i	690 V

Technical diagram – Intermittent periodic duty

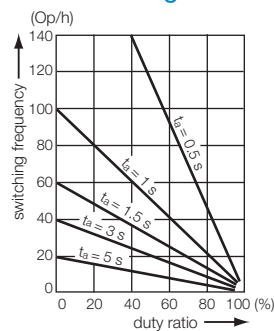

t_s : Motor starting time

2CDC32000F0211

TF42 thermal overload relays

Technical data

Main circuit – Utilization characteristics according to UL/CSA

Type	TF42
Standards	UL 508, CSA 22.2 No. 14
Maximum operational voltage	600 V AC
Trip rating	125 % of FLA
Full load amps (FLA)	See table "Full load amps and short-circuit protective device"
Short-circuit rating RMS symmetrical	See table "Full load amps and short-circuit protective device"
Short-circuit protective device	See table "Full load amps and short-circuit protective device"

Auxiliary circuit according to UL/CSA

Type	TF42	
Contact rating	N.C., 95-96	B600, Q300
	N.O., 97-98	D300, Q300
Conventional thermal current	N.C., 95-96	5 A
	N.O., 97-98	2.5 A

6

Full load amps and short-circuit protective device

Type	Full load amps (FLA)	Short-circuit protective device			
		480 / 600 V AC		480 / 600 V AC	
		Short circuit rating RMS symmetrical	Fuse type	Short circuit rating RMS symmetrical	Fuse type
TF42-0.13	0.13 A	18 kA	1 A, K5	100 kA	30 A, Class J
TF42-0.17	0.17 A	18 kA	1 A, K5	100 kA	30 A, Class J
TF42-0.23	0.23 A	18 kA	1 A, K5	100 kA	30 A, Class J
TF42-0.31	0.31 A	18 kA	3 A, K5	100 kA	30 A, Class J
TF42-0.41	0.41 A	18 kA	3 A, K5	100 kA	30 A, Class J
TF42-0.55	0.55 A	18 kA	3 A, K5	100 kA	30 A, Class J
TF42-0.74	0.74 A	18 kA	3 A, K5	100 kA	30 A, Class J
TF42-1.0	1.00 A	18 kA	6 A, K5	100 kA	30 A, Class J
TF42-1.3	1.30 A	18 kA	6 A, K5	100 kA	30 A, Class J
TF42-1.7	1.70 A	18 kA	6 A, K5	100 kA	30 A, Class J
TF42-2.3	2.30 A	18 kA	10 A, K5	100 kA	30 A, Class J
TF42-3.1	3.10 A	18 kA	10 A, K5	100 kA	30 A, Class J
TF42-4.2	4.20 A	18 kA	15 A, K5	100 kA	30 A, Class J
TF42-5.7	5.70 A	18 kA	20 A, K5	100 kA	30 A, Class J
TF42-7.6	7.60 A	18 kA	25 A, K5	100 kA	30 A, Class J
TF42-10	10.0 A	18 kA	35 A, K5	100 kA	45 A, Class J
TF42-13	13.0 A	18 kA	40 A, K5	100 kA	45 A, Class J
TF42-16	16.0 A	18 kA	60 A, K5	100 kA	45 A, Class J
TF42-20	20.0 A	18 kA	80 A, K5	100 kA	60 A, Class J
TF42-24	24.0 A	18 kA	80 A, K5	100 kA	60 A, Class J
TF42-29	29.0 A	18 kA	100 A, K5	100 kA	100 A, Class J
TF42-35	35.0 A	18 kA	150 A, K5	100 kA	175 A, Class J
TF42-38	38.0 A	18 kA	150 A, K5	100 kA	175 A, Class J

TF42 thermal overload relays



Technical data

General technical data

Type	TF42	
Pollution degree	3	
Phase loss sensitive	Yes	
Ambient air temperature		
Operation	Open - compensated without derating	-25 ... +60 °C
Storage	Open	-25 ... +60 °C
Storage		-50 ... +80 °C
Ambient air temperature compensation	Continuous	
Maximum operating altitude permissible	2000 m	
Resistance to shock acc. to IEC 60068-2-27	25 g / 11 ms	
Resistance to vibrations acc. to IEC 60068-2-6	3 g / 3 ... 150 Hz	
Mounting position	Position 1-5	
Mounting	Mount on the contactor and tighten the screws of the main circuit terminals or with single mounting kit on DIN rail (35 mm)	
Degree of protection	IP20	





Electrical connection

Main circuit

Type	TF42 (TF42-0.13 ... TF42-16)	TF42 (TF42-20 ... TF42-38)
Connecting capacity		
 Rigid	1 x or 2 x	0.75 ... 4 mm ²
 Flexible with insulated ferrule	1 x or 2 x	0.75 ... 4 mm ²
Stranded acc. to UL/CSA	1 x or 2 x	AWG 18-10
Flexible acc. to UL/CSA	1 x or 2 x	AWG 18-10
Stripping length	12 mm	
Tightening torques	1.5 - 2.5 Nm / 13 ... 22 lb.in	2.5 - 2.7 Nm / 22 lb.in
Connection screw	M4 (Pozidriv 2)	

¹⁾ Combination of different wires not possible

Auxiliary circuit

Type	TF42	
Connecting capacity		
 Rigid	1 x or 2 x	0.75 ... 4 mm ²
 Flexible with ferrule	1 x or 2 x	0.75 ... 2.5 mm ²
 Flexible with insulated ferrule	1 x	0.75 ... 2.5 mm ²
Flexible	2 x	0.75 ... 1.5 mm ²
 Flexible	1 x or 2 x	0.75 ... 1 mm ² or 1 ... 2.5 mm ²
Stranded acc. to UL/CSA	1 x or 2 x	AWG 18-12
Flexible acc. to UL/CSA	1 x or 2 x	AWG 18-12
Stripping length	9 mm	
Tightening torques	1.1 ... 1.5 Nm / 9 ... 13 lb.in	
Connection screw	M3 (Pozidriv 2)	

TA25DU thermal overload relays

With screw terminals - 0.10 ... 32.0 A



TA25DU-0.19

2CDC231 002F0009

Description

The TA25DU thermal overload relays are economic electromechanical protection devices for the main circuit. They offer reliable protection for motors in the event of overload or phase failure. The devices have trip class 10A.

The thermal overload relays are three pole relays with bimetal tripping elements. The motor current flows through the bimetal tripping elements and heats them directly and indirectly. In case of an overload (over current), the bimetal elements bent as a result of the heating. This leads to a release of the relay and a change of the contacts switching position (95-96 / 97-98).

- Manual or automatic reset selectable
- Phase loss sensitive acc. to IEC/EN 60947-4-1
- Two electrically isolated auxiliary contacts – 1 N.O. + 1 N.C.
- TEST and STOP function – Trip indication on the front
- Temperature compensation
- Suitable for three- and single-phase applications

Ordering details

Setting range	Short-circuit protective device	Trip class	Type	Order code	Weight (1 pce) kg
A					
0.10 ... 0.16	0.50 A, Fuse type F	10A	TA25DU-0.16	1SAZ211201R1005	0.150
0.16 ... 0.25	0.63 A, Fuse type F	10A	TA25DU-0.25	1SAZ211201R1009	0.150
0.25 ... 0.40	1.25 A, Fuse type F	10A	TA25DU-0.4	1SAZ211201R1013	0.150
0.40 ... 0.63	2 A, Fuse type gG / -	10A	TA25DU-0.63	1SAZ211201R1017	0.150
0.63 ... 1.00	4 A, Fuse type gG / 2 A aM	10A	TA25DU-1.0	1SAZ211201R1021	0.150
1.00 ... 1.40	6 A, Fuse type gG / 2 A aM	10A	TA25DU-1.4	1SAZ211201R1023	0.150
1.30 ... 1.80	6 A, Fuse type gG / 4 A aM	10A	TA25DU-1.8	1SAZ211201R1025	0.150
1.70 ... 2.40	6 A, Fuse type gG / 4 A aM	10A	TA25DU-2.4	1SAZ211201R1028	0.150
2.20 ... 3.10	10 A, Fuse type gG / 6 A aM	10A	TA25DU-3.1	1SAZ211201R1031	0.150
2.80 ... 4.00	10 A, Fuse type gG / 6 A aM	10A	TA25DU-4.0	1SAZ211201R1033	0.150
3.50 ... 5.00	16 A, Fuse type gG / 10 A aM	10A	TA25DU-5.0	1SAZ211201R1035	0.150
4.50 ... 6.50	20 A, Fuse type gG / 16 A aM	10A	TA25DU-6.5	1SAZ211201R1038	0.150
6.00 ... 8.50	20 A, Fuse type gG / 20 A aM	10A	TA25DU-8.5	1SAZ211201R1040	0.150
7.50 ... 11.00	35 A, Fuse type gG / 25 A aM	10A	TA25DU-11	1SAZ211201R1043	0.150
10.00 ... 14.00	35 A, Fuse type gG / 25 A aM	10A	TA25DU-14	1SAZ211201R1045	0.150
13.00 ... 19.00	50 A, Fuse type gG / 35 A aM	10A	TA25DU-19	1SAZ211201R1047	0.170
18.00 ... 25.00	63 A, Fuse type gG / 50 A aM	10A	TA25DU-25	1SAZ211201R1051	0.170
24.00 ... 32.00	80 A, Fuse type gG / 63 A aM	10A	TA25DU-32	1SAZ211201R1053	0.200

Main dimensions mm, inches

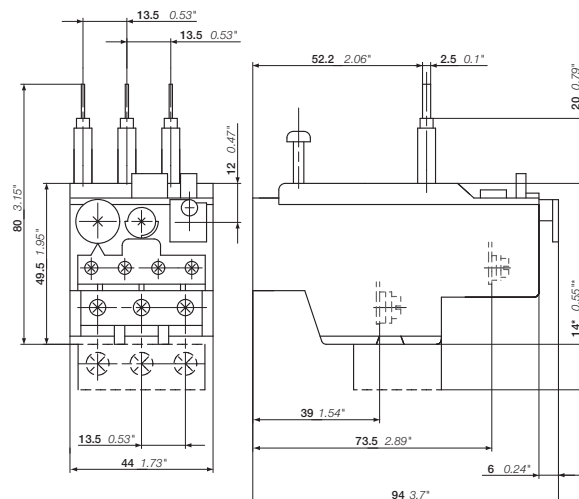

TA25DU + DX25

2CDC232023F0011

2CDC106039C0201

TA25DU thermal overload relays

Technical data

Main circuit – Utilization characteristics according to IEC/EN

Type	TA25DU
Standards	IEC/EN 60947-4-1, IEC/EN 60947-5-1, IEC/EN 60947-1
Rated operational voltage U_e	690 V AC
Rated frequency	DC, 50/60 Hz
Frequency range	0 ... 400 Hz
Trip class	10A
Number of poles	3
Duty time	100 %
Operating frequency without early tripping	Up to 15 operations/h, see "Technical diagram – Intermittent periodic duty"
Rated impulse withstand voltage U_{imp}	6 kV
Rated insulation voltage U_i	690 V AC

Auxiliary circuit according to IEC/EN

Type	TA25DU
Rated operational voltage U_e	500 V AC, 440 V DC
Conventional free air thermal current I_{th}	N.C., 95-96 10 A N.O., 97-98 6 A
Rated frequency	DC, 50/60 Hz
Number of poles	1 N.O. + 1 N.C.
I_e / Rated operational current AC-15 acc. to IEC/EN 60947-5-1 for utilization category	
110-120 V	N.C., 95-96 3.00 A N.O., 97-98 3.00 A
220-230-240 V	N.C., 95-96 3.00 A N.O., 97-98 3.00 A
440 V	N.C., 95-96 1.90 A N.O., 97-98 1.00 A
480-500 V	N.C., 95-96 1.00 A N.O., 97-98 1.00 A
I_e / Rated operational current DC-13 acc. to IEC/EN 60947-5-1 for utilization category	
24 V	N.C., 95-96 1.25 A N.O., 97-98 1.25 A
60 V	N.C., 95-96 0.25 A N.O., 97-98 0.25 A
110-120-125 V	N.C., 95-96 0.25 A N.O., 97-98 0.25 A
250 V	N.C., 95-96 0.12 A N.O., 97-98 0.04 A
Minimum switching capacity	17 V / 3 mA
Short-circuit protective device	N.C., 95-96 10 A, Fuse type gG N.O., 97-98 6 A, Fuse type gG
Rated impulse withstand voltage U_{imp}	6 kV
Rated insulation voltage U_i	690 V

Technical diagram – Intermittent periodic duty

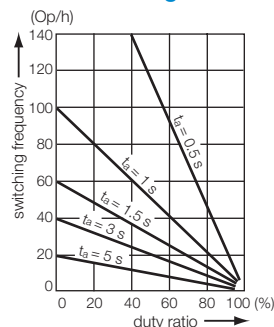

t_a : Motor starting time

2CDC232005F0211

TA25DU thermal overload relays

Technical data

Main circuit – Utilization characteristics according to UL/CSA

Type	TA25DU
Standards	UL 508, CSA 22.2 No. 14
Maximum operational voltage	600 V AC
Trip rating	125 % of FLA
Full load amps (FLA)	See table "Full load amps and short-circuit protective device"
Short-circuit rating RMS symmetrical	See table "Full load amps and short-circuit protective device"
Short-circuit protective device	See table "Full load amps and short-circuit protective device"

Auxiliary circuit according to UL/CSA

Type	TA25DU
Contact rating	N.C., 95-96 C600 N.O., 97-98 B600
Conventional thermal current	5 A

6

Full load amps and short-circuit protective device

Type	Full load amps (FLA)	Short-circuit protective device 480 / 600 V AC			480 / 600 V AC		480 / 600 V AC	
		Short circuit rating RMS symmetrical	Fuse type	Listed circuit breaker	Short circuit rating RMS symmetrical	Listed circuit breaker	Short circuit rating RMS symmetrical	Fuse type
TA25DU-0.16	0.16 A	5 kA	1.0 A, K5 / RK5	15 A	35 / 18 kA	15 A	50 kA	30 A, Class J
TA25DU-0.25	0.25 A	5 kA	1.0 A, K5 / RK5	15 A	35 / 18 kA	15 A	50 kA	30 A, Class J
TA25DU-0.4	0.40 A	5 kA	3.0 A, K5 / RK5	15 A	35 / 18 kA	15 A	50 kA	30 A, Class J
TA25DU-0.63	0.63 A	5 kA	3.0 A, K5 / RK5	15 A	35 / 18 kA	15 A	50 kA	30 A, Class J
TA25DU-1.0	1.0 A	5 kA	6.0 A, K5 / RK5	15 A	35 / 18 kA	15 A	50 kA	30 A, Class J
TA25DU-1.4	1.4 A	5 kA	6.0 A, K5 / RK5	15 A	35 / 18 kA	15 A	50 kA	30 A, Class J
TA25DU-1.8	1.8 A	5 kA	6.0 A, K5 / RK5	15 A	35 / 18 kA	15 A	50 kA	30 A, Class J
TA25DU-2.4	2.4 A	5 kA	10 A, K5 / RK5	15 A	35 / 18 kA	15 A	50 kA	30 A, Class J
TA25DU-3.1	3.1 A	5 kA	10 A, K5 / RK5	15 A	35 / 18 kA	15 A	50 kA	30 A, Class J
TA25DU-4.0	4.0 A	5 kA	15 A, K5 / RK5	15 A	35 / 18 kA	15 A	50 kA	30 A, Class J
TA25DU-5.0	5.0 A	5 kA	20 A, K5 / RK5	20 A	35 / 18 kA	20 A	50 kA	30 A, Class J
TA25DU-6.5	6.5 A	5 kA	25 A, K5 / RK5	20 A	35 / 18 kA	20 A	50 kA	30 A, Class J
TA25DU-8.5	8.5 A	5 kA	35 A, K5 / RK5	20 A	35 / 18 kA	20 A	50 kA	30 A, Class J
TA25DU-11	11 A	5 kA	45 A, K5 / RK5	50 A	35 / 18 kA	50 A	50 kA	35 A, Class J
TA25DU-14	14 A	5 kA	60 A, K5 / RK5	50 A	35 / 18 kA	50 A	50 kA	60 A, Class J
TA25DU-19	19 A	5 kA	60 A, K5 / RK5	50 A	35 / 18 kA	50 A	50 kA	60 A, Class J
TA25DU-25	25 A	5 kA	70 A, K5 / RK5	70 A	35 / 18 kA	70 A	50 kA	100 A, Class J
TA25DU-32	32 A	5 kA	100 A, K5 / RK5	100 A	35 / 18 kA	100 A	50 kA	100 A, Class J

TA25DU thermal overload relays



Technical data

General technical data

Type	TA25DU		
Pollution degree	3		
Phase loss sensitive	Yes		
Ambient air temperature			
Operation	Open - compensated without derating	-25 ... +55 °C	
Storage	Open	-25 ... +55 °C	
Storage		-40 ... +70 °C	
Ambient air temperature compensation	Continuous		
Maximum operating altitude permissible	2000 m		
Resistance to shock acc. to IEC 60068-2-27	12 g / 15 ms		
Mounting position	Position 1-6		
Mounting	Mount on the contactor and tighten the screws of the main circuit terminals or with single mounting kit on DIN rail (35 mm)		
Degree of protection	IP20		



Electrical connection

Main circuit

Type	TA25DU (0.16-11 A)	TA25DU (14-25 A)	TA25DU (32 A)
Connecting capacity			
 Rigid	1 x 0.75 ... 4 mm ² 2 x 0.75 ... 4 mm ²	1.5 ... 6 mm ² 1.5 ... 6 mm ²	1.5 ... 10 mm ² -
 Flexible with insulated ferrule	1 x or 2 x ¹⁾ 0.75 ... 4 mm ²	1.5 ... 4 mm ²	1.5 ... 6 mm ²
Stranded acc. to UL/CSA	1 x AWG 16-8 2 x AWG 16-8	AWG 16-8 AWG 16-8	AWG 10-8 -
Flexible acc. to UL/CSA	1 x AWG 16-8 2 x AWG 16-8	AWG 16-8 AWG 16-8	AWG 10-8 -
Stripping length	12 mm	12 mm	15 mm
Tightening torques	1.4 - 2.0 Nm / 12 lb.in	1.4 - 2.0 Nm / 12 lb.in	2.5 - 3.2 Nm / 20 lb.in
Connection screw	M4 (Pozidriv 2)	M4 (Pozidriv 2)	M5 (Pozidriv 2)

¹⁾ Combination of different wires not possible

Auxiliary circuit

Type	TA25DU
Connecting capacity	
 Rigid	1 x or 2 x 0.75 ... 4 mm ²
 Flexible	1 x or 2 x 0.75 ... 2.5 mm ²
Stranded acc. to UL/CSA	1 x or 2 x AWG 18-14
Flexible acc. to UL/CSA	1 x or 2 x AWG 18-14
Stripping length	9 mm
Tightening torques	0.8 ... 1.3 Nm / 12 lb.in
Connection screw	M3.5 (Pozidriv 2)

TA25DU thermal overload relays

Accessories



DX25



DB25/25A



DS25-A-220/380

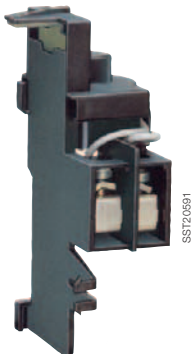

DR25-A-220/380

Description

The single mounting kits offer the possibility to mount the overload relays separately from the contactor. The DS25-A allows electrically remote tripping of TA25DU. DR25-A coil for remote reset of TA25DU.

Ordering details

For thermal overload relays	Description	Type	Order code	Weight (1 pce) kg
Terminal block and mounting kits				
TA25DU-0.16 ... 25 / DB25/25 A	Terminal block 10 mm ²	DX25	1SAZ201307R0002	0.030
TA25DU-0.16 ... 25	Single mounting kit	DB25/25A	1SAZ201108R0001	0.055
TA25DU-32	Single mounting kit	DB25/32A	1SAZ201108R0002	0.080

Remote tripping coil

TA25DU	24/48 V, 50/60 Hz	DS25-A-24	1SAZ201501R0001	0.050
TA25DU	110 V, 50/60Hz	DS25-A-110	1SAZ201501R0003	0.050
TA25DU	220/380 V, 50/60 Hz	DS25-A-220/380	1SAZ201501R0005	0.050
TA25DU	500 V, 50/60Hz	DS25-A-500	1SAZ201501R0006	0.050

The remote tripping coil is to be connected to auxiliary contact 95-96 of TA25DU. The coil is not suitable for Continuous operation. Impulse duration: maximum 0.2 seconds.

Remote reset coil

TA25DU	24 V, 50/60 Hz	DR25-A-24	1SAZ201504R0001	0.050
TA25DU	48 V, 50/60 Hz	DR25-A-48	1SAZ201504R0002	0.050
TA25DU	110 V, 50/60 Hz	DR25-A-110	1SAZ201504R0003	0.050
TA25DU	220/380 V, 50/60 Hz	DR25-A-220/380	1SAZ201504R0005	0.050
TA25DU	500 V, 50/60 Hz	DR25-A-500	1SAZ201504R0006	0.050

The remote reset coil is to be connected to auxiliary contact 97-98 of TA25DU. The coil is not suitable for Continuous operation. Impulse duration: maximum 0.2 seconds.

Main dimensions mm, inches

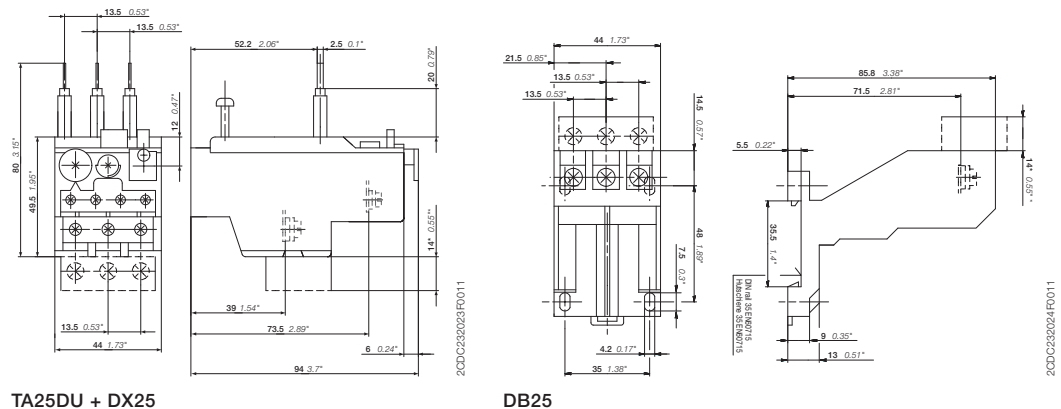

TA42DU thermal overload relays

18.0 ... 42.0 A

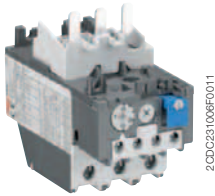

TA42DU-32

2CDC231006F0011

Description

The TA42DU thermal overload relays are economic electromechanical protection devices for the main circuit. They offer reliable protection for motors in the event of overload or phase failure. The devices have trip class 10A.

The thermal overload relays are three pole relays with bimetal tripping elements. The motor current flows through the bimetal tripping elements and heats them directly and indirectly. In case of an overload (over current), the bimetal elements bent as a result of the heating. This leads to a release of the relay and a change of the contacts switching position (95-96 / 97-98).

- Manual or automatic reset selectable
- Phase loss sensitive acc. to IEC/EN 60947-4-1
- Two electrically isolated auxiliary contacts – 1 N.O. + 1 N.C.
- TEST and STOP function – Trip indication on the front
- Temperature compensation
- Suitable for three- and single-phase applications

Ordering details

Setting range	Short-circuit protective device	Trip class	Type	Order code	Weight (1 pce) kg
A					
18 ... 25	63 A, Fuse type gG / 50 A aM	10A	TA42DU-25	1SAZ311201R1001	0.335
22 ... 32	80 A, Fuse type gG / 63 A aM	10A	TA42DU-32	1SAZ311201R1002	0.335
29 ... 42	100 A, Fuse type gG / 80 A aM	10A	TA42DU-42	1SAZ311201R1003	0.335

Ordering details accessories

For thermal overload relays	Description	Type	Order code	Weight (1 pce) kg
TA42DU	Single mounting kit	DB80	1SAZ301110R0001	0.155

Main dimensions mm, inches

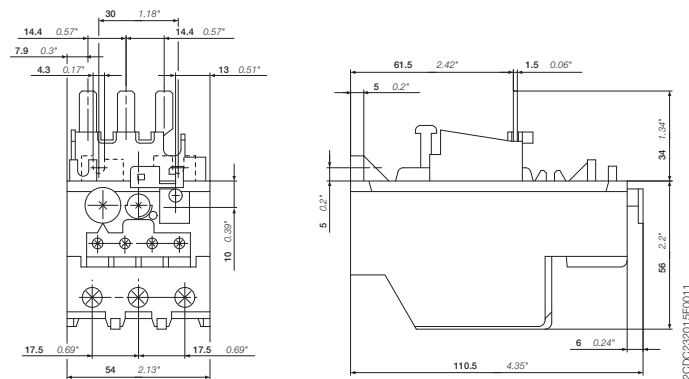

TA42DU

2CDC232015F0011

TA42DU thermal overload relays

Technical data

Main circuit – Utilization characteristics according to IEC/EN

Type	TA42DU
Standards	IEC 60947-1 / 60947-4-1 and EN 60947-1 / 60947-4-1
Rated operational voltage U_e	690 V AC
Rated frequency	DC, 50/60 Hz
Trip class	10A
Number of poles	3
Duty time	100 %
Operating frequency without early tripping	Up to 15 operations/h, see "Technical diagram – Intermittent periodic duty"
Rated impulse withstand voltage U_{imp}	6 kV
Rated insulation voltage U_i	690 V AC

Auxiliary circuit according to IEC/EN

Type	TA42DU
Rated operational voltage U_e	500 V AC, 440 V DC
Conventional free air thermal current I_{th}	N.C., 95-96 10 A N.O., 97-98 6 A
Rated frequency	DC, 50/60 Hz
Number of poles	1 N.O. + 1 N.C.
I_e / Rated operational current AC-15 acc. to IEC/EN 60947-5-1 for utilization category	
110-120 V	N.C., 95-96 3.00 A N.O., 97-98 3.00 A
220-230-240 V	N.C., 95-96 3.00 A N.O., 97-98 3.00 A
440 V	N.C., 95-96 1.90 A N.O., 97-98 1.00 A
480-500 V	N.C., 95-96 1.00 A N.O., 97-98 1.00 A
I_e / Rated operational current DC-13 acc. to IEC/EN 60947-5-1 for utilization category	
24 V	N.C., 95-96 1.25 A N.O., 97-98 1.25 A
60 V	N.C., 95-96 0.25 A N.O., 97-98 0.25 A
110-120-125 V	N.C., 95-96 0.25 A N.O., 97-98 0.25 A
250 V	N.C., 95-96 0.12 A N.O., 97-98 0.04 A
Minimum switching capacity	17 V / 3 mA
Short-circuit protective device	N.C., 95-96 10 A, Fuse type gG N.O., 97-98 6 A, Fuse type gG
Rated impulse withstand voltage U_{imp}	6 kV
Rated insulation voltage U_i	690 V

Technical diagram – Intermittent periodic duty

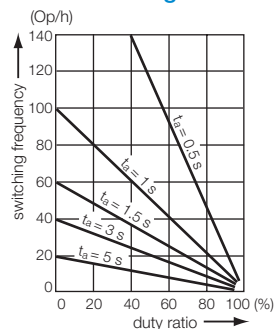

t_s : Motor starting time

TA42DU thermal overload relays

Technical data

Main circuit – Utilization characteristics according to UL/CSA

Type	TA42DU
Standards	UL 508, CSA 22.2 No. 14
Maximum operational voltage	600 V AC
Trip rating	125 % of FLA
Full load amps (FLA)	See table "Full load amps and short-circuit protective device"
Short-circuit rating RMS symmetrical	See table "Full load amps and short-circuit protective device"
Short-circuit protective device	See table "Full load amps and short-circuit protective device"

Auxiliary circuit according to UL/CSA

Type	TA42DU
Contact rating	N.C., 95-96 C600 N.O., 97-98 B600
Conventional thermal current	5 A

Full load amps and short-circuit protective device

Type	Full load amps (FLA)	Short-circuit protective device						
		480 / 600 V AC		Listed circuit breaker		Listed circuit breaker		
		Short circuit rating RMS symmetrical	Fuse type	Listed circuit breaker	Short circuit rating RMS symmetrical	Listed circuit breaker	Short circuit rating RMS symmetrical	Fuse type
TA42DU-25	25 A	5 kA	80 A, K5/ RK5	80 A	35 / 18 kA	80 A	50 kA	100 A, Class J
TA42DU-32	32 A	5 kA	100 A, K5/ RK5	80 A	35 / 18 kA	80 A	50 kA	100 A, Class J
TA42DU-42	42 A	5 kA	150 A, K5/ RK5	80 A	35 / 18 kA	80 A	50 kA	200 A, Class J

TA42DU thermal overload relays

Technical data



General technical data

Type	TA42DU	
Pollution degree	3	
Phase loss sensitive	Yes	
Ambient air temperature		
Operation	Open - compensated without derating	-25 ... +55 °C
	Open	-25 ... +55 °C
Storage	-40 ... +70 °C	
Ambient air temperature compensation	Continuous	
Maximum operating altitude permissible	2000 m	
Resistance to shock acc. to IEC 60068-2-27	12 g / 15 ms	
Mounting position	Position 1-6	
Mounting	Mount on the contactor and tighten the screws of the main circuit terminals or with single mounting kit on DIN rail (35 mm)	
Degree of protection	IP20	





Electrical connection

6

Main circuit

Type	TA42DU	
Connecting capacity		
 Rigid	1 x	2.5 ... 25 mm ²
	2 x	2.5 ... 16 mm ²
 Flexible with insulated ferrule	1 x	2.5 ... 25 mm ²
	2 x	2.5 ... 10 mm ²
	1 x or 2 x	AWG 8-1
Stranded acc. to UL/CSA	1 x or 2 x	AWG 8-1
Flexible acc. to UL/CSA	1 x or 2 x	AWG 8-1
Stripping length	14 mm	
Tightening torques	4.5 Nm / 40 lb.in	
Connection screw	M6 (Pozi driv 2)	

Auxiliary circuit

Type	TA42DU	
Connecting capacity		
 Rigid	1 x or 2 x	0.75 ... 4 mm ²
 Flexible with ferrule	1 x or 2 x	0.75 ... 2.5 mm ²
 Flexible with insulated ferrule	1 x or 2 x	0.75 ... 2.5 mm ²
 Flexible	1 x or 2 x	0.75 ... 2.5 mm ²
	1 x or 2 x	AWG 18-14
Stranded acc. to UL/CSA	1 x or 2 x	AWG 18-14
Flexible acc. to UL/CSA	1 x or 2 x	AWG 18-14
Stripping length	9 mm	
Tightening torques	0.8 ... 1.3 Nm / 12 lb.in	
Connection screw	M3.5 (Pozi driv 2)	

TA75DU thermal overload relays

18 ... 80 A

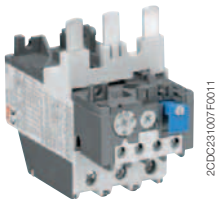

TA75DU-63

2CDC231007F0011

Description

The TA75DU thermal overload relays are economic electromechanical protection devices for the main circuit. They offer reliable protection for motors in the event of overload or phase failure. The devices have trip class 10A.

The thermal overload relays are three pole relays with bimetal tripping elements. The motor current flows through the bimetal tripping elements and heats them directly and indirectly. In case of an overload (over current), the bimetal elements bent as a result of the heating. This leads to a release of the relay and a change of the contacts switching position (95-96 / 97-98).

- Manual or automatic reset selectable
- Phase loss sensitive acc. to IEC/EN 60947-4-1
- Two electrically isolated auxiliary contacts – 1 N.O. + 1 N.C.
- TEST and STOP function – Trip indication on the front
- Temperature compensation
- Suitable for three- and single-phase applications

Ordering details

Setting range	Short-circuit protective device	Trip class	Type	Order code	Weight (1 pce) kg
A					
18 ... 25	63 A, Fuse type gG / 50 A aM	10A	TA75DU-25	1SAZ321201R1001	0.335
22 ... 32	80 A, Fuse type gG / 63 A aM	10A	TA75DU-32	1SAZ321201R1002	0.335
29 ... 42	100 A, Fuse type gG / 80 A aM	10A	TA75DU-42	1SAZ321201R1003	0.335
36 ... 52	125 A, Fuse type gG / 100 A aM	10A	TA75DU-52	1SAZ321201R1004	0.335
45 ... 63	160 A, Fuse type gG / 125 A aM	10A	TA75DU-63	1SAZ321201R1005	0.335
60 ... 80	200 A, Fuse type gG / 160 A aM	10A	TA75DU-80	1SAZ321201R1006	0.370

Ordering details accessories

For thermal overload relays	Description	Type	Order code	Weight (1 pce) kg
TA75DU	Single mounting kit	DB80	1SAZ301110R0001	0.155

Main dimensions mm, inches

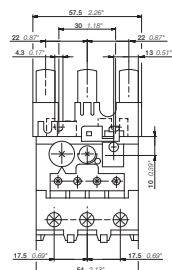

TA75DU

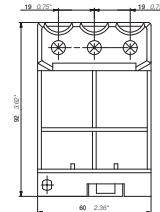
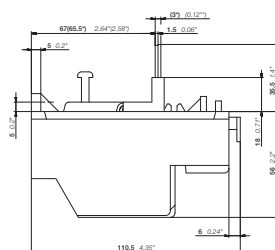

DB80

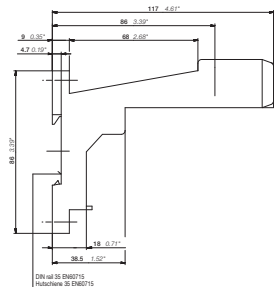

2CDC232025F0011
2CDC106043C0201

TA75DU thermal overload relays

Technical data

Main circuit – Utilization characteristics according to IEC/EN

Type	TA75DU
Standards	IEC 60947-1 / 60947-4-1 and EN 60947-1 / 60947-4-1
Rated operational voltage U_e	690 V AC
Rated frequency	DC, 50/60 Hz
Trip class	10A
Number of poles	3
Duty time	100 %
Operating frequency without early tripping	Up to 15 operations/h, see "Technical diagram – Intermittent periodic duty"
Rated impulse withstand voltage U_{imp}	6 kV
Rated insulation voltage U_i	690 V AC

Auxiliary circuit according to IEC/EN

Type	TA75DU
Rated operational voltage U_e	500 V AC, 440 V DC
Conventional free air thermal current I_{th}	N.C., 95-96 10 A N.O., 97-98 6 A
Rated frequency	DC, 50/60 Hz
Number of poles	1 N.O. + 1 N.C.
I_e / Rated operational current AC-15 acc. to IEC/EN 60947-5-1 for utilization category	
110-120 V	N.C., 95-96 3.00 A N.O., 97-98 3.00 A
220-230-240 V	N.C., 95-96 3.00 A N.O., 97-98 3.00 A
440 V	N.C., 95-96 1.90 A N.O., 97-98 1.00 A
480-500 V	N.C., 95-96 1.00 A N.O., 97-98 1.00 A
I_e / Rated operational current DC-13 acc. to IEC/EN 60947-5-1 for utilization category	
24 V	N.C., 95-96 1.25 A N.O., 97-98 1.25 A
60 V	N.C., 95-96 0.25 A N.O., 97-98 0.25 A
110-120-125 V	N.C., 95-96 0.25 A N.O., 97-98 0.25 A
250 V	N.C., 95-96 0.12 A N.O., 97-98 0.04 A
Minimum switching capacity	17 V / 3 mA
Short-circuit protective device	N.C., 95-96 10 A, Fuse type gG N.O., 97-98 6 A, Fuse type gG
Rated impulse withstand voltage U_{imp}	6 kV
Rated insulation voltage U_i	690 V

Technical diagram – Intermittent periodic duty

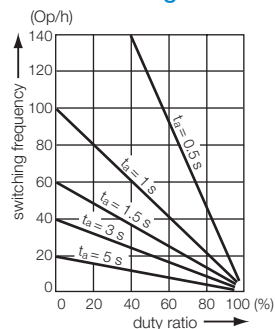

t_s : Motor starting time

TA75DU thermal overload relays

Technical data

Main circuit – Utilization characteristics according to UL/CSA

Type	TA75DU
Standards	UL 508, CSA 22.2 No. 14
Maximum operational voltage	600 V AC
Trip rating	125 % of FLA
Full load amps (FLA)	See table "Full load amps and short-circuit protective device"
Short-circuit rating RMS symmetrical	See table "Full load amps and short-circuit protective device"
Short-circuit protective device	See table "Full load amps and short-circuit protective device"

Auxiliary circuit according to UL/CSA

Type	TA75DU
Contact rating	N.C., 95-96 C600 N.O., 97-98 B600
Conventional thermal current	5 A

Full load amps and short-circuit protective device

Type	Full load amps (FLA)	Short-circuit protective device		
		480 / 600 V AC		Listed circuit breaker
		Short circuit rating RMS symmetrical	Fuse type	
TA75DU-25	25 A	5 kA	80 A, K5 / RK5	80 A
TA75DU-32	32 A	5 kA	100 A, K5 / RK5	80 A
TA75DU-42	42 A	5 kA	150 A, K5 / RK5	80 A
TA75DU-52	52 A	5 kA	175 A, K5 / RK5	125 A
TA75DU-63	63 A	10 kA	200 A, K5 / RK5	125 A
TA75DU-80	80 A	10 kA	250 A, K5 / RK5	125 A

TA75DU thermal overload relays

Technical data



General technical data

Type	TA75DU	
Pollution degree	3	
Phase loss sensitive	Yes	
Ambient air temperature		
Operation	Open - compensated without derating	-25 ... +55 °C
	Open	-25 ... +55 °C
Storage	-40 ... +70 °C	
Ambient air temperature compensation	Continuous	
Maximum operating altitude permissible	2000 m	
Resistance to shock acc. to IEC 60068-2-27	12 g / 15 ms	
Mounting position	Position 1-6	
Mounting	Mount on the contactor and tighten the screws of the main circuit terminals or with single mounting kit on DIN rail (35 mm)	
Degree of protection	IP20	





Electrical connection

6

Main circuit

Type	TA75DU	
Connecting capacity		
 Rigid	1 x	2.5 ... 25 mm ²
	2 x	2.5 ... 16 mm ²
 Flexible with insulated ferrule	1 x	2.5 ... 25 mm ²
	2 x	2.5 ... 10 mm ²
	1 x or 2 x	AWG 8-1
Stranded acc. to UL/CSA	1 x or 2 x	AWG 8-1
Flexible acc. to UL/CSA	1 x or 2 x	AWG 8-1
Stripping length	14 mm	
Tightening torques	4.5 Nm / 40 lb.in	
Connection screw	M6 (Pozi driv 2)	

Auxiliary circuit

Type	TA75DU	
Connecting capacity		
 Rigid	1 x or 2 x	0.75 ... 4 mm ²
 Flexible with ferrule	1 x or 2 x	0.75 ... 2.5 mm ²
 Flexible with insulated ferrule	1 x or 2 x	0.75 ... 2.5 mm ²
 Flexible	1 x or 2 x	0.75 ... 2.5 mm ²
	1 x or 2 x	AWG 18-14
Stranded acc. to UL/CSA	1 x or 2 x	AWG 18-14
Flexible acc. to UL/CSA	1 x or 2 x	AWG 18-14
Stripping length	9 mm	
Tightening torques	0.8 ... 1.3 Nm / 12 lb.in	
Connection screw	M3.5 (Pozi driv 2)	

TA80DU thermal overload relays

29 ... 80 A

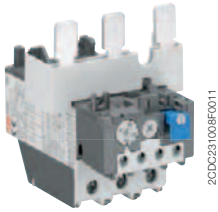

TA80DU-80

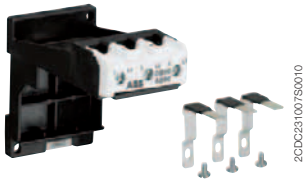

DB80

Description

The TA80DU thermal overload relays are economic electromechanical protection devices for the main circuit. They offer reliable protection for motors in the event of overload or phase failure. The devices have trip class 10A.

The thermal overload relays are three pole relays with bimetal tripping elements. The motor current flows through the bimetal tripping elements and heats them directly and indirectly. In case of an overload (over current), the bimetal elements bent as a result of the heating. This leads to a release of the relay and a change of the contacts switching position (95-96 / 97-98).

- Manual or automatic reset selectable
- Phase loss sensitive acc. to IEC/EN 60947-4-1
- Two electrically isolated auxiliary contacts – 1 N.O. + 1 N.C.
- TEST and STOP function – Trip indication on the front
- Temperature compensation
- Suitable for three- and single-phase applications

Ordering details

Setting range	Short-circuit protective device	Trip class	Type	Order code	Weight (1 pce) kg
A					
29 ... 42	100 A, Fuse type gG / 80 A aM	10A	TA80DU-42	1SAZ331201R1003	0.360
36 ... 52	125 A, Fuse type gG / 100 A aM	10A	TA80DU-52	1SAZ331201R1004	0.365
45 ... 63	160 A, Fuse type gG / 125 A aM	10A	TA80DU-63	1SAZ331201R1005	0.365
60 ... 80	200 A, Fuse type gG / 160 A aM	10A	TA80DU-80	1SAZ331201R1006	0.375

Ordering details accessories

For thermal overload relay	Description	Type	Order code	Weight (1 pce) kg
TA80DU	Single mounting kit	DB80	1SAZ301110R0001	0.155

Main dimensions mm, inches

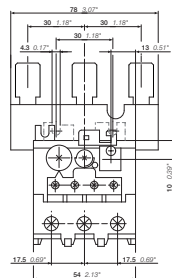

TA80DU

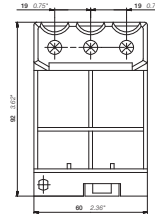
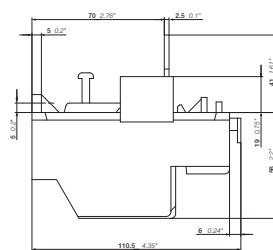

DB80

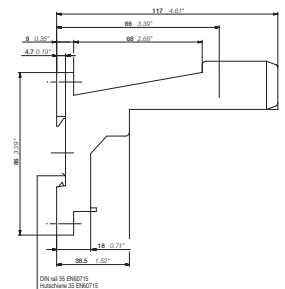

TA80DU thermal overload relays

Technical data

Main circuit – Utilization characteristics according to IEC/EN

Type	TA80DU
Standards	IEC 60947-1 / 60947-4-1 and EN 60947-1 / 60947-4-1
Rated operational voltage U_e	690 V AC
Rated frequency	DC, 50/60 Hz
Frequency range	0 ... 400 Hz
Trip class	10A
Number of poles	3
Duty time	100 %
Operating frequency without early tripping	Up to 15 operations/h, see "Technical diagram – Intermittent periodic duty"
Rated impulse withstand voltage U_{imp}	6 kV
Rated insulation voltage U_i	690 V AC

Auxiliary circuit according to IEC/EN

Type	TA80DU
Rated operational voltage U_e	500 V AC, 440 V DC
Conventional free air thermal current I_m	N.C., 95-96 10 A N.O., 97-98 6 A
Rated frequency	DC, 50/60 Hz
Number of poles	1 N.O. + 1 N.C.
I_e / Rated operational current AC-15 acc. to IEC/EN 60947-5-1 for utilization category	
110-120 V	N.C., 95-96 3.00 A N.O., 97-98 3.00 A
220-230-240 V	N.C., 95-96 3.00 A N.O., 97-98 3.00 A
440 V	N.C., 95-96 1.90 A N.O., 97-98 1.00 A
480-500 V	N.C., 95-96 1.00 A N.O., 97-98 1.00 A
I_e / Rated operational current DC-13 acc. to IEC/EN 60947-5-1 for utilization category	
24 V	N.C., 95-96 1.25 A N.O., 97-98 1.25 A
60 V	N.C., 95-96 0.25 A N.O., 97-98 0.25 A
110-120-125 V	N.C., 95-96 0.25 A N.O., 97-98 0.25 A
250 V	N.C., 95-96 0.12 A N.O., 97-98 0.04 A
Minimum switching capacity	17 V / 3 mA
Short-circuit protective device	N.C., 95-96 10 A, Fuse type gG N.O., 97-98 6 A, Fuse type gG
Rated impulse withstand voltage U_{imp}	6 kV
Rated insulation voltage U_i	690 V

Technical diagram – Intermittent periodic duty

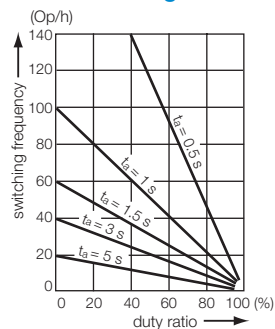

t_s : Motor starting time

2CDC32005F0211

2CDC10604C0201

TA80DU thermal overload relays

Technical data

Main circuit – Utilization characteristics according to UL/CSA

Type	TA80DU
Standards	UL 508, CSA 22.2 No. 14
Maximum operational voltage	600 V AC
Trip rating	125 % of FLA
Full load amps (FLA)	See table "Full load amps and short-circuit protective device"
Short-circuit rating RMS symmetrical	See table "Full load amps and short-circuit protective device"
Short-circuit protective device	See table "Full load amps and short-circuit protective device"

Auxiliary circuit according to UL/CSA

Type	TA80DU
Contact rating	N.C., 95-96 C600 N.O., 97-98 B600
Conventional thermal current	5 A

Full load amps and short-circuit protective device

Type	Full load amps (FLA)	Short-circuit protective device		
		480 / 600 V AC	Fuse type	Listed circuit breaker
TA80DU-42	42 A	5 kA	150 A, K5 / RK5	80 A
TA80DU-52	52 A	5 kA	175 A, K5 / RK5	125 A
TA80DU-63	63 A	10 kA	200 A, K5 / RK5	125 A
TA80DU-80	80 A	10 kA	250 A, K5 / RK5	125 A

TA80DU thermal overload relays

Technical data



General technical data

Type	TA80DU	
Pollution degree	3	
Phase loss sensitive	Yes	
Ambient air temperature		
Operation	Open - compensated without derating	-25 ... +55 °C
	Open	-25 ... +55 °C
Storage	-40 ... +70 °C	
Ambient air temperature compensation	Continuous	
Maximum operating altitude permissible	2000 m	
Resistance to shock acc. to IEC 60068-2-27	12 g / 15 ms	
Mounting position	Position 1-6	
Mounting	Mount on the contactor and tighten the screws of the main circuit terminals or with single mounting kit on DIN rail (35 mm)	
Degree of protection	IP20	





Electrical connection

6

Main circuit

Type	TA80DU	
Connecting capacity		
 Rigid	1 x	2.5 ... 25 mm ²
	2 x	2.5 ... 16 mm ²
 Flexible with insulated ferrule	1 x	2.5 ... 25 mm ²
	2 x	2.5 ... 10 mm ²
	1 x or 2 x	AWG 8-1
Stranded acc. to UL/CSA	1 x or 2 x	AWG 8-1
Flexible acc. to UL/CSA	1 x or 2 x	AWG 8-1
Stripping length	14 mm	
Tightening torques	4.5 Nm / 40 lb.in	
Connection screw	M6 (Pozi driv 2)	

Auxiliary circuit

Type	TA80DU	
Connecting capacity		
 Rigid	1 x or 2 x	0.75 ... 4 mm ²
 Flexible with ferrule	1 x or 2 x	0.75 ... 2.5 mm ²
 Flexible with insulated ferrule	1 x or 2 x	0.75 ... 2.5 mm ²
 Flexible	1 x or 2 x	0.75 ... 2.5 mm ²
	1 x or 2 x	AWG 18-14
Stranded acc. to UL/CSA	1 x or 2 x	AWG 18-14
Flexible acc. to UL/CSA	1 x or 2 x	AWG 18-14
Stripping length	9 mm	
Tightening torques	0.8 ... 1.3 Nm / 12 lb.in	
Connection screw	M3.5 (Pozi driv 2)	

TA110DU thermal overload relays

66 ... 110 A



TA110DU-110

2CDC31009F0011

Description

The TA110DU thermal overload relays are economic electromechanical protection devices for the main circuit. They offer reliable protection for motors in the event of overload or phase failure. The devices have trip class 10A.

The thermal overload relays are three pole relays with bimetal tripping elements. The motor current flows through the bimetal tripping elements and heats them directly and indirectly. In case of an overload (over current), the bimetal elements bent as a result of the heating. This leads to a release of the relay and a change of the contacts switching position (95-96 / 97-98).

- Manual or automatic reset selectable
- Phase loss sensitive acc. to IEC/EN 60947-4-1
- Two electrically isolated auxiliary contacts – 1 N.O. + 1 N.C.
- TEST and STOP function – Trip indication on the front
- Temperature compensation
- Suitable for three- and single-phase applications

Ordering details

Setting range	Short-circuit protective device	Trip class	Type	Order code	Weight (1 pce) kg
A					
66 ... 90	200 A, Fuse type gG / 160 A aM	10A	TA110DU-90	1SAZ411201R1001	0.750
80 ... 110	224 A, Fuse type gG / 200 A aM	10A	TA110DU-110	1SAZ411201R1002	0.755

Ordering details accessories

For thermal overload relays	Description	Type	Order code	Weight (1 pce) kg
TA110DU	Single mounting kit	DB200	1SAZ401110R0001	0.225

Main dimensions mm, inches

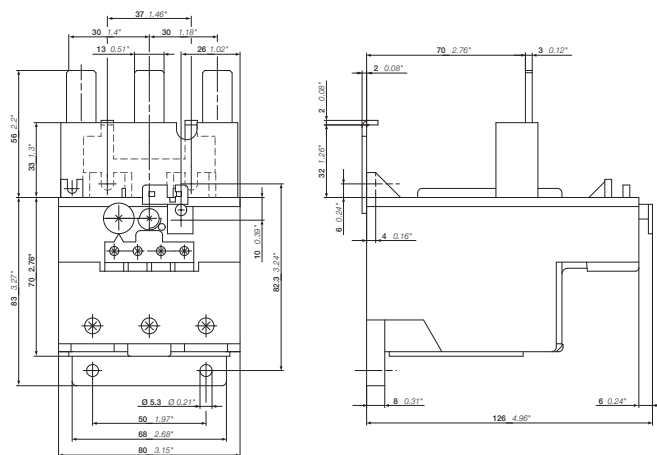

TA110DU

2CDC31009F0011

2CDC106037C0201

TA110DU thermal overload relays

Technical data

Main circuit – Utilization characteristics according to IEC/EN

Type	TA110DU
Standards	IEC 60947-1 / 60947-4-1 and EN 60947-1 / 60947-4-1
Rated operational voltage U_e	690 V AC
Rated frequency	DC, 50/60 Hz
Frequency range	0 ... 400 Hz
Trip class	10A
Number of poles	3
Duty time	100 %
Operating frequency without early tripping	Up to 15 operations/h, see "Technical diagram – Intermittent periodic duty"
Rated impulse withstand voltage U_{imp}	6 kV
Rated insulation voltage U_i	690 V AC

Auxiliary circuit according to IEC/EN

Type	TA110DU
Rated operational voltage U_e	500 V AC, 440 V DC
Conventional free air thermal current I_m	N.C., 95-96 10 A N.O., 97-98 6 A
Rated frequency	DC, 50/60 Hz
Number of poles	1 N.O. + 1 N.C.
I_e / Rated operational current AC-15 acc. to IEC/EN 60947-5-1 for utilization category	
110-120 V	N.C., 95-96 3.00 A N.O., 97-98 3.00 A
220-230-240 V	N.C., 95-96 3.00 A N.O., 97-98 3.00 A
440 V	N.C., 95-96 1.90 A N.O., 97-98 1.00 A
480-500 V	N.C., 95-96 1.00 A N.O., 97-98 1.00 A
I_e / Rated operational current DC-13 acc. to IEC/EN 60947-5-1 for utilization category	
24 V	N.C., 95-96 1.25 A N.O., 97-98 1.25 A
60 V	N.C., 95-96 0.25 A N.O., 97-98 0.25 A
110-120-125 V	N.C., 95-96 0.25 A N.O., 97-98 0.25 A
250 V	N.C., 95-96 0.12 A N.O., 97-98 0.04 A
Minimum switching capacity	17 V / 3 mA
Short-circuit protective device	N.C., 95-96 10 A, Fuse type gG N.O., 97-98 6 A, Fuse type gG
Rated impulse withstand voltage U_{imp}	6 kV
Rated insulation voltage U_i	690 V

Technical diagram – Intermittent periodic duty

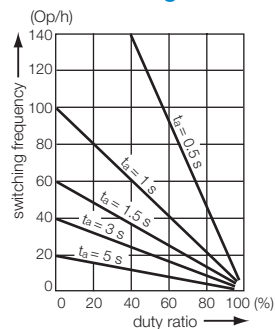

t_s : Motor starting time

2CDC32005F0211

2CDC106037C0201

TA110DU thermal overload relays

Technical data

Main circuit – Utilization characteristics according to UL/CSA

Type	TA110DU
Standards	UL 508, CSA 22.2 No. 14
Maximum operational voltage	600 V AC
Trip rating	125 % of FLA
Full load amps (FLA)	See table "Full load amps and short-circuit protective device"
Short-circuit rating RMS symmetrical	See table "Full load amps and short-circuit protective device"
Short-circuit protective device	See table "Full load amps and short-circuit protective device"

Auxiliary circuit according to UL/CSA

Type	TA110DU
Contact rating	N.C., 95-96 C600 N.O., 97-98 B600
Conventional thermal current	5 A

Full load amps and short-circuit protective device

Type	Full load amps (FLA)	Short-circuit protective device						
		480 / 600 V AC		Listed circuit breaker		Fused		Listed circuit breaker
		Short circuit rating RMS symmetrical	Fuse type	Listed circuit breaker	Short circuit rating RMS symmetrical	Fuse type	Short circuit rating RMS symmetrical	Listed circuit breaker
TA110DU-90	90 A	10 kA	250 A, K5 / RK5	150 A	65 kA	200 A, Class J	65 / 25 kA	150 A
TA110DU-110	110 A	10 kA	250 A, K5 / RK5	250 A	65 kA	200 A, Class J	65 / 25 kA	150 A

TA110DU thermal overload relays

Technical data



General technical data

Type	TA110DU	
Pollution degree	3	
Phase loss sensitive	Yes	
Ambient air temperature		
Operation	Open - compensated without derating	-25 ... +55 °C
	Open	-25 ... +55 °C
Storage	-40 ... +70 °C	
Ambient air temperature compensation	Continuous	
Maximum operating altitude permissible	2000 m	
Resistance to shock acc. to IEC 60068-2-27	12 g / 15 ms	
Mounting position	Position 1-6	
Mounting	Mount on the contactor and tighten the screws of the main circuit terminals or with single mounting kit	
Degree of protection	IP20	





Electrical connection

6

Main circuit

Type	TA110DU	
Connecting capacity		
 Rigid	1 x	16 ... 35 mm ²
	2 x	-
 Flexible	1 x	16 ... 35 mm ²
	2 x	-
	1 x or 2 x	AWG 6-2/0
Stranded acc. to UL/CSA	1 x or 2 x	AWG 6-2/0
Flexible acc. to UL/CSA	1 x or 2 x	AWG 6-2/0
Stripping length	25 mm	
Tightening torques	7.2 ... 9.6 Nm / 40 lb.in	
Connection screw	M8 (Hexagon)	

Auxiliary circuit

Type	TA110DU	
Connecting capacity		
 Rigid	1 x or 2 x	0.75 ... 4 mm ²
 Flexible with ferrule	1 x or 2 x	0.75 ... 2.5 mm ²
 Flexible with insulated ferrule	1 x or 2 x	0.75 ... 2.5 mm ²
 Flexible	1 x or 2 x	0.75 ... 2.5 mm ²
	1 x or 2 x	AWG 18-14
Stranded acc. to UL/CSA	1 x or 2 x	AWG 18-14
Flexible acc. to UL/CSA	1 x or 2 x	AWG 18-14
Stripping length	9 mm	
Tightening torques	0.8 ... 1.3 Nm / 12 lb.in	
Connection screw	M3.5 (Pozi driv 2)	

TA200DU thermal overload relays

66 ... 200 A



TA200DU-200

2CDC331010F0011

Description

The TA200DU thermal overload relays are economic electromechanical protection devices for the main circuit. They offer reliable protection for motors in the event of overload or phase failure. The devices have trip class 10A.

The thermal overload relays are three pole relays with bimetal tripping elements. The motor current flows through the bimetal tripping elements and heats them directly and indirectly. In case of an overload (over current), the bimetal elements bent as a result of the heating. This leads to a release of the relay and a change of the contacts switching position (95-96 / 97-98).

- Manual or automatic reset selectable
- Phase loss sensitive acc. to IEC/EN 60947-4-1
- Two electrically isolated auxiliary contacts – 1 N.O. + 1 N.C.
- TEST and STOP function – Trip indication on the front
- Temperature compensation
- Suitable for three- and single-phase applications

Ordering details

Setting range	Short-circuit protective device	Trip class	Type	Order code	Weight (1 pce) kg
A					
66 ... 90	200 A, Fuse type gG / 160 A aM	10A	TA200DU-90	1SAZ421201R1001	0.755
80 ... 110	224 A, Fuse type gG / 200 A aM	10A	TA200DU-110	1SAZ421201R1002	0.760
100 ... 135	224 A, Fuse type gG / 200 A aM	10A	TA200DU-135	1SAZ421201R1003	0.760
110 ... 150	250 A, Fuse type gG / 224 A aM	10A	TA200DU-150	1SAZ421201R1004	0.760
130 ... 175	315 A, Fuse type gG / 250 A aM	10A	TA200DU-175	1SAZ421201R1005	0.770
150 ... 200	315 A, Fuse type gG / 250 A aM	10A	TA200DU-200	1SAZ421201R1006	0.785

Ordering details accessories

For thermal overload relays	Description	Type	Order code	Weight (1 pce) kg
TA200DU	Terminal shroud	LT200/A	1SAZ401901R1001	0.090
TA200DU	Single mounting kit	DB200	1SAZ401110R0001	0.225

Main dimensions mm, inches

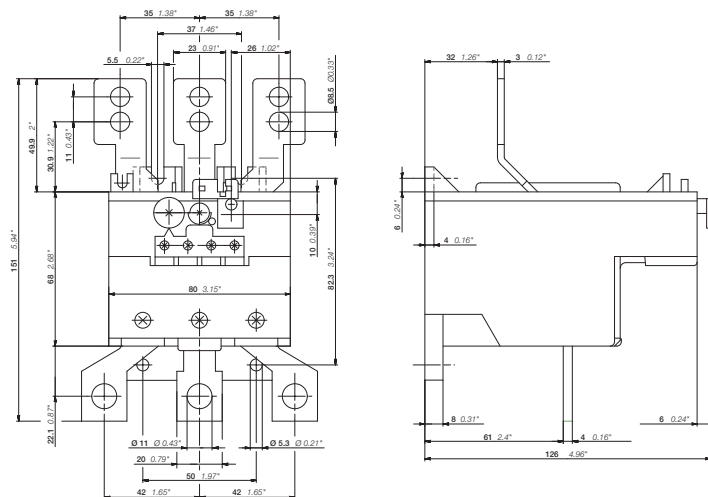

TA200DU

2CDC332021F0011

2CDC106038C0201

TA200DU thermal overload relays

Technical data

Main circuit – Utilization characteristics according to IEC/EN

Type	TA200DU
Standards	IEC 60947-1 / 60947-4-1 and EN 60947-1 / 60947-4-1
Rated operational voltage U_e	690 V AC
Rated frequency	DC, 50/60 Hz
Frequency range	0 ... 400 Hz
Trip class	10A
Number of poles	3
Duty time	100 %
Operating frequency without early tripping	Up to 15 operations/h, see "Technical diagram – Intermittent periodic duty"
Rated impulse withstand voltage U_{imp}	6 kV
Rated insulation voltage U_i	690 V AC

Auxiliary circuit according to IEC/EN

Type	TA200DU
Rated operational voltage U_e	500 V AC, 440 V DC
Conventional free air thermal current I_m	N.C., 95-96 10 A N.O., 97-98 6 A
Rated frequency	DC, 50/60 Hz
Number of poles	1 N.O. + 1 N.C.
I_e / Rated operational current AC-15 acc. to IEC/EN 60947-5-1 for utilization category	
110-120 V	N.C., 95-96 3.00 A N.O., 97-98 3.00 A
220-230-240 V	N.C., 95-96 3.00 A N.O., 97-98 3.00 A
440 V	N.C., 95-96 1.90 A N.O., 97-98 1.00 A
480-500 V	N.C., 95-96 1.00 A N.O., 97-98 1.00 A
I_e / Rated operational current DC-13 acc. to IEC/EN 60947-5-1 for utilization category	
24 V	N.C., 95-96 1.25 A N.O., 97-98 1.25 A
60 V	N.C., 95-96 0.25 A N.O., 97-98 0.25 A
110-120-125 V	N.C., 95-96 0.25 A N.O., 97-98 0.25 A
250 V	N.C., 95-96 0.12 A N.O., 97-98 0.04 A
Minimum switching capacity	17 V / 3 mA
Short-circuit protective device	N.C., 95-96 10 A, Fuse type gG N.O., 97-98 6 A, Fuse type gG
Rated impulse withstand voltage U_{imp}	6 kV
Rated insulation voltage U_i	690 V

Technical diagram – Intermittent periodic duty

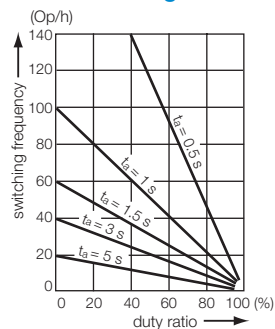

t_s : Motor starting time

2CDC32005F0211

2CDC106038C0201

TA200DU thermal overload relays

Technical data

Main circuit – Utilization characteristics according to UL/CSA

Type	TA200DU
Standards	UL 508, CSA 22.2 No. 14
Maximum operational voltage	600 V AC
Trip rating	125 % of FLA
Full load amps (FLA)	See table "Full load amps and short-circuit protective device"
Short-circuit rating RMS symmetrical	See table "Full load amps and short-circuit protective device"
Short-circuit protective device	See table "Full load amps and short-circuit protective device"

Auxiliary circuit according to UL/CSA

Type	TA200DU
Contact rating	N.C., 95-96 C600 N.O., 97-98 B600
Conventional thermal current	5 A

Full load amps and short-circuit protective device

Type	Full load amps (FLA)	Short-circuit protective device							
		480 / 600 V AC		Listed circuit breaker		Fuse type		Listed circuit breaker	
		Short circuit rating RMS symmetrical	Fuse type	Listed circuit breaker	Short circuit rating RMS symmetrical	Fuse type	Short circuit rating RMS symmetrical	Listed circuit breaker	
TA200DU-90	90 A	10 kA	250 A, K5 / RK5	225 A	-	-	-	-	
TA200DU-110	110 A	10 kA	250 A, K5 / RK5	225 A	-	-	18 kA	125 A	
TA200DU-135	135 A	10 kA	300 A, K5 / RK5	225 A	50 kA	400 A, Class J	35 / 18 kA	225 A	
TA200DU-150	150 A	10 kA	300 A, K5 / RK5	225 A	65 kA	400 A, Class J	35 / 18 kA	225 A	
TA200DU-175	175 A	10 kA	300 A, K5 / RK5	225 A	65 kA	400 A, Class J	35 / 18 kA	225 A	
TA200DU-200	200 A	10 kA	400 A, K5 / RK5	400 A	65 kA	400 A, Class J	35 / 18 kA	225 A	

TA200DU thermal overload relays

Technical data



General technical data

Type	TA200DU	
Pollution degree	3	
Phase loss sensitive	Yes	
Ambient air temperature		
Operation	Open - compensated without derating	-25 ... +55 °C
	Open	-25 ... +55 °C
Storage	-40 ... +70 °C	
Ambient air temperature compensation	Continuous	
Maximum operating altitude permissible	2000 m	
Resistance to shock acc. to IEC 60068-2-27	12 g / 15 ms	
Mounting position	Position 1-6	
Mounting	Mount on the contactor and tighten the screws of the main circuit terminals or with single mounting kit	
Degree of protection	IP20	





Electrical connection

6

Main circuit

Type	TA200DU	
Connecting capacity		
 Rigid	1 x	25 ... 120 mm ²
 Flexible	1 x	16 ... 35 mm ²
 Lugs	L ≤ 12 mm / l > 6 mm	
Tightening torques	4 Nm	
Connection screw	M6	

Auxiliary circuit

Type	TA200DU	
Connecting capacity		
 Rigid	1 x or 2 x	0.75 ... 4 mm ²
 Flexible with ferrule	1 x or 2 x	0.75 ... 2.5 mm ²
 Flexible with insulated ferrule	1 x or 2 x	0.75 ... 2.5 mm ²
 Flexible	1 x or 2 x	0.75 ... 2.5 mm ²
Stranded acc. to UL/CSA	1 x or 2 x	AWG 18-14
Flexible acc. to UL/CSA	1 x or 2 x	AWG 18-14
Stripping length	9 mm	
Tightening torques	0.8 ... 1.3 Nm / 12 lb.in	
Connection screw	M3.5 (Pozidriv 2)	

TA450DU thermal overload relays

130 ... 310 A

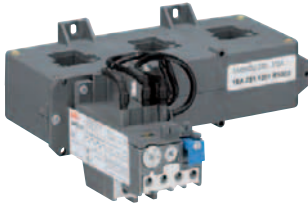

TA450DU-310

2CDC23101F0011

Description

The TA450DU thermal overload relays are economic electromechanical protection devices for the main circuit. They offer reliable protection for motors in the event of overload or phase failure. The devices have trip class 10A.

The thermal overload relays are three pole relays with bimetal tripping elements. The motor current flows through the bimetal tripping elements and heats them directly and indirectly. In case of an overload (over current), the bimetal elements bent as a result of the heating. This leads to a release of the relay and a change of the contacts switching position (95-96 / 97-98).

- Manual or automatic reset selectable
- Phase loss sensitive acc. to IEC/EN 60947-4-1
- Two electrically isolated auxiliary contacts – 1 N.O. + 1 N.C.
- TEST and STOP function – Trip indication on the front
- Temperature compensation
- Suitable for three- and single-phase applications

Ordering details

Setting range	Short-circuit protective device	Trip class	Type	Order code	Weight (1 pce) kg
A					
130 ... 185	not applicable	10A	TA450DU-185	1SAZ511201R1001	1.500
165 ... 235	not applicable	10A	TA450DU-235	1SAZ511201R1002	1.500
220 ... 310	not applicable	10A	TA450DU-310	1SAZ511201R1003	1.500

Ordering details accessories

For thermal overload relays	Description	Type	Order code	Weight (1 pce) kg
TA450DU	Terminal shroud	DT450/A185	1SAZ501901R1001	1.070
TA450DU	Terminal shroud	DT450/A300	1SAZ501902R1001	1.180

Main dimensions mm, inches

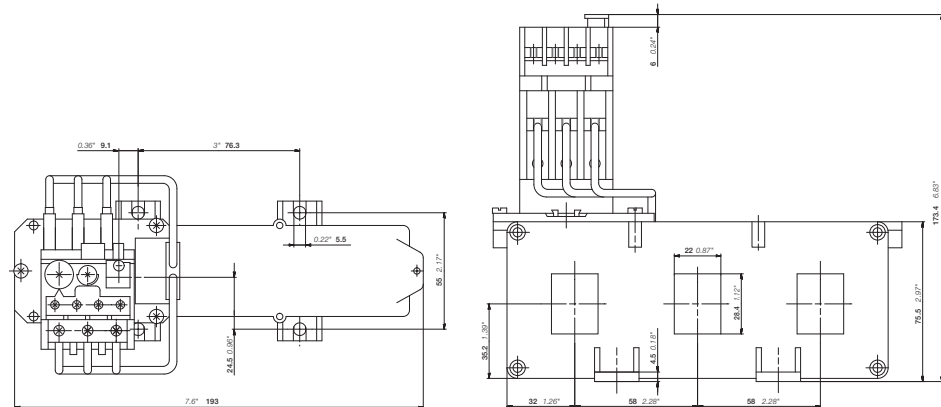

TA450DU

2CDC2310022F0011

2CDC106041C0201

TA450DU thermal overload relays

Technical data

Main circuit – Utilization characteristics according to IEC/EN

Type	TA450DU
Standards	IEC 60947-1 / 60947-4-1 and EN 60947-1 / 60947-4-1
Rated operational voltage U_e	1000 V AC
Rated frequency	50/60 Hz
Trip class	10A
Number of poles	3
Duty time	100 %
Operating frequency without early tripping	Up to 15 operations/h, see "Technical diagram – Intermittent periodic duty"
Rated impulse withstand voltage U_{imp}	8 kV
Rated insulation voltage U_i	1000 V AC

Auxiliary circuit according to IEC/EN

Type	TA450DU
Rated operational voltage U_e	500 V AC, 440 V DC
Conventional free air thermal current I_{th}	N.C., 95-96 10 A N.O., 97-98 6 A
Rated frequency	DC, 50/60 Hz
Number of poles	1 N.O. + 1 N.C.
I_e / Rated operational current AC-15 acc. to IEC/EN 60947-5-1 for utilization category	
110-120 V	N.C., 95-96 3.00 A N.O., 97-98 3.00 A
220-230-240 V	N.C., 95-96 3.00 A N.O., 97-98 3.00 A
440 V	N.C., 95-96 1.90 A N.O., 97-98 1.00 A
480-500 V	N.C., 95-96 1.00 A N.O., 97-98 1.00 A
I_e / Rated operational current DC-13 acc. to IEC/EN 60947-5-1 for utilization category	
24 V	N.C., 95-96 1.25 A N.O., 97-98 1.25 A
60 V	N.C., 95-96 0.25 A N.O., 97-98 0.25 A
110-120-125 V	N.C., 95-96 0.25 A N.O., 97-98 0.25 A
250 V	N.C., 95-96 0.12 A N.O., 97-98 0.04 A
Minimum switching capacity	17 V / 3 mA
Short-circuit protective device	N.C., 95-96 10 A, Fuse type gG N.O., 97-98 6 A, Fuse type gG
Rated impulse withstand voltage U_{imp}	6 kV
Rated insulation voltage U_i	500 V

Technical diagram – Intermittent periodic duty

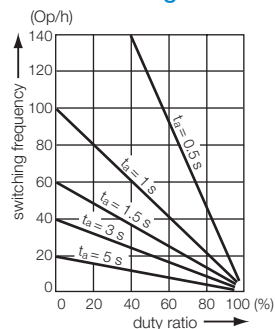

t_s : Motor starting time

TA450DU thermal overload relays

Technical data

Main circuit – Utilization characteristics according to UL/CSA

Type	TA450DU
Standards	UL 508, CSA 22.2 No. 14
Maximum operational voltage	600 V AC
Trip rating	125 % of FLA
Full load amps (FLA)	See table "Full load amps and short-circuit protective device"
Short-circuit rating RMS symmetrical	See table "Full load amps and short-circuit protective device"
Short-circuit protective device	See table "Full load amps and short-circuit protective device"

Auxiliary circuit according to UL/CSA

Type	TA450DU
Contact rating	N.C., 95-96 C600 N.O., 97-98 B600
Conventional thermal current	5 A

Full load amps and short-circuit protective device

Type	Full load amps (FLA)	Short-circuit protective device		
		480 / 600 V AC Short circuit rating RMS symmetrical	Fuse type	Listed circuit breaker
TA450DU-185	185 A	10 kA	na	na
TA450DU-235	235 A	10 kA	na	na
TA450DU-310	310 A	18 kA	na	na

TA450DU thermal overload relays

Technical data

General technical data





Type	TA450DU	
Pollution degree	3	
Phase loss sensitive	Yes	
Ambient air temperature		
Operation	Open - compensated without derating	-25 ... +55 °C
Storage	Open	-25 ... +55 °C
Storage		-40 ... +70 °C
Ambient air temperature compensation	Continuous	
Maximum operating altitude permissible	2000 m	
Resistance to shock acc. to IEC 60068-2-27	12 g / 15 ms	
Mounting position	Position 1-6	
Degree of protection	IP20	

Electrical connection

Main circuit

Type	TA450DU	
Connecting capacity		
Bar	Max. 21 x 28.4 mm	

Auxiliary circuit

Type	TA450DU	
Connecting capacity		
 Rigid	1 x or 2 x	0.75 ... 4 mm ²
 Flexible with ferrule	1 x or 2 x	0.75 ... 2.5 mm ²
 Flexible with insulated ferrule	1 x or 2 x	0.75 ... 2.5 mm ²
 Flexible	1 x or 2 x	0.75 ... 2.5 mm ²
Stranded acc. to UL/CSA	1 x or 2 x	AWG 18-14
Flexible acc. to UL/CSA	1 x or 2 x	AWG 18-14
Stripping length	9 mm	
Tightening torques	0.8 ... 1.3 Nm / 12 lb.in	
Connection screw	M3.5 (Pozidriv 2)	

E16DU, E45DU, E80DU, E140DU electronic overload relays 0.10 to 140 A



E16DU-1.0



E45DU-30



E80DU-80



E140DU-140

Description

The E16DU up to E140DU are self-supplied electronic overload relays, which means no extra external supply is needed. It offers reliable protection for motors in the event of overload or phase failure. Easy to use like a thermal overload relay and compatible with standard motor applications, the electronic overload relay is convincing, above all, due to its wide setting range, high accuracy, high operational temperature range and the possibility to select a trip class (10E, 20E, 30E). Further features are the temperature compensation, trip contact (N.C.), signal contact (N.O.), automatic or manual reset selectable, trip-free mechanism, STOP and TEST function and a trip indication. The overload relays are connected directly to the contactors. Single mounting kits are available as accessory.

Ordering details

Setting range	Short-circuit protective device	Trip class	Type	Order code	Weight (1 pce) kg
A					
E16DU electronic overload relays					
0.10 ... 0.32	1 A, Fuse type gG	10E, 20E, 30E	E16DU-0.32	1SAX111001R1101	0.150
0.30 ... 1.00	4 A, Fuse type gG	10E, 20E, 30E	E16DU-1.0	1SAX111001R1102	0.150
0.80 ... 2.70	10 A, Fuse type gG	10E, 20E, 30E	E16DU-2.7	1SAX111001R1103	0.150
1.90 ... 6.30	20 A, Fuse type gG	10E, 20E, 30E	E16DU-6.3	1SAX111001R1104	0.150
5.70 ... 18.9	50 A, Fuse type gG	10E, 20E, 30E	E16DU-18.9	1SAX111001R1105	0.150
E45DU electronic overload relays					
9.00 ... 30.0	160 A, Fuse type gG	10E, 20E, 30E	E45DU-30	1SAX211001R1101	0.350
15.0 ... 45.0	160 A, Fuse type gG	10E, 20E, 30E	E45DU-45	1SAX211001R1102	0.350
E80DU electronic overload relay					
27.0 ... 80.0 A	250 A	10E, 20E, 30E	E80DU-80	1SAX311001R1101	0.770
E140DU electronic overload relay					
50.0 ... 140.0 A	400 A	10E, 20E, 30E	E140DU-140	1SAX321001R1101	0.915

Main dimensions mm, inches

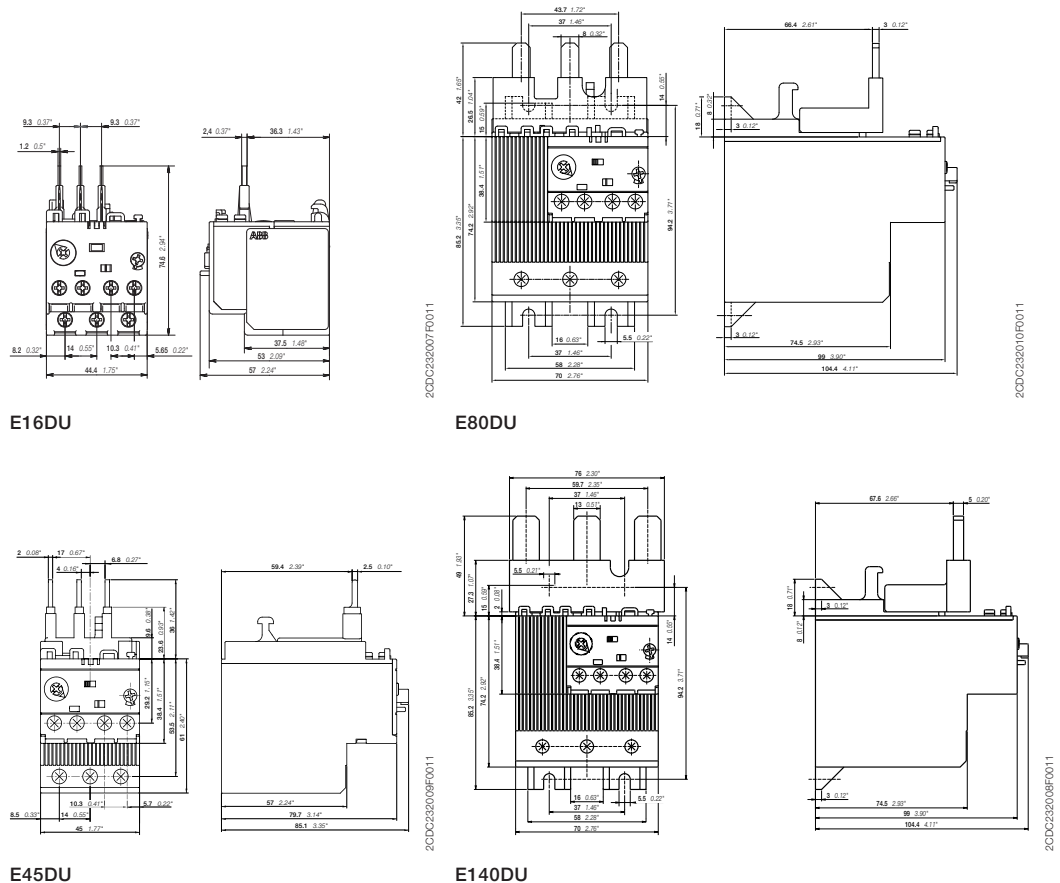

E16DU, E45DU, E80DU, E140DU electronic overload relays

Technical data

Main circuit – Utilization characteristics according to IEC/EN

Type	E16DU	E45DU	E80DU	E140DU
Standards	IEC 60947-1 / 60947-4-1 / 60947-5-1 and EN 60947-1 / 60947-4-1 / 60947-5-1			
Rated operational voltage U_e	690 V AC		1000 V AC	
Rated frequency	50/60 Hz			
Trip class	10E, 20E, 30E, selectable			
Number of poles	3			
Duty time	100 %			
Operating frequency without early tripping	Up to 15 operations/h, see "Technical diagram – Intermittent periodic duty"			
Rated impulse withstand voltage U_{imp}	6 kV			
Rated insulation voltage U_i	690 V AC		1000 V AC	

Auxiliary circuit according to IEC/EN

Type	E16DU	E45DU	E80DU	E140DU
Rated operational voltage U_e	600 V AC / DC			
Conventional free air thermal current I_m	6 A			
Rated frequency	DC, 50/60 Hz			
Number of poles	1 N.C. + 1 N.O.			
I_e / Rated operational current AC-15 acc. to IEC/EN 60947-5-1 for utilization category				
110-120 V	50/60 Hz	3.00 A		
220-230-240 V	50/60 Hz	3.00 A		
440 V	50/60 Hz	1.10 A		
480-500 V	50/60 Hz	0.72 A		
I_e / Rated operational current DC-13 acc. to IEC/EN 60947-5-1 for utilization category				
24 V		1.50 A		
60 V		0.55 A		
110-120-125 V		0.55 A		
250 V		0.27 A		
Minimum switching capacity	12 V / 3 mA			
Short-circuit protective device	6 A, Fuse type gG			
Rated impulse withstand voltage U_{imp}	6 kV			
Rated insulation voltage U_i	690 V			

Technical diagram – Intermittent periodic duty

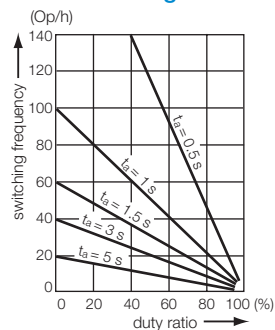

t_s : Motor starting time

E16DU, E45DU, E80DU, E140DU electronic overload relays

Technical data

Main circuit – Utilization characteristics according to UL/CSA

Type	E16DU	E45DU	E80DU	E140DU
Standards	UL 508, CSA 22.2, No. 14			
Maximum operational voltage	600 V AC			
Trip rating	125 % of FLA			
Full load amps (FLA)	See table "Full load amps and short-circuit protective device"			
Short-circuit rating RMS symmetrical	See table "Full load amps and short-circuit protective device"			
Short-circuit protective device	See table "Full load amps and short-circuit protective device"			

Auxiliary circuit according to UL/CSA

Type	E16DU	E45DU	E80DU	E140DU
Contact rating	B600, Q300			
Conventional thermal current	5 A			

Full load amps and short-circuit protective device

Type	Full load amps (FLA)	Short-circuit protective device					
		480 V AC		600 V AC			
		SCCR	Fuse type	SCCR	Fuse type	SCCR	Fuse type
E16DU-0.32	0.32 A	50 kA	2 A, Class J	5 kA	2 A, K5 / RK5	100 kA	2 A, Class J
E16DU-1.0	1.00 A	50 kA	2 A, K5 / RK5	5 kA	2 A, K5 / RK5	100 kA	2 A, Class J
E16DU-2.7	2.70 A	50 kA	4 A, K5 / RK5	5 kA	4 A, K5 / RK5	100 kA	4 A, Class J
E16DU-6.3	6.30 A	50 kA	15 A, K5 / RK5	5 kA	15 A, K5 / RK5	100 kA	15 A, Class J
E16DU-18.9	18.90 A	50 kA	30 A, K5 / RK5	5 kA	30 A, K5 / RK5	100 kA	30 A, Class J

Type	Full load amps (FLA)	Short-circuit protective device			
		600 V AC			
		SCCR	Fuse type	SCCR	Fuse type
E45DU-30	30 A	18 kA	150 A, K5 / RK5	100 kA	150 A, Class J
E45DU-45	45 A	18 kA	200 A, K5 / RK5	100 kA	200 A, Class J

Type	Full load amps (FLA)	Short-circuit protective device	
		600 V AC	
		SCCR	Fuse type
E80DU-80	80 A	18 kA	300 A, K5 / RK5

Type	Full load amps (FLA)	Short-circuit protective device	
		600 V AC	
		SCCR	Fuse type
E140DU-140	140 A	18 kA	400 A, K5 / RK5

E16DU, E45DU, E80DU, E140DU electronic overload relays



Technical data

General data





Type	E16DU	E45DU	E80DU	E140DU
Pollution degree	3			
Phase loss sensitive	Yes			
Ambient air temperature				
Operation	Open - compensated without derating			
Storage		-25 ... +70 °C		
Ambient air temperature compensation		-50 ... +85 °C		
Ambient air temperature compensation		Continuous		
Maximum operating altitude permissible		2000 m		
Resistance to shock acc. to IEC 60068-2-27		15 g / 11 ms		
Resistance to vibrations acc. to IEC 60068-2-6		5 g / 3 ... 150 Hz		
Mounting position		Position 1-6		
Mounting		Mount on the contactor and tighten the screws of the main circuit terminals or with single mounting kit		
Degree of protection		IP20		

6 Electrical connection

Main circuit

Type	E16DU	E45DU	E80DU	E140DU
Connecting capacity				
 Rigid	1 x 1 ... 4 mm ² 2 x 1 ... 4 mm ²	2.5 ... 16 mm ² 2.5 ... 16 mm ²	6 ... 95 mm ² 6 ... 35 mm ²	6 ... 95 mm ² 6 ... 35 mm ²
 Flexible with insulated ferrule	1 x 0.75 ... 2.5 mm ² 2 x 0.75 ... 2.5 mm ²	2.5 ... 10 mm ² 2.5 ... 10 mm ²	6 ... 70 mm ² 6 ... 35 mm ²	6 ... 70 mm ² 6 ... 35 mm ²
Stranded acc. to UL/CSA	1 x AWG 16-10 2 x AWG 16-10	AWG 14-6 AWG 14-6	AWG 10-0 -	AWG 8-0 -
Flexible acc. to UL/CSA	1 x AWG 16-10 2 x AWG 16-10	AWG 14-6 AWG 14-6	AWG 10-0 -	AWG 8-0 -
Stripping length	9 mm	13 mm	-	-
Tightening torques	0.8 - 1.5 Nm / 7 lb.in	2.3 - 2.6 Nm / 22 lb.in	6 - 6.5 Nm / 53 lb.in	6 - 6.5 Nm / 53 lb.in
Connection screw	M3.5 (Pozidriv 2)	M5 (Pozidriv 2)	M8 (inbus 4)	M8 (inbus 4)

Auxiliary circuit

Type	E16DU	E45DU	E80DU	E140DU
Connecting capacity				
 Rigid	1 or 2 x 1 ... 4 mm ²			
 Flexible with ferrule	1 or 2 x 0.75 ... 2.5 mm ²			
 Flexible with insulated ferrule	1 or 2 x 0.75 ... 2.5 mm ²			
 Flexible	1 or 2 x 0.75 ... 2.5 mm ²			
Stranded acc. to UL/CSA	1 or 2 x AWG 16-10			
Flexible acc. to UL/CSA	1 or 2 x AWG 16-10			
Stripping length	9 mm			
Tightening torques	0.8 ... 1.2 Nm / 7 lb.in			
Connection screw	M3.5 (Pozidriv 2)			

E16DU, E45DU, E80DU, E140DU electronic overload relays

Accessories



2CDC231003RF0010

DB16E



2CDC231004RF0010

DB45E



2CDC231005RF0010

DB80E



2CDC231006RF0010

DB140E

Description

Single mounting kits are available as accessory for E16DU, E45DU, E80DU, and E140DU. The single mounting kits offer the possibility to mount the overload relay separately from the contactor.

Ordering details

For electronic overload relays	Description	Type	Order code	Weight (1 pce) kg
Single mounting kits				
E16DU	Single mounting kit	DB16E	1SAX101110R0001	0.035
E45DU	Single mounting kit	DB45E	1SAX201110R1001	0.090
E80DU	Single mounting kit	DB80E	1SAX301110R1001	0.145
E140DU	Single mounting kit	DB140E	1SAX301110R1002	0.145

Main dimensions mm, inches

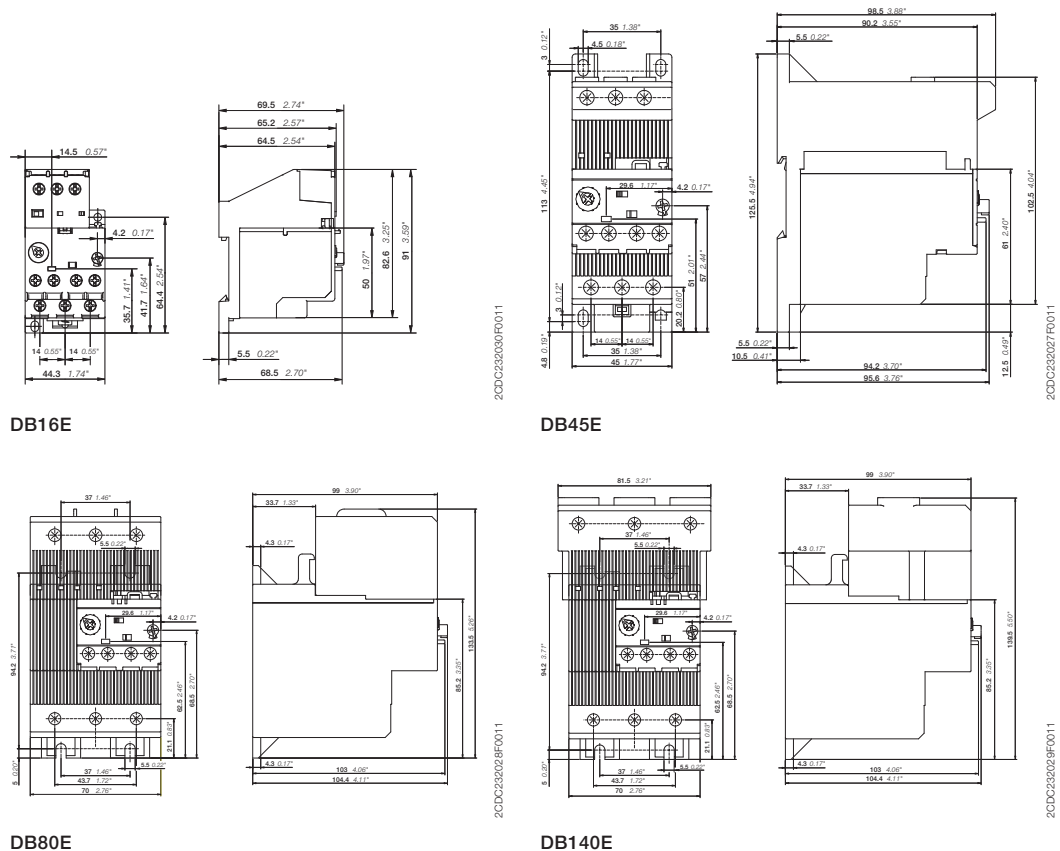

EF19, EF45 electronic overload relays

0.10 to 45.0 A



1SBC101147F0010

EF19-18.9



1SBC101148F0010

EF45-30

Description

The EF19 and EF45 are self-supplied electronic overload relays, which means no extra external supply is needed. It offers reliable protection for motors in the event of overload or phase failure. Easy to use like a thermal overload relay and compatible with standard motor applications, the electronic overload relay is convincing, above all, due to its wide setting range, high accuracy, high operational temperature range and the possibility to select a trip class (10E, 20E, 30E). Further features are the temperature compensation, trip contact (N.C.), signal contact (N.O.), automatic or manual reset selectable, trip-free mechanism, STOP and TEST function and a trip indication. The overload relays are connected directly to the contactors.

Ordering details

Setting range	Short-circuit protective device	Trip class	Type	Order code	Weight (1 pce) kg
A					
EF19 electronic overload relays					
0.10 ... 0.32	1 A, Fuse type gG	10E, 20E, 30E	EF19-0.32	1SAX121001R1101	0.158
0.30 ... 1.00	4 A, Fuse type gG	10E, 20E, 30E	EF19-1.0	1SAX121001R1102	0.158
0.80 ... 2.70	10 A, Fuse type gG	10E, 20E, 30E	EF19-2.7	1SAX121001R1103	0.158
1.90 ... 6.30	20 A, Fuse type gG	10E, 20E, 30E	EF19-6.3	1SAX121001R1104	0.158
5.70 ... 18.9	50 A, Fuse type gG	10E, 20E, 30E	EF19-18.9	1SAX121001R1105	0.158
EF45 electronic overload relays					
9.00 ... 30.0	160 A, Fuse type gG	10E, 20E, 30E	EF45-30	1SAX221001R1101	0.362
15.0 ... 45.0	160 A, Fuse type gG	10E, 20E, 30E	EF45-45	1SAX221001R1102	0.362

Main dimensions mm, inches

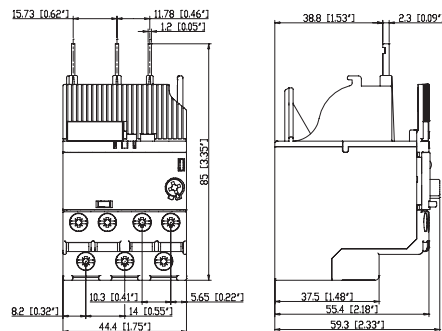

EF19

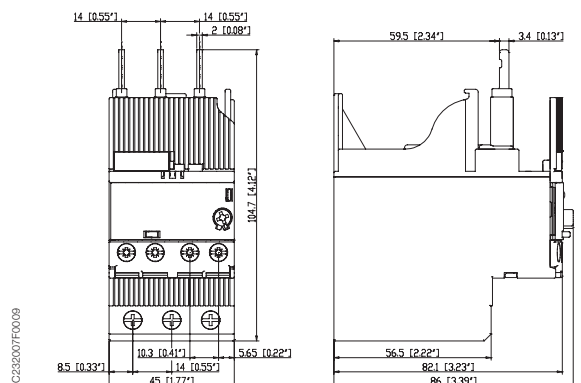

EF45

EF19, EF45 electronic overload relays

Technical data

Main circuit – Utilization characteristics according to IEC/EN

Type	EF19	EF45
Standards	IEC 60947-1 / 60947-4-1 / 60947-5-1 and EN 60947-1 / 60947-4-1 / 60947-5-1	
Rated operational voltage U_e	690 V AC	
Rated frequency	50/60 Hz	
Trip class	10E, 20E, 30E, selectable	
Number of poles	3	
Duty time	100 %	
Operating frequency without early tripping	Up to 15 operations/h, see "Technical diagram – Intermittent periodic duty"	
Rated impulse withstand voltage U_{imp}	6 kV	
Rated insulation voltage U_i	690 V AC	

Auxiliary circuit according to IEC/EN

Type	EF19	EF45
Rated operational voltage U_e	600 V AC / DC	
Conventional free air thermal current I_{th}	6 A	
Rated frequency	DC, 50/60 Hz	
Number of poles	1 N.C. + 1 N.O.	
I_e / Rated operational current AC-15 acc. to IEC/EN 60947-5-1 for utilization category		
110-120 V	50/60 Hz	3.00 A
220-230-240 V	50/60 Hz	3.00 A
440 V	50/60 Hz	1.10 A
480-500 V	50/60 Hz	0.75 A
I_e / Rated operational current DC-13 acc. to IEC/EN 60947-5-1 for utilization category		
24 V		1.50 A
60 V		0.55 A
110-120-125 V		0.55 A
250 V		0.27 A
Minimum switching capacity	12 V / 3 mA	
Short-circuit protective device	6 A, Fuse type gG	
Rated impulse withstand voltage U_{imp}	6 kV	
Rated insulation voltage U_i	690 V	

Technical diagram – Intermittent periodic duty

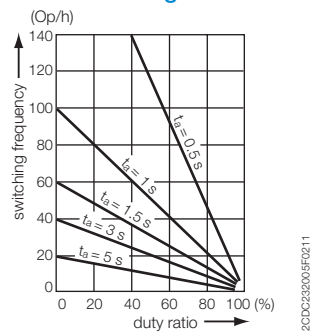

t_a : Motor starting time

EF19, EF45 electronic overload relays

Technical data

Main circuit – Utilization characteristics according to UL/CSA

Type	EF19	EF45
Standards	UL 508, CSA 22.2 No. 14	
Maximum operational voltage	600 V AC	
Trip rating	125 % of FLA	
Full load amps (FLA)	See table "Full load amps and short-circuit protective device"	
Short-circuit rating RMS symmetrical	See table "Full load amps and short-circuit protective device"	
Short-circuit protective device	See table "Full load amps and short-circuit protective device"	

Auxiliary circuit according to UL/CSA

Type	EF19	EF45
Contact rating	N.C., 95-96 N.O., 97-98	B600, Q600 B600, Q600
Conventional thermal current	5 A	

6

Full load amps and short-circuit protective device

Type	Full load amps (FLA)	Short-circuit protective device					
		480 V AC		600 V AC			
		SCCR	Fuse type	SCCR	Fuse type	SCCR	Fuse type
EF19-0.32	0.32 A	50 kA	2 A, Class J	5 kA	2 A, K5 / RK5	100 kA	2 A, Class J
EF19-1.0	1.00 A	50 kA	2 A, K5 / RK5	5 kA	2 A, K5 / RK5	100 kA	2 A, Class J
EF19-2.7	2.70 A	50 kA	4 A, K5 / RK5	5 kA	4 A, K5 / RK5	100 kA	4 A, Class J
EF19-6.3	6.30 A	50 kA	15 A, K5 / RK5	5 kA	15 A, K5 / RK5	100 kA	15 A, Class J
EF19-18.9	18.90 A	50 kA	30 A, K5 / RK5	5 kA	30 A, K5 / RK5	100 kA	30 A, Class J

Type	Full load amps (FLA)	Short-circuit protective device					
		480 V AC		600 V AC			
		SCCR	Fuse type	SCCR	Fuse type	SCCR	Fuse type
EF45-30	30 kA	18 kA	150 A, K5 / RK5	18 kA	150 A, K5 / RK5	100 kA	150 A, Class J
EF45-45	45 kA	18 kA	200 A, K5 / RK5	18 kA	200 A, K5 / RK5	100 kA	200 A, Class J

EF19, EF45 electronic overload relays



Technical data

General data





Type	EF19	EF45
Pollution degree	3	
Phase loss sensitive	Yes	
Ambient air temperature		
Operation	Open - compensated without derating	
Storage		
Ambient air temperature compensation	-25 ... +70 °C	
Maximum operating altitude permissible	-50 ... +85 °C	
Resistance to shock acc. to IEC 60068-2-27	Continuous	
Resistance to vibrations acc. to IEC 60068-2-6	2000 m	
Mounting position	15 g / 11 ms	
Mounting	1 g / 3 ... 150 Hz	
Degree of protection	Position 1-6	
	Mount on the contactor and tighten the screws of the main circuit terminals	
	IP20	

Electrical connection

Main circuit

Type	EF19	EF45
Connecting capacity		
 Rigid	1 or 2 x 1 ... 4 mm ²	2.5 ... 16 mm ²
 Flexible with insulated ferrule	1 or 2 x 0.75 ... 2.5 mm ²	2.5 ... 10 mm ²
Stranded acc. to UL/CSA	1 or 2 x AWG 16-10	AWG 14-6
Flexible acc. to UL/CSA	1 or 2 x AWG 16-10	AWG 14-6
Stripping length	9 mm	13 mm
Tightening torques	0.8 ... 1.5 Nm / 7 ... 13 lb.in	2.3 ... 2.6 Nm / 20 ... 22 lb.in
Connection screw	M3.5 (Pozidriv 2)	

Auxiliary circuit

Type	EF19	EF45
Connecting capacity		
 Rigid	1 or 2 x 1 ... 4 mm ²	
 Flexible with ferrule	1 or 2 x 0.75 ... 2.5 mm ²	
 Flexible with insulated ferrule	1 or 2 x 0.75 ... 2.5 mm ²	
 Flexible	1 or 2 x 0.75 ... 2.5 mm ²	
Stranded acc. to UL/CSA	1 or 2 x AWG 18-10	
Flexible acc. to UL/CSA	1 or 2 x AWG 18-10	
Stripping length	9 mm	
Tightening torques	0.8 ... 1.2 Nm / 7 ... 11 lb.in	
Connection screw	M3 (Pozidriv 2)	

E200DU, E320DU electronic overload relays

60 to 320 A



2CDC231001F0008

E200DU-200



2CDC231002F0008

E320DU-320

Description

The E200DU and E320DU are self-supplied electronic overload relays, which means no extra external supply is needed. It offers reliable protection for motors in the event of overload or phase failure. Easy to use like a thermal overload relay and compatible with standard motor applications, the electronic overload relay is convincing, above all, due to its wide setting range, high accuracy, high operational temperature range and the possibility to select a trip class (10E, 20E, 30E). Further features are the temperature compensation, trip contact (N.C.), signal contact (N.O.), automatic or manual reset selectable, trip-free mechanism, STOP and TEST function and a trip indication. The overload relays are connected directly to the contactors.

Ordering details

Setting range	Short-circuit protective device	Trip class	Type	Order code	Weight (1 pce) kg
A					

E200DU electronic overload relay

60.0 ... 200.0	800 A	10E, 20E, 30E	E200DU-200	1SAX511001R1101	1.210
----------------	-------	---------------	------------	-----------------	-------

E320DU electronic overload relay

100.0 ... 320.0	630 A	10E, 20E, 30E	E320DU-320	1SAX521001R1101	1.430
-----------------	-------	---------------	------------	-----------------	-------

Terminal shrouds for E200DU and E320DU electronic overload relay

For electronic overload relays	Description	Type	Order code	Weight (1 pce) kg
E200DU	LT200E Terminal shroud for E200DU	LT200E	1SAX501904R0001	0.085
E320DU	LT320E Terminal shroud for E320DU	LT320E	1SAX601904R0001	0.105

Main dimensions mm, inches

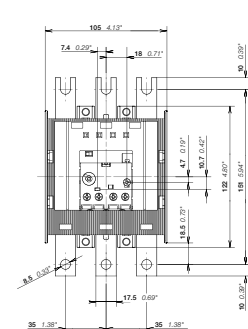

E200DU

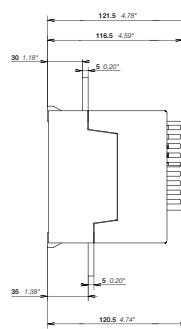

E320DU

E200DU, E320DU electronic overload relays

Technical data

Main circuit – Utilization characteristics according to IEC/EN

Type	E200DU	E320DU
Standards	IEC 60947-1 / 60947-4-1 / 60947-5-1 and EN 60947-1 / 60947-4-1 / 60947-5-1	
Rated operational voltage U_e	1000 V AC	
Rated frequency	50/60 Hz	
Trip class	10E, 20E, 30E, selectable	
Number of poles	3	
Duty time	100 %	
Operating frequency without early tripping	Up to 15 operations/h, see "Technical diagram – Intermittent periodic duty"	
Rated impulse withstand voltage U_{imp}	8 kV	
Rated insulation voltage U_i	1000 V AC	

Auxiliary circuit according to IEC/EN

Type	E16DU	E45DU
Rated operational voltage U_e	600 V AC / DC	
Conventional free air thermal current I_{th}	6 A	
Rated frequency	DC, 50/60 Hz	
Number of poles	1 N.C. + 1 N.O.	
I_e / Rated operational current AC-15 acc. to IEC/EN 60947-5-1 for utilization category		
110-120 V	50/60 Hz	3.00 A
220-230-240 V	50/60 Hz	3.00 A
440 V	50/60 Hz	1.10 A
480-500 V	50/60 Hz	0.72 A
I_e / Rated operational current DC-13 acc. to IEC/EN 60947-5-1 for utilization category		
24 V		1.50 A
60 V		0.55 A
110-120-125 V		0.55 A
250 V		0.27 A
Minimum switching capacity	12 V / 3 mA	
Short-circuit protective device	6 A, Fuse type gG	
Rated impulse withstand voltage U_{imp}	8 kV	
Rated insulation voltage U_i	690 V	

Technical diagram – Intermittent periodic duty

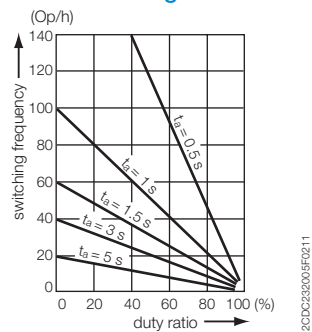

t_a : Motor starting time

E200DU, E320DU electronic overload relays

Technical data

Main circuit – Utilization characteristics according to UL/CSA

Type	E200DU	E320DU
Standards	UL 508, CSA 22.2 No. 14	
Maximum operational voltage	600 V AC	
Trip rating	125 % of FLA	

Auxiliary circuit according to UL/CSA





Type	E200DU	E320DU
Contact rating	N.C., 95-96	B600, Q300
	N.O., 97-98	B600, Q300
Conventional thermal current	5 A	

General data

Type	E200DU	E320DU
Pollution degree	3	
Phase loss sensitive	Yes	
Ambient air temperature		
Operation	Open - compensated without derating	-25 ... +70 °C
Storage		-50 ... +85 °C
Ambient air temperature compensation	Continuous	
Maximum operating altitude permissible	2000 m	
Resistance to shock acc. to IEC 60068-2-27	15 g / 11 ms	
Resistance to vibrations acc. to IEC 60068-2-6	5 g / 3 ... 150 Hz	
Mounting position	Position 1-6	
Mounting	Mount on the contactor and tighten the screws of the main circuit terminals	
Degree of protection	IP20	

Electrical connection

Auxiliary circuit

Type	E200DU	E320DU
Connecting capacity		
 Rigid	1 or 2 x	1 ... 4 mm ²
 Flexible with ferrule	1 or 2 x	0.75 ... 2.5 mm ²
 Flexible with insulated ferrule	1 or 2 x	0.75 ... 2.5 mm ²
 Flexible	1 or 2 x	0.75 ... 2.5 mm ²
	Stranded acc. to UL/CSA	1 or 2 x AWG 16-10
	Flexible acc. to UL/CSA	1 or 2 x AWG 16-10
Stripping length	9 mm	
Tightening torques	0.8 ... 1.2 Nm / 7 lb.in	
Connection screw	M3.5 (Pozi driv 2)	

E500DU, E800DU, E1250DU electronic overload relays 150 to 1250 A



E500DU-500

2CDC231003F0008

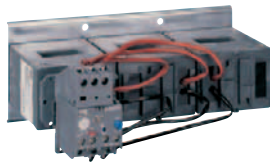

E800DU-800

2CDC231004F0008

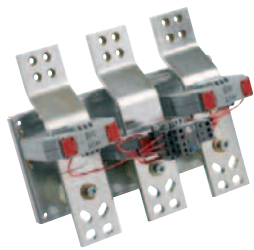

E1250DU-1250

1SFC101025F0201

Description

The E500DU up to E1250DU are self-supplied electronic overload relays, which means no extra external supply is needed. It offers reliable protection for motors in the event of overload or phase failure. Easy to use like a thermal overload relay and compatible with standard motor applications, the electronic overload relay is convincing, above all, due to its wide setting range, high accuracy, high operational temperature range and the possibility to select a trip class (10E, 20E, 30E). Further features are the temperature compensation, trip contact (N.C.), signal contact (N.O.), automatic or manual reset selectable, trip-free mechanism, STOP and TEST function and a trip indication. The overload relays are connected directly to the contactors. Busbar kits are available as accessory for contactor mounting.

Ordering details

Setting range	Short-circuit protective device	Trip class	Type	Order code	Weight (1 pce) kg
A					

E500DU electronic overload relay

150 ... 500	1000 A	10E, 20E, 30E	E500DU-500	1SAX711001R1101	1.170
-------------	--------	---------------	------------	-----------------	-------

E800DU electronic overload relay

250 ... 800	1250 A	10E, 20E, 30E	E800DU-800	1SAX811001R1101	3.905
-------------	--------	---------------	------------	-----------------	-------

E1250DU electronic overload relay

375 ... 1250	-	10E, 20E, 30E	E1250DU-1250	1SFA739001R1000	12.181
--------------	---	---------------	--------------	-----------------	--------

Terminal shrouds for E500DU and E800DU electronic overload relay

For electronic overload relays	Description	Type	Order code	Weight (1 pce) kg
E500DU	LT500E Terminal shroud for E500DU	LT500E	1SAX701904R0001	0.360
E800DU	LT800E Terminal shroud for E800DU	LT800E	1SAX801904R0001	0.105

Main dimensions mm, inches

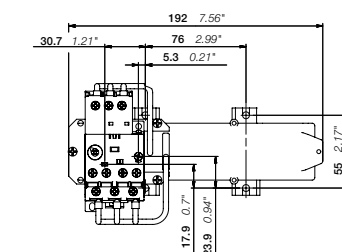
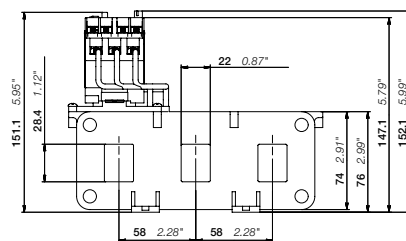

E500DU

2CDC232013F0011

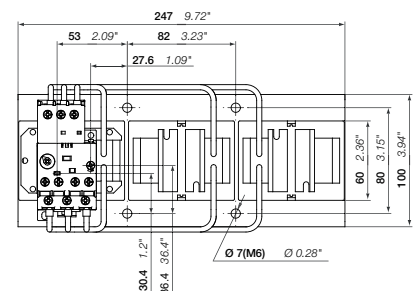
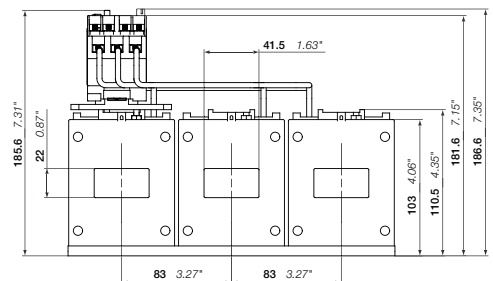

E800DU

2CDC232014F0011

2CDC107031C0201

E500DU, E800DU, E1250DU electronic overload relays

Technical data

Main circuit – Utilization characteristics according to IEC/EN

Type	E500DU	E800DU	E1250DU
Standards	IEC 60947-1 / 60947-4-1 / 60947-5-1 and EN 60947-1 / 60947-4-1 / 60947-5-1		
Rated operational voltage U_e	1000 V AC		
Rated frequency	50/60 Hz		
Trip class	10E, 20E, 30E, selectable		
Number of poles	3		
Duty time	100 %		
Operating frequency without early tripping	Up to 15 operations/h, see "Technical diagram – Intermittent periodic duty"		
Rated impulse withstand voltage U_{imp}	8 kV		
Rated insulation voltage U_i	1000 V AC		

Auxiliary circuit according to IEC/EN

Type	E500DU	E800DU	E1250DU
Rated operational voltage U_e	600 V AC / DC		
Conventional free air thermal current I_m	6 A		
Rated frequency	DC, 50/60 Hz		
Number of poles	1 N.C. + 1 N.O.		
I_e / Rated operational current AC-15 acc. to IEC/EN 60947-5-1 for utilization category			
110-120 V	50/60 Hz	3.00 A	
220-230-240 V	50/60 Hz	3.00 A	
440 V	50/60 Hz	1.10 A	
480-500 V	50/60 Hz	0.72 A	
I_e / Rated operational current DC-13 acc. to IEC/EN 60947-5-1 for utilization category			
24 V		1.50 A	
60 V		0.55 A	
110-120-125 V		0.55 A	
250 V		0.27 A	
Minimum switching capacity	12 V / 3 mA		
Short-circuit protective device	6 A, Fuse type gG		
Rated impulse withstand voltage U_{imp}	8 kV		
Rated insulation voltage U_i	690 V		

Technical diagram – Intermittent periodic duty

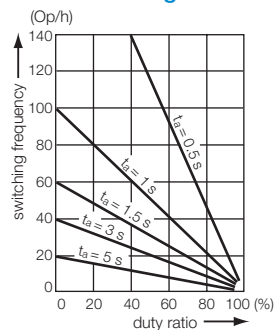

2CDC233005F0211

t_s : Motor starting time

E500DU, E800DU, E1250DU electronic overload relays

Technical data

Main circuit – Utilization characteristics according to UL/CSA

Type	E500DU	E800DU	E1250DU
Standards	UL 508, CSA 22.2 No. 14		
Maximum operational voltage	600 V AC		
Trip rating	125 % of FLA		

Auxiliary circuit according to UL/CSA





Type	E500DU	E800DU	E1250DU
Contact rating	N.C., 95-96 N.O., 97-98	B600, Q300	
Conventional thermal current	5 A		

General data

Type	E500DU	E800DU	E1250DU
Pollution degree	3		
Phase loss sensitive	Yes		
Ambient air temperature			
Operation	Open - compensated without derating		
Storage	-25 ... +70 °C		
Storage	-50 ... +85 °C		
Ambient air temperature compensation	Continuous		
Maximum operating altitude permissible	2000 m		
Resistance to shock acc. to IEC 60068-2-27	15 g / 11 ms		
Resistance to vibrations acc. to IEC 60068-2-6	5 g / 3 ... 150 Hz		
Degree of protection	IP20		

Electrical connection

Auxiliary circuit

Type	E500DU	E800DU	E1250DU
Connecting capacity			
 Rigid	1 or 2 x	1 ... 4 mm ²	
 Flexible with ferrule	1 or 2 x	0.75 ... 2.5 mm ²	
 Flexible with insulated ferrule	1 or 2 x	0.75 ... 2.5 mm ²	
 Flexible	1 or 2 x	0.75 ... 2.5 mm ²	
Stranded acc. to UL/CSA	1 or 2 x	AWG 16-10	
Flexible acc. to UL/CSA	1 or 2 x	AWG 16-10	
Stripping length	9 mm		
Tightening torques	0.8 ... 1.2 Nm / 7 lb.in		
Connection screw	M3.5 (Pozidriv 2)		

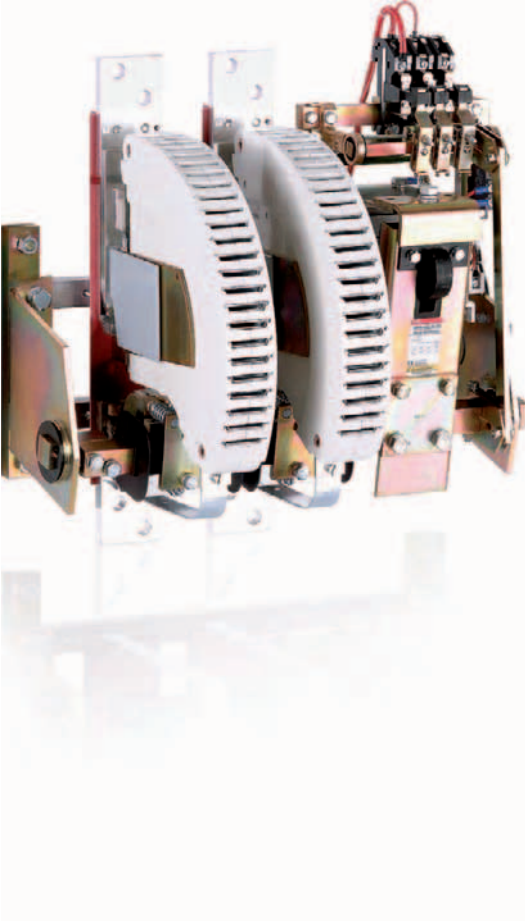

R contactors

[Presentation](#) 7/2

Overview

R contactors for the AC circuits switching 7/4

R contactors for the DC circuits switching 7/6

[Questionnaire](#) 7/8

R contactors

85 to 5000 A

R contactors with variable number of poles and their variants (contactors with N.C. + N.O. poles, couplers...) are used for controlling power circuits up to 1000 V AC or 1500 V DC. They are designed with common standard components. With the combination of these elements and the adaptation possibilities, special versions can be provided. Designed for long-lasting operation and demanding applications, the ABB R contactors are used for many applications all over the world.

Flexibility of design

- Variable number of poles
- Adjustable number of auxiliary contacts
- Optional combination of N.O. and N.C. poles
- Mechanical or magnetic latching available.

Easy maintenance

- Direct access to all the components of the contactor
- Complete and didactic instruction manual
- Spare parts available
- Dedicated service for bar contactors.

Exceptional durability

- Mechanical durability up to 10 millions operating cycles
- Mechanical switching frequency up to 1200 cycles per hour
- Electrical durability up to 350 000 operating cycles.

Ideal for heavy duty applications

- High making and breaking capacity
- Fully compatible with the requirements of utilization categories AC-3, DC-3 and DC-5 (control of AC / DC motors for mining, iron and steel industries...).

Custom-made solutions

- More than 60 years' experience in dealing with customers projects
- Development of solutions from specifications
- Pre-sales support to identify and define customer requirements
- Specialists available to help you, select your product or optimize your configuration.

7



R contactors

For heavy duty applications

R contactors meet the particular requirements of each AC / DC control application up to 5000 A, where the demands are increasing:

- Power distribution
- Photovoltaic, hydroelectric power stations
- Batteries
- Mining
- Railway networks and rolling stock
- Induction furnaces
- Pump stations
- Travelling cranes.



Control your AC applications up to 5000 A

AC-1 Rated operational current up to 5000 A

AC-3 Rated power up to 1500 kW (1520 A - 440 V)

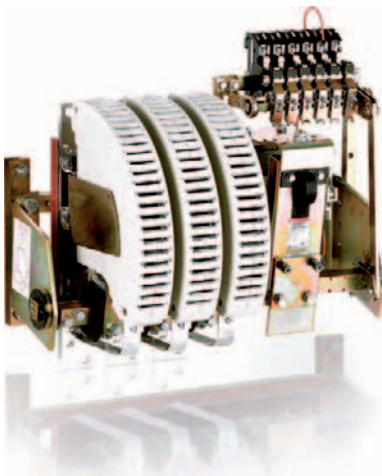

Control your DC applications up to 5000 A

DC-1 Rated operational current up to 5000 A

DC-3 / DC-5 Rated operational current up to 2000 A
1500 V with poles in series



Special applications

AC / DC coupling: LOR.. contactors

Slip ring motor control: FOR.. contactors

AC / DC switching (N.C. / N.O. main poles): NOR & JOR.. contactors

Latching contactors for energy saving and safety requirements: AMA or AME contactors

Field discharge: AM(F)-CC-JORE.. contactors

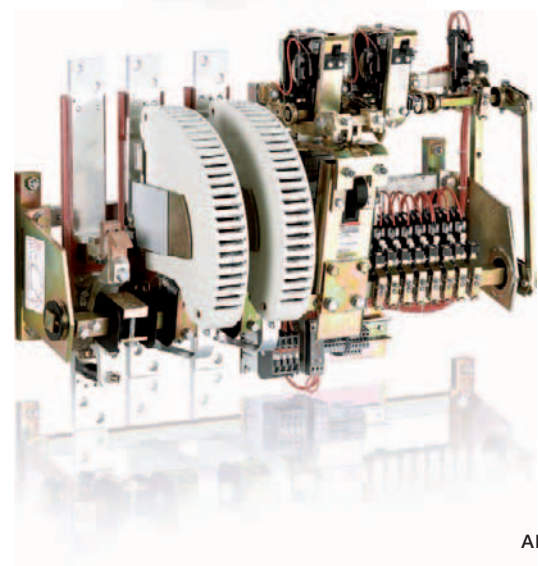

R contactors for the AC circuits switching

Voltage U_e up to **1000 V AC**
 Current I_e up to **4500 A**

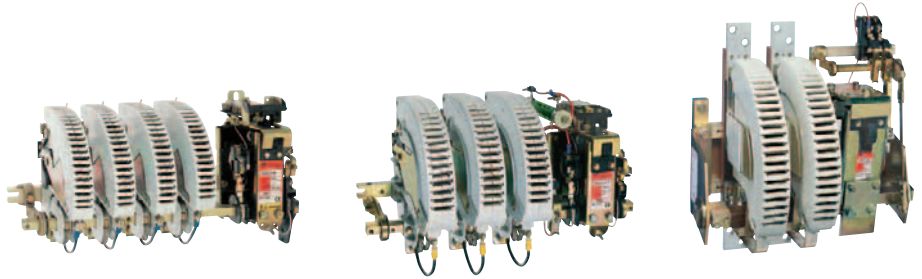

Contactor type	AC control circuit	~	IORR63..-MT	IORR125..-MT	IORR200..-MT	IORR400..-MT	IORR500..-MT	IORR800..-MT
	DC control circuit	≡	IORE63..-MT	IORE125..-MT	IORE200..-MT	IORE400..-MT	IORE500..-MT	IORE800..-MT
Categories	U_e							
AC-1	at 40 °C		I_e 85 A	170 A	260 A	400 A	550 A	800 A
AC-3	690 V AC		I_e 85 A	160 A	260 A	400 A	550 A	800 A
	1000 V AC max.		I_e 56 A	105 A	180 A	280 A	380 A	580 A
AC-3	690 V AC	Power	80 kW	150 kW	240 kW	400 kW	540 kW	780 kW

7

Voltage U_e up to **500 V AC**
 Current I_e up to **5000 A**

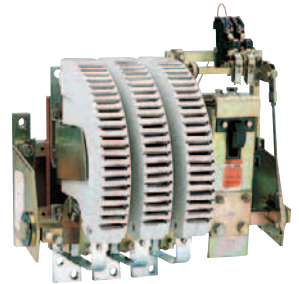

Contactor type	AC control circuit	~			IORR800
	DC control circuit	≡			IORE800
Categories	U_e				
AC-1	at 40 °C		I_e	From 85 A to 550 A, select above IOR...-MT	900 A
AC-3	380-415-440 V AC		I_e	–	800 A
	500 V AC max.		I_e	–	800 A
AC-3	400 V AC	Power		–	450 kW

Recap:

All contactors fulfill the IEC 60947-4-1 / EN 60947-4-1 standards.

Utilization category AC-1: max. breaking current = 1.5 x I_e ,
 max. making current = 1.5 x I_e .

Utilization category AC-3: max. breaking current = 8 x I_e ,
 max. making current = 10 x I_e .

Contactors with NC poles, magnetic or mechanical latching devices on request.

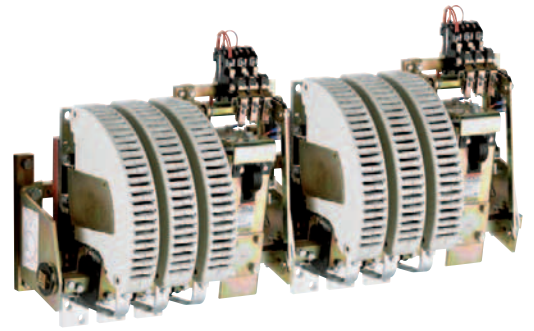
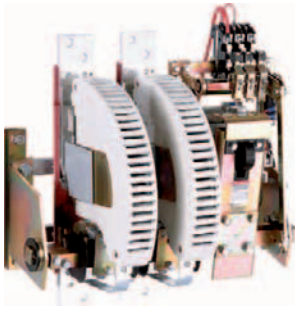

IORR1400..-MT	IORR1700..-MT	IORR2100..-MT	IORR2500..-MT	IORR3200..-MT	IORR3800..-MT	IORR4500..-MT	IORR5100..-MT
IORE1400..-MT	IORE1700..-MT	IORE2100..-MT	IORE2500..-MT	IORE3200..-MT	IORE3800..-MT	IORE4500..-MT	IORE5100..-MT

1250 A	1650 A	1850 A	2200 A	3000 A	3500 A	4000 A	4500 A
970 A	1170 A	1270 A	-	-	-	-	-
610 A	680 A	810 A	-	-	-	-	-
1000 kW	1200 kW	1300 kW	-	-	-	-	-

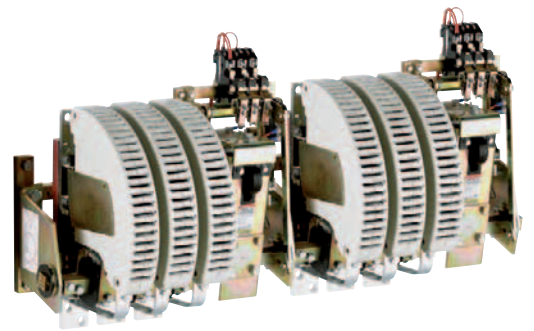

IORR1000	IORR1400	IORR1700	IORR2100	IORR2500	IORR3200	IORR3800	IORR4500	IORR5100
IORE1000	IORE1400	IORE1700	IORE2100	IORE2500	IORE3200	IORE3800	IORE4500	IORE5100

1000 A	1350 A	1650 A	2000 A	2400 A	3200 A	3800 A	4500 A	5000 A
800 A	1060 A	1260 A	1520 A	-	-	-	-	-
800 A	1080 A	1220 A	1340 A	-	-	-	-	-
450 kW	630 kW	750 kW	900 kW	-	-	-	-	-

R contactors for the DC circuits switching

Voltage U_e up to **1500 V DC**

Current I_e up to **5000 A**

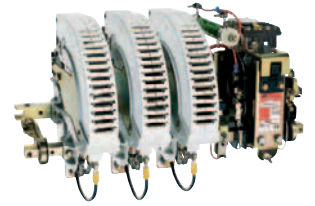

Contactor type	AC control circuit	~	IORR63..-CC	IORR125..-CC	IORR200..-CC	IORR400..-CC	IORR500..-CC
	DC control circuit	≡	IORE63..-CC	IORE125..-CC	IORE200..-CC	IORE400..-CC	IORE500..-CC
Number of poles in series*	Categories	U_e max.					
1 pole	DC-1	500 V DC	I_e 85 A	170 A	275 A	400 A	550 A
	DC-3 / DC-5	500 V DC	I_e 68 A	140 A	205 A	350 A	500 A
2 poles	DC-1	1000 V DC	I_e 85 A	170 A	275 A	400 A	550 A
	DC-3 / DC-5	1000 V DC	I_e 68 A	140 A	205 A	350 A	500 A
3 poles	DC-1	1500 V DC	I_e 85 A**	170 A**	275 A**	400 A**	550 A**
	DC-3 / DC-5	1500 V DC	I_e 68 A**	140 A**	205 A**	350 A**	500 A**

*Number of poles to be fitted in series according to the operational voltage and the utilization categories.

**Version with increased insulation for $1000 \text{ V DC} < U_e \leq 1500 \text{ V DC}$, please consult us.

Contactors

UL / CSA approved 

Voltage U_e up to **600 V DC**

Current I_e up to **2000 A**

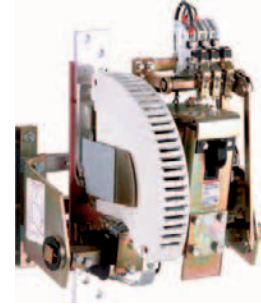

Contactor type	AC control circuit	~	IORR800-10-CC	IORR1000-10-CC	IORR1400-10-CC	IORR1700-10-CC	IORR2100-10-CC
	DC control circuit	≡	IORE800-10-CC	IORE1000-10-CC	IORE1400-10-CC	IORE1700-10-CC	IORE2100-10-CC
		U max.					
1 pole	General use	600 V DC	I_e 800 A	1000 A	1300 A	1700 A	2000 A

Recap:

All contactors fulfill the IEC 60947-4-1 / EN 60947-4-1 standards.

Utilization category DC-1: max. breaking current = $1.5 \times I_e$,
max. making current = $1.5 \times I_e$.

Utilization categories DC-3 / DC-5: max. breaking current = $4 \times I_e$,
max. making current = $4 \times I_e$.

Contactors with NC poles, magnetic or mechanical latching devices on request.

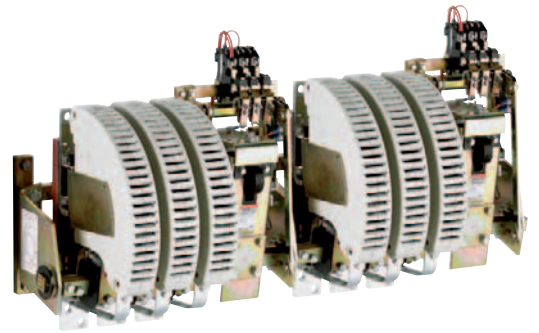

[IORR800..-CC](#) [IORR1000..-CC](#) [IORR1400..-CC](#) [IORR1700..-CC](#) [IORR2100..-CC](#) [IORR2500..-CC](#) [IORR3200..-CC](#) [IORR3800..-CC](#) [IORR4500..-CC](#) [IORR5100..-CC](#)
[IORE800..-CC](#) [IORE1000..-CC](#) [IORE1400..-CC](#) [IORE1700..-CC](#) [IORE2100..-CC](#) [IORE2500..-CC](#) [IORE3200..-CC](#) [IORE3800..-CC](#) [IORE4500..-CC](#) [IORE5100..-CC](#)

Ue max.

750 V DC	800 A	1000 A	1250 A	1600 A	2000 A	2300 A	3200 A	3800 A	4500 A	5000 A
600 V DC	720 A	1000 A	1250 A	1600 A	2000 A	On request	On request	On request	On request	On request
1500 V DC	800 A	1000 A	1250 A	1600 A	2000 A	2300 A	3200 A	3800 A	4500 A	5000 A
1000 V DC	720 A	1000 A	1250 A	1600 A	2000 A	On request	On request	On request	On request	On request
1500 V DC	800 A	1000 A	1250 A	1600 A	2000 A	2300 A	3200 A	3800 A	4500 A	5000 A
1500 V DC	720 A	1000 A	1250 A	1600 A	2000 A	On request	On request	On request	On request	On request

Product overview

Upper terminal plate
for power circuit (network)

2 N.O. main poles with arc chutes

Main frame
for contactor fixing

Lower terminal plate
for power circuit (utilization)

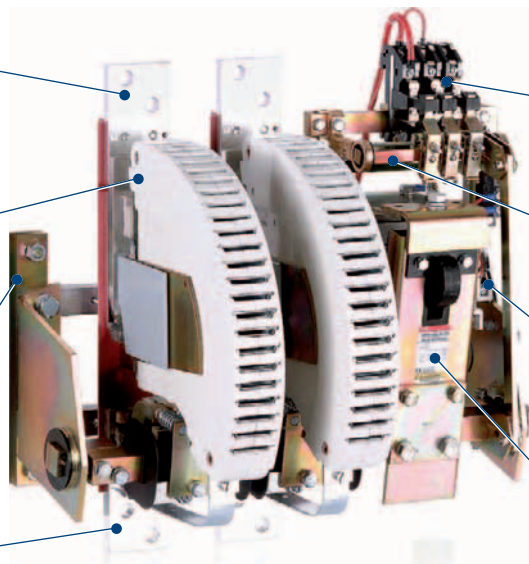

CA15.. auxiliary contacts
1 N.O. + 1 N.C. fitted as
standard (extra auxiliary
contacts on request)

Auxiliary frame
for auxiliary contacts

Connecting terminals
for coil supply

Electro-magnet (RR type),
laminated magnetic circuit,
AC coil, direct supply

Questionnaire

Specification for R contactors

Customer
 Contact person Date
 Tel. e-mail

ABB
 Contact person
 Tel.

Quantity Requested delivery date
 Project / Application

Power circuit

AC switching

Application type
 AC-1 (resistive load)
 AC-3 (direct starting, switching off running motors)
 No load breaking
 Other

Number of poles: N.O. N.C.
 Rated operational current I_e A
 Max. making current A
 Max. breaking current A
 Rated operational voltage U_e V Hz

or

DC switching

Application type
 DC-1 (resistive load)
 DC-3 (shunt motors)
 DC-5 (series motors)
 No load breaking
 Other L/R ms

Number of poles: N.O. N.C.
 Rated operational current I_e A
 Making current A
 Breaking current min. A max. A
 Rated operational voltage U_e V DC

Operating conditions

Switching frequency cycles/h
 Mech. durability required (millions of operating cycles)
 Remarks

Auxiliary contacts

Number of N.O. auxiliary contacts
 Number of N.C. auxiliary contacts

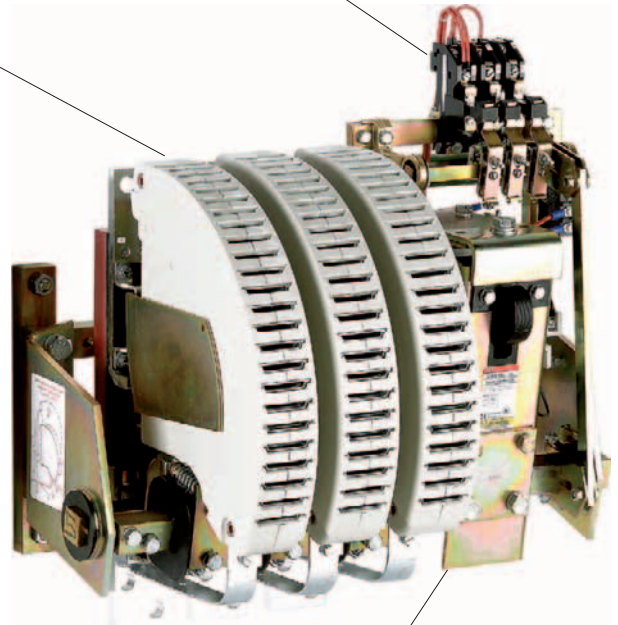

Control circuit (coil)

AC Voltage V Hz
 DC Voltage V DC

Options
 Magnetical latching
 Mechanical latching

Accessories

Please add any other useful documents for further information e.g. technical specification, drawing, wiring diagram, etc.

Replacement of an existing contactor

Brand
 Type
 Fixing dimension F = mm
 Overall dimensions W = mm
 H = mm
 D = mm

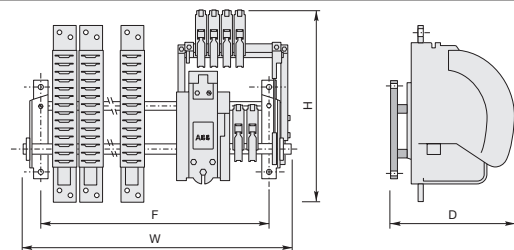

Please photocopy and forward. Questionnaire also available on the ABB Website:

www.abb.com/lowvoltage Section: Our offering Select: Control Products > Contactors > Bar mounted contactors



Motor control and protection

Motor control and protection

Benefits and advantages	8/2
Technical data	8/3

Motor control and protection

Benefits and advantages

UMC100-FBP is a flexible, modular and expandable motor management system for constant-speed low-voltage range motors. Its most important tasks include motor protection, prevention of plant standstills and the reduction of down time. This is made possible by early information relating to possible motor problems which avoids unplanned plant standstills. Even if a motor trips, quick diagnosis of the cause of the fault serves to reduce downtime.

UMC100-FBP combines in a very compact unit:

Motor protection

- Overload, underload
- Overvoltage, undervoltage
- Blocked rotor, low / high current
- Phase failure, imbalance, phase sequence
- Earth leakage
- Thermistor protection
- Limitation of starts per time
- One single version with integrated measuring system covers the rated motor current from 0,24 to 63 A

Motor control

- Integrated and easy to parametrize motor starter functions like direct, reverse, star-delta,...
- Additionally free programmable logic for application specific control functions
- Expansion modules DX111, DX122 for more I/Os
- Expansion modules VI150, VI155 for 3-phase voltage measuring

Motor diagnostics

- Quick and comprehensive access to all relevant data via fieldbus and/or operator panel
- Current, thermal load
- Phase voltages
- Power factor
- Energy

Communication

- Communication-independent basic device
- Freely selectable fieldbus protocol with FieldBusPlug
- Profibus DP
- DeviceNet
- Modbus
- CANopen

Typical application segments

- Oil & gas
- Cement
- Paper
- Mining
- Steel
- Chemical industry

Further information

UMC & FBP Catalogue 2CDC 190 022 D0204

UMC & FBP Brochure 2CDC 135 011 B0202

Motor control and protection

Technical data



Basic device UMC100-FBP

UMC100-FBP allows the connection of one I/O-expansion module DX111 or DX122, and one voltage module VI150 or VI155. Expansion modules are connected via 2-wire bus, the max. distance to UMC100-FBP is 3 m.

Main power	
Voltage	max 1000 V AC
Frequency	45 to 65 Hz
Rated motor current	0.24 to 63 A, without accessories Greater currents with transformer
Transformer diameter	11 mm (max 25 mm ²)
Tripping classes	5, 10, 20, 30, 40 in accordance with EN/IEC 60947-4-1
Short-circuit protection	Separate fuse on network side

Control unit	
Supply voltage	24 V DC
Reverse polarity protection	yes
Inputs	6 digital inputs 24 V DC 1 PTC input
Outputs	3 relay outputs relay 1 digital output transistor
Interfaces	1 for ABB FieldBusPlug 1 for UMC100-PAN control station 1 for expansion module
Parametric assignment	via fieldbus, control station and / or software
Addressing	Control station or addressing set
LEDs	3 LEDs: green, yellow, red

Environment and mechanical data	
Fastening	on DIN busbar (EN50022-35) or with 4 screws x M4
Dimensions (W x H x D)	70 x 105 x 110 mm (incl. FieldBusPlug and control panel)
Weight	0.39 kg
Terminal cross-section	max. 2.5 mm ² or 2 x 1.5 mm ²



I/O-expansion modules DX111 / DX122

Expansion modules to increase the number of I/Os of a UMC100-FBP. Easy use of inputs by parametrizing for fault or warning; individual message on operator panel configurable.

Supply voltage		24 V DC
Inputs	DX111	8 digital inputs 24 V DC
	DX122	8 digital inputs 110/230 V AC
Outputs	4 relay outputs relay	
	1 analogue output, 0/4 to 20 mA / 0 to 10 V configurable	
Fastening		on DIN busbar (EN50022-35)
Dimensions (W x H x D)		45 x 77 x 100 mm (without terminal block)

Motor control and protection

Technical data

NEW



Voltage expansion modules

Measures the 3 phase voltages of a motor. Different versions for use in grounded and ungrounded networks.

Supply voltage		24 V DC
Inputs	VI150	3 analogue inputs 150 - 690 V AC
		For use in grounded networks
	VI155	3 analogue inputs 150 - 690 V AC
		For use in all networks
Outputs		1 relay output
Fastening		on DIN busbar (EN50022-35)
Dimensions (W x H x D)		22.5 x 77 x 100 mm (without terminal block)



Control panel UMC100-PAN

Installation on the device or on the switching cabinet door

Graphics-enabled and backlit display, 3 LEDs for status indication

Freely configurable error messages

Multilingual: German, English, French, Italian, Portuguese, Spanish, Russian

Notes

A series of horizontal dotted lines for taking notes.

Coordination with short-circuit protection devices

In compliance with standards IEC 60947-4-1 and EN 60947-4-1, we define for the contactors and starters the type, rating and characteristics of the short-circuit protection devices SCPD which allow selective protection against overloads and ensure protection against short circuits.

Basic functions

Any starter is designed to:

- start motors,
- ensure continuous functioning of motors,
- disconnect motors from the supply line,
- guarantee protection of motors against overloads.

The starter is typically made up of a switching device (contactor) and an overload protection device (thermal overload relay TOR or electronic overload relay EOR).

These two devices MUST be coordinated with equipment capable of providing protection against short circuit (SCPD: short circuit protective device): typically a circuit breaker with magnetic release only or a switch fuse. These are not necessarily part of the starter.

Applicable standards

IEC 60947-4-1 (EN 60947-4-1) precisely defines the different points to be considered in order to carry out correct coordination.

Complete coordination for a combination includes the following points:

- Selectivity test between the overload relay and the short-circuit protection device SCPD.
- Short-circuit condition tests:
 - at prospective "r" currents - These currents depend on the rated operational current of the starter (**I_e** AC-3) and are given by the standard (Table 11). For example:
 - r = 1kA for **I_e** AC-3 < 16 A
 - r = 3 kA for 16 A < **I_e** AC-3 < 63 A
 - r = 5 kA for 63 A < **I_e** AC-3 < 125 A etc.
 - at the rated prospective short-circuit current "**I_q**" - This is the maximum current that the combination can withstand, for example 50 kA.

9 Types of coordination

IEC 60947-4-1 (EN 60947-4-1) defines two types of coordination according to the expected level of service continuity. Acceptable extreme damage for the switchgear is divided into two types.

Type 1: In short-circuit conditions, the contactor or starter does not endanger persons or installations and will not be able to then operate without being repaired or having parts replaced.

Type 2: In short-circuit conditions, the contactor or starter does not endanger persons or installations and will be able to operate afterwards. The risk of contacts light welding is acceptable.

The complete ABB offer

ABB has acquired years of experience with respect to problems of coordination and is able to make a complete offer based on tests performed in its qualified laboratories. This offer includes 400 V, 500 V, 690 V networks.

A complete data base of coordination tables, according to IEC 60947-4-1 (EN 60947-4-1), is available on the ABB Website.

In the coordination tables the following short-circuit protection devices are recommended:

- Moulded case circuit-breakers (MCCBs)
- Miniature circuit-breakers (MCBs)
- Switch-disconnector-fuses (aM, gG and BS)
- Manual Motor Starters (M.M.S.).

General remarks applicable to all tables

- Each table is defined for a maximum ambient temperature of 40 °C. For higher temperatures, apply a derating factor according to the following rules:
 - Fuses: factor of 0.8 applied to **I_n** for an ambient temperature of 70 °C
 - MCCBs and MCBs: factor of 0.8 applied to **I_n** for an ambient temperature of 60 °C
 - The starter derating factor depends on the operating conditions of thermal overload relays:
 - Factor of 0.9 applied to **I_n** for an ambient temperature of 70 °C.
- Each table is defined for motor currents: 3-phase motors, 4-pole
- **Normal starting** means a starting time < 2 s. - **Difficult starting** means an accelerating time 10 s < **t_s** < 30 s
- **Tripping classes** of thermal overload relays according to IEC 60947-4-1 (EN 60947-4-1): 10A and 10, and 30 for SU types
- In the tables with MCCBs, these are fitted with the magnetic relay alone. Setting is always carried out at > 12.3 **I_e** AC-3 so that the transient current peak occurring during starting does not lead to tripping.

Coordination with short-circuit protection devices

A motor starter is typically made up of a switching device (contactor) and an overload protection device (see opposite page "Basic functions").

These two devices **must** be coordinated with an equipment capable of providing protection against short circuit (SCPD: Short-Circuit Protection Device).

A complete data base of coordination tables, according to [IEC 60947-4-1](#) (EN 60947-4-1) or [UL 508 / UL 60947-4-1](#), is available on the ABB Website: see below.

Selection

Simple or multiple selections all from the same screen.

Short-circuit protection devices

- Air circuit breakers
- Fuses "gG" or "aM"
- Miniature circuit breaker
- Moulded case circuit breaker
- Manual motor starter

Starter type

- Direct-on-line normal start
- Direct-on-line heavy duty
- Star-delta normal start
- Soft starter normal start

Coordination

- IEC type 1 or type 2
- UL type A to Type F

Results

- Search results displayed at the bottom of the selection page.
- Only the most appropriate solutions to your application, will be displayed at the bottom of the page.
- "Enable Smart Current Search" function featured for the short-circuit current where "near to" selected values also are included in the result.
- Possible to print the page to a pdf file or from your printer.
- "Clear selection" function to deselect all selected.

Fuses, 400 V, 80 kA, DOL-NS, Coordination type IEC Type 2									
Motor		Fuses IEC			Contactor	Overload Relay			
Rated Power [kW]	Rated Current [A]	Switch-Fuse Type	Rating [A]	Type and Size	Type	Type	Current setting range [A]	Max allowed load current [A]	Table
0.37	1.1	OS32D	2	OFAM 00aM	A9	E16DU2.7 10 *	0.90 - 2.70	1.4	>>
0.37	1.1	OS32D	2	OFAM 00aM	A9	TA2EDU 1.4	1.00 - 1.40	1.4	>>
0.37	1.1	OS32D	2	OFAM 00aM	A9	UMC22/100 10 *	0.24 - 63.00	1.4	>>
0.37	1.1	OS32D	4	OFAA 00H	A9	UMC22/100 10 *	0.24 - 63.00	1.3	>>
0.37	1.1	OS32D	4	OFAA 00H	A9	E16DU2.7 10 *	0.90 - 2.70	1.3	>>
0.37	1.1	OS32D	4	OFAA 00H	A9	TA2EDU 1.4	1.00 - 1.40	1.4	>>

Fuses, 400 V, 80 kA, DOL-NS, Coordination type IEC Type 2, Overload Relay TOL									
Motor		Fuses IEC			Contactor	Overload Relay			
Rated Power [kW]	Rated Current [A]	Switch-Fuse Type	Rating [A]	Type and Size	Type	Type	Current setting range [A]	Max allowed load current [A]	Table
0.25	0.85	OS32GD	2	OFAF 000aM	AF09	TF42-1.0	0.74 - 1.00	1	>>
0.12	0.44	OS32GD	2	OFAF 000H	AF09	TF42-0.55	0.42 - 0.55	0.55	>>

Access

To find the coordination tables for motor protection, please see:

www.abb.com/lowvoltage then go to the right menu: "Support", select: "[Online Product Selection Tools](#)" then select "[Coordination Tables for motor protection](#)"

Index

Order code classification

Order code	Type	Page	Order code	Type	Page	Order code	Type	Page
1SAM101901R0001	HK-11	2/45	1SAM201906R1105	PS1-5-0-65	2/6	1SAM360000R1004	MO132-0.63	2/18
1SAM101901R0002	HK-20	2/45	1SAM201906R1112	PS1-2-1-65	2/6	1SAM360000R1005	MO132-1.0	2/18
1SAM101901R0003	HK-02	2/45	1SAM201906R1113	PS1-3-1-65	2/6	1SAM360000R1006	MO132-1.6	2/18
1SAM101903R0024	UAF-24	2/45	1SAM201906R1114	PS1-4-1-65	2/6	1SAM360000R1007	MO132-2.5	2/18
1SAM101903R0048	UAF-48	2/45	1SAM201906R1115	PS1-5-1-65	2/6	1SAM360000R1008	MO132-4.0	2/18
1SAM101903R0060	UAF-60	2/45	1SAM201906R1122	PS1-2-2-65	2/6	1SAM360000R1009	MO132-6.3	2/18
1SAM101903R0110	UAF-110	2/45	1SAM201906R1123	PS1-3-2-65	2/6	1SAM360000R1010	MO132-10	2/18
1SAM101903R0230	UAF-230	2/45	1SAM201906R1124	PS1-4-2-65	2/6	1SAM360000R1011	MO132-16	2/18
1SAM101903R0400	UAF-400	2/45	1SAM201906R1125	PS1-5-2-65	2/6	1SAM360000R1012	MO132-12	2/18
1SAM101903R0415	UAF-415	2/45	1SAM201907R1101	S1-M1-25	2/6	1SAM360000R1013	MO132-20	2/18
1SAM101903R0500	UAF-500	2/45	1SAM201907R1102	S1-M2-25	2/6	1SAM360000R1014	MO132-25	2/18
1SAM101904R0003	SK-11	2/45	1SAM201907R1103	S1-M3-25	2/6	1SAM360000R1015	MO132-32	2/18
1SAM101909R0001	AA-24	2/45	1SAM201908R1001	BS1-3	2/6	1SAM401901R1001	HK4-11	2/28
1SAM101909R0002	AA-230	2/45	1SAM201909R1001	FS116	2/6	1SAM401901R1002	HK4-W	2/28
1SAM101909R0003	AA-400	2/45	1SAM201910R1001	AA1-24	2/7	1SAM401902R1001	HK54-11	2/28
1SAM101923R0002	MSMN	2/9	1SAM201910R1002	AA1-110	2/7	1SAM401902R1002	HKS4-20	2/28
1SAM101923R0012	MSMNO	2/9	1SAM201910R1003	AA1-230	2/7	1SAM401902R1003	HKS4-02	2/28
1SAM101924R0003	MSOX-32	2/9	1SAM201910R1004	AA1-400	2/7	1SAM401904R1001	SK4-11	2/28
1SAM101924R0013	MSOX-30	2/9	1SAM201911R1010	IB132-G	2/8	1SAM401905R1001	UA4-110	2/28
1SAM101928R0001	HKF-11	2/45	1SAM201911R1011	IB132-Y	2/8	1SAM401905R1002	UA4-230	2/28
1SAM101928R0002	HKF-20	2/45	1SAM201912R1010	DMS132-G	2/8	1SAM401905R1003	UA4-400	2/28
1SAM101937R0012	PS3-2.0	2/44	1SAM201912R1011	DMS132-Y	2/8	1SAM401905R1004	UA4-24	2/28
1SAM101937R0013	PS3-3.0	2/44	1SAM201913R1103	S1-M3-35	2/6	1SAM401906R1001	UA4-HK-230	2/28
1SAM101937R0014	PS3-4.0	2/44	1SAM201916R1103	PS1-3-0-100	2/6	1SAM401906R1002	UA4-HK-400	2/28
1SAM101937R0015	PS3-5.0	2/44	1SAM201916R1104	PS1-4-0-100	2/6	1SAM401907R1001	AA4-24	2/28
1SAM101937R0016	PS3-6.0	2/44	1SAM201916R1105	PS1-5-0-100	2/6	1SAM401907R1002	AA4-110	2/28
1SAM101937R0022	PS3-2.1	2/44	1SAM201916R1113	PS1-3-1-100	2/6	1SAM401907R1003	AA4-230	2/28
1SAM101937R0023	PS3-3.1	2/44	1SAM201916R1114	PS1-4-1-100	2/6	1SAM401907R1004	AA4-400	2/28
1SAM101937R0024	PS3-4.1	2/44	1SAM201916R1115	PS1-5-1-100	2/6	1SAM401908R1001	KA450	2/27
1SAM101937R0025	PS3-5.1	2/44	1SAM201916R1123	PS1-3-2-100	2/6	1SAM401910R1001	TB450	2/27
1SAM101937R0032	PS3-2.2	2/44	1SAM201920R1001	MSHD-LB	2/9	1SAM401911R1001	PS4-2.0	2/27
1SAM101937R0034	PS3-4.2	2/44	1SAM201920R1002	MSHD-LY	2/9	1SAM401911R1002	PS4-3.0	2/27
1SAM101938R0001	S3-M1	2/44	1SAM201920R1011	MSHD-LTB	2/17	1SAM401911R1003	PS4-4.0	2/27
1SAM101938R0002	S3-M2	2/44	1SAM201920R1012	MSHD-LTY	2/17	1SAM401911R1004	PS4-2.2	2/27
1SAM101938R0003	B53-3	2/44	1SAM250000R1001	MS116-0.16	2/2	1SAM401911R1005	PS4-3.2	2/27
1SAM101938R0004	S3-M3	2/44	1SAM250000R1002	MS116-0.25	2/2	1SAM401911R1006	PS4-4.2	2/27
1SAM101940R1000	IB325-G	2/47	1SAM250000R1003	MS116-0.4	2/2	1SAM401911R1007	S4-M1	2/27
1SAM101940R1001	IB325-Y	2/47	1SAM250000R1004	MS116-0.63	2/2	1SAM401911R1008	BS4-3	2/27
1SAM101941R1000	DMS325-G	2/47	1SAM250000R1005	MS116-1.0	2/2	1SAM401912R1001	DX495	2/27
1SAM101941R1001	DMS325-Y	2/47	1SAM250000R1006	MS116-1.6	2/2	1SAM450000R1005	MS450-40	2/24
1SAM101943R0001	CK-11	2/45	1SAM250000R1007	MS116-2.5	2/2	1SAM450000R1006	MS450-45	2/24
1SAM150000R1001	MS325-0.16	2/40	1SAM250000R1008	MS116-4.0	2/2	1SAM450000R1007	MS450-50	2/24
1SAM150000R1002	MS325-0.25	2/40	1SAM250000R1009	MS116-6.3	2/2	1SAM460000R1005	MO450-40	2/32
1SAM150000R1003	MS325-0.4	2/40	1SAM250000R1010	MS116-10	2/2	1SAM460000R1006	MO450-45	2/32
1SAM150000R1004	MS325-0.63	2/40	1SAM250000R1011	MS116-16	2/2	1SAM460000R1007	MO450-50	2/32
1SAM150000R1005	MS325-1	2/40	1SAM250000R1012	MS116-12	2/2	1SAM501901R1001	KA495	2/27
1SAM150000R1006	MS325-1.6	2/40	1SAM250000R1013	MS116-20	2/2	1SAM501902R1001	KA495C	2/27
1SAM150000R1007	MS325-2.5	2/40	1SAM250000R1014	MS116-25	2/2	1SAM550000R1007	MS495-63	2/24
1SAM150000R1008	MS325-4	2/40	1SAM250000R1015	MS116-32	2/2	1SAM550000R1008	MS495-75	2/24
1SAM150000R1009	MS325-6.3	2/40	1SAM250005R1001	MS116-0.16-HKF1-11	2/2	1SAM550000R1009	MS495-90	2/24
1SAM150000R1010	MS325-9	2/40	1SAM250005R1002	MS116-0.25-HKF1-11	2/2	1SAM550000R1010	MS495-100	2/24
1SAM150000R1011	MS325-12.5	2/40	1SAM250005R1003	MS116-0.4-HKF1-11	2/2	1SAM560000R1007	MO495-63	2/32
1SAM150000R1012	MS325-16	2/40	1SAM250005R1004	MS116-0.63-HKF1-11	2/2	1SAM560000R1008	MO495-75	2/32
1SAM150000R1013	MS325-20	2/40	1SAM250005R1005	MS116-1.0-HKF1-11	2/2	1SAM560000R1009	MO495-90	2/32
1SAM150000R1014	MS325-25	2/40	1SAM250005R1006	MS116-1.6-HKF1-11	2/2	1SAM560000R1010	MO495-100	2/32
1SAM150005R0001	MS325-0.16-HKF11	2/40	1SAM250005R1007	MS116-2.5-HKF1-11	2/2	1SAM580000R1004	MS497-32	2/24
1SAM150005R0002	MS325-0.25-HKF11	2/40	1SAM250005R1008	MS116-4.0-HKF1-11	2/2	1SAM580000R1005	MS497-40	2/24
1SAM150005R0003	MS325-0.4-HKF11	2/40	1SAM250005R1009	MS116-6.3-HKF1-11	2/2	1SAM580000R1006	MS497-50	2/24
1SAM150005R0004	MS325-0.63-HKF11	2/40	1SAM250005R1010	MS116-10.0-HKF1-11	2/2	1SAM580000R1007	MS497-63	2/24
1SAM150005R0005	MS325-1-HKF11	2/40	1SAM250005R1011	MS116-16.0-HKF1-11	2/2	1SAM580000R1008	MS497-75	2/24
1SAM150005R0006	MS325-1.6-HKF11	2/40	1SAM250005R1012	MS116-12.0-HKF1-11	2/2	1SAM580000R1009	MS497-90	2/24
1SAM150005R0007	MS325-2.5-HKF11	2/40	1SAM250005R1013	MS116-20-HKF1-11	2/2	1SAM580000R1010	MS497-100	2/24
1SAM150005R0008	MS325-4-HKF11	2/40	1SAM250005R1014	MS116-25-HKF1-11	2/2	1SAM590000R1001	MO496-16	2/32
1SAM150005R0009	MS325-6.3-HKF11	2/40	1SAM250005R1015	MS116-32-HKF1-11	2/2	1SAM590000R1002	MO496-20	2/32
1SAM150005R0010	MS325-9-HKF11	2/40	1SAM301901R1001	CK1-11	2/15	1SAM590000R1003	MO496-25	2/32
1SAM150005R0011	MS325-12.5-HKF11	2/40	1SAM301901R1002	CK1-20	2/15	1SAM590000R1004	MO496-32	2/32
1SAM150005R0012	MS325-16-HKF11	2/40	1SAM301901R1003	CK1-02	2/15	1SAM590000R1005	MO496-40	2/32
1SAM150005R0013	MS325-20-HKF11	2/40	1SAM350000R1001	MS132-0.16	2/10	1SAM590000R1006	MO496-50	2/32
1SAM150005R0014	MS325-25-HKF11	2/40	1SAM350000R1002	MS132-0.25	2/10	1SAM590000R1007	MO496-63	2/32
1SAM160000R1003	MO325-0.4	2/49	1SAM350000R1003	MS132-0.4	2/10	1SAM590000R1008	MO496-75	2/32
1SAM160000R1004	MO325-0.63	2/49	1SAM350000R1004	MS132-0.63	2/10	1SAM590000R1009	MO496-90	2/32
1SAM160000R1005	MO325-1	2/49	1SAM350000R1005	MS132-1.0	2/10	1SAM590000R1010	MO496-100	2/32
1SAM160000R1006	MO325-1.6	2/49	1SAM350000R1006	MS132-1.6	2/10	1SAX10110R0001	DB16E	6/43
1SAM160000R1007	MO325-2.5	2/49	1SAM350000R1007	MS132-2.5	2/10	1SAX111001R1101	E16DU-0.32	6/39
1SAM160000R1008	MO325-4	2/49	1SAM350000R1008	MS132-4.0	2/10	1SAX111001R1102	E16DU-1.0	6/39
1SAM160000R1009	MO325-6.3	2/49	1SAM350000R1009	MS132-6.3	2/10	1SAX111001R1103	E16DU-2.7	6/39
1SAM160000R1010	MO325-9	2/49	1SAM350000R1010	MS132-10	2/10	1SAX111001R1104	E16DU-6.3	6/39
1SAM160000R1011	MO325-12.5	2/49	1SAM350000R1011	MS132-16	2/10	1SAX111001R1105	E16DU-18.9	6/39
1SAM160000R1012	MO325-16	2/49	1SAM350000R1012	MS132-12	2/10	1SAX121001R1101	EF19-0.32	6/44
1SAM160000R1013	MO325-20	2/49	1SAM350000R1013	MS132-20	2/10	1SAX121001R1102	EF19-1.0	6/44
1SAM160000R1014	MO325-25	2/49	1SAM350000R1014	MS132-25	2/10	1SAX121001R1103	EF19-2.7	6/44
1SAM201901R1001	HKF1-11	2/7	1SAM350000R1015	MS132-32	2/10	1SAX121001R1104	EF19-6.3	6/44
1SAM201902R1001	HK1-11	2/7	1SAM350005R1001	MS132-0.16-HKF1-11	2/10	1SAX121001R1105	EF19-18.9	6/44
1SAM201902R1002	HK1-20	2/7	1SAM350005R1002	MS132-0.25-HKF1-11	2/10	1SAX201110R1001	DB45E	6/43
1SAM201902R1003	HK1-02	2/7	1SAM350005R1003	MS132-0.4-HKF1-11	2/10	1SAX211001R1101	E45DU-30	6/39
1SAM201902R1004	HK1-20L	2/7	1SAM350005R1004	MS132-0.63-HKF1-11	2/10	1SAX211001R1102	E45DU-45	6/39
1SAM201903R1001	SK1-11	2/7	1SAM350005R1005	MS132-1.0-HKF1-11	2/10	1SAX221001R1101	EF45-30	6/44
1SAM201903R1002	SK1-20	2/7	1SAM350005R1006	MS132-1.6-HKF1-11	2/10	1SAX221001R1102	EF45-45	6/44
1SAM201903R1003	SK1-02	2/7	1SAM350005R1007	MS132-2.5-HKF1-11	2/10	1SAX301110R1001	DB80E	6/43
1SAM201904R1001	UA1-24	2/7	1SAM350005R1008	MS132-4.0-HKF1-11	2/10	1SAX301110R1002	DB140E	6/43
1SAM201904R1002	UA1-48	2/7	1SAM350005R1009	MS132-6.3-HKF1-11	2/10	1SAX311001R1101	E80DU-80	6/39
1SAM201904R1003	UA1-60	2/7	1SAM350005R1010	MS132-10.0-HKF1-11	2/10	1SAX321001R1101	E140DU-140	6/39
1SAM201904R1004	UA1-120	2/7	1SAM350005R1011	MS132-16.0-HKF1-11	2/10	1SAX501904R0001	LT200E	6/48
1SAM201904R1005	UA1-208	2/7	1SAM350005R1012	MS132-12.0-HKF1-11	2/10	1SAX511001R1101	E200DU-200	6/48
1SAM201904R1006	UA1-230	2/7	1SAM350005R1013	MS132-20-HKF1-11	2/10	1SAX521001R1101	E320DU-320	6/48
1SAM201904R1007	UA1-400	2/7	1SAM350005R1014	MS132-25-HKF1-11	2/10	1SAX601904R0001	LT320E	6/48
1SAM201904R1008	UA1-415	2/7	1SAM350005R1015	MS132-32-HKF1-11	2/10	1SAX701904R0001	LT500E	6/51
1SAM201906R1102	PS1-2-0-65	2/6	1SAM360000R1001	MO132-0.16	2/18	1SAX711001R1101	E500DU-500	6/51
1SAM201906R1103	PS1-3-0-65	2/6	1SAM360000R1002	MO132-0.25	2/18	1SAX801904R0001	LT800E	6/51
1SAM201906R1104	PS1-4-0-65	2/6	1SAM360000R1003	MO132-0.4	2/18	1SAX811001R1101	E800DU-800	6/51

Index

Order code classification

Order code	Type	Page	Order code	Type	Page	Order code	Type	Page
1SAZ201108R0001	DB25/25A	6/14	1SAZ721201R1053	TF42-35	6/6	1SBK103800M2600	VAS09SEM-26M	4/16
1SAZ201108R0002	DB25/32A	6/14	1SAZ721201R1055	TF42-38	6/6	1SBK103800M2800	VAS09SEM-28M	4/16
1SAZ201307R0002	DX25	6/14	1SBH101001R1622	NS22E-16	4/24	1SBK103900M8100	VASL09SEM-81M	4/17
1SAZ201501R0001	DS25-A-24	6/14	1SBH101001R1631	NS31E-16	4/24	1SBK103900M8300	VASL09SEM-83M	4/17
1SAZ201501R0003	DS25-A-110	6/14	1SBH101001R1640	NS40E-16	4/24	1SBK103900M8600	VASL09SEM-86M	4/17
1SAZ201501R0005	DS25-A-220/380	6/14	1SBH101001R1644	NS44E-16	4/24	1SBK103900M8800	VASL09SEM-88M	4/17
1SAZ201501R0006	DS25-A-500	6/14	1SBH101001R1653	NS53E-16	4/24	1SBK113600M1600	VAS12EM-16M	4/16
1SAZ201504R0001	DR25-A-24	6/14	1SBH101001R1662	NS62E-16	4/24	1SBK113600M2000	VAS12EM-20M	4/16
1SAZ201504R0002	DR25-A-48	6/14	1SBH101001R1671	NS71E-16	4/24	1SBK113600M2600	VAS12EM-26M	4/16
1SAZ201504R0003	DR25-A-110	6/14	1SBH101001R1680	NS80E-16	4/24	1SBK113600M2800	VAS12EM-28M	4/16
1SAZ201504R0005	DR25-A-220/380	6/14	1SBH101001R2022	NS22E-20	4/24	1SBK113700M8100	VASL12EM-81M	4/17
1SAZ201504R0006	DR25-A-500	6/14	1SBH101001R2031	NS31E-20	4/24	1SBK113700M8300	VASL12EM-83M	4/17
1SAZ211201R1005	TA25DU-0.16	6/10	1SBH101001R2040	NS40E-20	4/24	1SBK113700M8600	VASL12EM-86M	4/17
1SAZ211201R1009	TA25DU-0.25	6/10	1SBH101001R2044	NS44E-20	4/24	1SBK113700M8800	VASL12EM-88M	4/17
1SAZ211201R1013	TA25DU-0.4	6/10	1SBH101001R2053	NS53E-20	4/24	1SBK113800M1600	VAS12SEM-16M	4/16
1SAZ211201R1017	TA25DU-0.63	6/10	1SBH101001R2062	NS62E-20	4/24	1SBK113800M2000	VAS12SEM-20M	4/16
1SAZ211201R1021	TA25DU-1.0	6/10	1SBH101001R2071	NS71E-20	4/24	1SBK113800M2600	VAS12SEM-26M	4/16
1SAZ211201R1023	TA25DU-1.4	6/10	1SBH101001R2080	NS80E-20	4/24	1SBK113800M2800	VAS12SEM-28M	4/16
1SAZ211201R1025	TA25DU-1.8	6/10	1SBH101001R2622	NS22E-26	4/24	1SBK113900M8100	VASL12SEM-81M	4/17
1SAZ211201R1028	TA25DU-2.4	6/10	1SBH101001R2631	NS31E-26	4/24	1SBK113900M8300	VASL12SEM-83M	4/17
1SAZ211201R1031	TA25DU-3.1	6/10	1SBH101001R2640	NS40E-26	4/24	1SBK113900M8600	VASL12SEM-86M	4/17
1SAZ211201R1033	TA25DU-4.0	6/10	1SBH101001R2644	NS44E-26	4/24	1SBK113900M8800	VASL12SEM-88M	4/17
1SAZ211201R1035	TA25DU-5.0	6/10	1SBH101001R2653	NS53E-26	4/24	1SBK123600M1600	VAS16EM-16M	4/16
1SAZ211201R1038	TA25DU-6.5	6/10	1SBH101001R2662	NS62E-26	4/24	1SBK123600M2000	VAS16EM-20M	4/16
1SAZ211201R1040	TA25DU-8.5	6/10	1SBH101001R2671	NS71E-26	4/24	1SBK123600M2600	VAS16EM-26M	4/16
1SAZ211201R1043	TA25DU-11	6/10	1SBH101001R2680	NS80E-26	4/24	1SBK123600M2800	VAS16EM-28M	4/16
1SAZ211201R1045	TA25DU-14	6/10	1SBH101001R2822	NS22E-28	4/24	1SBK123700M8100	VASL16EM-81M	4/17
1SAZ211201R1047	TA25DU-19	6/10	1SBH101001R2831	NS31E-28	4/24	1SBK123700M8300	VASL16EM-83M	4/17
1SAZ211201R1051	TA25DU-25	6/10	1SBH101001R2840	NS40E-28	4/24	1SBK123700M8600	VASL16EM-86M	4/17
1SAZ211201R1053	TA25DU-32	6/10	1SBH101001R2844	NS44E-28	4/24	1SBK123700M8800	VASL16EM-88M	4/17
1SAZ301110R0001	DB80	6/15	1SBH101001R2853	NS53E-28	4/24	1SBK123800M1600	VAS16SEM-16M	4/16
1SAZ311201R1001	TA42DU-25	6/15	1SBH101001R2862	NS62E-28	4/24	1SBK123800M2000	VAS16SEM-20M	4/16
1SAZ311201R1002	TA42DU-32	6/15	1SBH101001R2871	NS71E-28	4/24	1SBK123800M2600	VAS16SEM-26M	4/16
1SAZ311201R1003	TA42DU-42	6/15	1SBH101001R2880	NS80E-28	4/24	1SBK123800M2800	VAS16SEM-28M	4/16
1SAZ321201R1001	TA75DU-25	6/19	1SBH103001R8122	NSL22E-81	4/25	1SBK123900M8100	VASL16SEM-81M	4/17
1SAZ321201R1002	TA75DU-32	6/19	1SBH103001R8131	NSL31E-81	4/25	1SBK123900M8300	VASL16SEM-83M	4/17
1SAZ321201R1003	TA75DU-42	6/19	1SBH103001R8140	NSL40E-81	4/25	1SBK123900M8600	VASL16SEM-86M	4/17
1SAZ321201R1004	TA75DU-52	6/19	1SBH103001R8144	NSL44E-81	4/25	1SBK123900M8800	VASL16SEM-88M	4/17
1SAZ321201R1005	TA75DU-63	6/19	1SBH103001R8153	NSL53E-81	4/25	1SBL101001R1601	AS09-30-01-16	4/4
1SAZ321201R1006	TA75DU-80	6/19	1SBH103001R8162	NSL62E-81	4/25	1SBL101001R1610	AS09-30-01-16	4/4
1SAZ331201R1003	TA80DU-42	6/23	1SBH103001R8171	NSL71E-81	4/25	1SBL101001R1632	AS09-30-01-16	4/4
1SAZ331201R1004	TA80DU-52	6/23	1SBH103001R8180	NSL80E-81	4/25	1SBL101001R2010	AS09-30-01-20	4/4
1SAZ331201R1005	TA80DU-63	6/23	1SBH103001R8322	NSL22E-83	4/25	1SBL101001R2010	AS09-30-10-20	4/4
1SAZ331201R1006	TA80DU-80	6/23	1SBH103001R8331	NSL31E-83	4/25	1SBL101001R2032	AS09-30-01-20	4/4
1SAZ401110R0001	DB200	6/27	1SBH103001R8340	NSL40E-83	4/25	1SBL101001R2601	AS09-30-01-26	4/4
1SAZ401901R1001	LT200/A	6/31	1SBH103001R8344	NSL44E-83	4/25	1SBL101001R2610	AS09-30-10-26	4/4
1SAZ411201R1001	TA110DU-90	6/27	1SBH103001R8353	NSL53E-83	4/25	1SBL101001R2632	AS09-30-01-26	4/4
1SAZ411201R1002	TA110DU-110	6/27	1SBH103001R8362	NSL62E-83	4/25	1SBL101001R2801	AS09-30-01-28	4/4
1SAZ421201R1001	TA200DU-90	6/31	1SBH103001R8371	NSL71E-83	4/25	1SBL101001R2810	AS09-30-10-28	4/4
1SAZ421201R1002	TA200DU-110	6/31	1SBH103001R8380	NSL80E-83	4/25	1SBL101001R2832	AS09-30-32-28	4/6
1SAZ421201R1003	TA200DU-135	6/31	1SBH103001R8622	NSL22E-86	4/25	1SBL103001R8101	ASL09-30-01-81	4/5
1SAZ421201R1004	TA200DU-150	6/31	1SBH103001R8631	NSL31E-86	4/25	1SBL103001R8110	ASL09-30-01-81	4/5
1SAZ421201R1005	TA200DU-175	6/31	1SBH103001R8640	NSL40E-86	4/25	1SBL103001R8132	ASL09-30-32-81	4/7
1SAZ421201R1006	TA200DU-200	6/31	1SBH103001R8644	NSL44E-86	4/25	1SBL103001R8301	ASL09-30-01-83	4/5
1SAZ501901R1001	DT450/A185	6/35	1SBH103001R8653	NSL53E-86	4/25	1SBL103001R8310	ASL09-30-10-83	4/5
1SAZ501902R1001	DT450/A300	6/35	1SBH103001R8662	NSL62E-86	4/25	1SBL103001R8332	ASL09-30-32-83	4/7
1SAZ511201R1001	TA450DU-185	6/35	1SBH103001R8671	NSL71E-86	4/25	1SBL103001R8601	ASL09-30-01-86	4/5
1SAZ511201R1002	TA450DU-235	6/35	1SBH103001R8680	NSL80E-86	4/25	1SBL103001R8610	ASL09-30-10-86	4/5
1SAZ511201R1003	TA450DU-310	6/35	1SBH103001R8822	NSL22E-88	4/25	1SBL103001R8632	ASL09-30-32-86	4/7
1SAZ701901R0001	DB16	6/2	1SBH103001R8831	NSL31E-88	4/25	1SBL103001R8801	ASL09-30-01-88	4/5
1SAZ701902R0001	DB42	6/6	1SBH103001R8840	NSL40E-88	4/25	1SBL103001R8810	ASL09-30-10-88	4/5
1SAZ711201R1005	T16-0.13	6/2	1SBH103001R8844	NSL44E-88	4/25	1SBL103001R8832	ASL09-30-32-88	4/7
1SAZ711201R1008	T16-0.17	6/2	1SBH103001R8853	NSL53E-88	4/25	1SBL111001R1601	AS12-30-01-16	4/4
1SAZ711201R1009	T16-0.23	6/2	1SBH103001R8862	NSL62E-88	4/25	1SBL111001R1610	AS12-30-10-16	4/4
1SAZ711201R1013	T16-0.31	6/2	1SBH103001R8871	NSL71E-88	4/25	1SBL111001R1632	AS12-30-32-16	4/6
1SAZ711201R1014	T16-0.41	6/2	1SBH103001R8880	NSL80E-88	4/25	1SBL111001R2001	AS12-30-01-20	4/4
1SAZ711201R1017	T16-0.55	6/2	1SBH136001R2022	NFZ22E-20	5/109	1SBL111001R2010	AS12-30-10-20	4/4
1SAZ711201R1021	T16-0.74	6/2	1SBH136001R2031	NFZ31E-20	5/109	1SBL111001R2032	AS12-30-32-20	4/6
1SAZ711201R1023	T16-1.0	6/2	1SBH136001R2040	NFZ40E-20	5/109	1SBL111001R2601	AS12-30-01-26	4/4
1SAZ711201R1025	T16-1.3	6/2	1SBH136001R2122	NFZ22E-21	5/109	1SBL111001R2610	AS12-30-10-26	4/4
1SAZ711201R1028	T16-1.7	6/2	1SBH136001R2131	NFZ31E-21	5/109	1SBL111001R2632	AS12-30-32-26	4/6
1SAZ711201R1031	T16-2.3	6/2	1SBH136001R2140	NFZ40E-21	5/109	1SBL111001R2801	AS12-30-01-28	4/4
1SAZ711201R1033	T16-3.1	6/2	1SBH136001R2222	NFZ22E-22	5/109	1SBL111001R2810	AS12-30-10-28	4/4
1SAZ711201R1035	T16-4.2	6/2	1SBH136001R2231	NFZ31E-22	5/109	1SBL111001R2832	AS12-30-32-28	4/6
1SAZ711201R1038	T16-5.7	6/2	1SBH136001R2240	NFZ40E-22	5/109	1SBL113001R8101	ASL12-30-01-81	4/5
1SAZ711201R1040	T16-7.6	6/2	1SBH136001R2322	NFZ22E-23	5/109	1SBL113001R8132	ASL12-30-32-81	4/7
1SAZ711201R1043	T16-10	6/2	1SBH136001R2331	NFZ31E-23	5/109	1SBL113001R8301	ASL12-30-01-83	4/5
1SAZ711201R1045	T16-13	6/2	1SBH136001R2340	NFZ40E-23	5/109	1SBL113001R8310	ASL12-30-10-83	4/5
1SAZ711201R1047	T16-16	6/2	1SBH137001R1122	NF22E-11	5/108	1SBL113001R8330	ASL12-30-32-83	4/7
1SAZ721201R1005	TF42-0.13	6/6	1SBH137001R1131	NF31E-11	5/108	1SBL113001R8601	ASL12-30-01-86	4/5
1SAZ721201R1008	TF42-0.17	6/6	1SBH137001R1140	NF40E-11	5/108	1SBL113001R8610	ASL12-30-10-86	4/5
1SAZ721201R1009	TF42-0.23	6/6	1SBH137001R1222	NF22E-12	5/108	1SBL113001R8632	ASL12-30-32-86	4/7
1SAZ721201R1013	TF42-0.31	6/6	1SBH137001R1231	NF31E-12	5/108	1SBL113001R8801	ASL12-30-01-88	4/5
1SAZ721201R1014	TF42-0.41	6/6	1SBH137001R1240	NF40E-12	5/108	1SBL113001R8810	ASL12-30-10-88	4/5
1SAZ721201R1017	TF42-0.55	6/6	1SBH137001R1322	NF22E-13	5/108	1SBL113001R8832	ASL12-30-32-88	4/7
1SAZ721201R1021	TF42-0.74	6/6	1SBH137001R1331	NF31E-13	5/108	1SBL121001R1601	AS16-30-01-16	4/4
1SAZ721201R1023	TF42-1.0	6/6	1SBH137001R1340	NF40E-13	5/108	1SBL121001R1610	AS16-30-10-16	4/4
1SAZ721201R1025	TF42-1.3	6/6	1SBH137001R1422	NF22E-14	5/108	1SBL121001R1632	AS16-30-32-16	4/6
1SAZ721201R1028	TF42-1.7	6/6	1SBH137001R1431	NF31E-14	5/108	1SBK103600M1600	VAS09EM-16M	4/16
1SAZ721201R1031	TF42-2.3	6/6	1SBH137001R1440	NF40E-14	5/108	1SBK103600M2000	VAS09EM-20M	4/16
1SAZ721201R1033	TF42-3.1	6/6	1SBK103600M2600	VAS09EM-26M	4/16	1SBK103600M2800	VAS09EM-28M	4/16
1SAZ721201R1035	TF42-4.2	6/6	1SBK103700M8100	VASL09EM-81M	4/17	1SBK103700M8300	VASL09EM-83M	4/17
1SAZ721201R1038	TF42-5.7	6/6	1SBK103700M8600	VASL09EM-86M	4/17	1SBK103700M8800	VASL09EM-88M	4/17
1SAZ721201R1040	TF42-7.6	6/6	1SBK103800M1600	VAS12SEM-16M	4/16	1SBK103800M2000	VAS12SEM-20M	4/16
1SAZ721201R1043	TF42-10	6/6	1SBK103800M2600	VAS12SEM-26M	4/16			

Index

Order code classification

Order code	Type	Page	Order code	Type	Page	Order code	Type	Page
1SBL123001R8132	ASL16-30-32-81	4/7	1SBL181024R8410	UA16-30-10RA	5/96	1SBL321001R8801	A40-30-01	5/10
1SBL123001R8301	ASL16-30-01-83	4/5	1SBL181024R8510	UA16-30-10RA	5/96	1SBL321001R8810	A40-30-10	5/10
1SBL123001R8310	ASL16-30-10-83	4/5	1SBL181024R8610	UA16-30-10RA	5/96	1SBL323001R8001	AL40-30-01	5/12
1SBL123001R8332	ASL16-30-32-83	4/7	1SBL181024R8810	UA16-30-10RA	5/96	1SBL323001R8010	AL40-30-10	5/12
1SBL123001R8601	ASL16-30-01-86	4/5	1SBL236001R2000	AF26Z-30-00-20	5/7	1SBL323001R8101	AL40-30-01	5/12
1SBL123001R8610	ASL16-30-10-86	4/5	1SBL236001R2100	AF26Z-30-00-21	5/7	1SBL323001R8110	AL40-30-10	5/12
1SBL123001R8632	ASL16-30-32-86	4/7	1SBL236001R2200	AF26Z-30-00-22	5/7	1SBL323001R8301	AL40-30-01	5/12
1SBL123001R8801	ASL16-30-01-88	4/5	1SBL236001R2300	AF26Z-30-00-23	5/7	1SBL323001R8310	AL40-30-10	5/12
1SBL123001R8810	ASL16-30-10-88	4/5	1SBL236201R2000	AF26Z-40-00-20	5/59	1SBL323001R8401	AL40-30-01	5/12
1SBL123001R8832	ASL16-30-32-88	4/7	1SBL236201R2100	AF26Z-40-00-21	5/59	1SBL323001R8410	AL40-30-10	5/12
1SBL136001R2001	AF09Z-30-01-20	5/7	1SBL236201R2200	AF26Z-40-00-22	5/59	1SBL323001R8601	AL40-30-01	5/12
1SBL136001R2010	AF09Z-30-10-20	5/7	1SBL236201R2300	AF26Z-40-00-23	5/59	1SBL323001R8610	AL40-30-10	5/12
1SBL136001R2101	AF09Z-30-01-21	5/7	1SBL236501R2000	AF26Z-22-00-20	5/59	1SBL323001R8701	AL40-30-01	5/12
1SBL136001R2110	AF09Z-30-10-21	5/7	1SBL236501R2100	AF26Z-22-00-21	5/59	1SBL323001R8710	AL40-30-10	5/12
1SBL136001R2201	AF09Z-30-01-22	5/7	1SBL236501R2200	AF26Z-22-00-22	5/59	1SBL323001R8801	AL40-30-01	5/12
1SBL136001R2210	AF09Z-30-10-22	5/7	1SBL236501R2300	AF26Z-22-00-23	5/59	1SBL323001R8810	AL40-30-10	5/12
1SBL136001R2301	AF09Z-30-01-23	5/7	1SBL237001R1100	AF26-30-00-11	5/6	1SBL323001R8901	AL40-30-01	5/12
1SBL136001R2310	AF09Z-30-10-23	5/7	1SBL237001R1200	AF26-30-00-12	5/6	1SBL323001R8910	AL40-30-10	5/12
1SBL136201R2000	AF09Z-40-00-20	5/59	1SBL237001R1300	AF26-30-00-13	5/6	1SBL331201R8000	A45-40-00	5/63
1SBL136201R2100	AF09Z-40-00-21	5/59	1SBL237001R1400	AF26-30-00-14	5/6	1SBL331201R8100	A45-40-00	5/63
1SBL136201R2200	AF09Z-40-00-22	5/59	1SBL237201R1100	AF26-40-00-11	5/58	1SBL331201R8300	A45-40-00	5/63
1SBL136201R2300	AF09Z-40-00-23	5/59	1SBL237201R1200	AF26-40-00-12	5/58	1SBL331201R8400	A45-40-00	5/63
1SBL136501R2000	AF09Z-22-00-20	5/59	1SBL237201R1300	AF26-40-00-13	5/58	1SBL331201R8500	A45-40-00	5/63
1SBL136501R2100	AF09Z-22-00-21	5/59	1SBL237201R1400	AF26-40-00-14	5/58	1SBL331201R8600	A45-40-00	5/63
1SBL136501R2200	AF09Z-22-00-22	5/59	1SBL237501R1100	AF26-22-00-11	5/58	1SBL331201R8800	A45-40-00	5/63
1SBL136501R2300	AF09Z-22-00-23	5/59	1SBL237501R1200	AF26-22-00-12	5/58	1SBL331501R8000	A45-22-00	5/63
1SBL137001R1101	AF09-30-01-11	5/6	1SBL237501R1300	AF26-22-00-13	5/58	1SBL331501R8100	A45-22-00	5/63
1SBL137001R1110	AF09-30-10-11	5/6	1SBL237501R1400	AF26-22-00-14	5/58	1SBL331501R8300	A45-22-00	5/63
1SBL137001R1201	AF09-30-01-12	5/6	1SBL241022R8010	UA26-30-10	5/101	1SBL331501R8400	A45-22-00	5/63
1SBL137001R1210	AF09-30-10-12	5/6	1SBL241022R810	UA26-30-10	5/101	1SBL331501R8500	A45-22-00	5/63
1SBL137001R1301	AF09-30-01-13	5/6	1SBL241022R8310	UA26-30-10	5/101	1SBL331501R8600	A45-22-00	5/63
1SBL137001R1310	AF09-30-10-13	5/6	1SBL241022R8410	UA26-30-10	5/101	1SBL331501R8800	A45-22-00	5/63
1SBL137001R1401	AF09-30-01-14	5/6	1SBL241022R8510	UA26-30-10	5/101	1SBL337201R6900	AF45-40-00	5/65
1SBL137001R1410	AF09-30-10-14	5/6	1SBL241022R8610	UA26-30-10	5/101	1SBL337201R7000	AF45-40-00	5/65
1SBL137201R1100	AF09-40-00-11	5/58	1SBL241022R8810	UA26-30-10	5/101	1SBL337201R7200	AF45-40-00	5/65
1SBL137201R1200	AF09-40-00-12	5/58	1SBL241024R8010	UA26-30-10RA	5/96	1SBL337501R6900	AF45-22-00	5/65
1SBL137201R1300	AF09-40-00-13	5/58	1SBL241024R810	UA26-30-10RA	5/96	1SBL337501R7000	AF45-22-00	5/65
1SBL137201R1400	AF09-40-00-14	5/58	1SBL241024R8310	UA26-30-10RA	5/96	1SBL339201R8000	AE45-40-00	5/64
1SBL137501R1100	AF09-22-00-11	5/58	1SBL241024R8410	UA26-30-10RA	5/96	1SBL339201R8100	AE45-40-00	5/64
1SBL137501R1200	AF09-22-00-12	5/58	1SBL241024R8510	UA26-30-10RA	5/96	1SBL339201R8300	AE45-40-00	5/64
1SBL137501R1300	AF09-22-00-13	5/58	1SBL241024R8610	UA26-30-10RA	5/96	1SBL339201R8400	AE45-40-00	5/64
1SBL137501R1400	AF09-22-00-14	5/58	1SBL241024R8810	UA26-30-10RA	5/96	1SBL339201R8600	AE45-40-00	5/64
1SBL156001R2001	AF12Z-30-01-20	5/7	1SBL276001R2000	AF30Z-30-00-20	5/7	1SBL339201R8700	AE45-40-00	5/64
1SBL156001R2010	AF12Z-30-10-20	5/7	1SBL276001R2100	AF30Z-30-00-21	5/7	1SBL339201R8800	AE45-40-00	5/64
1SBL156001R2101	AF12Z-30-01-21	5/7	1SBL276001R2200	AF30Z-30-00-22	5/7	1SBL339201R8900	AE45-40-00	5/64
1SBL156001R2110	AF12Z-30-10-21	5/7	1SBL276001R2300	AF30Z-30-00-23	5/7	1SBL339501R8000	AE45-22-00	5/64
1SBL156001R2201	AF12Z-30-01-22	5/7	1SBL277001R1100	AF30-30-00-11	5/6	1SBL339501R8100	AE45-22-00	5/64
1SBL156001R2210	AF12Z-30-10-22	5/7	1SBL277001R1200	AF30-30-00-12	5/6	1SBL339501R8300	AE45-22-00	5/64
1SBL156001R2301	AF12Z-30-01-23	5/7	1SBL277001R1300	AF30-30-00-13	5/6	1SBL339501R8400	AE45-22-00	5/64
1SBL156001R2310	AF12Z-30-10-23	5/7	1SBL277001R1400	AF30-30-00-14	5/6	1SBL339501R8600	AE45-22-00	5/64
1SBL157001R1101	AF12-30-01-11	5/6	1SBL281022R8010	UA30-30-10	5/101	1SBL339501R8800	AE45-22-00	5/64
1SBL157001R1110	AF12-30-10-11	5/6	1SBL281022R810	UA30-30-10	5/101	1SBL339501R8700	AE45-22-00	5/64
1SBL157001R1201	AF12-30-01-12	5/6	1SBL281022R8310	UA30-30-10	5/101	1SBL339501R8800	AE45-22-00	5/64
1SBL157001R1210	AF12-30-10-12	5/6	1SBL281022R8410	UA30-30-10	5/101	1SBL339501R8900	AE45-22-00	5/64
1SBL157001R1301	AF12-30-01-13	5/6	1SBL281022R8510	UA30-30-10	5/101	1SBL351001R8000	A50-30-00	5/11
1SBL157001R1310	AF12-30-10-13	5/6	1SBL281022R8610	UA30-30-10	5/101	1SBL351001R8100	A50-30-00	5/11
1SBL157001R1401	AF12-30-01-14	5/6	1SBL281022R8810	UA30-30-10	5/101	1SBL351001R8300	A50-30-00	5/11
1SBL157001R1410	AF12-30-10-14	5/6	1SBL281024R8010	UA30-30-10RA	5/96	1SBL351001R8400	A50-30-00	5/11
1SBL176001R2001	AF16Z-30-01-20	5/7	1SBL281024R8110	UA30-30-10RA	5/96	1SBL351001R8500	A50-30-00	5/11
1SBL176001R2010	AF16Z-30-10-20	5/7	1SBL281024R8310	UA30-30-10RA	5/96	1SBL351001R8600	A50-30-00	5/11
1SBL176001R2101	AF16Z-30-01-21	5/7	1SBL281024R8410	UA30-30-10RA	5/96	1SBL351001R8800	A50-30-00	5/11
1SBL176001R2110	AF16Z-30-10-21	5/7	1SBL281024R8510	UA30-30-10RA	5/96	1SBL351022R8000	UA50-30-00	5/102
1SBL176001R2201	AF16Z-30-01-22	5/7	1SBL281024R8610	UA30-30-10RA	5/96	1SBL351022R8100	UA50-30-00	5/102
1SBL176001R2210	AF16Z-30-10-22	5/7	1SBL281024R8810	UA30-30-10RA	5/96	1SBL351022R8300	UA50-30-00	5/102
1SBL176001R2301	AF16Z-30-01-23	5/7	1SBL296001R2000	AF38Z-30-00-20	5/7	1SBL351022R8400	UA50-30-00	5/102
1SBL176001R2310	AF16Z-30-10-23	5/7	1SBL296001R2100	AF38Z-30-00-21	5/7	1SBL351022R8500	UA50-30-00	5/102
1SBL176201R2000	AF16Z-40-00-20	5/59	1SBL296001R2200	AF38Z-30-00-22	5/7	1SBL351022R8600	UA50-30-00	5/102
1SBL176201R2100	AF16Z-40-00-21	5/59	1SBL296001R2300	AF38Z-30-00-23	5/7	1SBL351022R8800	UA50-30-00	5/102
1SBL176201R2200	AF16Z-40-00-22	5/59	1SBL296201R2000	AF38Z-40-00-20	5/59	1SBL351024R8000	UA50-30-00RA	5/97
1SBL176201R2300	AF16Z-40-00-23	5/59	1SBL296201R2100	AF38Z-40-00-21	5/59	1SBL351024R8100	UA50-30-00RA	5/97
1SBL176501R2000	AF16Z-22-00-20	5/59	1SBL296201R2200	AF38Z-40-00-22	5/59	1SBL351024R8300	UA50-30-00RA	5/97
1SBL176501R2100	AF16Z-22-00-21	5/59	1SBL296201R2300	AF38Z-40-00-23	5/59	1SBL351024R8400	UA50-30-00RA	5/97
1SBL176501R2200	AF16Z-22-00-22	5/59	1SBL296501R2000	AF38Z-22-00-20	5/59	1SBL351024R8500	UA50-30-00RA	5/97
1SBL176501R2300	AF16Z-22-00-23	5/59	1SBL296501R2100	AF38Z-22-00-21	5/59	1SBL351024R8600	UA50-30-00RA	5/97
1SBL177001R1101	AF16-30-01-11	5/6	1SBL296501R2200	AF38Z-22-00-22	5/59	1SBL351024R8800	UA50-30-00RA	5/97
1SBL177001R1110	AF16-30-10-11	5/6	1SBL296501R2300	AF38Z-22-00-23	5/59	1SBL351201R8000	A50-40-00	5/63
1SBL177001R1201	AF16-30-01-12	5/6	1SBL297001R1100	AF38-30-00-11	5/6	1SBL351201R8100	A50-40-00	5/63
1SBL177001R1210	AF16-30-10-12	5/6	1SBL297001R1200	AF38-30-00-12	5/6	1SBL351201R8300	A50-40-00	5/63
1SBL177001R1301	AF16-30-01-13	5/6	1SBL297001R1300	AF38-30-00-13	5/6	1SBL351201R8400	A50-40-00	5/63
1SBL177001R1310	AF16-30-10-13	5/6	1SBL297001R1400	AF38-30-00-14	5/6	1SBL351201R8500	A50-40-00	5/63
1SBL177001R1401	AF16-30-01-14	5/6	1SBL297201R1100	AF38-40-00-11	5/58	1SBL351201R8600	A50-40-00	5/63
1SBL177001R1410	AF16-30-10-14	5/6	1SBL297201R1200	AF38-40-00-12	5/58	1SBL351201R8800	A50-40-00	5/63
1SBL177201R1100	AF16-40-00-11	5/58	1SBL297201R1300	AF38-40-00-13	5/58	1SBL357001R6900	AF50-30-00	5/14
1SBL177201R1200	AF16-40-00-12	5/58	1SBL297201R1400	AF38-40-00-14	5/58	1SBL357001R7000	AF50-30-00	5/14
1SBL177201R1300	AF16-40-00-13	5/58	1SBL297501R1100	AF38-22-00-11	5/58	1SBL357201R6900	AF50-40-00	5/65
1SBL177201R1400	AF16-40-00-14	5/58	1SBL297501R1200	AF38-22-00-12	5/58	1SBL357201R7000	AF50-40-00	5/65
1SBL177501R1100	AF16-22-00-11	5/58	1SBL297501R1300	AF38-22-00-13	5/58	1SBL357201R7200	AF50-40-00	5/65
1SBL177501R1200	AF16-22-00-12	5/58	1SBL297501R1400	AF38-22-00-14	5/58	1SBL359001R8000	AE50-30-00	5/13
1SBL177501R1300	AF16-22-00-13	5/58	1SBL321001R8001	A40-30-01	5/10	1SBL359001R8100	AE50-30-00	5/13
1SBL177501R1400	AF16-22-00-14	5/58	1SBL321001R8010	A40-30-10	5/10</			

Index

Order code classification

Order code	Type	Page
1SBL359201R8600	AE50-40-00	5/64
1SBL359201R8700	AE50-40-00	5/64
1SBL359201R8800	AE50-40-00	5/64
1SBL359201R8900	AE50-40-00	5/64
1SBL371001R8000	A63-30-00	5/11
1SBL371001R8100	A63-30-00	5/11
1SBL371001R8300	A63-30-00	5/11
1SBL371001R8400	A63-30-00	5/11
1SBL371001R8500	A63-30-00	5/11
1SBL371001R8600	A63-30-00	5/11
1SBL371001R8800	A63-30-00	5/11
1SBL371022R8000	UA63-30-00	5/102
1SBL371022R8100	UA63-30-00	5/102
1SBL371022R8300	UA63-30-00	5/102
1SBL371022R8400	UA63-30-00	5/102
1SBL371022R8500	UA63-30-00	5/102
1SBL371022R8600	UA63-30-00	5/102
1SBL371022R8800	UA63-30-00	5/102
1SBL371024R8000	UA63-30-00RA	5/97
1SBL371024R8100	UA63-30-00RA	5/97
1SBL371024R8300	UA63-30-00RA	5/97
1SBL371024R8400	UA63-30-00RA	5/97
1SBL371024R8500	UA63-30-00RA	5/97
1SBL371024R8600	UA63-30-00RA	5/97
1SBL371024R8800	UA63-30-00RA	5/97
1SBL377001R6900	AF63-30-00	5/14
1SBL377001R7000	AF63-30-00	5/14
1SBL377001R7200	AF63-30-00	5/14
1SBL379001R8000	AE63-30-00	5/13
1SBL379001R8100	AE63-30-00	5/13
1SBL379001R8300	AE63-30-00	5/13
1SBL379001R8400	AE63-30-00	5/13
1SBL379001R8600	AE63-30-00	5/13
1SBL379001R8700	AE63-30-00	5/13
1SBL379001R8800	AE63-30-00	5/13
1SBL379001R8900	AE63-30-00	5/13
1SBL411001R8000	A75-30-00	5/11
1SBL411001R8100	A75-30-00	5/11
1SBL411001R8300	A75-30-00	5/11
1SBL411001R8400	A75-30-00	5/11
1SBL411001R8500	A75-30-00	5/11
1SBL411001R8600	A75-30-00	5/11
1SBL411001R8800	A75-30-00	5/11
1SBL411022R8000	UA75-30-00	5/102
1SBL411022R8100	UA75-30-00	5/102
1SBL411022R8300	UA75-30-00	5/102
1SBL411022R8400	UA75-30-00	5/102
1SBL411022R8500	UA75-30-00	5/102
1SBL411022R8600	UA75-30-00	5/102
1SBL411022R8800	UA75-30-00	5/102
1SBL411024R8000	UA75-30-00RA	5/97
1SBL411024R8100	UA75-30-00RA	5/97
1SBL411024R8300	UA75-30-00RA	5/97
1SBL411024R8400	UA75-30-00RA	5/97
1SBL411024R8500	UA75-30-00RA	5/97
1SBL411024R8600	UA75-30-00RA	5/97
1SBL411024R8800	UA75-30-00RA	5/97
1SBL411201R8000	A75-40-00	5/63
1SBL411201R8100	A75-40-00	5/63
1SBL411201R8300	A75-40-00	5/63
1SBL411201R8400	A75-40-00	5/63
1SBL411201R8500	A75-40-00	5/63
1SBL411201R8600	A75-40-00	5/63
1SBL411201R8800	A75-40-00	5/63
1SBL411501R8000	A75-22-00	5/63
1SBL411501R8100	A75-22-00	5/63
1SBL411501R8300	A75-22-00	5/63
1SBL411501R8400	A75-22-00	5/63
1SBL411501R8500	A75-22-00	5/63
1SBL411501R8600	A75-22-00	5/63
1SBL411501R8800	A75-22-00	5/63
1SBL417001R6900	AF75-30-00	5/14
1SBL417001R7000	AF75-30-00	5/14
1SBL417001R7200	AF75-30-00	5/14
1SBL417201R6900	AF75-40-00	5/65
1SBL417201R7000	AF75-40-00	5/65
1SBL417201R7200	AF75-40-00	5/65
1SBL417501R6900	AF75-22-00	5/65
1SBL417501R7000	AF75-22-00	5/65
1SBL417501R7200	AF75-22-00	5/65
1SBL419001R8000	AE75-30-00	5/13
1SBL419001R8100	AE75-30-00	5/13
1SBL419001R8300	AE75-30-00	5/13
1SBL419001R8400	AE75-30-00	5/13
1SBL419001R8600	AE75-30-00	5/13
1SBL419001R8700	AE75-30-00	5/13
1SBL419001R8800	AE75-30-00	5/13
1SBL419001R8900	AE75-30-00	5/13
1SBL419201R8000	AE75-40-00	5/64
1SBL419201R8100	AE75-40-00	5/64
1SBL419201R8300	AE75-40-00	5/64
1SBL419201R8400	AE75-40-00	5/64
1SBL419201R8600	AE75-40-00	5/64
1SBL419201R8700	AE75-40-00	5/64
1SBL419201R8800	AE75-40-00	5/64
1SBL419201R8900	AE75-40-00	5/64
1SBL419501R8000	AE75-22-00	5/64
1SBL419501R8100	AE75-22-00	5/64
1SBL419501R8300	AE75-22-00	5/64
1SBL419501R8400	AE75-22-00	5/64

Order code	Type	Page
1SBL419501R8600	AE75-22-00	5/64
1SBL419501R8700	AE75-22-00	5/64
1SBL419501R8800	AE75-22-00	5/64
1SBL419501R8900	AE75-22-00	5/64
1SBN010010R1001	CA5-01	5/122
1SBN010010R1010	CA5-10	5/122
1SBN010011R1001	CC5-01	5/122
1SBN010011R1010	CC5-10	5/122
1SBN010020R1011	CAL5-11	5/122
1SBN010040R1004	CA5-04E	5/122
1SBN010040R1018	CA5-11/11E	5/122
1SBN010040R1022	CA5-22E	5/122
1SBN010040R1031	CA5-31E	5/122
1SBN010040R1040	CA5-40E	5/122
1SBN010040R1104	CA5-04M	5/122
1SBN010040R1113	CA5-13M	5/122
1SBN010040R1118	CA5-11/11M	5/122
1SBN010040R1122	CA5-22M	5/122
1SBN010040R1131	CA5-31M	5/122
1SBN010040R1304	CA5-04U	5/122
1SBN010040R1322	CA5-22U	5/122
1SBN010040R1331	CA5-31U	5/122
1SBN010040R1340	CA5-40U	5/122
1SBN010110R1001	CA4-01	5/116
1SBN010110R1010	CA4-10	5/116
1SBN010110T1001	CA4-01-T	5/116
1SBN010110T1010	CA4-10-T	5/116
1SBN010111R1001	CC4-01	5/116
1SBN010111R1010	CC4-10	5/116
1SBN010120R1011	CAL4-11	5/116
1SBN010120T1011	CAL4-11-T	5/116
1SBN010140R1004	CA4-04E	5/116
1SBN010140R1022	CA4-22E	5/116
1SBN010140R1031	CA4-31E	5/116
1SBN010140R1040	CA4-40E	5/116
1SBN010140R1104	CA4-04M	5/116
1SBN010140R1113	CA4-13M	5/116
1SBN010140R1122	CA4-22M	5/116
1SBN010140R1131	CA4-31M	5/116
1SBN010140R1204	CA4-04N	5/116
1SBN010140R1213	CA4-13N	5/116
1SBN010140R1222	CA4-22N	5/116
1SBN010140R1231	CA4-31N	5/116
1SBN010140R1240	CA4-40N	5/116
1SBN010140R1322	CA4-22U	5/116
1SBN010140R1331	CA4-31U	5/116
1SBN010140R1340	CA4-40U	5/116
1SBN010151R1011	CAT4-11E	5/116
1SBN010151R1111	CAT4-11M	5/116
1SBN010151R1311	CAT4-11U	5/116
1SBN011010T1001	CA3-01	4/9
1SBN011010T1010	CA3-10	4/9
1SBN020010R1001	TESS-24	5/126
1SBN020010R1002	TESS-120	5/126
1SBN020010R1003	TESS-240	5/126
1SBN020010R1004	TESS-440	5/126
1SBN020300R1000	TP40DA	5/123
1SBN020300R1001	TP180DA	5/123
1SBN020301R1000	TP40IA	5/123
1SBN020301R1001	TP180IA	5/123
1SBN021012R1000	TEF3-ON	4/9
1SBN021014R1000	TEF3-OFF	4/9
1SBN030100R1000	VM5-1	5/124
1SBN030105T1000	VM4	5/117
1SBN030110R1000	VE5-1	5/124
1SBN030111R1000	VE4	5/117
1SBN030210R1000	VE5-2	5/124
1SBN031005T1000	VM3	4/9
1SBN050010R1000	RV5/50	5/127
1SBN050010R1001	RV5/133	5/127
1SBN050010R1002	RV5/250	5/127
1SBN050010R1003	RV5/440	5/127
1SBN050020R1000	RT5/32	5/127
1SBN050020R1001	RT5/65	5/127
1SBN050020R1002	RT5/90	5/127
1SBN050020R1003	RT5/150	5/127
1SBN050020R1004	RT5/264	5/127
1SBN050100R1000	RC5-1/50	5/127
1SBN050100R1001	RC5-1/133	5/127
1SBN050100R1002	RC5-1/250	5/127
1SBN050100R1003	RC5-1/440	5/127
1SBN050200R1000	RC5-2/50	5/127
1SBN050200R1001	RC5-2/133	5/127
1SBN050200R1002	RC5-2/250	5/127
1SBN050200R1003	RC5-2/440	5/127
1SBN060300R1000	RA5-1	5/128
1SBN060300T1000	RA5-1	5/128
1SBN070156T1000	LDC4	5/120
1SBN071303T1000	LY16-4	5/120
1SBN072303T1000	LY38-4	5/120
1SBN072808R1000	LD40	5/130
1SBN073205R1000	LF40	5/135
1SBN073508R1000	LD75	5/130
1SBN073552R1002	LK75-F	5/131
1SBN073552R1003	LK75-L	5/131
1SBN080906R1001	BEA7/325	3/24
1SBN080906R1002	BEA7/132	3/24
1SBN081006T1000	BEA16-3	4/9
1SBN081012R1000	BEA16C-3	4/9
1SBN081018R2000	BEY16C-3	4/9

Order code	Type	Page
1SBN081306T1000	BEA16-4	5/119
1SBN081311R1000	BER16-4	5/119
1SBN081313R2000	BEY16-4	5/119
1SBN082306T1000	BEA26-4	5/119
1SBN082306T2000	BEA38-4	5/119
1SBN082311R1000	BER38-4	5/119
1SBN082411R1000	BER40V	5/139
1SBN082713R2000	BEY38-4	5/119
1SBN083206R1000	BEA40/450	5/136
1SBN083302R1000	BES75-40	5/139
1SBN083501R1000	BEM75-30	5/139
1SBN083503R1000	BED50	5/140
1SBN083503R1001	BED50-1	5/140
1SBN083504R1000	BES75-30	5/139
1SBN083506R1000	BEA50/450	5/136
1SBN084103R1000	BED75	5/140
1SBN084103R1001	BED75-1	5/140
1SBN084106R1000	BEA75/495	5/136
1SBN084506R1000	BEA110/495	5/136
1SBN110000R1000	BA5-50	5/125
1SBN110108T1000	BX4	5/120
1SBN110109W1000	BX4-CA	5/120
1SBN110120W1000	BB4	5/117
1SBN111020R1000	BB3	4/35
1SBN111403R1000	BP16	5/125
1SBN112303T1000	BP38-4	5/120
1SBN151410R8000	ZA16	5/144
1SBN151410R8106	ZA16	5/144
1SBN151410R8306	ZA16	5/144
1SBN151410R8406	ZA16	5/144
1SBN151410R8506	ZA16	5/144
1SBN151410R8606	ZA16	5/144
1SBN151410R8806	ZA16	5/144
1SBN152410R8006	ZA40	5/144
1SBN152410R8106	ZA40	5/144
1SBN152410R8306	ZA40	5/144
1SBN152410R8406	ZA40	5/144
1SBN152410R8506	ZA40	5/144
1SBN152410R8606	ZA40	5/144
1SBN152410R8806	ZA40	5/144
1SBN153510R8006	ZA75	5/144
1SBN153510R8106	ZA75	5/144
1SBN153510R8306	ZA75	5/144
1SBN153510R8406	ZA75	5/144
1SBN153510R8506	ZA75	5/144
1SBN153510R8606	ZA75	5/144
1SBN153510R8806	ZA75	5/144
1SBN153570R7006	ZAF75	5/145
1SBN153570R7206	ZAF75	5/145
1SBN163502R1000	ZLU50	5/143
1SBN163503R1000	ZLU50	5/143
1SBN163702R1000	ZLU63	5/143
1SBN163703R1000	ZL63	5/143
1SBN164102R1000	ZLU75	5/143
1SBN164103R1000	ZL75	5/143
1SCA022509R0120	OSZA15	5/138
1SCA101647R1001	OXSGX85	2/9
1SCA101655R1001	OXSGX130	2/9
1SCA101659R1001	OXSGX180	2/9
1SCA108043R1001	OXSGX105	2/9
1SDA023354R0001	-	5/134
1SDA023356R0001	-	5/134
1SDA023357R0001	-	5/134
1SDA023368R0001	-	5/134
1SDA023370R0001	-	5/134
1SDA023380R0001	-	5/134
1SDA023384R0001	-	5/134
1SDA023387R0001	-	5/134
1SDA025766R0001	-	

Index

Order code classification

Order code	Type	Page
1SFL451001R8600	A110-30-00	5/18
1SFL451001R8800	A110-30-00	5/18
1SFL451022R8000	UA110-30-00	5/103
1SFL451022R8100	UA110-30-00	5/103
1SFL451022R8300	UA110-30-00	5/103
1SFL451022R8400	UA110-30-00	5/103
1SFL451022R8500	UA110-30-00	5/103
1SFL451022R8600	UA110-30-00	5/103
1SFL451022R8800	UA110-30-00	5/103
1SFL451024R8000	UA110-30-00RA	5/98
1SFL451024R8100	UA110-30-00RA	5/98
1SFL451024R8300	UA110-30-00RA	5/98
1SFL451024R8400	UA110-30-00RA	5/98
1SFL451024R8500	UA110-30-00RA	5/98
1SFL451024R8600	UA110-30-00RA	5/98
1SFL451024R8800	UA110-30-00RA	5/98
1SFL457001R6900	AF110-30-00	5/19
1SFL457001R7000	AF110-30-00	5/19
1SFL457001R7200	AF110-30-00	5/19
1SFL471001R8011	A145-30-11	5/22
1SFL471001R8111	A145-30-11	5/22
1SFL471001R8311	A145-30-11	5/22
1SFL471001R8411	A145-30-11	5/22
1SFL471001R8511	A145-30-11	5/22
1SFL471001R8611	A145-30-11	5/22
1SFL471001R8811	A145-30-11	5/22
1SFL471001R8811	A145-30-11	5/22
1SFL477001R6911	AF145-30-11	5/23
1SFL477001R7011	AF145-30-11	5/23
1SFL477001R7211	AF145-30-11	5/23
1SFL491001R8011	A185-30-11	5/22
1SFL491001R8111	A185-30-11	5/22
1SFL491001R8311	A185-30-11	5/22
1SFL491001R8411	A185-30-11	5/22
1SFL491001R8511	A185-30-11	5/22
1SFL491001R8611	A185-30-11	5/22
1SFL491001R8811	A185-30-11	5/22
1SFL497001R6911	AF185-30-11	5/23
1SFL497001R7011	AF185-30-11	5/23
1SFL497001R7211	AF185-30-11	5/23
1SFL511001R8011	A210-30-11	5/22
1SFL511001R8111	A210-30-11	5/22
1SFL511001R8311	A210-30-11	5/22
1SFL511001R8411	A210-30-11	5/22
1SFL511001R8511	A210-30-11	5/22
1SFL511001R8611	A210-30-11	5/22
1SFL511001R8811	A210-30-11	5/22
1SFL517001R6911	AF210-30-11	5/23
1SFL517001R7011	AF210-30-11	5/23
1SFL517001R7211	AF210-30-11	5/23
1SFL531001R8011	A260-30-11	5/22
1SFL531001R8111	A260-30-11	5/22
1SFL531001R8311	A260-30-11	5/22
1SFL531001R8411	A260-30-11	5/22
1SFL531001R8511	A260-30-11	5/22
1SFL531001R8611	A260-30-11	5/22
1SFL531001R8811	A260-30-11	5/22
1SFL537001R6911	AF260-30-11	5/23
1SFL537001R7011	AF260-30-11	5/23
1SFL537001R7211	AF260-30-11	5/23
1SFL551001R8011	A300-30-11	5/22
1SFL551001R8111	A300-30-11	5/22
1SFL551001R8311	A300-30-11	5/22
1SFL551001R8411	A300-30-11	5/22
1SFL551001R8511	A300-30-11	5/22
1SFL551001R8611	A300-30-11	5/22
1SFL551001R8811	A300-30-11	5/22
1SFL557001R6911	AF300-30-11	5/23
1SFL557001R7011	AF300-30-11	5/23
1SFL557001R7211	AF300-30-11	5/23
1SFL577001R6811	AF400-30-11	5/24
1SFL577001R6911	AF400-30-11	5/24
1SFL577001R7011	AF400-30-11	5/24
1SFL577001R7111	AF400-30-11	5/24
1SFL597001R6811	AF460-30-11	5/24
1SFL597001R6911	AF460-30-11	5/24
1SFL597001R7011	AF460-30-11	5/24
1SFL597001R7111	AF460-30-11	5/24
1SFL617001R6811	AF580-30-11	5/24
1SFL617001R6911	AF580-30-11	5/24
1SFL617001R7011	AF580-30-11	5/24
1SFL617001R7111	AF580-30-11	5/24
1SFL637001R6811	AF750-30-11	5/24
1SFL637001R6911	AF750-30-11	5/24
1SFL637001R7011	AF750-30-11	5/24
1SFL637001R7111	AF750-30-11	5/24
1SFL647001R6811	AF1250-30-11	5/25
1SFL647001R6911	AF1250-30-11	5/25
1SFL647001R7011	AF1250-30-11	5/25
1SFL647001R7111	AF1250-30-11	5/25
1SFL657001R7011	AF1350-30-11	5/25
1SFL677001R7011	AF1650-30-11	5/25
1SFL707001R7011	AF2050-30-11	5/25
1SFN010720R1011	CAL18-11	5/122
1SFN010720R3311	CAL18-11B	5/122
1SFN034700R1000	VM300H	5/124
1SFN034701R1000	VM300V	5/124
1SFN035100R1000	VM300/460H	5/124
1SFN035101R1000	VM300/460V	5/124
1SFN035700R1000	VM750H	5/124
1SFN035701R1000	VM750V	5/124

Order code	Type	Page
1SFN036503R1000	VM1650H	5/124
1SFN050300R1003	RC5-3/440	5/127
1SFN074303R1000	LY110	5/135
1SFN074307R1000	LW110	5/133
1SFN074308R1000	LD110	5/130
1SFN074352R1000	LK110	5/131
1SFN074703R1000	LY185	5/135
1SFN074707R1000	LW185	5/133
1SFN074709R1000	LZ185-2C/120	5/134
1SFN074710R1000	LX185	5/133
1SFN074712R1000	LP185	5/135
1SFN075103R1000	LY300	5/135
1SFN075107R1000	LW300	5/133
1SFN075110R1000	LX300	5/133
1SFN075112R1000	LP300	5/135
1SFN075703R1000	LY460	5/135
1SFN075707R1000	LW460	5/133
1SFN075710R1000	LX460	5/133
1SFN075712R1000	LP460	5/135
1SFN076103R1000	LY750	5/135
1SFN076107R1000	LW750	5/133
1SFN076110R1000	LX750	5/133
1SFN076112R1000	LP750	5/135
1SFN076407R1000	LW1250	5/133
1SFN084301R1000	BEM110-30	5/139
1SFN084303R1000	BED95	5/140
1SFN084304R1000	BES110	5/139
1SFN084503R1000	BED110	5/140
1SFN084701R1000	BEM185-30	5/139
1SFN084703R1000	BED145A	5/140
1SFN084704R1000	BES185	5/139
1SFN084706R1003	BEA185/T3	5/137
1SFN084706R1004	BEA185D/T3	5/137
1SFN084706R1005	BEA185/T4	5/137
1SFN084706R1006	BEA185D/T4	5/137
1SFN084709R1000	BEF185H/OESA250	5/138
1SFN084903R1000	BED185	5/140
1SFN084908R1000	BEF185/OESA250	5/138
1SFN085101R1000	BEM300-30	5/139
1SFN085103R1000	BED210	5/140
1SFN085104R1000	BES300	5/139
1SFN085106R1003	BEA210/T4	5/137
1SFN085106R1004	BEA300/T5	5/137
1SFN085106R1005	BEA210D/T4	5/137
1SFN085108R1000	BEF300/OESA400	5/138
1SFN085109R1000	BEF300H/OESA400	5/138
1SFN085303R1000	BED300	5/140
1SFN085307R1002	BEA300H/T5	5/137
1SFN085503R1000	BED400	5/140
1SFN085506R1003	BEA300D/T5	5/137
1SFN085701R1000	BEM460-30	5/139
1SFN085703R1000	BED460	5/140
1SFN085704R1000	BES460	5/139
1SFN085708R1000	BEF460/OESA400	5/138
1SFN085709R1000	OESA460H/OESA400	5/138
1SFN085903R1000	BED580	5/140
1SFN085907R1000	BEA460H/T4	5/137
1SFN086101R1000	BEM750-30	5/139
1SFN086103R1000	BED750	5/140
1SFN086104R1000	BES750	5/139
1SFN086106R1000	BEA750/T6	5/137
1SFN086106R1001	BEA750/T5	5/137
1SFN086106R1002	BEA750D/T6	5/137
1SFN086106R1003	BEA750D/T5	5/137
1SFN086108R1000	BEF750/OESA800	5/138
1SFN094301R1000	PN110-21	5/141
1SFN094303R1000	PN110-41	5/141
1SFN094500R1000	PR110-1	5/142
1SFN094700R1000	PR145-1	5/142
1SFN094701R1000	PN185-21	5/141
1SFN094705R1000	PN185-11	5/141
1SFN094900R1000	PR210-1	5/142
1SFN094903R1000	PN185-41	5/141
1SFN095100R1001	PR185-2	5/142
1SFN095101R1000	PN300-21	5/141
1SFN095105R1000	PN300A-11	5/141
1SFN095300R1000	PR300-1	5/142
1SFN095300R1001	PR300-2	5/142
1SFN095503R1000	PN300-41	5/141
1SFN095700R1000	PR460-1	5/142
1SFN095700R1001	PR460-2	5/142
1SFN095701R1000	PN460-21	5/141
1SFN095703R1000	PN460-41	5/141
1SFN095705R1000	PN460-11	5/141
1SFN096100R1000	PR750-1	5/142
1SFN096100R1001	PR750-2	5/142
1SFN096100R1002	PR580-2	5/142
1SFN096101R1000	PN750-21	5/141
1SFN096103R1000	PN750-41	5/141
1SFN096105R1000	PN750-11	5/141
1SFN124701R1000	LT185-AC	5/132
1SFN124703R1000	LT185-AL	5/132
1SFN124704R1000	LT185-AY	5/132
1SFN125101R1000	LT300-AC	5/132
1SFN125103R1000	LT300-AL	5/132
1SFN125104R1000	LT300-AY	5/132
1SFN125701R1000	LT460-AC	5/132
1SFN125703R1000	LT460-AL	5/132
1SFN126101R1000	LT750-AC	5/132

Order code	Type	Page
1SFN126103R1000	LT750-AL	5/132
1SFN154310R8000	ZA110	5/144
1SFN154310R8100	ZA110	5/144
1SFN154310R8300	ZA110	5/144
1SFN154310R8400	ZA110	5/144
1SFN154310R8500	ZA110	5/144
1SFN154310R8600	ZA110	5/144
1SFN154310R8800	ZA110	5/144
1SFN154370R6900	ZAF110	5/145
1SFN154370R7000	ZAF110	5/145
1SFN154370R7200	ZAF110	5/145
1SFN154710R8000	ZA185	5/144
1SFN154710R8100	ZA185	5/144
1SFN154710R8300	ZA185	5/144
1SFN154710R8400	ZA185	5/144
1SFN154710R8500	ZA185	5/144
1SFN154710R8600	ZA185	5/144
1SFN154710R8800	ZA185	5/144
1SFN154770R6900	ZAF185	5/145
1SFN154770R7000	ZAF185	5/145
1SFN154770R7200	ZAF185	5/145
1SFN155110R8000	ZA300	5/144
1SFN155110R8100	ZA300	5/144
1SFN155110R8300	ZA300	5/144
1SFN155110R8400	ZA300	5/144
1SFN155110R8500	ZA300	5/144
1SFN155110R8600	ZA300	5/144
1SFN155110R8800	ZA300	5/144
1SFN155170R6900	ZAF300	5/145
1SFN155170R7000	ZAF300	5/145
1SFN155170R7200	ZAF300	5/145
1SFN155770R6800	ZAF460	5/145
1SFN155770R6900	ZAF460	5/145
1SFN155770R7000	ZAF460	5/145
1SFN155770R7100	ZAF460	5/145
1SFN156170R6800	ZAF750	5/145
1SFN156170R6900	ZAF750	5/145
1SFN156170R7000	ZAF750	5/145
1SFN156170R7100	ZAF750	5/145
1SFN156570R7026	ZAF1650	5/145
1SFN164302R1000	ZLU95	5/143
1SFN164303R1000	ZL95	5/143
1SFN164502R1000	ZLU110	5/143
1SFN164503R1000	ZL110	5/143
1SFN164703R1000	ZL145	5/143
1SFN164710R1000	ZW185	5/143
1SFN164903R1000	ZL185	5/143
1SFN165103R1000	ZL210	5/143
1SFN165110R1000	ZW300	5/143
1SFN165303R1000	ZL260	5/143
1SFN165503R1000	ZL300	5/143
1SFN165703R1000	ZL400	5/143
1SFN165710R1000	ZW460	5/143
1SFN165903R1000	ZL460	5/143
1SFN166103R1000	ZL580	5/143
1SFN166110R1000	ZW750	5/143
1SFN166303R1000	ZL750	5/143
1SFN166403R1000	ZL1250	5/143
1SFN166503R1000	ZL1350	5/143
1SFN166510R1000	ZW1650	5/143
1SFN166521R1070	ZP1650	5/145
1SFN166703R1000	ZL1650	5/143
1SFN167003R1000	ZL2050	5/143
1SNA235156R2700	BA4	5/120
1SNA235712R2400	HTP500-BA4	

Index

Order code classification

Order code	Type	Page
GJH1211001R0402	K6-40E-02	3/12
GJH1211001R0403	K6-40E-03	3/12
GJH1211001R8220	K6-22Z-80	3/12
GJH1211001R8224	K6-22Z-84	3/12
GJH1211001R8225	K6-22Z-85	3/12
GJH1211001R8310	K6-31Z-80	3/12
GJH1211001R8314	K6-31Z-84	3/12
GJH1211001R8315	K6-31Z-85	3/12
GJH1211001R8400	K6-40E-80	3/12
GJH1211001R8404	K6-40E-84	3/12
GJH1211001R8405	K6-40E-85	3/12
GJH1211009R0221	K6-22Z-P-01	3/20
GJH1211009R0222	K6-22Z-P-02	3/20
GJH1211009R0223	K6-22Z-P-03	3/20
GJH1211009R0311	K6-31Z-P-01	3/20
GJH1211009R0312	K6-31Z-P-02	3/20
GJH1211009R0313	K6-31Z-P-03	3/20
GJH1211009R0401	K6-40E-P-01	3/20
GJH1211009R0402	K6-40E-P-02	3/20
GJH1211009R0403	K6-40E-P-03	3/20
GJH1211009R8220	K6-22Z-P-80	3/20
GJH1211009R8224	K6-22Z-P-84	3/20
GJH1211009R8225	K6-22Z-P-85	3/20
GJH1211009R8310	K6-31Z-P-80	3/20
GJH1211009R8314	K6-31Z-P-84	3/20
GJH1211009R8315	K6-31Z-P-85	3/20
GJH1211009R8400	K6-40E-P-80	3/20
GJH1211009R8404	K6-40E-P-84	3/20
GJH1211009R8405	K6-40E-P-85	3/20
GJH1213001R0221	K6-22Z-01	3/13
GJH1213001R0224	K6-22Z-04	3/13
GJH1213001R0225	K6-22Z-05	3/13
GJH1213001R0227	K6-22Z-07	3/13
GJH1213001R0311	K6-31Z-01	3/13
GJH1213001R0314	K6-31Z-04	3/13
GJH1213001R0315	K6-31Z-05	3/13
GJH1213001R0317	K6-31Z-07	3/13
GJH1213001R0401	K6-40E-01	3/13
GJH1213001R0404	K6-40E-04	3/13
GJH1213001R0405	K6-40E-05	3/13
GJH1213001R0407	K6-40E-07	3/13
GJH1213001R1223	K6-22Z-13	3/13
GJH1213001R1226	K6-22Z-16	3/13
GJH1213001R1313	K6-31Z-13	3/13
GJH1213001R1316	K6-31Z-16	3/13
GJH1213001R1403	K6-40E-13	3/13
GJH1213001R1406	K6-40E-16	3/13
GJH1213001R5311	K6-31Z-2.4-51	3/14
GJH1213001R5401	K6-40E-2.4-51	3/14
GJH1213001R7221	K6S-22Z-1.7-71	3/14
GJH1213001R7222	K6S-22Z-2.8-72	3/14
GJH1213001R7311	K6S-31Z-1.7-71	3/14
GJH1213001R7312	K6S-31Z-2.8-72	3/14
GJH1213001R7401	K6S-40E-1.7-71	3/14
GJH1213001R7402	K6S-40E-2.8-72	3/14
GJH1213001R8311	K6-31Z-1.4-81	3/14
GJH1213001R8401	K6-40E-1.4-81	3/14
GJH1213009R0221	K6-22Z-P-01	3/21
GJH1213009R0224	K6-22Z-P-04	3/21
GJH1213009R0225	K6-22Z-P-05	3/21
GJH1213009R0227	K6-22Z-P-07	3/21
GJH1213009R0311	K6-31Z-P-01	3/21
GJH1213009R0314	K6-31Z-P-04	3/21
GJH1213009R0315	K6-31Z-P-05	3/21
GJH1213009R0401	K6-40E-P-01	3/21
GJH1213009R0404	K6-40E-P-04	3/21
GJH1213009R0405	K6-40E-P-05	3/21
GJH1213009R0407	K6-40E-P-07	3/21
GJH1213009R1226	K6-22Z-P-16	3/21
GJH1213009R1316	K6-31Z-P-16	3/21
GJH1213009R1406	K6-40E-P-16	3/21
GJH1213009R5311	K6-31Z-P-2.4-51	3/23
GJH1213009R5401	K6-40E-P-2.4-51	3/23
GJH1213009R8311	K6-31Z-P-1.4-81	3/23
GJH1213009R8401	K6-40E-P-1.4-81	3/23
GJH1213061R5221	TKC6-22Z-51	3/15
GJH1213061R5225	TKC6-22Z-55	3/15
GJH1213061R5311	TKC6-31Z-51	3/15
GJH1213061R5315	TKC6-31Z-55	3/15
GJH1213061R5401	TKC6-40E-51	3/15
GJH1213061R5405	TKC6-40E-55	3/15
GJH1213061R6222	TKC6-22Z-62	3/15
GJH1213061R6228	TKC6-22Z-68	3/15
GJH1213061R6312	TKC6-31Z-62	3/15
GJH1213061R6318	TKC6-31Z-68	3/15
GJH1213061R6402	TKC6-40E-62	3/15
GJH1213061R6408	TKC6-40E-68	3/15
GJL1201317R0001	CA6-11K	3/25
GJL1201317R0002	CA6-11E	3/24
GJL1201317R0003	CA6-11M	3/24
GJL1201317R0004	CA6-11N	3/24
GJL1201319R0001	CA6-11K-P	3/25
GJL1201319R0002	CA6-11E-P	3/24
GJL1201319R0003	CA6-11M-P	3/24
GJL1201319R0004	CA6-11N-P	3/24
GJL1201330R0001	CAF6-11K	3/25
GJL1201330R0002	CAF6-11E	3/24
GJL1201330R0003	CAF6-11M	3/24
GJL1201330R0004	CAF6-11N	3/24
GJL1201330R0005	CAF6-20K	3/25

Order code	Type	Page
GJL1201330R0006	CAF6-20E	3/24
GJL1201330R0007	CAF6-20M	3/24
GJL1201330R0008	CAF6-20N	3/24
GJL1201330R0009	CAF6-02K	3/25
GJL1201330R0010	CAF6-02E	3/24
GJL1201330R0011	CAF6-02M	3/24
GJL1201330R0012	CAF6-02N	3/24
GJL1201902R0001	LB6	3/25
GJL1201903R0001	LB6-CA	3/25
GJL1201906R0001	LT6-B	3/25
GJL1201907R0001	LP6	3/24
GJL1201908R0001	BSM6-30	3/24
GJL1211001R0011	B6-30-01-01	3/2
GJL1211001R0012	B6-30-01-02	3/2
GJL1211001R0013	B6-30-01-03	3/2
GJL1211001R0101	B6-30-10-01	3/2
GJL1211001R0102	B6-30-10-02	3/2
GJL1211001R0103	B6-30-10-03	3/2
GJL1211001R8010	B6-30-01-80	3/2
GJL1211001R8014	B6-30-01-84	3/2
GJL1211001R8015	B6-30-01-85	3/2
GJL1211001R8100	B6-30-10-80	3/2
GJL1211001R8104	B6-30-10-84	3/2
GJL1211001R8105	B6-30-10-85	3/2
GJL1211009R0011	B6-30-01-P-01	3/16
GJL1211009R0012	B6-30-01-P-02	3/16
GJL1211009R0013	B6-30-01-P-03	3/16
GJL1211009R0101	B6-30-10-P-01	3/16
GJL1211009R0102	B6-30-10-P-02	3/16
GJL1211009R0103	B6-30-10-P-03	3/16
GJL1211009R8010	B6-30-01-P-80	3/16
GJL1211009R8014	B6-30-01-P-84	3/16
GJL1211009R8015	B6-30-01-P-85	3/16
GJL1211009R8100	B6-30-10-P-80	3/16
GJL1211009R8104	B6-30-10-P-84	3/16
GJL1211009R8105	B6-30-10-P-85	3/16
GJL1211201R0001	B6-40-00-01	3/8
GJL1211201R0002	B6-40-00-02	3/8
GJL1211201R0003	B6-40-00-03	3/8
GJL1211201R8000	B6-40-00-80	3/8
GJL1211201R8004	B6-40-00-84	3/8
GJL1211501R0001	B6-22-00-01	3/8
GJL1211501R0002	B6-22-00-02	3/8
GJL1211501R0003	B6-22-00-03	3/8
GJL1211501R8000	B6-22-00-80	3/8
GJL1211501R8004	B6-22-00-84	3/8
GJL1211901R0011	VB6-30-01-01	3/4
GJL1211901R0012	VB6-30-01-02	3/4
GJL1211901R0013	VB6-30-01-03	3/4
GJL1211901R0101	VB6-30-10-01	3/4
GJL1211901R0102	VB6-30-10-02	3/4
GJL1211901R0103	VB6-30-10-03	3/4
GJL1211901R8010	VB6-30-01-80	3/4
GJL1211901R8014	VB6-30-01-84	3/4
GJL1211901R8015	VB6-30-01-85	3/4
GJL1211901R8100	VB6-30-10-80	3/4
GJL1211901R8104	VB6-30-10-84	3/4
GJL1211901R8105	VB6-30-10-85	3/4
GJL1211909R0011	VB6-30-01-P-01	3/18
GJL1211909R0012	VB6-30-01-P-02	3/18
GJL1211909R0013	VB6-30-01-P-03	3/18
GJL1211909R0101	VB6-30-10-P-01	3/18
GJL1211909R0102	VB6-30-10-P-02	3/18
GJL1211909R0103	VB6-30-10-P-03	3/18
GJL1211909R8010	VB6-30-01-P-80	3/18
GJL1211909R8014	VB6-30-01-P-84	3/18
GJL1211909R8015	VB6-30-01-P-85	3/18
GJL1211909R8100	VB6-30-10-P-80	3/18
GJL1211909R8104	VB6-30-10-P-84	3/18
GJL1211909R8105	VB6-30-10-P-85	3/18
GJL1213001R0011	BC6-30-01-01	3/3
GJL1213001R0013	BC6-30-01-03	3/3
GJL1213001R0014	BC6-30-01-04	3/3
GJL1213001R0015	BC6-30-01-05	3/3
GJL1213001R0017	BC6-30-01-07	3/3
GJL1213001R0101	BC6-30-10-01	3/3
GJL1213001R0103	BC6-30-10-03	3/3
GJL1213001R0104	BC6-30-10-04	3/3
GJL1213001R0105	BC6-30-10-05	3/3
GJL1213001R1017	BC6-30-10-07	3/3
GJL1213001R1016	BC6-30-01-16	3/3
GJL1213001R1106	BC6-30-10-16	3/3
GJL1213001R5011	BC6-30-01-2.4-51	3/6
GJL1213001R5101	BC6-30-10-2.4-51	3/6
GJL1213001R7011	B6S-30-01-1.7-71	3/6
GJL1213001R7012	B6S-30-01-2.8-72	3/6
GJL1213001R7101	B6S-30-01-1.7-71	3/6
GJL1213001R7102	B6S-30-01-2.8-72	3/6
GJL1213001R8011	BC6-30-01-1.4-81	3/6
GJL1213001R8101	BC6-30-10-1.4-81	3/6
GJL1213009R0011	BC6-30-01-P-01	3/17
GJL1213009R0013	BC6-30-01-P-03	3/17
GJL1213009R0014	BC6-30-01-P-04	3/17
GJL1213009R0015	BC6-30-01-P-05	3/17
GJL1213009R0017	BC6-30-01-P-07	3/17
GJL1213009R0101	BC6-30-10-P-01	3/17
GJL1213009R0103	BC6-30-10-P-03	3/17
GJL1213009R0104	BC6-30-10-P-04	3/17
GJL1213009R0105	BC6-30-10-P-05	3/17
GJL1213009R0107	BC6-30-10-P-07	3/17

Order code	Type	Page
GJL1213009R1016	BC6-30-01-P-16	3/17
GJL1213009R1106	BC6-30-10-P-16	3/17
GJL1213009R5011	BC6-30-01-P-2.4-51	3/22
GJL1213009R5101	BC6-30-10-P-2.4-51	3/22
GJL1213009R8011	BC6-30-01-P-1.4-81	3/22
GJL1213009R8101	BC6-30-10-P-1.4-81	3/22
GJL1213109R0101	BC6-21-10-P-01	3/17
GJL1213109R0103	BC6-21-10-P-03	3/17
GJL1213109R0104	BC6-21-10-P-04	3/17
GJL1213109R0105	BC6-21-10-P-05	3/17
GJL1213109R1106	BC6-21-10-P-16	3/17
GJL1213501R0001	BC6-22-00-01	3/9
GJL1213501R0002	BC6-22-00-02	3/9
GJL1213501R0003	BC6-22-00-03	3/9
GJL1213501R0004	BC6-22-00-04	3/9
GJL1213501R0005	BC6-22-00-05	3/9
GJL1213501R0007	BC6-22-00-07	3/9
GJL1213501R1006	BC6-22-00-16	3/9
GJL1213901R0011	VBC6-30-01-01	3/5
GJL1213901R0013	VBC6-30-01-03	3/5
GJL1213901R0014	VBC6-30-01-04	3/5
GJL1213901R0015	VBC6-30-01-05	3/5
GJL1213901R0017	VBC6-30-01-07	3/5
GJL1213901R0101	VBC6-30-10-01	3/5
GJL1213901R0103	VBC6-30-10-03	3/5
GJL1213901R0104	VBC6-30-10-04	3/5
GJL1213901R0105	VBC6-30-10-05	3/5
GJL1213901R0107	VBC6-30-10-07	3/5
GJL1213901R1016	VBC6-30-01-16	3/5
GJL1213901R1106	VBC6-30-10-16	3/5
GJL1213909R0011	VBC6-30-01-P-01	3/19
GJL1213909R0013	VBC6-30-01-P-03	3/19
GJL1213909R0014	VBC6-30-01-P-04	3/19
GJL1213909R0015	VBC6-30-01-P-05	3/19
GJL1213909R0016	VBC6-30-06-P-06	3/19
GJL1213909R0017	VBC6-30-01-P-07	3/19
GJL1213909R0101	VBC6-30-10-P-01	3/19
GJL1213909R0103	VBC6-30-10-P-03	3/19
GJL1213909R0104	VBC6-30-10-P-04	3/19
GJL1213909R0105	VBC6-30-10-P-05	3/19
GJL1213909R0106	VBC6-30-10-P-06	3/19
GJL1213909R0107	VBC6-30-10-P-07	3/19
GJL1311001R0011	B7-30-01-01	3/2
GJL1311001R0012	B7-30-01-02	3/2
GJL1311001R0013	B7-30-01-03	3/2
GJL1311001R0101	B7-30-10-01	3/2
GJL1311001R0102	B7-30-10-02	3/2
GJL1311001R0103	B7-30-10-03	3/2
GJL1311001R8101	B7-30-01-81	3/2
GJL1311001R8104	B7-30-01-84	3/2
GJL1311001R8105	B7-30-01-85	3/2
GJL1311009R0011	B7-30-01-P-01	3/16
GJL131		

Index

Order code classification

Order code	Type	Page	Order code	Type	Page	Order code	Type	Page
GJL1313001R0011	BC7-30-01-01	3/3	SK824440-DG	EK110-40-21	5/69	SK826450-EP	KP300	5/156
GJL1313001R0013	BC7-30-01-03	3/3	SK824440-DT	EK110-40-21	5/69	SK826450-FR	KP300	5/156
GJL1313001R0014	BC7-30-01-04	3/3	SK824440-DU	EK110-40-21	5/69	SK827040-AD	EK370-40-11	5/70
GJL1313001R0015	BC7-30-01-05	3/3	SK824441-AD	EK150-40-11	5/68	SK827040-AR	EK370-40-11	5/70
GJL1313001R0017	BC7-30-01-07	3/3	SK824441-AE	EK150-40-11	5/68	SK827040-DB	EK370-40-21	5/71
GJL1313001R0101	BC7-30-10-01	3/3	SK824441-AF	EK150-40-11	5/68	SK827040-DC	EK370-40-21	5/71
GJL1313001R0104	BC7-30-10-04	3/3	SK824441-AL	EK150-40-11	5/68	SK827040-DD	EK370-40-21	5/71
GJL1313001R0105	BC7-30-10-05	3/3	SK824441-AM	EK150-40-11	5/68	SK827040-DE	EK370-40-21	5/71
GJL1313001R0107	BC7-30-10-07	3/3	SK824441-AN	EK150-40-11	5/68	SK827040-DF	EK370-40-21	5/71
GJL1313001R1016	BC7-30-01-16	3/3	SK824441-AP	EK150-40-11	5/68	SK827040-DG	EK370-40-21	5/71
GJL1313001R1103	BC7-30-10-03	3/3	SK824441-AR	EK150-40-11	5/68	SK827040-DT	EK370-40-21	5/71
GJL1313001R1106	BC7-30-10-16	3/3	SK824441-DA	EK150-40-21	5/69	SK827040-DU	EK370-40-21	5/71
GJL1313001R5011	BC7-30-01-2.4-51	3/6	SK824441-DB	EK150-40-21	5/69	SK827040-EF	EK370-40-11	5/70
GJL1313001R5101	BC7-30-10-2.4-51	3/6	SK824441-DC	EK150-40-21	5/69	SK827040-EG	EK370-40-11	5/70
GJL1313001R7011	B7S-30-01-1.7-71	3/6	SK824441-DD	EK150-40-21	5/69	SK827040-EL	EK370-40-11	5/70
GJL1313001R7012	B7S-30-01-2.8-72	3/6	SK824441-DE	EK150-40-21	5/69	SK827040-EM	EK370-40-11	5/70
GJL1313001R7101	B7S-30-10-1.7-71	3/6	SK824441-DF	EK150-40-21	5/69	SK827040-EP	EK370-40-11	5/70
GJL1313001R7102	B7S-30-10-2.8-72	3/6	SK824441-DG	EK150-40-21	5/69	SK827040-ER	EK370-40-11	5/70
GJL1313001R8011	BC7-30-01-1.4-81	3/6	SK824441-DT	EK150-40-21	5/69	SK827041-AD	EK550-40-11	5/70
GJL1313001R8101	BC7-30-10-1.4-81	3/6	SK824441-DU	EK150-40-21	5/69	SK827041-AR	EK550-40-11	5/70
GJL1313009R0011	BC7-30-01-P-01	3/17	SK825204-A	KZK175	5/154	SK827041-DB	EK550-40-21	5/71
GJL1313009R0013	BC7-30-01-P-03	3/17	SK825204-B	KZK210	5/154	SK827041-DC	EK550-40-21	5/71
GJL1313009R0014	BC7-30-01-P-04	3/17	SK825400-AD	KH210	5/155	SK827041-DD	EK550-40-21	5/71
GJL1313009R0015	BC7-30-01-P-05	3/17	SK825400-AE	KH210	5/155	SK827041-DE	EK550-40-21	5/71
GJL1313009R0017	BC7-30-01-P-07	3/17	SK825400-AF	KH210	5/155	SK827041-DF	EK550-40-21	5/71
GJL1313009R0101	BC7-30-10-P-01	3/17	SK825400-AL	KH210	5/155	SK827041-DG	EK550-40-21	5/71
GJL1313009R0103	BC7-30-10-P-03	3/17	SK825400-AM	KH210	5/155	SK827041-DT	EK550-40-21	5/71
GJL1313009R0104	BC7-30-10-P-04	3/17	SK825400-AN	KH210	5/155	SK827041-DU	EK550-40-21	5/71
GJL1313009R0105	BC7-30-10-P-05	3/17	SK825400-AP	KH210	5/155	SK827041-EF	EK550-40-11	5/70
GJL1313009R0107	BC7-30-10-P-07	3/17	SK825400-AR	KH210	5/155	SK827041-EG	EK550-40-11	5/70
GJL1313009R1016	BC7-30-01-P-16	3/17	SK825440-AD	EK175-40-11	5/70	SK827041-EL	EK550-40-11	5/70
GJL1313009R1106	BC7-30-10-P-16	3/17	SK825440-AE	EK175-40-11	5/70	SK827041-EM	EK550-40-11	5/70
GJL1313009R5011	BC7-30-01-P-2.4-51	3/22	SK825440-AF	EK175-40-11	5/70	SK827041-EP	EK550-40-11	5/70
GJL1313009R5101	BC7-30-10-P-2.4-51	3/22	SK825440-AL	EK175-40-11	5/70	SK827041-ER	EK550-40-11	5/70
GJL1313009R8011	BC7-30-01-P-1.4-81	3/22	SK825440-AM	EK175-40-11	5/70	SK827044-AD	EK1000-40-11	5/72
GJL1313009R8101	BC7-30-10-P-1.4-81	3/22	SK825440-AN	EK175-40-11	5/70	SK827044-AR	EK1000-40-11	5/72
GJL1313061R5011	TBC7-30-01-51	3/7	SK825440-AP	EK175-40-11	5/70	SK827044-DB	EK1000-40-21	5/73
GJL1313061R5015	TBC7-30-01-55	3/7	SK825440-AR	EK175-40-11	5/70	SK827044-DC	EK1000-40-21	5/73
GJL1313061R5101	TBC7-30-10-51	3/7	SK825440-DA	EK175-40-21	5/71	SK827044-DD	EK1000-40-21	5/73
GJL1313061R5105	TBC7-30-10-55	3/7	SK825440-DB	EK175-40-21	5/71	SK827044-DE	EK1000-40-21	5/73
GJL1313061R6012	TBC7-30-01-62	3/7	SK825440-DC	EK175-40-21	5/71	SK827044-DF	EK1000-40-21	5/73
GJL1313061R6018	TBC7-30-01-68	3/7	SK825440-DD	EK175-40-21	5/71	SK827044-DG	EK1000-40-21	5/73
GJL1313061R6102	TBC7-30-10-62	3/7	SK825440-DE	EK175-40-21	5/71	SK827044-DT	EK1000-40-21	5/73
GJL1313061R6108	TBC7-30-10-68	3/7	SK825440-DF	EK175-40-21	5/71	SK827044-DU	EK1000-40-21	5/73
GJL1313461R5005	TBC7-31-00-55	3/10	SK825440-DG	EK175-40-21	5/71	SK827044-EF	EK1000-40-11	5/72
GJL1313461R6002	TBC7-31-00-62	3/10	SK825440-DT	EK175-40-21	5/71	SK827044-EG	EK1000-40-11	5/72
GJL1313461R6008	TBC7-31-00-68	3/10	SK825440-DU	EK175-40-21	5/71	SK827044-EL	EK1000-40-11	5/72
GJL1313561R5005	TBC7-22-00-55	3/10	SK825441-AD	EK210-40-11	5/70	SK827044-EM	EK1000-40-11	5/72
GJL1313561R6002	TBC7-22-00-62	3/10	SK825441-AE	EK210-40-11	5/70	SK827044-EP	EK1000-40-11	5/72
GJL1313561R6008	TBC7-22-00-68	3/10	SK825441-AF	EK210-40-11	5/70	SK827044-ER	EK1000-40-11	5/72
GJL1313901R0011	VBC7-30-01-01	3/5	SK825441-AL	EK210-40-11	5/70	SK827204-A	KZK370	5/154
GJL1313901R0013	VBC7-30-01-03	3/5	SK825441-AM	EK210-40-11	5/70	SK827204-B	KZK550	5/154
GJL1313901R0014	VBC7-30-01-04	3/5	SK825441-AN	EK210-40-11	5/70	SK827204-F	KZK1000	5/154
GJL1313901R0015	VBC7-30-01-05	3/5	SK825441-AP	EK210-40-11	5/70	SK828100-AD	KH800	5/155
GJL1313901R0017	VBC7-30-01-07	3/5	SK825441-AR	EK210-40-11	5/70	SK828100-AR	KH800	5/155
GJL1313901R0101	VBC7-30-10-01	3/5	SK825441-DA	EK210-40-21	5/71	SK828100-EF	KH800	5/155
GJL1313901R0103	VBC7-30-10-03	3/5	SK825441-DB	EK210-40-21	5/71	SK828100-EG	KH800	5/155
GJL1313901R0104	VBC7-30-10-04	3/5	SK825441-DC	EK210-40-21	5/71	SK828100-EL	KH800	5/155
GJL1313901R0105	VBC7-30-10-05	3/5	SK825441-DD	EK210-40-21	5/71	SK828100-EM	KH800	5/155
GJL1313901R0107	VBC7-30-10-07	3/5	SK825441-DE	EK210-40-21	5/71	SK828100-EP	KH800	5/155
GJL1313901R0106	VBC7-30-01-16	3/5	SK825441-DF	EK210-40-21	5/71	SK828100-ER	KH800	5/155
GJL1313901R1106	VBC7-30-10-16	3/5	SK825441-DG	EK210-40-21	5/71	SK828150-DB	KP800	5/156
GJL1313909R0011	VBC7-30-01-P-01	3/19	SK825441-DT	EK210-40-21	5/71	SK828150-DC	KP800	5/156
GJL1313909R0013	VBC7-30-01-P-03	3/19	SK825441-DU	EK210-40-21	5/71	SK828150-DD	KP800	5/156
GJL1313909R0014	VBC7-30-01-P-04	3/19	SK825450-DA	KP210	5/156	SK828150-DE	KP800	5/156
GJL1313909R0015	VBC7-30-01-P-05	3/19	SK825450-DB	KP210	5/156	SK828150-DF	KP800	5/156
GJL1313909R0017	VBC7-30-01-P-07	3/19	SK825450-DC	KP210	5/156	SK828150-DG	KP800	5/156
GJL1313909R0101	VBC7-30-10-P-01	3/19	SK825450-DD	KP210	5/156	SK828150-DT	KP800	5/156
GJL1313909R0103	VBC7-30-10-P-03	3/19	SK825450-DE	KP210	5/156	SK828150-DU	KP800	5/156
GJL1313909R0104	VBC7-30-10-P-04	3/19	SK825450-DF	KP210	5/156	SK829002-A	CAL16-11A	5/148
GJL1313909R0105	VBC7-30-10-P-05	3/19	SK825450-DG	KP210	5/156	SK829002-B	CAL16-11B	5/148
GJL1313909R0107	VBC7-30-10-P-07	3/19	SK825450-DT	KP210	5/156	SK829002-C	CAL16-11C	5/148
GJL1313909R1016	VBC7-30-01-P-16	3/19	SK825450-DU	KP210	5/156	SK829002-D	CAL16-11D	5/148
GJL1313909R1106	VBC7-30-10-P-16	3/19	SK825450-EF	KP210	5/156	SK829002-E	CCL16-11E	5/148
GJL1317001R0011	B7D-30-01-01	3/3	SK825450-EG	KP210	5/156	SK829007-A	RC-EH300/48	5/150
GJL1317001R0015	B7D-30-01-05	3/3	SK825450-EL	KP210	5/156	SK829007-B	RC-EH300/415	5/150
GJL1317001R0101	B7D-30-10-01	3/3	SK825450-EM	KP210	5/156	SK829007-C	RC-EH800/110	5/150
GJL1317001R0105	B7D-30-10-05	3/3	SK825450-EP	KP210	5/156	SK829007-D	RC-EH800/600	5/150
GJL1317201R0001	B7D-40-00-01	3/9	SK825450-ER	KP210	5/156	SK829070-F	VH800	5/153
GJL1317201R0005	B7D-40-00-05	3/9	SK826400-AD	KH300	5/155	SK829071-A	VH145	5/153
SK178001-HB	LT150-EK	5/149	SK826400-AE	KH300	5/155	SK829071-B	VH300	5/153
SK178001-KB	LT210-EK	5/149	SK826400-AF	KH300	5/155	SK829075-C	PN210-22	5/151
SK178001-LB	LT550-EK	5/149	SK826400-AL	KH300	5/155	SK829075-E	PN300-22	5/151
SK178001-MB	LT1000-EK	5/149	SK826400-AM	KH300	5/155	SK829090-B	BSS100	5/152
SK824204-A	KZK110	5/154	SK826400-AN	KH300	5/155	SK829090-E	BSS550	5/152
SK824204-B	KZK150	5/154	SK826400-AP	KH300	5/155	SK829090-F	BSS145	5/152
SK824440-AD	EK110-40-11	5/68	SK826400-AR	KH300	5/155	SK829090-G	BSS210	5/152
SK824440-AE	EK110-40-11	5/68	SK826450-DA	KP300	5/156	SK829090-H	BSS1000	5/152
SK824440-AF	EK110-40-11	5/68	SK826450-DB	KP300	5/156			
SK824440-AL	EK110-40-11	5/68	SK826450-DC	KP300	5/156			
SK824440-AM	EK110-40-11	5/68	SK826450-DD	KP300	5/156			
SK824440-AN	EK110-40-11	5/68	SK826450-DE	KP300	5/156			
SK824440-AP	EK110-40-11	5/68	SK826450-DF	KP300	5/156			
SK824440-AR	EK110-40-11	5/68	SK826450-DG	KP300	5/156			
SK824440-DA	EK110-40-21	5/69	SK826450-DT	KP300	5/156			
SK824440-DB	EK110-40-21	5/69	SK826450-DU	KP300	5/156			
SK824440-DC	EK110-40-21	5/69	SK826450-EF	KP300	5/156			
SK824440-DD	EK110-40-21	5/69	SK826450-EG	KP300	5/156			
SK824440-DE	EK110-40-21	5/69	SK826450-EL	KP300	5/156			
SK824440-DF	EK110-40-21	5/69	SK826450-EM	KP300	5/156			

Index

Type classification

Type	Order code	Page
A110-30-00	1SFL451001R8000	5/18
A145-30-11	1SFL471001R8011	5/22
A185-30-11	1SFL491001R8011	5/22
A210-30-11	1SFL511001R8011	5/22
A260-30-11	1SFL531001R8011	5/22
A300-30-11	1SFL551001R8011	5/22
A40-30-01	1SBL321001R8001	5/10
A40-30-10	1SBL321001R8010	5/10
A45-22-00	1SBL331501R8000	5/63
A45-40-00	1SBL331201R8000	5/63
A50-30-00	1SBL351001R8000	5/11
A50-40-00	1SBL351201R8000	5/63
A63-30-00	1SBL371001R8000	5/11
A75-22-00	1SBL411501R8000	5/63
A75-30-00	1SBL411001R8000	5/11
A75-40-00	1SBL411201R8000	5/63
A95-30-00	1SFL431001R8000	5/18
AA1-110	1SAM201910R1002	2/7
AA1-230	1SAM201910R1003	2/7
AA1-24	1SAM201910R1001	2/7
AA1-400	1SAM201910R1004	2/7
AA-230	1SAM101909R0002	2/45
AA-24	1SAM101909R0001	2/45
AA-400	1SAM101909R0003	2/45
AA4-110	1SAM401907R1002	2/28
AA4-230	1SAM401907R1003	2/28
AA4-24	1SAM401907R1001	2/28
AA4-400	1SAM401907R1004	2/28
AE45-22-00	1SBL339501R8100	5/64
AE45-40-00	1SBL339201R8100	5/64
AE50-30-00	1SBL359001R8100	5/13
AE50-40-00	1SBL359201R8100	5/64
AE63-30-00	1SBL379001R8100	5/13
AE75-22-00	1SBL419501R8100	5/64
AE75-30-00	1SBL419001R8100	5/13
AE75-40-00	1SBL419201R8100	5/64
AF09-22-00-11	1SBL137501R1100	5/58
AF09-22-00-12	1SBL137501R1200	5/58
AF09-22-00-13	1SBL137501R1300	5/58
AF09-22-00-14	1SBL137501R1400	5/58
AF09-30-01-11	1SBL137001R1101	5/6
AF09-30-01-12	1SBL137001R1201	5/6
AF09-30-01-13	1SBL137001R1301	5/6
AF09-30-01-14	1SBL137001R1401	5/6
AF09-30-10-11	1SBL137001R1110	5/6
AF09-30-10-12	1SBL137001R1210	5/6
AF09-30-10-13	1SBL137001R1310	5/6
AF09-30-10-14	1SBL137001R1410	5/6
AF09-40-00-11	1SBL137201R1100	5/58
AF09-40-00-12	1SBL137201R1200	5/58
AF09-40-00-13	1SBL137201R1300	5/58
AF09-40-00-14	1SBL137201R1400	5/58
AF09Z-22-00-20	1SBL136501R2000	5/59
AF09Z-22-00-21	1SBL136501R2100	5/59
AF09Z-22-00-22	1SBL136501R2200	5/59
AF09Z-22-00-23	1SBL136501R2300	5/59
AF09Z-30-01-20	1SBL136001R2001	5/7
AF09Z-30-01-21	1SBL136001R2101	5/7
AF09Z-30-01-22	1SBL136001R2201	5/7
AF09Z-30-01-23	1SBL136001R2301	5/7
AF09Z-30-10-20	1SBL136001R2010	5/7
AF09Z-30-10-21	1SBL136001R2110	5/7
AF09Z-30-10-22	1SBL136001R2210	5/7
AF09Z-30-10-23	1SBL136001R2310	5/7
AF09Z-40-00-20	1SBL136201R2000	5/59
AF09Z-40-00-21	1SBL136201R2100	5/59
AF09Z-40-00-22	1SBL136201R2200	5/59
AF09Z-40-00-23	1SBL136201R2300	5/59
AF110-30-00	1SFL457001R6900	5/19
AF12-30-01-11	1SBL157001R1101	5/6
AF12-30-01-12	1SBL157001R1201	5/6
AF12-30-01-13	1SBL157001R1301	5/6
AF12-30-01-14	1SBL157001R1401	5/6
AF12-30-10-11	1SBL157001R1110	5/6
AF12-30-10-12	1SBL157001R1210	5/6
AF12-30-10-13	1SBL157001R1310	5/6
AF12-30-10-14	1SBL157001R1410	5/6
AF1250-30-11	1SFL647001R6911	5/25
AF12Z-30-01-20	1SBL156001R2001	5/7
AF12Z-30-01-21	1SBL156001R2101	5/7
AF12Z-30-01-22	1SBL156001R2201	5/7
AF12Z-30-01-23	1SBL156001R2301	5/7
AF12Z-30-10-20	1SBL156001R2010	5/7
AF12Z-30-10-21	1SBL156001R2110	5/7
AF12Z-30-10-22	1SBL156001R2210	5/7
AF12Z-30-10-23	1SBL156001R2310	5/7
AF1350-30-11	1SFL657001R7011	5/25
AF145-30-11	1SFL477001R6911	5/23
AF16-22-00-11	1SBL177501R1100	5/58
AF16-22-00-12	1SBL177501R1200	5/58
AF16-22-00-13	1SBL177501R1300	5/58
AF16-22-00-14	1SBL177501R1400	5/58
AF16-30-01-11	1SBL177001R1101	5/6
AF16-30-01-12	1SBL177001R1201	5/6
AF16-30-01-13	1SBL177001R1301	5/6
AF16-30-01-14	1SBL177001R1401	5/6
AF16-30-10-11	1SBL177001R1110	5/6
AF16-30-10-12	1SBL177001R1210	5/6
AF16-30-10-13	1SBL177001R1310	5/6
AF16-30-10-14	1SBL177001R1410	5/6

Type	Order code	Page
AF16-40-00-11	1SBL177201R1100	5/58
AF16-40-00-12	1SBL177201R1200	5/58
AF16-40-00-13	1SBL177201R1300	5/58
AF16-40-00-14	1SBL177201R1400	5/58
AF1650-30-11	1SFL677001R7011	5/25
AF16Z-22-00-20	1SBL176501R2000	5/59
AF16Z-22-00-21	1SBL176501R2100	5/59
AF16Z-22-00-22	1SBL176501R2200	5/59
AF16Z-22-00-23	1SBL176501R2300	5/59
AF16Z-30-01-20	1SBL176001R2001	5/7
AF16Z-30-01-21	1SBL176001R2101	5/7
AF16Z-30-01-22	1SBL176001R2201	5/7
AF16Z-30-01-23	1SBL176001R2301	5/7
AF16Z-30-10-20	1SBL176001R2100	5/7
AF16Z-30-10-21	1SBL176001R2110	5/7
AF16Z-30-10-22	1SBL176001R2210	5/7
AF16Z-30-10-23	1SBL176001R2310	5/7
AF16Z-40-00-20	1SBL176201R2000	5/59
AF16Z-40-00-21	1SBL176201R2100	5/59
AF16Z-40-00-22	1SBL176201R2200	5/59
AF16Z-40-00-23	1SBL176201R2300	5/59
AF185-30-11	1SFL497001R6911	5/23
AF2050-30-11	1SFL707001R7011	5/25
AF210-30-11	1SFL517001R6911	5/23
AF260-30-11	1SFL537001R6911	5/23
AF26-22-00-11	1SBL237501R1100	5/58
AF26-22-00-12	1SBL237501R1200	5/58
AF26-22-00-13	1SBL237501R1300	5/58
AF26-22-00-14	1SBL237501R1400	5/58
AF26-30-00-11	1SBL237001R1100	5/6
AF26-30-00-12	1SBL237001R1200	5/6
AF26-30-00-13	1SBL237001R1300	5/6
AF26-30-00-14	1SBL237001R1400	5/6
AF26-40-00-11	1SBL237201R1100	5/58
AF26-40-00-12	1SBL237201R1200	5/58
AF26-40-00-13	1SBL237201R1300	5/58
AF26-40-00-14	1SBL237201R1400	5/58
AF26Z-22-00-20	1SBL236501R2000	5/59
AF26Z-22-00-21	1SBL236501R2100	5/59
AF26Z-22-00-22	1SBL236501R2200	5/59
AF26Z-22-00-23	1SBL236501R2300	5/59
AF26Z-30-00-20	1SBL236001R2000	5/7
AF26Z-30-00-21	1SBL236001R2100	5/7
AF26Z-30-00-22	1SBL236001R2200	5/7
AF26Z-30-00-23	1SBL236001R2300	5/7
AF26Z-40-00-20	1SBL236201R2000	5/59
AF26Z-40-00-21	1SBL236201R2100	5/59
AF26Z-40-00-22	1SBL236201R2200	5/59
AF26Z-40-00-23	1SBL236201R2300	5/59
AF300-30-11	1SFL557001R6911	5/23
AF30-30-00-11	1SBL277001R1100	5/6
AF30-30-00-12	1SBL277001R1200	5/6
AF30-30-00-13	1SBL277001R1300	5/6
AF30-30-00-14	1SBL277001R1400	5/6
AF30Z-30-00-20	1SBL276001R2000	5/7
AF30Z-30-00-21	1SBL276001R2100	5/7
AF30Z-30-00-22	1SBL276001R2200	5/7
AF30Z-30-00-23	1SBL276001R2300	5/7
AF38-22-00-11	1SBL297501R1100	5/58
AF38-22-00-12	1SBL297501R1200	5/58
AF38-22-00-13	1SBL297501R1300	5/58
AF38-22-00-14	1SBL297501R1400	5/58
AF38-30-00-11	1SBL297001R1100	5/6
AF38-30-00-12	1SBL297001R1200	5/6
AF38-30-00-13	1SBL297001R1300	5/6
AF38-30-00-14	1SBL297001R1400	5/6
AF38-40-00-11	1SBL297201R1100	5/58
AF38-40-00-12	1SBL297201R1200	5/58
AF38-40-00-13	1SBL297201R1300	5/58
AF38-40-00-14	1SBL297201R1400	5/58
AF38Z-22-00-20	1SBL296501R2000	5/59
AF38Z-22-00-21	1SBL296501R2100	5/59
AF38Z-22-00-22	1SBL296501R2200	5/59
AF38Z-22-00-23	1SBL296501R2300	5/59
AF38Z-30-00-20	1SBL296001R2000	5/7
AF38Z-30-00-21	1SBL296001R2100	5/7
AF38Z-30-00-22	1SBL296001R2200	5/7
AF38Z-30-00-23	1SBL296001R2300	5/7
AF38Z-40-00-20	1SBL296201R2000	5/59
AF38Z-40-00-21	1SBL296201R2100	5/59
AF38Z-40-00-22	1SBL296201R2200	5/59
AF38Z-40-00-23	1SBL296201R2300	5/59
AF400-30-11	1SFL577001R6911	5/24
AF45-22-00	1SBL337501R6900	5/65
AF45-40-00	1SBL337201R6900	5/65
AF460-30-11	1SFL597001R6911	5/24
AF50-30-00	1SBL357001R6900	5/14
AF50-40-00	1SBL357201R6900	5/65
AF580-30-11	1SFL617001R6911	5/24
AF63-30-00	1SBL377001R6900	5/14
AF750-30-11	1SFL637001R6911	5/24
AF75-22-00	1SBL417501R6900	5/65
AF75-30-00	1SBL417001R6900	5/14
AF75-40-00	1SBL417201R6900	5/65
AF95-30-00	1SFL437001R6900	5/19
AL40-30-01	1SBL323001R8101	5/12
AL40-30-10	1SBL323001R8110	5/12
AS09-30-01-16	1SBL101001R1601	4/4
AS09-30-01-20	1SBL101001R2001	4/4
AS09-30-01-26	1SBL101001R2601	4/4

Type	Order code	Page
AS09-30-01-28	1SBL101001R2801	4/4
AS09-30-10-16	1SBL101001R1610	4/4
AS09-30-10-20	1SBL101001R2010	4/4
AS09-30-10-26	1SBL101001R2610	4/4
AS09-30-10-28	1SBL101001R2810	4/4
AS09-30-32-16	1SBL101001R1632	4/6
AS09-30-32-20	1SBL101001R2032	4/6
AS09-30-32-26	1SBL101001R2632	4/6
AS09-30-32-28	1SBL101001R2832	4/6
AS12-30-01-16	1SBL111001R1601	4/4
AS12-30-01-20	1SBL111001R2001	4/4
AS12-30-01-26	1SBL111001R2601	4/4
AS12-30-01-28	1SBL111001R2801	4/4
AS12-30-10-16	1SBL111001R1610	4/4
AS12-30-10-20	1SBL111001R2010	4/4
AS12-30-10-26	1SBL111001R2610	4/4
AS12-30-10-28	1SBL111001R2810	4/4
AS12-30-32-16	1SBL111001R1632	4/6
AS12-30-32-20	1SBL111001R2032	4/6
AS12-30-32-26	1SBL111001R2632	4/6
AS12-30-32-28	1SBL111001R2832	4/6
AS16-30-01-16	1SBL121001R1601	4/4
AS16-30-01-20	1SBL121001R2001	4/4
AS16-30-01-26	1SBL121001R2601	4/4
AS16-30-01-28	1SBL121001R2801	4/4
AS16-30-10-16	1SBL121001R1610	4/4
AS16-30-10-20	1SBL121001R2010	4/4
AS16-30-10-26	1SBL121001R2610	4/4
AS16-30-10-28	1SBL121001R2810	4/4
AS16-30-32-16	1SBL121001R1632	4/6
AS16-30-32-20	1SBL121001R2032	4/6
AS16-30-32-26	1SBL121001R2632	4/6
AS16-30-32-28	1SBL121001R2832	4/6
ASL09-30-01-81	1SBL103001R8101	4/5
ASL09-30-01-83	1SBL103001R8301	4/5
ASL09-30-01-86	1SBL103001R8601	4/5
ASL09-30-01-88	1SBL103001R8801	4/5
ASL09-30-10-81	1SBL103001R8110	4/5
ASL09-30-10-83	1SBL103001R8310	4/5
ASL09-30-10-86	1SBL103001R8610	4/5
ASL09-30-10-88	1SBL103001R8810	4/5
ASL09-30-32-81	1SBL103001R8132	4/7
ASL09-30-32-83	1SBL103001R8332	4/7
ASL09-30-32-86	1SBL103001R8632	4/7
ASL09-30-32-88	1SBL103001R8832	4/7
ASL12-30-01-81	1SBL113001R8101	4/5
ASL12-30-01-83	1SBL113001R8301	4/5
ASL12-30-01-8		

Index

Type classification

Type	Order code	Page	Type	Order code	Page	Type	Order code	Page
B6-40-00-03	GJL1211201R0003	3/8	BC7-30-01-03	GJL1313001R0013	3/3	B5M6-30	GJL1201908R0001	3/24
B6-40-00-80	GJL1211201R8000	3/8	BC7-30-01-04	GJL1313001R0014	3/3	BSS100	SK829090-B	5/152
B6-40-00-84	GJL1211201R8004	3/8	BC7-30-01-05	GJL1313001R0015	3/3	BSS1000	SK829090-H	5/152
B6S-30-01-1.7-71	GJL1213001R7011	3/6	BC7-30-01-07	GJL1313001R0017	3/3	BSS145	SK829090-F	5/152
B6S-30-01-2.8-72	GJL1213001R7012	3/6	BC7-30-01-1.4-81	GJL1313001R8011	3/6	BSS210	SK829090-G	5/152
B6S-30-10-1.7-71	GJL1213001R7011	3/6	BC7-30-01-16	GJL1313001R1016	3/3	BSS550	SK829090-E	5/152
B6S-30-10-2.8-72	GJL1213001R7102	3/6	BC7-30-01-2.4-51	GJL1313001R5011	3/6	BX4	15BN110108T1000	5/120
B7-22-00-01	GJL1311501R0001	3/8	BC7-30-01-P-01	GJL1313009R0011	3/17	BX4-CA	15BN110109W1000	5/120
B7-22-00-02	GJL1311501R0002	3/8	BC7-30-01-P-03	GJL1313009R0013	3/17	BX-TP	FP47N472657R0001	5/123
B7-22-00-03	GJL1311501R0003	3/8	BC7-30-01-P-04	GJL1313009R0014	3/17	CA3-01	15BN011010T1001	4/9
B7-22-00-80	GJL1311501R8000	3/8	BC7-30-01-P-05	GJL1313009R0015	3/17	CA3-10	15BN011010T1010	4/9
B7-22-00-84	GJL1311501R8004	3/8	BC7-30-01-P-07	GJL1313009R0017	3/17	CA4-01	15BN010110R1001	5/116
B7-30-01-01	GJL1311001R0011	3/2	BC7-30-01-P-1.4-81	GJL1313009R8011	3/22	CA4-01-T	15BN010110T1001	5/116
B7-30-01-02	GJL1311001R0012	3/2	BC7-30-01-P-16	GJL1313009R1016	3/17	CA4-04E	15BN010140R1004	5/116
B7-30-01-03	GJL1311001R0013	3/2	BC7-30-01-P-2.4-51	GJL1313009R5011	3/22	CA4-04M	15BN010140R1104	5/116
B7-30-01-80	GJL1311001R8010	3/2	BC7-30-10-01	GJL1313001R0101	3/3	CA4-04N	15BN010140R1204	5/116
B7-30-01-84	GJL1311001R8014	3/2	BC7-30-10-03	GJL1313001R1103	3/3	CA4-10	15BN010110R1010	5/116
B7-30-01-85	GJL1311001R8015	3/2	BC7-30-10-04	GJL1313001R0104	3/3	CA4-10-T	15BN010110T1010	5/116
B7-30-01-P-01	GJL1311009R0011	3/16	BC7-30-10-05	GJL1313001R0105	3/3	CA4-13M	15BN010110R1113	5/116
B7-30-01-P-02	GJL1311009R0012	3/16	BC7-30-10-07	GJL1313001R0107	3/3	CA4-13N	15BN010140R1213	5/116
B7-30-01-P-03	GJL1311009R0013	3/16	BC7-30-10-1.4-81	GJL1313001R8101	3/6	CA4-22E	15BN010140R1022	5/116
B7-30-01-P-80	GJL1311009R8010	3/16	BC7-30-10-16	GJL1313001R1106	3/3	CA4-22M	15BN010140R1122	5/116
B7-30-01-P-84	GJL1311009R8014	3/16	BC7-30-10-2.4-51	GJL1313001R5101	3/6	CA4-22N	15BN010140R1222	5/116
B7-30-01-P-85	GJL1311009R8015	3/16	BC7-30-10-P-01	GJL1313009R0101	3/17	CA4-22U	15BN010140R1322	5/116
B7-30-10-01	GJL1311001R0101	3/2	BC7-30-10-P-03	GJL1313009R0103	3/17	CA4-31E	15BN010140R1031	5/116
B7-30-10-02	GJL1311001R0102	3/2	BC7-30-10-P-04	GJL1313009R0104	3/17	CA4-31M	15BN010140R1131	5/116
B7-30-10-03	GJL1311001R0103	3/2	BC7-30-10-P-05	GJL1313009R0105	3/17	CA4-31N	15BN010140R1231	5/116
B7-30-10-80	GJL1311001R8100	3/2	BC7-30-10-P-07	GJL1313009R0107	3/17	CA4-31U	15BN010140R1331	5/116
B7-30-10-84	GJL1311001R8104	3/2	BC7-30-10-P-1.4-81	GJL1313009R8101	3/22	CA4-40E	15BN010140R1040	5/116
B7-30-10-85	GJL1311001R8105	3/2	BC7-30-10-P-16	GJL1313009R1106	3/17	CA4-40N	15BN010140R1240	5/116
B7-30-10-P-01	GJL1311009R0101	3/16	BC7-30-10-P-2.4-51	GJL1313009R5101	3/22	CA4-40U	15BN010140R1340	5/116
B7-30-10-P-02	GJL1311009R0102	3/16	BEA110/495	15BN084506R1000	5/136	CA5-01	15BN010010R1001	5/122
B7-30-10-P-03	GJL1311009R0103	3/16	BEA16-3	15BN081006T1000	4/9	CA5-04E	15BN010040R1004	5/122
B7-30-10-P-80	GJL1311009R8100	3/16	BEA16-4	15BN081306T1000	5/119	CA5-04M	15BN010040R1104	5/122
B7-30-10-P-84	GJL1311009R8104	3/16	BEA185/T3	15FN084706R1003	5/137	CA5-04U	15BN010040R1304	5/122
B7-30-10-P-85	GJL1311009R8105	3/16	BEA185/T4	15FN084706R1005	5/137	CA5-10	15BN010010R1010	5/122
B7-40-00-01	GJL1311201R0001	3/8	BEA185D/T3	15FN084706R1004	5/137	CA5-11/11E	15BN010040R1018	5/122
B7-40-00-02	GJL1311201R0002	3/8	BEA185D/T4	15FN084706R1006	5/137	CA5-11/11M	15BN010040R1118	5/122
B7-40-00-03	GJL1311201R0003	3/8	BEA210/T4	15FN085106R1003	5/137	CA5-13M	15BN010040R1113	5/122
B7-40-00-80	GJL1311201R8000	3/8	BEA210D/T4	15FN085106R1005	5/137	CA5-22E	15BN010040R1022	5/122
B7-40-00-84	GJL1311201R8004	3/8	BEA26-4	15BN082306T1000	5/119	CA5-22M	15BN010040R1122	5/122
B7D-30-01-01	GJL1317001R0011	3/3	BEA300/T5	15FN085106R1004	5/137	CA5-22U	15BN010040R1322	5/122
B7D-30-01-05	GJL1317001R0015	3/3	BEA300D/T5	15FN085506R1003	5/137	CA5-31E	15BN010040R1031	5/122
B7D-30-10-01	GJL1317001R0101	3/3	BEA300H/T5	15FN085307R1002	5/137	CA5-31M	15BN010040R1131	5/122
B7D-30-10-05	GJL1317001R0105	3/3	BEA38-4	15BN082306T1000	5/119	CA5-31U	15BN010040R1331	5/122
B7D-40-00-01	GJL1317201R0001	3/9	BEA40/450	15BN083206R1000	5/136	CA5-40E	15BN010040R1040	5/122
B7D-40-00-05	GJL1317201R0005	3/9	BEA460H/T4	15FN085907R1000	5/137	CA5-40U	15BN010040R1340	5/122
B7S-30-01-1.7-71	GJL1313001R7011	3/6	BEA50/450	15BN083506R1000	5/136	CA6-11E	GJL1201317R0002	3/24
B7S-30-01-2.8-72	GJL1313001R7012	3/6	BEA7/132	15BN080906R1002	3/24	CA6-11E-P	GJL1201319R0002	3/24
B7S-30-10-1.7-71	GJL1313001R7101	3/6	BEA7/325	15BN080906R1001	3/24	CA6-11K	GJL1201317R0001	3/25
B7S-30-10-2.8-72	GJL1313001R7102	3/6	BEA75/495	15BN084106R1000	5/136	CA6-11K-P	GJL1201319R0001	3/25
BA4	15NA235156R2700	5/120	BEA750/T5	15FN086106R1001	5/137	CA6-11M	GJL1201317R0003	3/24
BA5-50	15BN110000R1000	5/125	BEA750/T6	15FN086106R1000	5/137	CA6-11M-P	GJL1201319R0003	3/24
BB3	15BN111020R1000	4/35	BEA750D/T5	15FN086106R1003	5/137	CA6-11N	GJL1201317R0004	3/24
BB4	15BN110120W1000	5/117	BEA750D/T6	15FN086106R1002	5/137	CA6-11N-P	GJL1201319R0004	3/24
BC6-21-10-P-01	GJL1213109R0101	3/17	BED110	15FN084503R1000	5/140	CAF6-02E	GJL1201330R01010	3/24
BC6-21-10-P-03	GJL1213109R0103	3/17	BED145A	15FN084703R1000	5/140	CAF6-02K	GJL1201330R0009	3/25
BC6-21-10-P-04	GJL1213109R0104	3/17	BED185	15FN084903R1000	5/140	CAF6-02M	GJL1201330R0011	3/24
BC6-21-10-P-05	GJL1213109R0105	3/17	BED210	15FN085103R1000	5/140	CAF6-02N	GJL1201330R0012	3/24
BC6-21-10-P-16	GJL1213109R1106	3/17	BED300	15FN085303R1000	5/140	CAF6-11E	GJL1201330R0002	3/24
BC6-22-00-01	GJL1213501R0001	3/9	BED400	15FN085503R1000	5/140	CAF6-11K	GJL1201330R0001	3/25
BC6-22-00-02	GJL1213501R0002	3/9	BED460	15FN085703R1000	5/140	CAF6-11M	GJL1201330R0003	3/24
BC6-22-00-03	GJL1213501R0003	3/9	BED50	15BN083503R1000	5/140	CAF6-11N	GJL1201330R0004	3/24
BC6-22-00-04	GJL1213501R0004	3/9	BED50-1	15BN083503R1001	5/140	CAF6-20E	GJL1201330R0006	3/24
BC6-22-00-05	GJL1213501R0005	3/9	BED580	15FN085903R1000	5/140	CAF6-20K	GJL1201330R0005	3/25
BC6-22-00-07	GJL1213501R0007	3/9	BED75	15BN084103R1000	5/140	CAF6-20M	GJL1201330R0007	3/24
BC6-22-00-16	GJL1213501R1006	3/9	BED750	15FN086103R1000	5/140	CAF6-20N	GJL1201330R0008	3/24
BC6-30-01-01	GJL1213001R0011	3/3	BED75-1	15BN084103R1001	5/140	CAL16-11A	SK829002-A	5/148
BC6-30-01-03	GJL1213001R0013	3/3	BED95	15FN084303R1000	5/140	CAL16-11B	SK829002-B	5/148
BC6-30-01-04	GJL1213001R0014	3/3	BEF185/OESA250	15FN084908R1000	5/138	CAL16-11C	SK829002-C	5/148
BC6-30-01-05	GJL1213001R0015	3/3	BEF185H/OESA250	15FN084709R1000	5/138	CAL16-11D	SK829002-D	5/148
BC6-30-01-07	GJL1213001R0017	3/3	BEF300/OESA400	15FN085108R1000	5/138	CAL18-11	15FN010720R1011	5/122
BC6-30-01-1.4-81	GJL1213001R8011	3/6	BEF300H/OESA400	15FN085109R1000	5/138	CAL18-11B	15FN010720R3311	5/122
BC6-30-01-16	GJL1213001R1016	3/3	BEF460/OESA400	15FN085708R1000	5/138	CAL4-11	15BN010120R1011	5/116
BC6-30-01-2.4-51	GJL1213001R5011	3/6	BEF750/OESA800	15FN086108R1000	5/138	CAL4-11-T	15BN010120T1011	5/116
BC6-30-01-P-01	GJL1213009R0011	3/17	BEM110-30	15FN084301R1000	5/139	CAL5-11	15BN010020R1011	5/122
BC6-30-01-P-03	GJL1213009R0013	3/17	BEM185-30	15FN084701R1000	5/139	CAT4-11E	15BN010151R1011	5/116
BC6-30-01-P-04	GJL1213009R0014	3/17	BEM300-30	15FN085101R1000	5/139	CAT4-11M	15BN010151R1111	5/116
BC6-30-01-P-05	GJL1213009R0015	3/17	BEM460-30	15FN085701R1000	5/139	CAT4-11U	15BN010151R1311	5/116
BC6-30-01-P-07	GJL1213009R0017	3/17	BEM750-30	15FN086101R1000	5/139	CC4-01	15BN010111R1001	5/116
BC6-30-01-P-1.4-81	GJL1213009R8011	3/22	BEM75-30	15BN083501R1000	5/139	CC4-10	15BN010111R1010	5/116
BC6-30-01-P-16	GJL1213009R1016	3/17	BER16-4	15BN081311R1000	5/119	CC5-01	15BN010011R1001	5/122
BC6-30-01-P-2.4-51	GJL1213009R5011	3/22	BER16C-3	15BN081012R1000	4/9	CC5-10	15BN010011R1010	5/122
BC6-30-10-01	GJL1213001R0101	3/3	BER38-4	15BN082311R1000	5/119	CCL16-11E	SK829002-E	5/148
BC6-30-10-03	GJL1213001R0103	3/3	BER40V	15BN082411R1000	5/139	CK1-02	15AM301901R1003	2/15
BC6-30-10-04	GJL1213001R0104	3/3	BES110	15FN084304R1000	5/139	CK-11	15AM101943R0001	2/45
BC6-30-10-05	GJL1213001R0105	3/3	BES185	15FN084704R1000	5/139	CK1-11	15AM301901R1001	2/15
BC6-30-10-07	GJL1213001R0107	3/3	BES300	15FN085104R1000	5/139	CK1-20	15AM301901R1002	2/15
BC6-30-10-1.4-81	GJL1213001R8101	3/6	BES460	15FN085704R1000	5/139	DB140E	15AZ301110R1002	6/43
BC6-30-10-16	GJL1213001R1106	3/3	BES750	15FN086104R1000	5/139	DB16	15AZ701901R0001	6/2
BC6-30-10-2.4-51	GJL1213001R5101	3/6	BES75-30	15BN083504R1000	5/139	DB16E	15AX101110R0001	6/43
BC6-30-10-P-01	GJL1213009R0101	3/17	BES75-40	15BN083302R1000	5/139	DB200	15AZ401110R0001	6/27
BC6-30-10-P-03	GJL1213009R0103	3/17	BEY16-4	15BN081313R2000	5/119	DB25/25A	15AZ201108R0001	6/14
BC6-30-10-P-04	GJL1213009R0104	3/17	BEY16C-3	15BN081018R2000	4/9	DB25/32A	15AZ201108R0002	6/14
BC6-30-10-P-05	GJL1213009R0105	3/17	BEY38-4	15BN082713R2000	5/119			

Index

Type classification

Type	Order code	Page	Type	Order code	Page	Type	Order code	Page
DMS325-G	1SAM101941R1000	2/47	K6-40E-85	GJH1211001R8405	3/12	LT210-EK	SK178001-KB	5/149
DMS325-Y	1SAM101941R1001	2/47	K6-40E-P-01	GJH1211009R0401	3/20	LT300-AC	1SFN125101R1000	5/132
DR25-A-110	1SAZ201504R0003	6/14	K6-40E-P-02	GJH1211009R0402	3/20	LT300-AL	1SFN125103R1000	5/132
DR25-A-220/380	1SAZ201504R0005	6/14	K6-40E-P-03	GJH1211009R0403	3/20	LT300-AY	1SFN125104R1000	5/132
DR25-A-24	1SAZ201504R0001	6/14	K6-40E-P-80	GJH1211009R8400	3/20	LT320E	1SAX601904R0001	6/48
DR25-A-48	1SAZ201504R0002	6/14	K6-40E-P-84	GJH1211009R8404	3/20	LT460-AC	1SFN125701R1000	5/132
DR25-A-500	1SAZ201504R0006	6/14	K6-40E-P-85	GJH1211009R8405	3/20	LT460-AL	1SFN125703R1000	5/132
DS25-A-110	1SAZ201501R0003	6/14	K6S-22Z-1.7-71	GJH1213001R7221	3/14	LT500E	1SAX701904R0001	6/51
DS25-A-220/380	1SAZ201501R0005	6/14	K6S-22Z-2.8-72	GJH1213001R7222	3/14	LT550-EK	SK178001-LB	5/149
DS25-A-24	1SAZ201501R0001	6/14	K6S-31Z-1.7-71	GJH1213001R7311	3/14	LT6-B	GJL1201906R0001	3/25
DS25-A-500	1SAZ201501R0006	6/14	K6S-31Z-2.8-72	GJH1213001R7312	3/14	LT750-AC	1SFN126101R1000	5/132
DT450/A185	1SAZ501901R1001	6/35	K6S-40E-1.7-71	GJH1213001R7401	3/14	LT750-AL	1SFN126103R1000	5/132
DT450/A300	1SAZ501902R1001	6/35	K6S-40E-2.8-72	GJH1213001R7402	3/14	LT800E	1SAX801904R0001	6/51
DX25	1SAZ201307R0002	6/14	KA450	1SAM41908R1001	2/27	LW110	1SFN074307R1000	5/133
DX495	1SAM401912R1001	2/27	KA495	1SAM501901R1001	2/27	LW1250	1SFN076407R1000	5/133
E1250DU-1250	1SFA739001R1000	6/51	KA495C	1SAM501902R1001	2/27	LW185	1SFN074707R1000	5/133
E140DU-140	1SAX321001R1101	6/39	KC6-22Z-01	GJH1213001R0221	3/13	LW300	1SFN075107R1000	5/133
E16DU-0.32	1SAX111001R1101	6/39	KC6-22Z-04	GJH1213001R0224	3/13	LW460	1SFN075707R1000	5/133
E16DU-1.0	1SAX111001R1102	6/39	KC6-22Z-05	GJH1213001R0225	3/13	LW750	1SFN076107R1000	5/133
E16DU-18.9	1SAX111001R1105	6/39	KC6-22Z-07	GJH1213001R0227	3/13	LX185	1SFN074710R1000	5/133
E16DU-2.7	1SAX111001R1103	6/39	KC6-22Z-13	GJH1213001R1223	3/13	LX300	1SFN075110R1000	5/133
E16DU-6.3	1SAX111001R1104	6/39	KC6-22Z-16	GJH1213001R1226	3/13	LX460	1SFN075710R1000	5/133
E200DU-200	1SAX511001R1101	6/48	KC6-22Z-P-01	GJH1213009R0221	3/21	LX750	1SFN076110R1000	5/133
E320DU-320	1SAX521001R1101	6/48	KC6-22Z-P-04	GJH1213009R0224	3/21	LY110	1SFN074303R1000	5/135
E45DU-30	1SAX211001R1101	6/39	KC6-22Z-P-05	GJH1213009R0225	3/21	LY16-4	1SBN071303T1000	5/120
E45DU-45	1SAX211001R1102	6/39	KC6-22Z-P-07	GJH1213009R0227	3/21	LY185	1SFN074703R1000	5/135
E500DU-500	1SAX711001R1101	6/51	KC6-22Z-P-16	GJH1213009R1226	3/21	LY300	1SFN075103R1000	5/135
E800DU-800	1SAX811001R1101	6/51	KC6-31Z-01	GJH1213001R0311	3/13	LY38-4	1SBN072303T1000	5/120
E80DU-80	1SAX311001R1101	6/39	KC6-31Z-04	GJH1213001R0314	3/13	LY460	1SFN075703R1000	5/135
EF19-0.32	1SAX121001R1101	6/44	KC6-31Z-05	GJH1213001R0315	3/13	LY750	1SFN076103R1000	5/135
EF19-1.0	1SAX121001R1102	6/44	KC6-31Z-07	GJH1213001R0317	3/13	LZ185-2C/120	1SFN074709R1000	5/134
EF19-18.9	1SAX121001R1105	6/44	KC6-31Z-1.4-81	GJH1213001R8311	3/14	MO132-0.16	1SAM360000R1001	2/18
EF19-2.7	1SAX121001R1103	6/44	KC6-31Z-13	GJH1213001R1313	3/13	MO132-0.25	1SAM360000R1002	2/18
EF19-6.3	1SAX121001R1104	6/44	KC6-31Z-16	GJH1213001R1316	3/13	MO132-0.4	1SAM360000R1003	2/18
EF45-30	1SAX221001R1101	6/44	KC6-31Z-2.4-51	GJH1213001R5311	3/14	MO132-0.63	1SAM360000R1004	2/18
EF45-45	1SAX221001R1102	6/44	KC6-31Z-P-01	GJH1213009R0311	3/21	MO132-1.0	1SAM360000R1005	2/18
EK1000-40-11	SK827044-AR	5/72	KC6-31Z-P-04	GJH1213009R0314	3/21	MO132-1.6	1SAM360000R1006	2/18
EK1000-40-21	SK827044-DC	5/73	KC6-31Z-P-05	GJH1213009R0315	3/21	MO132-10	1SAM360000R1010	2/18
EK110-40-11	SK824440-AE	5/68	KC6-31Z-P-1.4-81	GJH1213009R8311	3/23	MO132-12	1SAM360000R1012	2/18
EK110-40-21	SK824440-DB	5/69	KC6-31Z-P-16	GJH1213009R1316	3/21	MO132-16	1SAM360000R1011	2/18
EK150-40-11	SK824441-AE	5/68	KC6-31Z-P-2.4-51	GJH1213009R5311	3/23	MO132-2.5	1SAM360000R1007	2/18
EK150-40-21	SK824441-DB	5/69	KC6-40E-01	GJH1213001R0401	3/13	MO132-20	1SAM360000R1013	2/18
EK175-40-11	SK825440-AE	5/70	KC6-40E-04	GJH1213001R0404	3/13	MO132-25	1SAM360000R1014	2/18
EK175-40-21	SK825440-DB	5/71	KC6-40E-05	GJH1213001R0405	3/13	MO132-32	1SAM360000R1015	2/18
EK210-40-11	SK825441-AE	5/70	KC6-40E-07	GJH1213001R0407	3/13	MO132-4.0	1SAM360000R1008	2/18
EK210-40-21	SK825441-DB	5/71	KC6-40E-1.4-81	GJH1213001R8401	3/14	MO132-6.3	1SAM360000R1009	2/18
EK370-40-11	SK827040-AR	5/70	KC6-40E-13	GJH1213001R1403	3/13	MO325-0.4	1SAM160000R1003	2/49
EK370-40-21	SK827040-DC	5/71	KC6-40E-16	GJH1213001R1406	3/13	MO325-0.63	1SAM160000R1004	2/49
EK550-40-11	SK827041-AR	5/70	KC6-40E-2.4-51	GJH1213001R5401	3/14	MO325-1	1SAM160000R1005	2/49
EK550-40-21	SK827041-DC	5/71	KC6-40E-P-01	GJH1213009R0401	3/21	MO325-1.6	1SAM160000R1006	2/49
FS116	1SAM201909R1001	2/6	KC6-40E-P-04	GJH1213009R0404	3/21	MO325-12.5	1SAM160000R1011	2/49
HK-02	1SAM101901R0003	2/45	KC6-40E-P-05	GJH1213009R0405	3/21	MO325-16	1SAM160000R1012	2/49
HK1-02	1SAM201902R1003	2/7	KC6-40E-P-07	GJH1213009R0407	3/21	MO325-2.5	1SAM160000R1007	2/49
HK-11	1SAM101901R0001	2/45	KC6-40E-P-1.4-81	GJH1213009R8401	3/23	MO325-20	1SAM160000R1013	2/49
HK1-11	1SAM201902R1001	2/7	KC6-40E-P-16	GJH1213009R1406	3/21	MO325-25	1SAM160000R1014	2/49
HK1-20	1SAM201902R1002	2/7	KC6-40E-P-2.4-51	GJH1213009R5401	3/23	MO325-4	1SAM160000R1008	2/49
HK1-20L	1SAM201902R1004	2/7	KH210	SK825400-AE	5/155	MO325-6.3	1SAM160000R1009	2/49
HK-20	1SAM101901R0002	2/45	KH300	SK826400-AE	5/155	MO325-9	1SAM160000R1010	2/49
HK4-11	1SAM401901R1001	2/28	KH800	SK828100-AR	5/155	MO450-40	1SAM460000R1005	2/32
HK4-W	1SAM401901R1002	2/28	KP210	SK825450-DB	5/156	MO450-45	1SAM460000R1006	2/32
HKF-11	1SAM101928R0001	2/45	KP300	SK826450-DB	5/156	MO450-50	1SAM460000R1007	2/32
HKF1-11	1SAM201901R1001	2/7	KP800	SK828150-DC	5/156	MO495-100	1SAM560000R1010	2/32
HKF-20	1SAM101928R0002	2/45	KWK1000	5223351-AN	5/154	MO495-63	1SAM560000R1007	2/32
HKS4-02	1SAM401902R1003	2/28	KWK110	5223351-AH	5/154	MO495-75	1SAM560000R1008	2/32
HKS4-11	1SAM401902R1001	2/28	KWK150	5223351-AK	5/154	MO495-90	1SAM560000R1009	2/32
HKS4-20	1SAM401902R1002	2/28	KWK175	5223351-AL	5/154	MO496-100	1SAM590000R1010	2/32
HTP500-BA4	1SNA235712R2400	5/120	KWK210	5223351-AM	5/154	MO496-16	1SAM590000R1001	2/32
IB132-G	1SAM201911R1010	2/8	KWK370	5223351-Y	5/154	MO496-20	1SAM590000R1002	2/32
IB132-Y	1SAM201911R1011	2/8	KWK550	5223351-Z	5/154	MO496-25	1SAM590000R1003	2/32
IB325-G	1SAM101940R1000	2/47	KZK1000	SK827204-F	5/154	MO496-32	1SAM590000R1004	2/32
IB325-Y	1SAM101940R1001	2/47	KZK110	SK824204-A	5/154	MO496-40	1SAM590000R1005	2/32
K6-22Z-01	GJH1211001R0221	3/12	KZK150	SK824204-B	5/154	MO496-50	1SAM590000R1006	2/32
K6-22Z-02	GJH1211001R0222	3/12	KZK175	SK825204-A	5/154	MO496-63	1SAM590000R1007	2/32
K6-22Z-03	GJH1211001R0223	3/12	KZK210	SK825204-B	5/154	MO496-75	1SAM590000R1008	2/32
K6-22Z-80	GJH1211001R8220	3/12	KZK370	SK827204-A	5/154	MO496-90	1SAM590000R1009	2/32
K6-22Z-84	GJH1211001R8224	3/12	KZK550	SK827204-B	5/154	MS116-0.16	1SAM250000R1001	2/2
K6-22Z-85	GJH1211001R8225	3/12	LB6	GJL1201902R0001	3/25	MS116-0.16-HKF1-11	1SAM250005R1001	2/2
K6-22Z-P-01	GJH1211009R0221	3/20	LB6-CA	GJL1201903R0001	3/25	MS116-0.25	1SAM250000R1002	2/2
K6-22Z-P-02	GJH1211009R0222	3/20	LD10	1SFN074308R1000	5/130	MS116-0.25-HKF1-11	1SAM250005R1002	2/2
K6-22Z-P-03	GJH1211009R0223	3/20	LD40	1SBN072808R1000	5/130	MS116-0.4	1SAM250000R1003	2/2
K6-22Z-P-80	GJH1211009R8220	3/20	LD75	1SBN073508R1000	5/130	MS116-0.4-HKF1-11	1SAM250005R1003	2/2
K6-22Z-P-84	GJH1211009R8224	3/20	LDC4	1SBN070156T1000	5/120	MS116-0.63	1SAM250000R1004	2/2
K6-22Z-P-85	GJH1211009R8225	3/20	LF40	1SBN073205R1000	5/135	MS116-0.63-HKF1-11	1SAM250005R1004	2/2
K6-31Z-01	GJH1211001R0311	3/12	LF75	FPFN472735R0001	5/135	MS116-1.0	1SAM250000R1005	2/2
K6-31Z-02	GJH1211001R0312	3/12	LH75	FPFN472734R0001	5/135	MS116-1.0-HKF1-11	1SAM250005R1005	2/2
K6-31Z-03	GJH1211001R0313	3/12	LK110	1SFN074352R1000	5/131	MS116-1.6	1SAM250000R1006	2/2
K6-31Z-80	GJH1211001R8310	3/12	LK75-F	1SBN073552R1002	5/131	MS116-1.6-HKF1-11	1SAM250005R1006	2/2
K6-31Z-84	GJH1211001R8314	3/12	LP75-L	1SBN073552R1003	5/131	MS116-10	1SAM250000R1010	2/2
K6-31Z-85	GJH1211001R8315	3/12	LP185	1SFN074712R1000	5/135	MS116-10.0-HKF1-11	1SAM250005R1010	2/2
K6-31Z-P-01	GJH1211009R0311	3/20	LP300	1SFN075112R1000	5/135	MS116-12	1SAM250000R1012	2/2
K6-31Z-P-02	GJH1211009R0312	3/20	LP460	1SFN075712R1000	5/135	MS116-12.0-HKF1-11	1SAM250005R1012	2/2
K6-31Z-P-03	GJH1211009R0313	3/20	LP6	GJL1201907R0001	3/24	MS116-16	1SAM250000R1011	2/2
K6-31Z-P-80	GJH1211009R8310	3/20	LP750	1SFN076112R1000	5/135	MS116-16.0-HKF1-11	1SAM250005R1011	2/2
K6-31Z-P-84	GJH1211009R8314	3/20	LT1000-EK	SK178001-MB	5/149	MS116-2.5	1SAM250000R1007	2/2
K6-31Z-P-85	GJH1211009R8315	3/20	LT150-EK	SK178001-HB	5/149	MS116-2.5-HKF1-11	1SAM250005R1007	2/2
K6-40E-01	GJH1211001R0401	3/12	LT185-AC	1SFN124701R1000	5/132	MS116-20	1SAM250005R1013	2/2
K6-40E-02	GJH1211001R0402	3/12	LT185-AL	1SFN124703R1000	5/132	MS116-20-HKF1-11	1SAM250005R1013	2/2
K6-40E-03	GJH1211001R0403	3/12	LT185-AY	1SFN124704R1000	5/132	MS116-25	1SAM250000R1014	2/2
K6-40E-80	GJH1211001R8400	3/12	LT200-A	1SAZ201901R1001	6/31	MS116-25-HKF1-11	1SAM250005R1014	2/2
K6-40E-84	GJH1211001R8404	3/12						

Index

Type classification

Type	Order code	Page	Type	Order code	Page	Type	Order code	Page
MS116-32-HKF1-11	1SAM250005R1015	2/2	NFZ22E-23	1SBH136001R2322	5/109	PR300-2	1SFN095300R1001	5/142
MS116-4.0	1SAM250000R1008	2/2	NFZ31E-20	1SBH136001R2031	5/109	PR400-2	1SFN095700R1002	5/142
MS116-4.0-HKF1-11	1SAM250005R1008	2/2	NFZ31E-21	1SBH136001R2131	5/109	PR460-1	1SFN095700R1000	5/142
MS116-6.3	1SAM250000R1009	2/2	NFZ31E-22	1SBH136001R2231	5/109	PR460-2	1SFN095700R1001	5/142
MS116-6.3-HKF1-11	1SAM250005R1009	2/2	NFZ31E-23	1SBH136001R2331	5/109	PR580-2	1SFN096100R1002	5/142
MS132-0.16	1SAM350000R1001	2/10	NFZ40E-20	1SBH136001R2040	5/109	PR750-1	1SFN096100R1000	5/142
MS132-0.16-HKF1-11	1SAM350005R1001	2/10	NFZ40E-21	1SBH136001R2140	5/109	PR750-2	1SFN096100R1001	5/142
MS132-0.25	1SAM350000R1002	2/10	NFZ40E-22	1SBH136001R2240	5/109	PS1-2-0-65	1SAM201906R1102	2/6
MS132-0.25-HKF1-11	1SAM350005R1002	2/10	NFZ40E-23	1SBH136001R2340	5/109	PS1-2-1-65	1SAM201906R1112	2/6
MS132-0.4	1SAM350000R1003	2/10	NS22E-16	1SBH101001R1622	4/24	PS1-2-2-65	1SAM201906R1122	2/6
MS132-0.4-HKF1-11	1SAM350005R1003	2/10	NS22E-20	1SBH101001R2022	4/24	PS1-3-0-100	1SAM201916R1103	2/6
MS132-0.63	1SAM350000R1004	2/10	NS22E-26	1SBH101001R2622	4/24	PS1-3-0-65	1SAM201906R1103	2/6
MS132-0.63-HKF1-11	1SAM350005R1004	2/10	NS22E-28	1SBH101001R2822	4/24	PS1-3-1-100	1SAM201916R1113	2/6
MS132-1.0	1SAM350000R1005	2/10	NS31E-16	1SBH101001R1631	4/24	PS1-3-1-65	1SAM201906R1113	2/6
MS132-1.0-HKF1-11	1SAM350005R1005	2/10	NS31E-20	1SBH101001R2031	4/24	PS1-3-2-100	1SAM201916R1123	2/6
MS132-1.6	1SAM350000R1006	2/10	NS31E-26	1SBH101001R2631	4/24	PS1-3-2-65	1SAM201906R1123	2/6
MS132-1.6-HKF1-11	1SAM350005R1006	2/10	NS31E-28	1SBH101001R2831	4/24	PS1-4-0-100	1SAM201916R1104	2/6
MS132-10	1SAM350000R1010	2/10	NS40E-16	1SBH101001R1640	4/24	PS1-4-0-65	1SAM201906R1104	2/6
MS132-10.0-HKF1-11	1SAM350005R1010	2/10	NS40E-20	1SBH101001R2040	4/24	PS1-4-1-100	1SAM201916R1114	2/6
MS132-12	1SAM350000R1012	2/10	NS40E-26	1SBH101001R2640	4/24	PS1-4-1-65	1SAM201906R1114	2/6
MS132-12.0-HKF1-11	1SAM350005R1012	2/10	NS40E-28	1SBH101001R2840	4/24	PS1-4-2-65	1SAM201906R1124	2/6
MS132-16	1SAM350000R1011	2/10	NS44E-16	1SBH101001R1644	4/24	PS1-5-0-100	1SAM201916R1105	2/6
MS132-16.0-HKF1-11	1SAM350005R1011	2/10	NS44E-20	1SBH101001R2044	4/24	PS1-5-0-65	1SAM201906R1105	2/6
MS132-2.5	1SAM350000R1007	2/10	NS44E-26	1SBH101001R2644	4/24	PS1-5-1-100	1SAM201916R1115	2/6
MS132-2.5-HKF1-11	1SAM350005R1007	2/10	NS44E-28	1SBH101001R2844	4/24	PS1-5-1-65	1SAM201906R1115	2/6
MS132-20	1SAM350000R1013	2/10	NS53E-16	1SBH101001R1653	4/24	PS1-5-2-65	1SAM201906R1125	2/6
MS132-20-HKF1-11	1SAM350005R1013	2/10	NS53E-20	1SBH101001R2053	4/24	PS3-2-0	1SAM101937R0012	2/44
MS132-25	1SAM350000R1014	2/10	NS53E-26	1SBH101001R2653	4/24	PS3-2-1	1SAM101937R0022	2/44
MS132-25-HKF1-11	1SAM350005R1014	2/10	NS53E-28	1SBH101001R2853	4/24	PS3-2-2	1SAM101937R0032	2/44
MS132-32	1SAM350000R1015	2/10	NS62E-16	1SBH101001R1662	4/24	PS3-3-0	1SAM101937R0013	2/44
MS132-32-HKF1-11	1SAM350005R1015	2/10	NS62E-20	1SBH101001R2062	4/24	PS3-3-1	1SAM101937R0023	2/44
MS132-4.0	1SAM350000R1008	2/10	NS62E-26	1SBH101001R2662	4/24	PS3-4-0	1SAM101937R0014	2/44
MS132-4.0-HKF1-11	1SAM350005R1008	2/10	NS62E-28	1SBH101001R2862	4/24	PS3-4-1	1SAM101937R0024	2/44
MS132-6.3	1SAM350000R1009	2/10	NS71E-16	1SBH101001R1671	4/24	PS3-4-2	1SAM101937R0034	2/44
MS132-6.3-HKF1-11	1SAM350005R1009	2/10	NS71E-20	1SBH101001R2071	4/24	PS3-5-0	1SAM101937R0015	2/44
MS325-0.16	1SAM150000R1001	2/40	NS71E-26	1SBH101001R2671	4/24	PS3-5-1	1SAM101937R0025	2/44
MS325-0.16-HKF11	1SAM150005R0001	2/40	NS71E-28	1SBH101001R2871	4/24	PS3-6-0	1SAM101937R0016	2/44
MS325-0.25	1SAM150000R1002	2/40	NS80E-16	1SBH101001R1680	4/24	PS4-2-0	1SAM401911R1001	2/27
MS325-0.25-HKF11	1SAM150005R0002	2/40	NS80E-20	1SBH101001R2080	4/24	PS4-2-2	1SAM401911R1004	2/27
MS325-0.4	1SAM150000R1003	2/40	NS80E-26	1SBH101001R2680	4/24	PS4-3-0	1SAM401911R1002	2/27
MS325-0.4-HKF11	1SAM150005R0003	2/40	NS80E-28	1SBH101001R2880	4/24	PS4-3-2	1SAM401911R1005	2/27
MS325-0.63	1SAM150000R1004	2/40	NSL22E-81	1SBH103001R8122	4/25	PS4-4-0	1SAM401911R1003	2/27
MS325-0.63-HKF11	1SAM150005R0004	2/40	NSL22E-83	1SBH103001R8322	4/25	PS4-4-2	1SAM401911R1006	2/27
MS325-1	1SAM150000R1005	2/40	NSL22E-86	1SBH103001R8622	4/25	RA5-1	1SBN060300T1000	5/128
MS325-1.6	1SAM150000R1006	2/40	NSL22E-88	1SBH103001R8822	4/25		1SBN060300R1000	5/128
MS325-1.6-HKF11	1SAM150005R0006	2/40	NSL31E-81	1SBH103001R8131	4/25	RC5-1/133	1SBN050100R1001	5/127
MS325-12.5	1SAM150000R1011	2/40	NSL31E-83	1SBH103001R8331	4/25	RC5-1/250	1SBN050100R1002	5/127
MS325-12.5-HKF11	1SAM150005R0011	2/40	NSL31E-86	1SBH103001R8631	4/25	RC5-1/440	1SBN050100R1003	5/127
MS325-16	1SAM150000R1012	2/40	NSL31E-88	1SBH103001R8831	4/25	RC5-1/50	1SBN050100R1000	5/127
MS325-16-HKF11	1SAM150005R0012	2/40	NSL40E-81	1SBH103001R8140	4/25	RC5-2/133	1SBN050200R1001	5/127
MS325-1-HKF11	1SAM150005R0005	2/40	NSL40E-83	1SBH103001R8340	4/25	RC5-2/250	1SBN050200R1002	5/127
MS325-2.5	1SAM150000R1007	2/40	NSL40E-86	1SBH103001R8640	4/25	RC5-2/440	1SBN050200R1003	5/127
MS325-2.5-HKF11	1SAM150005R0007	2/40	NSL44E-81	1SBH103001R8144	4/25	RC5-2/50	1SBN050200R1000	5/127
MS325-20	1SAM150000R1013	2/40	NSL44E-83	1SBH103001R8344	4/25	RC5-3/440	1SFN050300R1003	5/127
MS325-20-HKF11	1SAM150005R0013	2/40	NSL44E-86	1SBH103001R8644	4/25	RC-EH300/415	SK829007-B	5/150
MS325-25	1SAM150000R1014	2/40	NSL44E-88	1SBH103001R8844	4/25	RC-EH300/48	SK829007-A	5/150
MS325-25-HKF11	1SAM150005R0014	2/40	NSL53E-81	1SBH103001R8153	4/25	RC-EH800/110	SK829007-C	5/150
MS325-4	1SAM150000R1008	2/40	NSL53E-83	1SBH103001R8353	4/25	RC-EH800/600	SK829007-D	5/150
MS325-4-HKF11	1SAM150005R0008	2/40	NSL53E-86	1SBH103001R8653	4/25	RT5/150	1SBN050020R1003	5/127
MS325-6.3	1SAM150000R1009	2/40	NSL53E-88	1SBH103001R8853	4/25	RT5/264	1SBN050020R1004	5/127
MS325-6.3-HKF11	1SAM150005R0009	2/40	NSL62E-81	1SBH103001R8162	4/25	RT5/32	1SBN050020R1000	5/127
MS325-9	1SAM150000R1010	2/40	NSL62E-83	1SBH103001R8362	4/25	RT5/65	1SBN050020R1001	5/127
MS325-9-HKF11	1SAM150005R0010	2/40	NSL62E-86	1SBH103001R8662	4/25	RT5/90	1SBN050020R1002	5/127
MS450-40	1SAM450000R1005	2/24	NSL62E-88	1SBH103001R8862	4/25	RV5/133	1SBN050010R1001	5/127
MS450-45	1SAM450000R1006	2/24	NSL71E-81	1SBH103001R8171	4/25	RV5/250	1SBN050010R1002	5/127
MS450-50	1SAM450000R1007	2/24	NSL71E-83	1SBH103001R8371	4/25	RV5/440	1SBN050010R1003	5/127
MS495-100	1SAM550000R1010	2/24	NSL71E-86	1SBH103001R8671	4/25	RV5/50	1SBN050010R1000	5/127
MS495-63	1SAM550000R1007	2/24	NSL71E-88	1SBH103001R8871	4/25	RV-BC6/250	GHV2501902R0002	3/25
MS495-75	1SAM550000R1008	2/24	NSL80E-81	1SBH103001R8871	4/25	RV-BC6/380	GHV2501904R0002	3/25
MS495-90	1SAM550000R1009	2/24	NSL80E-83	1SBH103001R8880	4/25	RV-BC6/60	GHV2501902R0002	3/25
MS497-100	1SAM580000R1010	2/24	NSL80E-86	1SBH103001R8880	4/25	RV-BC6-F/250	GHV2501903R0003	3/25
MS497-32	1SAM580000R1004	2/24	NSL80E-88	1SBH103001R8880	4/25	RV-BC6-F/380	GHV2501904R0003	3/25
MS497-40	1SAM580000R1005	2/24	OESA460H/OESA400	1SFN085709R1000	5/138	RV-BC6-F/60	GHV2501902R0003	3/25
MS497-50	1SAM580000R1006	2/24	QSZA15	1SCA022509R0120	5/138	S1-M1-25	1SAM201907R1101	2/6
MS497-63	1SAM580000R1007	2/24	OX56X105	1SCA108043R1001	2/9	S1-M2-25	1SAM201907R1102	2/6
MS497-75	1SAM580000R1008	2/24	OX56X130	1SCA101655R1001	2/9	S1-M3-25	1SAM201907R1103	2/6
MS497-90	1SAM580000R1009	2/24	OX56X180	1SCA101659R1001	2/9	S1-M3-35	1SAM201913R1103	2/6
MSHD-LB	1SAM201920R1001	2/17	OX56X85	1SCA101647R1001	2/9	S3-M1	1SAM101938R0001	2/44
MSHD-LTB	1SAM201920R1011	2/17	PN110-21	1SFN094301R1000	5/141	S3-M2	1SAM101938R0002	2/44
MSHD-LTY	1SAM201920R1012	2/17	PN110-41	1SFN094303R1000	5/141	S3-M3	1SAM101938R0004	2/44
MSHD-LY	1SAM201920R1002	2/9	PN185-11	1SFN094705R1000	5/141	SA-M1	1SAM401911R1007	2/27
MSMN	1SAM101923R0002	2/9	PN185-21	1SFN094701R1000	5/141	SA1	GJF1101903R0001	2/6
MSMNO	1SAM101923R0012	2/9	PN185-41	1SFN094903R1000	5/141	SA2	GJF1101903R0002	2/6
MSOX-30	1SAM101924R0013	2/9	PN210-22	SK829075-C	5/151	SA3	GJF1101903R0003	2/6
MSOX-32	1SAM101924R0003	2/9	PN300-21	1SFN095101R1000	5/141	SK1-02	1SAM201903R1003	2/7
NF22E-11	1SBH137001R1122	5/108	PN300-22	SK829075-E	5/151	SK-11	1SAM101904R0003	2/45
NF22E-12	1SBH137001R1222	5/108	PN300-41	1SFN095503R1000	5/141	SK1-11	1SAM201903R1001	2/7
NF22E-13	1SBH137001R1322	5/108	PN300A-11	1SFN095105R1000	5/141	SK1-20	1SAM201903R1002	2/7
NF22E-14	1SBH137001R1422	5/108	PN460-11	1SFN095705R1000	5/141	SK4-11	1SAM401904R1001	2/28
NF31E-11	1SBH137001R1131	5/108	PN460-21	1SFN095701R1000	5/141	SPRC	1SNA360010R1500	5/120
NF31E-12	1SBH137001R1231	5/108	PN460-41	1SFN095703R1000	5/141	T16-0-13	1SAZ711201R1005	6/2
NF31E-13	1SBH137001R1331	5/108	PN750-11	1SFN096105R1000	5/141	T16-0-17	1SAZ711201R1008	6/2
NF31E-14	1SBH137001R1431	5/108	PN750-21	1SFN096105R1000	5/141	T16-0-23	1SAZ711201R1009	6/2
NF40E-11	1SBH137001R1140	5/108	PN750-41	1SFN096103R1000	5/141	T16-0-31	1SAZ711201R1013	6/2
NF40E-12	1SBH137001R1240	5/108	PR110-1	1SFN094500R1000	5/142	T16-0-41	1SAZ711201R1014	6/2
NF40E-13	1SBH137001R1340	5/108	PR145-1	1SFN094700R1000	5/142	T16-0-55	1SAZ711201R1017	6/2
NF40E-14	1SBH137001R1440	5/108	PR185-2	1SFN095100R1001	5/142	T16-0-74	1SAZ711201R1021	6/2
NFZ22E-20	1SBH							

Index

Type classification

Type	Order code	Page
T16-10	1SAZ711201R1043	6/2
T16-13	1SAZ711201R1045	6/2
T16-16	1SAZ711201R1047	6/2
T16-2.3	1SAZ711201R1031	6/2
T16-3.1	1SAZ711201R1033	6/2
T16-4.2	1SAZ711201R1035	6/2
T16-5.7	1SAZ711201R1038	6/2
T16-7.6	1SAZ711201R1040	6/2
TA110DU-110	1SAZ411201R1002	6/27
TA110DU-90	1SAZ411201R1001	6/27
TA200DU-110	1SAZ421201R1002	6/31
TA200DU-135	1SAZ421201R1003	6/31
TA200DU-150	1SAZ421201R1004	6/31
TA200DU-175	1SAZ421201R1005	6/31
TA200DU-200	1SAZ421201R1006	6/31
TA200DU-90	1SAZ421201R1001	6/31
TA25DU-0.16	1SAZ211201R1005	6/10
TA25DU-0.25	1SAZ211201R1009	6/10
TA25DU-0.4	1SAZ211201R1013	6/10
TA25DU-0.63	1SAZ211201R1017	6/10
TA25DU-1.0	1SAZ211201R1021	6/10
TA25DU-1.4	1SAZ211201R1023	6/10
TA25DU-1.8	1SAZ211201R1025	6/10
TA25DU-11	1SAZ211201R1043	6/10
TA25DU-14	1SAZ211201R1045	6/10
TA25DU-19	1SAZ211201R1047	6/10
TA25DU-2.4	1SAZ211201R1028	6/10
TA25DU-25	1SAZ211201R1051	6/10
TA25DU-3.1	1SAZ211201R1031	6/10
TA25DU-32	1SAZ211201R1053	6/10
TA25DU-4.0	1SAZ211201R1033	6/10
TA25DU-5.0	1SAZ211201R1035	6/10
TA25DU-6.5	1SAZ211201R1038	6/10
TA25DU-8.5	1SAZ211201R1040	6/10
TA42DU-25	1SAZ311201R1001	6/15
TA42DU-32	1SAZ311201R1002	6/15
TA42DU-42	1SAZ311201R1003	6/15
TA450DU-185	1SAZ511201R1001	6/35
TA450DU-235	1SAZ511201R1002	6/35
TA450DU-310	1SAZ511201R1003	6/35
TA75DU-25	1SAZ321201R1001	6/19
TA75DU-32	1SAZ321201R1002	6/19
TA75DU-42	1SAZ321201R1003	6/19
TA75DU-52	1SAZ321201R1004	6/19
TA75DU-63	1SAZ321201R1005	6/19
TA75DU-80	1SAZ321201R1006	6/19
TA80DU-42	1SAZ331201R1003	6/23
TA80DU-52	1SAZ331201R1004	6/23
TA80DU-63	1SAZ331201R1005	6/23
TA80DU-80	1SAZ331201R1006	6/23
TB450	1SAM401910R1001	2/27
TBC7-22-00-55	GJL1313561R5005	3/10
TBC7-22-00-62	GJL1313561R6002	3/10
TBC7-22-00-68	GJL1313561R6008	3/10
TBC7-30-01-51	GJL1313061R5011	3/7
TBC7-30-01-55	GJL1313061R5015	3/7
TBC7-30-01-62	GJL1313061R6012	3/7
TBC7-30-01-68	GJL1313061R6018	3/7
TBC7-30-10-51	GJL1313061R5101	3/7
TBC7-30-10-55	GJL1313061R5105	3/7
TBC7-30-10-62	GJL1313061R6102	3/7
TBC7-30-10-68	GJL1313061R6108	3/7
TBC7-31-00-55	GJL1313461R5005	3/10
TBC7-31-00-62	GJL1313461R6002	3/10
TBC7-31-00-68	GJL1313461R6008	3/10
TES5-120	1SBN020010R1002	5/126
TES5-24	1SBN020010R1001	5/126
TES5-240	1SBN020010R1003	5/126
TES5-440	1SBN020010R1004	5/126
TEF3-0FF	1SBN021014R1000	4/9
TEF3-ON	1SBN021012R1000	4/9
TF42-0-13	1SAZ721201R1005	6/6
TF42-0-17	1SAZ721201R1008	6/6
TF42-0-23	1SAZ721201R1009	6/6
TF42-0-31	1SAZ721201R1013	6/6
TF42-0-41	1SAZ721201R1014	6/6
TF42-0-55	1SAZ721201R1017	6/6
TF42-0-74	1SAZ721201R1021	6/6
TF42-1.0	1SAZ721201R1023	6/6
TF42-1.3	1SAZ721201R1025	6/6
TF42-1.7	1SAZ721201R1028	6/6
TF42-10	1SAZ721201R1043	6/6
TF42-13	1SAZ721201R1045	6/6
TF42-16	1SAZ721201R1047	6/6
TF42-2.3	1SAZ721201R1031	6/6
TF42-20	1SAZ721201R1049	6/6
TF42-24	1SAZ721201R1051	6/6
TF42-29	1SAZ721201R1052	6/6
TF42-3.1	1SAZ721201R1033	6/6
TF42-35	1SAZ721201R1053	6/6
TF42-38	1SAZ721201R1055	6/6
TF42-4.2	1SAZ721201R1035	6/6
TF42-5.7	1SAZ721201R1038	6/6
TF42-7.6	1SAZ721201R1040	6/6
TKC6-2Z2-51	GJH1213061R5221	3/15
TKC6-2Z2-55	GJH1213061R5225	3/15
TKC6-2Z2-62	GJH1213061R6222	3/15
TKC6-2Z2-68	GJH1213061R6228	3/15
TKC6-31Z-51	GJH1213061R5311	3/15
TKC6-31Z-55	GJH1213061R5315	3/15

Type	Order code	Page
TKC6-31Z-62	GJH1213061R6312	3/15
TKC6-31Z-68	GJH1213061R6318	3/15
TKC6-40E-51	GJH1213061R5401	3/15
TKC6-40E-55	GJH1213061R5405	3/15
TKC6-40E-62	GJH1213061R6402	3/15
TKC6-40E-68	GJH1213061R6408	3/15
TP180DA	1SBN020300R1001	5/123
TP180IA	1SBN020301R1001	5/123
TP40DA	1SBN020300R1000	5/123
TP40IA	1SBN020301R1000	5/123
UA110-30-00	1SFL451022R8000	5/103
UA110-30-00RA	1SFL451024R8000	5/98
UA1-120	1SAM201904R1004	2/7
UA1-208	1SAM201904R1005	2/7
UA1-230	1SAM201904R1006	2/7
UA1-24	1SAM201904R1001	2/7
UA1-400	1SAM201904R1007	2/7
UA1-415	1SAM201904R1008	2/7
UA1-48	1SAM201904R1002	2/7
UA1-60	1SAM201904R1003	2/7
UA16-30-10	1SBL181022R8010	5/101
UA16-30-10RA	1SBL181024R8010	5/96
UA26-30-10	1SBL241022R8010	5/101
UA26-30-10RA	1SBL241024R8010	5/96
UA30-30-10	1SBL281022R8010	5/101
UA30-30-10RA	1SBL281024R8010	5/96
UA4-110	1SAM401905R1001	2/28
UA4-230	1SAM401905R1002	2/28
UA4-24	1SAM401905R1003	2/28
UA4-400	1SAM401905R1003	2/28
UA4-HK-230	1SAM401906R1001	2/28
UA4-HK-400	1SAM401906R1002	2/28
UA50-30-00	1SBL351022R8000	5/102
UA50-30-00RA	1SBL351024R8000	5/97
UA63-30-00	1SBL371022R8000	5/102
UA63-30-00RA	1SBL371024R8000	5/97
UA75-30-00	1SBL411022R8000	5/102
UA75-30-00RA	1SBL411024R8000	5/97
UA95-30-00	1SFL431022R8000	5/103
UA95-30-00RA	1SFL431024R8000	5/98
UAF-110	1SAM101903R0110	2/45
UAF-230	1SAM101903R0230	2/45
UAF-24	1SAM101903R0024	2/45
UAF-400	1SAM101903R0400	2/45
UAF-415	1SAM101903R0415	2/45
UAF-48	1SAM101903R0048	2/45
UAF-500	1SAM101903R0500	2/45
UAF-60	1SAM101903R0060	2/45
VAS09EM-16M	1SBK103600M1600	4/16
VAS09EM-20M	1SBK103600M2000	4/16
VAS09EM-26M	1SBK103600M2600	4/16
VAS09EM-28M	1SBK103600M2800	4/16
VAS09SEM-16M	1SBK103800M1600	4/16
VAS09SEM-20M	1SBK103800M2000	4/16
VAS09SEM-26M	1SBK103800M2600	4/16
VAS09SEM-28M	1SBK103800M2800	4/16
VAS12EM-16M	1SBK113600M1600	4/16
VAS12EM-20M	1SBK113600M2000	4/16
VAS12EM-26M	1SBK113600M2600	4/16
VAS12EM-28M	1SBK113600M2800	4/16
VAS12SEM-16M	1SBK113800M1600	4/16
VAS12SEM-20M	1SBK113800M2000	4/16
VAS12SEM-26M	1SBK113800M2600	4/16
VAS12SEM-28M	1SBK113800M2800	4/16
VAS16EM-16M	1SBK123600M1600	4/16
VAS16EM-20M	1SBK123600M2000	4/16
VAS16EM-26M	1SBK123600M2600	4/16
VAS16EM-28M	1SBK123600M2800	4/16
VAS16SEM-16M	1SBK123800M1600	4/16
VAS16SEM-20M	1SBK123800M2000	4/16
VAS16SEM-26M	1SBK123800M2600	4/16
VAS16SEM-28M	1SBK123800M2800	4/16
VASL09EM-81M	1SBK103700M8100	4/17
VASL09EM-83M	1SBK103700M8300	4/17
VASL09EM-86M	1SBK103700M8600	4/17
VASL09EM-88M	1SBK103700M8800	4/17
VASL09SEM-81M	1SBK103900M8100	4/17
VASL09SEM-83M	1SBK103900M8300	4/17
VASL09SEM-86M	1SBK103900M8600	4/17
VASL09SEM-88M	1SBK103900M8800	4/17
VASL12EM-81M	1SBK113700M8100	4/17
VASL12EM-83M	1SBK113700M8300	4/17
VASL12EM-86M	1SBK113700M8600	4/17
VASL12EM-88M	1SBK113700M8800	4/17
VASL12SEM-81M	1SBK113900M8100	4/17
VASL12SEM-83M	1SBK113900M8300	4/17
VASL12SEM-86M	1SBK113900M8600	4/17
VASL12SEM-88M	1SBK113900M8800	4/17
VASL16EM-81M	1SBK123700M8100	4/17
VASL16EM-83M	1SBK123700M8300	4/17
VASL16EM-86M	1SBK123700M8600	4/17
VASL16EM-88M	1SBK123700M8800	4/17
VASL16SEM-81M	1SBK123900M8100	4/17
VASL16SEM-83M	1SBK123900M8300	4/17
VASL16SEM-86M	1SBK123900M8600	4/17
VASL16SEM-88M	1SBK123900M8800	4/17
VB6-30-01-01	GJL1211901R0011	3/4
VB6-30-01-02	GJL1211901R0012	3/4
VB6-30-01-03	GJL1211901R0013	3/4
VB6-30-01-80	GJL1211901R8010	3/4

Type	Order code	Page
VB6-30-01-84	GJL1211901R8014	3/4
VB6-30-01-85	GJL1211901R8015	3/4
VB6-30-01-P-01	GJL1211909R0011	3/18
VB6-30-01-P-02	GJL1211909R0012	3/18
VB6-30-01-P-03	GJL1211909R0013	3/18
VB6-30-01-P-80	GJL1211909R8010	3/18
VB6-30-01-P-84	GJL1211909R8014	3/18
VB6-30-01-P-85	GJL1211909R8015	3/18
VB6-30-10-01	GJL1211901R0101	3/4
VB6-30-10-02	GJL1211901R0102	3/4
VB6-30-10-03	GJL1211901R0103	3/4
VB6-30-10-80	GJL1211901R8100	3/4
VB6-30-10-84	GJL1211901R8104	3/4
VB6-30-10-85	GJL1211901R8105	3/4
VB6-30-10-P-01	GJL1211909R0101	3/18
VB6-30-10-P-02	GJL1211909R0102	3/18
VB6-30-10-P-03	GJL1211909R0103	3/18
VB6-30-10-P-80	GJL1211909R8100	3/18
VB6-30-10-P-84	GJL1211909R8104	3/18
VB6-30-10-P-85	GJL1211909R8105	3/18
VB7-30-01-01	GJL1311901R0011	3/4
VB7-30-01-02	GJL1311901R0012	3/4
VB7-30-01-03	GJL1311901R0013	3/4
VB7-30-01-80	GJL1311901R8010	3/4
VB7-30-01-84	GJL1311901R8014	3/4
VB7-30-01-85	GJL1311901R8015	3/4
VB7-30-01-P-01	GJL1311909R0011	3/18
VB7-30-01-P-02	GJL1311909R0012	3/18
VB7-30-01-P-03	GJL1311909R0013	3/18
VB7-30-01-P-80	GJL1311909R8010	3/18
VB7-30-01-P-84	GJL1311909R8014	3/18
VB7-30-01-P-85	GJL1311909R8015	3/18
VB7-30-10-01	GJL1311901R0101	3/4
VB7-30-10-02	GJL1311901R0102	3/4
VB7-30-10-03	GJL1311901R0103	3/4
VB7-30-10-80	GJL1311901R8100	3/4
VB7-30-10-84	GJL1311901R8104	3/4
VB7-30-10-85	GJL1311901R8105	3/4
VB7-30-10-P-01	GJL1311909R0101	3/18
VB7-30-10-P-02	GJL1311909R0102	3/18
VB7-30-10-P-03	GJL1311909R0103	3/18
VB7-30-10-P-80	GJL1311909R8100	3/18
VB7-30-10-P-84	GJL1311909R8104	3/18
VB7-30-10-P-85	GJL1311909R8105	3/18
VBC6-30-01-01	GJL1213901R0011	3/5
VBC6-30-01-03	GJL1213901R0013	3/5
VBC6-30-01-04	GJL1213901R0014	3/5
VBC6-30-01-05	GJL1213901R0015	3/5
VBC6-30-01-07	GJL1213901R0017	3/5
VBC6-30-01-16	GJL1213901R1016	3/5
VBC6-30-01-P-01	GJL1213909R0011	3/19
VBC6-30-01-P-03	GJL1213909R0013	3/19
VBC6-30-01-P-04	GJL1213909R0014	3/19
VBC6-30-01-P-05	GJL1213909R0015	3/19
VBC6-30-01-P-07	GJL1213909R0017	3/19
VBC6-30-06-P-06	GJL1213909R0106	3/19
VBC6-30-10-01	GJL1213901R0101	3/5
VBC6-30-10-03	GJL1213901R0103	3/5
VBC6-30-10-04	GJL1213901R0104	3/5
VBC6-30-10-05	GJL1213901R0105	3/5</

Index

Type classification

Type	Order code	Page
VM300/460H	1SFN035100R1000	5/124
VM300/460V	1SFN035101R1000	5/124
VM300H	1SFN034700R1000	5/124
VM300V	1SFN034701R1000	5/124
VM4	1SBN030105T1000	5/117
VM5-1	1SBN030100R1000	5/124
VM750H	1SFN035700R1000	5/124
VM750V	1SFN035701R1000	5/124
WB75-A	FPTN372726R1002	5/118
ZA110	1SFN154310R8006	5/144
ZA16	1SBN151410R8006	5/144
ZA185	1SFN154710R8006	5/144
ZA300	1SFN155110R8006	5/144
ZA40	1SBN152410R8006	5/144
ZA75	1SBN153510R8006	5/144
ZAF110	1SFN154370R6906	5/145
ZAF1650	1SFN156570R7026	5/145
ZAF185	1SFN154770R6906	5/145
ZAF300	1SFN155170R6906	5/145
ZAF460	1SFN155770R6906	5/145
ZAF75	1SBN153570R6906	5/145
ZAF750	1SFN156170R6906	5/145
ZL110	1SFN164503R1000	5/143
ZL1250	1SFN166403R1000	5/143
ZL1350	1SFN166503R1000	5/143
ZL145	1SFN164703R1000	5/143
ZL1650	1SFN166703R1000	5/143
ZL185	1SFN164903R1000	5/143
ZL2050	1SFN167003R1000	5/143
ZL210	1SFN165103R1000	5/143
ZL260	1SFN165303R1000	5/143
ZL300	1SFN165503R1000	5/143
ZL400	1SFN165703R1000	5/143
ZL460	1SFN165903R1000	5/143
ZL50	1SBN163503R1000	5/143
ZL580	1SFN166103R1000	5/143
ZL63	1SBN163703R1000	5/143
ZL75	1SBN164103R1000	5/143
ZL750	1SFN166303R1000	5/143
ZL95	1SFN164303R1000	5/143
ZLU110	1SFN164502R1000	5/143
ZLU50	1SBN163502R1000	5/143
ZLU63	1SBN163702R1000	5/143
ZLU75	1SBN164102R1000	5/143
ZLU95	1SFN164302R1000	5/143
ZP1650	1SFN166521R1070	5/145
ZW1650	1SFN166510R1000	5/143
ZW185	1SFN164710R1000	5/143
ZW300	1SFN165110R1000	5/143
ZW460	1SFN165710R1000	5/143
ZW750	1SFN166110R1000	5/143

Type	Order code	Page
------	------------	------

Type	Order code	Page
------	------------	------

Contact us

ABB France

Low Voltage Products Division

10, rue Ampère Z.I. - B.P. 114
F-69685 Chassieu cedex / France

ABB STOTZ-KONTAKT GmbH

Eppelheimer Straße 82
D-69123 Heidelberg / Germany

ABB AB/ Cewe-Control

Motorgränd 20
S-721 61 Västerås / Sweden

You can find the address of your local sales organisation
on the [ABB home page](http://www.abb.com)
<http://www.abb.com/contacts> -> Low Voltage products

Note

We reserve the right to make technical changes or modify the contents of this document without prior notice.

ABB does not accept any responsibility whatsoever for potential errors or possible lack of information in this document.

We reserve all rights in this document and in the subject matter and illustrations contained therein. Any reproduction, disclosure to third parties or utilization of its contents – in whole or in parts – is forbidden without prior written consent of ABB.

Copyright© 2012 ABB - All rights reserved