



MADE IN
ITALY



TOP SELECTION GARDEN 2022 - MODERN RANGE



NEW

NEW

NEW



pag.5

TERESA 50



pag.6

TERESA 90



pag.7

TERESA 160



pag.7

TERESA 260



pag.9

LIVIA 60



pag.9

LIVIA 90



pag.11

LIVIA 160



pag.17

CARLO 800



pag.17

CARLO 400



pag.18

CARLO 250



pag.18

CARLO SPIKE



pag.19

CARLO WALL



pag.19

CARLO-FS



pag.20

AMELIA 800



pag.25

ESTER



pag.25

ESTER WALL



pag.25

ESTER SPIKE



pag.27

ELISA



pag.27

ELISA WALL



pag.27

ELISA SPIKE



pag.29

GABRI REMI-LUCIA



pag.35

ABRAM



pag.37

FRANCA 90



pag.37

FRANCA 90 SPIKE



pag.37

FRANCA 90 1L



pag.37

FRANCA 90 2L



pag.39

MARTA 90



pag.41

MARTA 160



pag.45

MINITOMMY



pag.45

MINITOMMY 2L



pag.47

TOMMY



pag.49

TOMMY 2L



pag.51

GERMANA



pag.53

GIUSEPPE



pag.55

ALDO



pag.57

CECI 90



pag.58

CECI 120



pag.59

CECI 160



pag.61

NINA



pag.63

LORENZA



pag.65

LETI 100 ROUND



pag.66

LETI 100 SQUARE



pag.67

LETI 200



pag.69

LETI 300



pag.65

EXTRALETI 100 ROUND



pag.71

BERTINA



pag.73

BERTA



pag.75

UMBERTA

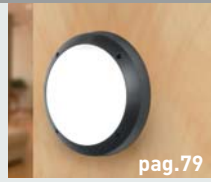

pag.79

GELMI



pag.81

DANZI



pag.83

STUCCHI



pag.83

CECCHI



pag.89

GIORGIO/ROSA



pag.91

BEPPE400



pag.91

VIVI400

NEW PRODUCTS



LIVIA 180



STEVEN



MAMETE SQUARE



MAMETE ROUND



AMELIA 400



AMELIA 250



AMELIA SPIKE



AMELIA WALL



AMELIA-FS

BOLLARD



GABRI REMI-MADDI



PINELA



FRANCY



FRANCY-OP

UP&DOWN

FLOODLIGHT

IN-GROUND



EXTRALETI 100 SQUARE



EXTRALETI 200



EXTRALETI 300

BRICKLIGHT



RITA

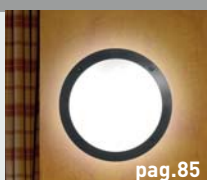

LUCIA



MADDI

BULKHEAD

POLE

TERESA RANGE

DOWNLIGHT / DECKLIGHT



MADE IN ITALY

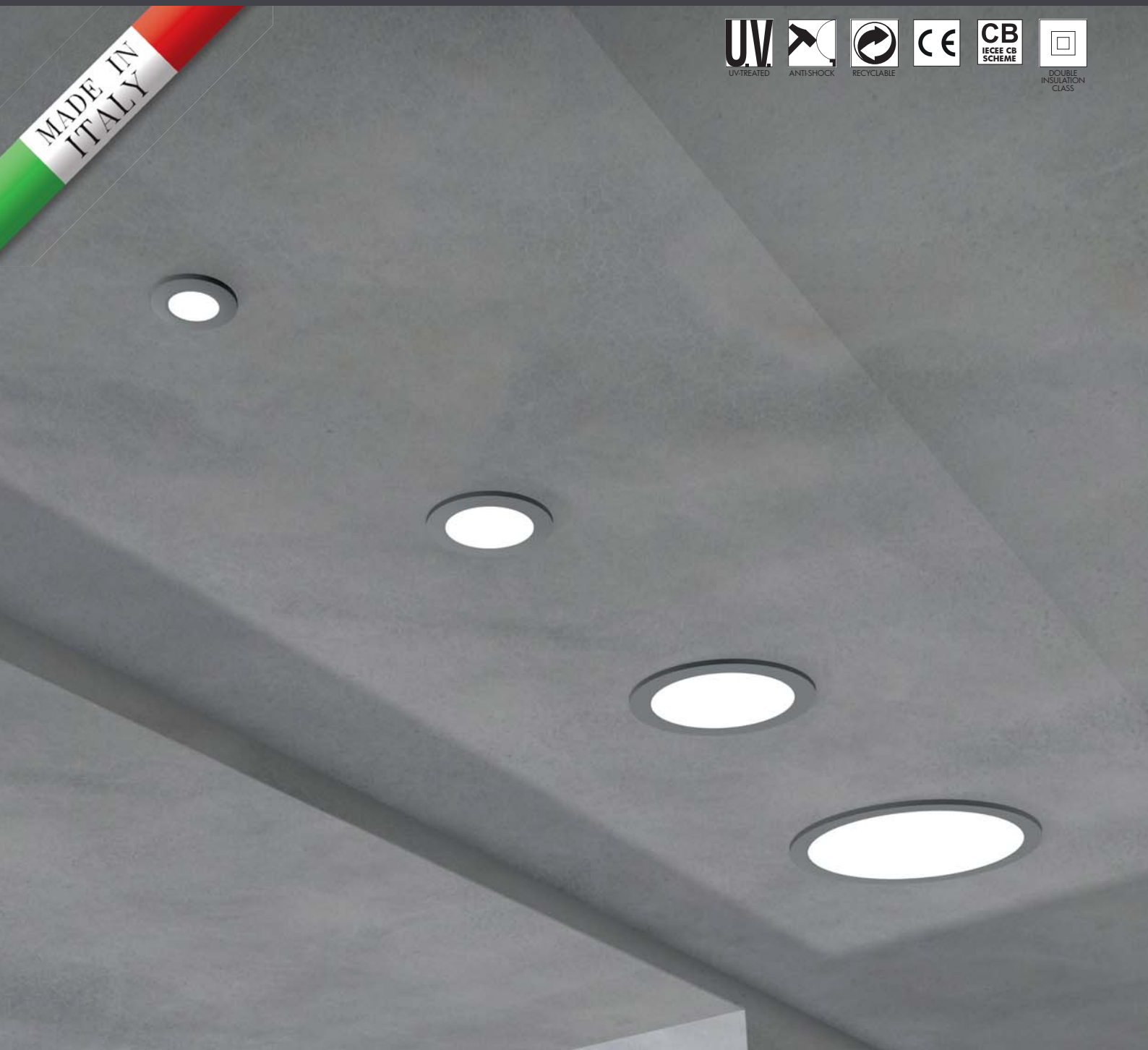

TERESA 50
G9



TERESA 90
GU10



TERESA 160
GX53



TERESA 260
GX53

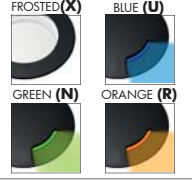

TERESA 50 LED VERSIONS				
LAMP	POWER	LUMINOUS FLUX UP TO	VOLTAGE RANGE	COLOUR TEMPERATURE
	1,7W	150 lm	100-240V 50/60 Hz	4000K
				3000K

AVAILABLE COLORS	
COVER (MOULDED COLOURS)	DIFFUSER
<p>BLACK (A) GREY (L) WHITE (W)</p> 	<p>FROSTED (X) BLUE (U)</p> <p>GREEN (N) ORANGE (R)</p> 

TERESA 50

1,7W	4000K	2L0.000.Z1L
	3000K	2L0.000.Z1R

IP67

LED
G9 LAMP INCLUDED





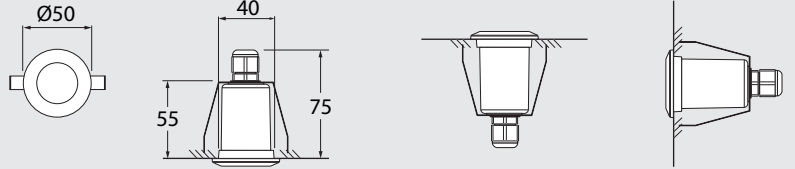

Master box: 75pcs

TERESA 50 SQUARE

1,7W	4000K	2L4.000.Z1L
	3000K	2L4.000.Z1R

IP67

LED
G9 LAMP INCLUDED





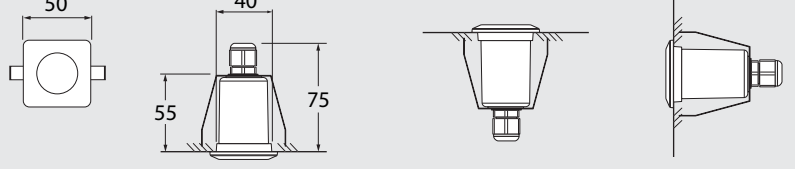

Master box: 75pcs

TERESA 50 1L

1,7W	4000K	2L1.000.Z1L
	3000K	2L1.000.Z1R

IP67

LED
G9 LAMP INCLUDED





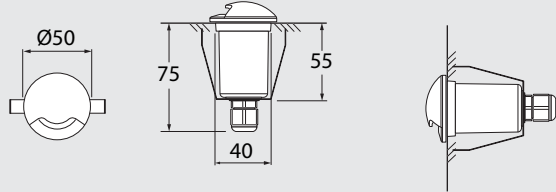

Master box: 75pcs

TERESA 50 2L

1,7W	4000K	2L2.000.Z1L
	3000K	2L2.000.Z1R

IP67







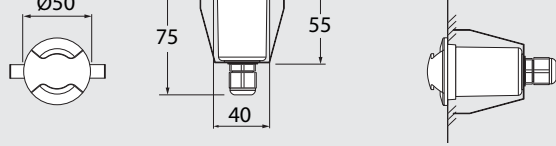



LED
G9 LAMP INCLUDED





Master box: 75pcs

TERESA 90 LED VERSIONS					
LAMP	POWER	LUMINOUS FLUX (Φ TOTAL) UP TO	VOLTAGE RANGE	CCT SETTABLE	
 GU10 LED	3,5W	366 lm	100-240V 50/60 Hz	4000K/2700K	=  35W HALOGEN
 GU10 LED	6W	615 lm	100-240V 50/60 Hz	4000K/2700K	=  50W HALOGEN

AVAILABLE COLORS			
RESIN BODY (MOULDED COLOURS)			DIFFUSER
BLACK (A)	GREY (L)	WHITE (W)	OPAL (Y)
			



RECESSED UNIT
IP20
IP55 OPTICAL UNIT

LED
GU10 LAMP INCLUDED
CCT SET

NEW

CCT SETTABLE

2700 K

4000 K







SDCM < 3 





TERESA 90

3,5W	3L0.000.U1K
6W	3L0.000.L1K



*Master box: **40pcs***

TERESA 160 LED VERSIONS					
LAMP	POWER	LUMINOUS FLUX (Φ TOTAL)	VOLTAGE RANGE	CCT SETTABLE	
	3W	410 lm	100-240V 50/60 Hz	6500K/4000K/3000K	=  40W INCANDESCENT
	7W	975 lm	100-240V 50/60 Hz	6500K/4000K/3000K	=  75W INCANDESCENT
	10W	1290 lm	100-240V 50/60 Hz	6500K/4000K/3000K	=  100W INCANDESCENT

TERESA 260 LED VERSIONS NEW					
LAMP	POWER	LUMINOUS FLUX (Φ TOTAL)	VOLTAGE RANGE	CCT SETTABLE	
	7W	790 lm	100-240V 50/60 Hz	6500K/4000K/2700K	=  60W INCANDESCENT
	11W	1325 lm	100-240V 50/60 Hz	6500K/4000K/2700K	=  100W INCANDESCENT
	18W	2118 lm	100-240V 50/60 Hz	6500K/4000K/2700K	=  150W INCANDESCENT

TERESA 160

IP55
▲ ▲ ▲

LED
GX53 LAMP INCLUDED
CCT SET



NEW

CCT SETTABLE
SDCM <6

3000 K 4000 K 6500 K

3W	4L0.000.G1K
7W	4L0.000.C1K
10W	4L0.000.D1K

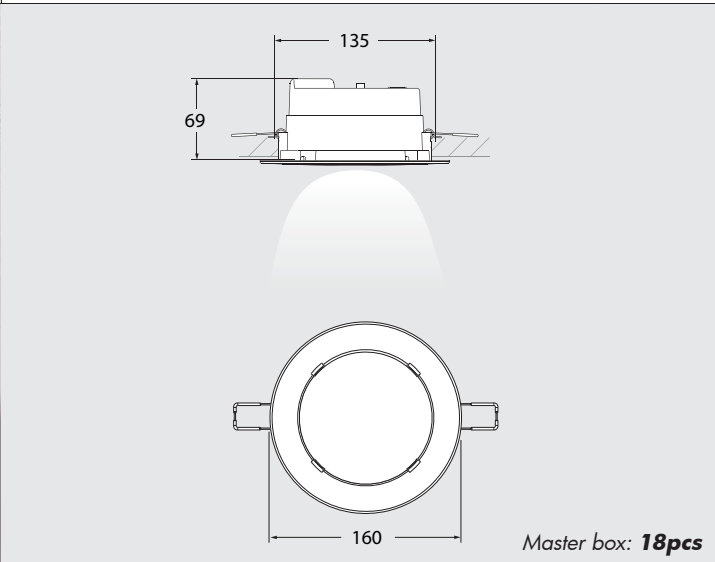

Master box: **18pcs**

TERESA 260

IP55
▲ ▲ ▲

LED
GX53 LAMP INCLUDED
CCT SET



NEW

CCT SETTABLE
SDCM <6

2700 K 4000 K 6500 K

7W	5L0.000.A1K
11W	5L0.000.B1K
18W	5L0.000.E1K

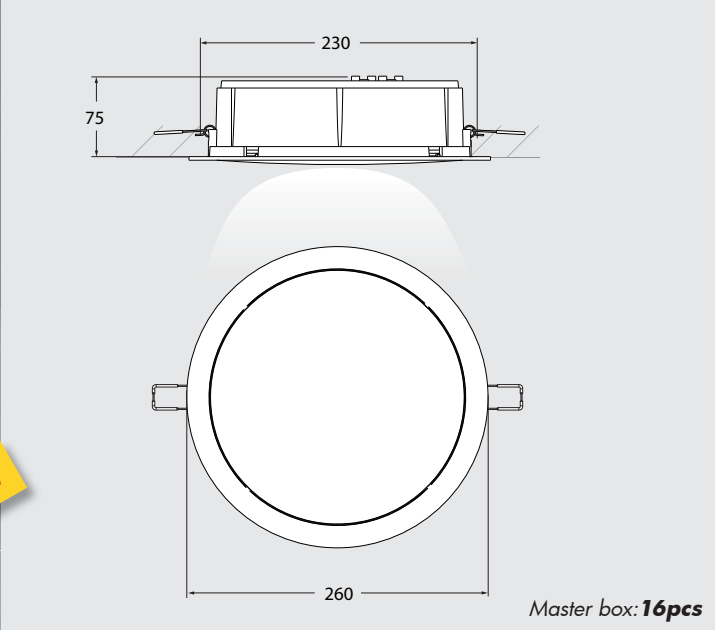

Master box: **16pcs**

LIVIA RANGE





DOWNLIGHT



1A9.000.Z1L

AVAILABLE COLORS			
RESIN BODY <small>(MOULDED COLOURS)</small>			DIFFUSER
BLACK (A)	GREY (L)	WHITE (W)	FROSTED (X)

LIVIA 60 LED VERSIONS				
LAMP	POWER	LUMINOUS FLUX UP TO	VOLTAGE RANGE	COLOUR TEMPERATURE
 G9 LED	1,7W	150 lm	100-240V 50/60 Hz	4000K
				3000K

LIVIA 90 LED VERSIONS					
LAMP	POWER	LUMINOUS FLUX (Ø TOTAL) UP TO	VOLTAGE RANGE	CCT SETTABLE	
 GU10 LED	3,5W	366 lm	100-240V 50/60 Hz	4000K/2700K	=  35W HALOGEN
 GU10 LED	6W	615 lm	100-240V 50/60 Hz	4000K/2700K	=  50W HALOGEN

LIVIA 60



LED
G9 LAMP INCLUDED

1,7W	4000K	1A9.000.Z1L
	3000K	1A9.000.Z1R



Master box: 75pcs

LIVIA 90



LED
GU10 LAMP INCLUDED

CCT SET

3,5W	2A9.000.U1K
6W	2A9.000.L1K



Master box: 30pcs

**NEW VERSION
CCT SETTABLE LAMP**

LIVIA RANGE

DOWNLIGHT



3A9.000.G1K



AVAILABLE COLORS

RESIN BODY (MOULDED COLOURS)

BLACK (A)

GREY (L)







WHITE (W)







DIFFUSER

FROSTED (X)



LIVIA 160 LED VERSIONS					
LAMP	POWER	LUMINOUS FLUX (Φ TOTAL)	VOLTAGE RANGE	CCT SETTABLE	
 GX53	3W	410 lm	100-240V 50/60 Hz	6500K/4000K/3000K	=  40W INCANDESCENT
 GX53	7W	975 lm	100-240V 50/60 Hz	6500K/4000K/3000K	=  75W INCANDESCENT
 GX53	10W	1290 lm	100-240V 50/60 Hz	6500K/4000K/3000K	=  100W INCANDESCENT

LIVIA 180 LED VERSIONS NEW					
LAMP	POWER	LUMINOUS FLUX UP TO	VOLTAGE RANGE	CCT SETTABLE	
 HIGH POWER LED E27	15W	1690 lm	100-240V 50/60 Hz	3000K/ 4000K	=  50W HQI-SON
 HIGH POWER LED E27	30W	3620 lm	100-240V 50/60 Hz	3000K/ 4000K	=  70W HQI-SON

LIVIA 160



LED
GX53 LAMP INCLUDED

CCT SET

3W	3A9.000.G1K
7W	3A9.000.C1K
10W	3A9.000.D1K



Master box: 18pcs

NEW

NEW VERSION
CCT SETTABLE LAMP

LIVIA 180



IP44

LED
E27 HIGH POWER LAMP INCLUDED

CCT SET

15W	4A9.000.R1K	NEW
30W	4A9.000.Q1K	NEW



Master box: 12pcs

NEW

NEW

CCT SETTABLE

3000 K

4000 K

SDCM <6



STEVEN

BOLLARD RANGE





MADE IN ITALY

 UV TREATED	 ANTI-SHOCK	 RECYCLABLE	 CE	 CB IECEE CB SCHEME	 IP67	 DOUBLE INSULATION CLASS
---	--	---	---	---	---	--



ST1.531.Z1R

STEVEN LED VERSIONS				
LAMP	POWER	LUMINOUS FLUX UP TO	VOLTAGE RANGE	COLOUR TEMPERATURE
 G9 LED	1,7W	150 lm	100-240V 50/60 Hz	4000K
				3000K

AVAILABLE COLORS	
BODY	DIFFUSER
(MOULDED COLOURS)	
BLACK (A) GREY (L) WHITE (W)	FROSTED (X) BLUE (U) GREEN (N) ORANGE (R)
	



NEW

STEVEN

LED G9 LAMP INCLUDED	1,7W	4000K ST1.531.Z1L	3000K ST1.531.Z1R
--------------------------------	------	----------------------	----------------------

SPIKE INSTALLATION

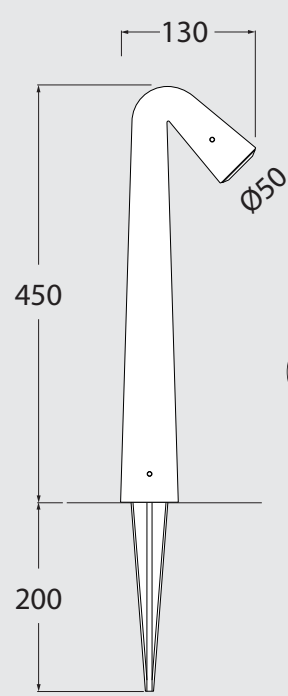

GROUND INSTALLATION

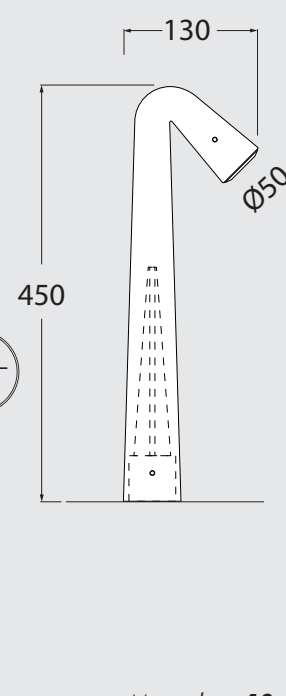

Master box: 10pcs



WALL INSTALLATION

2A3.000.Z1L



1A3.000.Z1L

GROUND INSTALLATION

MAMETE LED VERSIONS				
LAMP	POWER	LUMINOUS FLUX UP TO	VOLTAGE RANGE	COLOUR TEMPERATURE
	1,7W	150 lm	100-240V 50/60 Hz	4000K
				3000K

AVAILABLE COLORS	
BODY (MOULDED COLOURS)	DIFFUSER
<p>BLACK (A) GREY (L) WHITE (W)</p> 	<p>FROSTED (X) BLUE (U) GREEN (N) ORANGE (R)</p> 

MAMETE SQUARE



NEW

LED
G9 LAMP INCLUDED

1,7W	4000K	1A3.000.Z1L
	3000K	1A3.000.Z1R

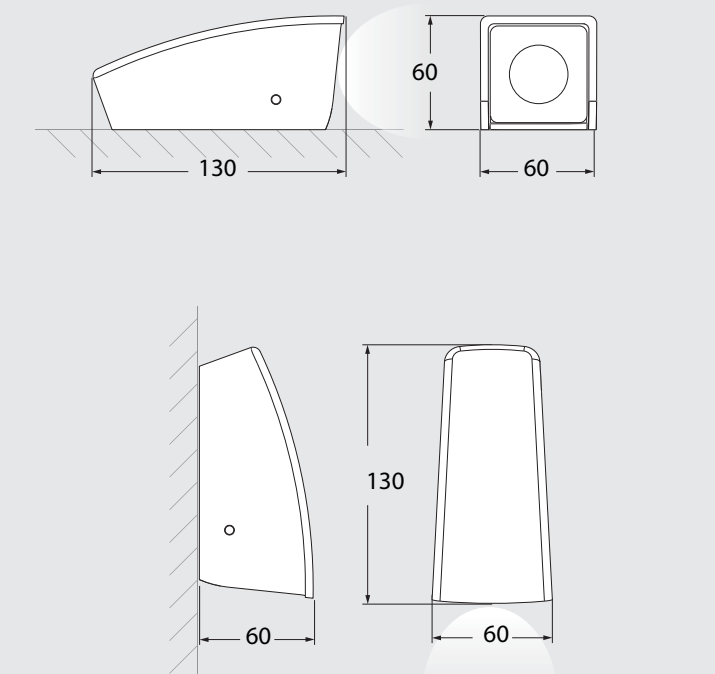

Master box: 50pcs

MAMETE ROUND



NEW

LED
G9 LAMP INCLUDED

1,7W	4000K	2A3.000.Z1L
	3000K	2A3.000.Z1R

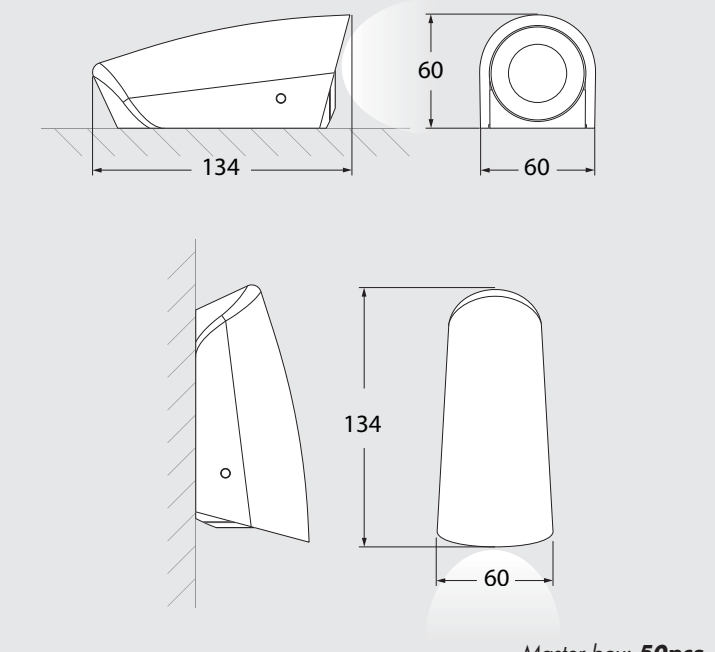

Master box: 50pcs

CARLO / CARLO DECO

BOLLARD RANGE



MADE IN ITALY



DR1.575



DR3.570











DR3.574

CCT SETTABLE

2700 K 4000 K

SDCM <3

CARLO LED VERSIONS					
LAMP	POWER	LUMINOUS FLUX (Φ TOTAL) UP TO	VOLTAGE RANGE	CCT SETTABLE	
 GU10 LED	3,5W	366 lm	100-240V 50/60 Hz	4000K/2700K	=  35W HALOGEN
 GU10 LED	6W	615 lm	100-240V 50/60 Hz	4000K/2700K	=  50W HALOGEN

AVAILABLE COLORS			DIFFUSER
RESIN BODY (MOULDED COLOURS)			
BLACK (A)	GREY (L)	WHITE (W)	CLEAR (X)
			

CARLO 800

LED GU10 LAMP INCLUDED
CCT SET



3,5W	DR1.575.U1K
6W	DR1.575.L1K
3,5W	DR3.575.U1K
6W	DR3.575.L1K

NEW VERSION CCT SETTABLE LAMP



Master box: **6pcs**

CARLO 800 DECO

LED GU10 LAMP INCLUDED
CCT SET



CARLO 400

LED GU10 LAMP INCLUDED
CCT SET



3,5W	DR1.574.U1K
6W	DR1.574.L1K
3,5W	DR3.574.U1K
6W	DR3.574.L1K

NEW VERSION CCT SETTABLE LAMP

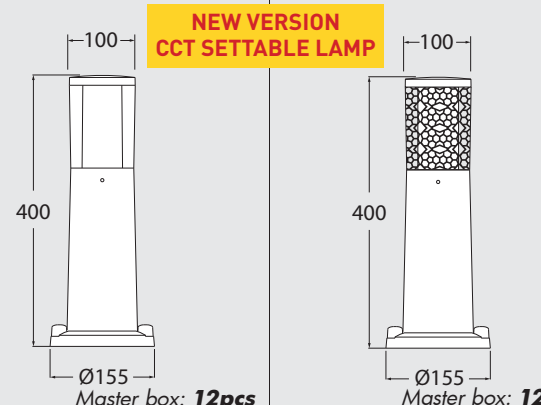





Master box: **12pcs**

CARLO 400 DECO

LED GU10 LAMP INCLUDED
CCT SET



CARLO LED VERSIONS					
LAMP	POWER	LUMINOUS FLUX (Φ TOTAL) UP TO	VOLTAGE RANGE	CCT SETTABLE	
 GU10 LED	3,5W	366 lm	100-240V 50/60 Hz	4000K/2700K	=  35W HALOGEN
 GU10 LED	6W	615 lm	100-240V 50/60 Hz	4000K/2700K	=  50W HALOGEN



CARLO 250

LED
GU10 LAMP INCLUDED

CCT SET



3,5W	DR1.573.U1K
6W	DR1.573.L1K
3,5W	DR3.573.U1K
6W	DR3.573.L1K

NEW VERSION
CCT SETTABLE LAMP



100
250



100
250

Master box: **20pcs**

CARLO 250 DECO

LED
GU10 LAMP INCLUDED

CCT SET



CARLO SPIKE

LED
GU10 LAMP INCLUDED

CCT SET



3,5W	DR1.572.U1K
6W	DR1.572.L1K
3,5W	DR3.572.U1K
6W	DR3.572.L1K

NEW VERSION
CCT SETTABLE LAMP

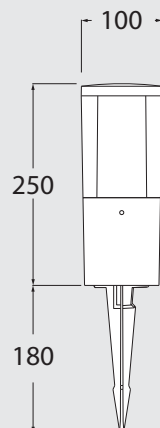

100
250
180

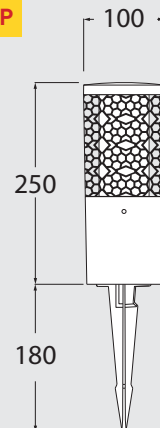

100
250
180





Master box: **20pcs**





CARLO SPIKE DECO

LED
GU10 LAMP INCLUDED

CCT SET



CARLO LED VERSIONS					
LAMP	POWER	LUMINOUS FLUX (Φ TOTAL) UP TO	VOLTAGE RANGE	CCT SETTABLE	
 GU10 LED	3,5W	366 lm	100-240V 50/60 Hz	4000K/2700K	=  35W HALOGEN
 GU10 LED	6W	615 lm	100-240V 50/60 Hz	4000K/2700K	=  50W HALOGEN

AVAILABLE COLORS			DIFFUSER
RESIN BODY (MOULDED COLOURS)			CLEAR (X)
BLACK (A)	GREY (L)	WHITE (W)	
			

CARLO WALL

LED
GU10 LAMP INCLUDED

CCT SET



CARLO WALL DECO

LED
GU10 LAMP INCLUDED

CCT SET



3,5W	DR1.570.U1K
6W	DR1.570.L1K
3,5W	DR3.570.U1K
6W	DR3.570.L1K

NEW VERSION
CCT SETTABLE LAMP

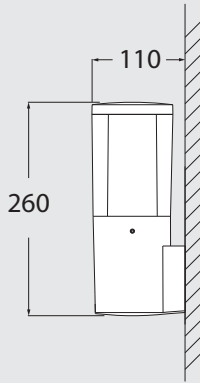

110
260

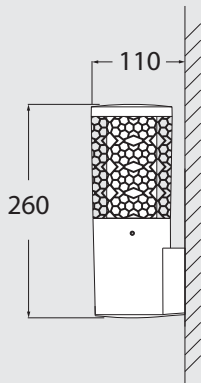

110
260

Master box: **20pcs** Master box: **20pcs**

CARLO-FS

LED
GU10 LAMP INCLUDED

CCT SET



CARLO-FS DECO

LED
GU10 LAMP INCLUDED

CCT SET



3,5W	DR1.571.U1K
6W	DR1.571.L1K
3,5W	DR3.571.U1K
6W	DR3.571.L1K

NEW VERSION
CCT SETTABLE LAMP



170
340



170
340

Master box: **20pcs** Master box: **20pcs**

AMELIA

BOLLARD RANGE



MADE IN ITALY

NEW CCT SET **NEW**

8,5W	11W
920 lm	1200 lm
2700 K	4000 K 6500 K





More details at page 95







DR2.575

CCT SETTABLE **NEW**

SDCM < 6

AMELIA CCT LED VERSIONS NEW					
LAMP	POWER	LUMINOUS FLUX UP TO	VOLTAGE RANGE	COLOUR TEMPERATURE	
 CCT SET LED E27	8,5W	920 lm	100-240V 50/60 Hz	6500K/4000K/2700K	=  60W INCANDESCENT
 CCT SET LED E27	11W	1200 lm	100-240V 50/60 Hz	6500K/4000K/2700K	=  75W INCANDESCENT

AVAILABLE COLORS			
RESIN BODY (MOULDED COLOURS)			DIFFUSER
BLACK (A)	GREY (L)	WHITE (W)	OPAL (Y)
			

AMELIA 800

LED
E27 LAMP INCLUDED

8,5W **CCT SET** DR2.575.V1K
NEW

11W **CCT SET** DR2.575.T1K

NEW VERSION CCT SETTABLE LAMP



Master box: **6pcs**

AMELIA 400

LED
E27 LAMP INCLUDED

8,5W **CCT SET** DR2.574.V1K
NEW

11W **CCT SET** DR2.574.T1K

NEW VERSION CCT SETTABLE LAMP



Master box: **12pcs**

AMELIA 250

LED
E27 LAMP INCLUDED

8,5W **CCT SET** DR2.573.V1K
NEW

11W **CCT SET** DR2.573.T1K

NEW VERSION CCT SETTABLE LAMP



Master box: **20pcs**

AMELIA SPIKE

LED
E27 LAMP INCLUDED

8,5W **CCT SET** DR2.572.V1K
NEW

11W **CCT SET** DR2.572.T1K

NEW VERSION CCT SETTABLE LAMP

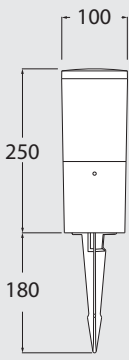
Master box: **20pcs**

AMELIA

WALL LAMP RANGE



MADE IN ITALY

NEW CCT SET **NEW**

8,5W	11W
920 lm	1200 lm
2700 K	4000 K 6500 K





More details at page 95







DR2.570

CCT SETTABLE **NEW**

SDCM <6



AMELIA CCT LED VERSIONS NEW					
LAMP	POWER	LUMINOUS FLUX UP TO	VOLTAGE RANGE	COLOUR TEMPERATURE	
	8,5W	920 lm	100-240V 50/60 Hz	6500K/4000K/2700K	=  60W INCANDESCENT
	11W	1200 lm	100-240V 50/60 Hz	6500K/4000K/2700K	=  75W INCANDESCENT

AVAILABLE COLORS			DIFFUSER
RESIN BODY <small>(MOULDED COLOURS)</small>			OPAL (Y)
BLACK (A)	GREY (L)	WHITE (W)	
			

AMELIA WALL



LED
E27 LAMP
INCLUDED

8,5W		DR2.570.V1K	NEW
11W		DR2.570.T1K	NEW

**NEW VERSION
CCT SETTABLE LAMP**

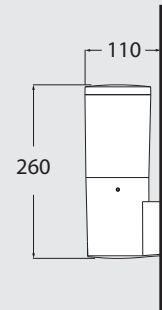

Master box: **20pcs**

AMELIA-FS



LED
E27 LAMP
INCLUDED

8,5W		DR2.571.V1K	NEW
11W		DR2.571.T1K	NEW

**NEW VERSION
CCT SETTABLE LAMP**

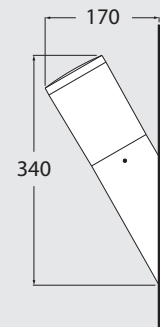

Master box: **20pcs**

ESTER

BOLLARD RANGE



MADE IN ITALY









DS1.564







CCT SETTABLE

3000 K 4000 K 6500 K

SDCM <6

ESTER LED VERSIONS					
LAMP	POWER	LUMINOUS FLUX (Φ TOTAL)	VOLTAGE RANGE	CCT SETTABLE	
 GX53	3W	410 lm	100-240V 50/60 Hz	6500K/4000K/3000K	=  40W INCANDESCENT
 GX53	7W	975 lm	100-240V 50/60 Hz	6500K/4000K/3000K	=  75W INCANDESCENT
 GX53	10W	1290 lm	100-240V 50/60 Hz	6500K/4000K/3000K	=  100W INCANDESCENT

AVAILABLE COLORS			
RESIN BODY + STEPPED REFLECTOR (MOULDED COLOURS)			DIFFUSER
BLACK (A)	GREY (L)	WHITE (W)	CLEAR (X)
			

ESTER 800



LED GX53 LAMP INCLUDED CCT SET	3W	DS1.564.G1K
	7W	DS1.564.C1K
	10W	DS1.564.D1K



Master box: 6pcs

ESTER 500



LED GX53 LAMP INCLUDED CCT SET	3W	DS1.563.G1K
	7W	DS1.563.C1K
	10W	DS1.563.D1K



Master box: 12pcs

ESTER WALL



LED GX53 LAMP INCLUDED CCT SET	3W	DS1.560.G1K
	7W	DS1.560.C1K
	10W	DS1.560.D1K



Master box: 18pcs

ESTER SPIKE



LED GX53 LAMP INCLUDED CCT SET	3W	DS1.561.G1K
	7W	DS1.561.C1K
	10W	DS1.561.D1K



Master box: 18pcs

ELISA

BOLLARD RANGE



MADE IN ITALY













DS2.564

CCT SETTABLE

3000 K 4000 K 6500 K

SDCM <6

ELISA LED VERSIONS					
LAMP	POWER	LUMINOUS FLUX (Φ TOTAL)	VOLTAGE RANGE	CCT SETTABLE	
 GX53	3W	410 lm	100-240V 50/60 Hz	6500K/4000K/3000K	=  40W INCANDESCENT
 GX53	7W	975 lm	100-240V 50/60 Hz	6500K/4000K/3000K	=  75W INCANDESCENT
 GX53	10W	1290 lm	100-240V 50/60 Hz	6500K/4000K/3000K	=  100W INCANDESCENT

AVAILABLE COLORS			
RESIN BODY (MOULDED COLOURS)			DIFFUSER
 BLACK (A)	 GREY (L)	 WHITE (W)	 CLEAR (X)
WITH WHITE RESIN REFLECTOR			

ELISA 800

 LED GX53 LAMP INCLUDED  CCT SET	3W	DS2.564.G1K
	7W	DS2.564.C1K
	10W	DS2.564.D1K



NEW VERSION CCT SETTABLE LAMP Master box: **6pcs**

ELISA 500

 LED GX53 LAMP INCLUDED  CCT SET	3W	DS2.563.G1K
	7W	DS2.563.C1K
	10W	DS2.563.D1K



NEW VERSION CCT SETTABLE LAMP Master box: **12pcs**



ELISA WALL

 LED GX53 LAMP INCLUDED  CCT SET	3W	DS2.560.G1K
	7W	DS2.560.C1K
	10W	DS2.560.D1K



NEW VERSION CCT SETTABLE LAMP Master box: **18pcs**

ELISA SPIKE

 LED GX53 LAMP INCLUDED  CCT SET	3W	DS2.561.G1K
	7W	DS2.561.C1K
	10W	DS2.561.D1K

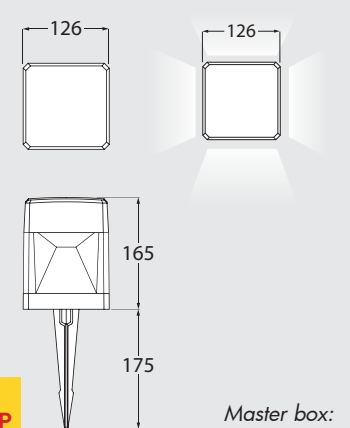
NEW VERSION CCT SETTABLE LAMP Master box: **18pcs**

GABRI-MINIGABRI REMI/LUCIA

BOLLARD



MADE IN ITALY



1R3.613.X10

NEW





CCT SETTABLE





2700 K 4000 K 6500 K



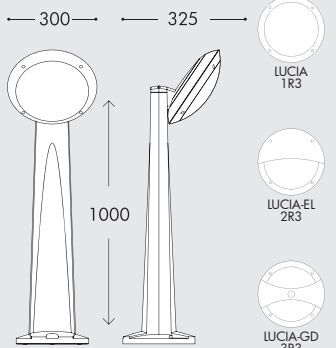

SDCM <6



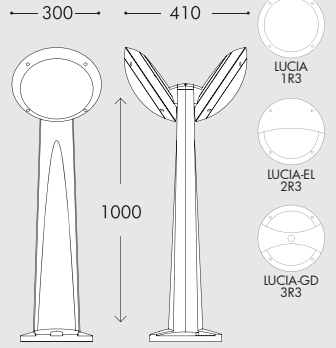

LED BULKHEAD GX53				
LAMP	POWER	LUMINOUS FLUX (Φ TOTAL)	VOLTAGE RANGE	CCT SETTABLE
	7W	790 lm	100-240V 50/60 Hz	6500K/4000K/2700K
	11W	1325 lm	100-240V 50/60 Hz	6500K/4000K/2700K
	18W	2118 lm	100-240V 50/60 Hz	6500K/4000K/2700K



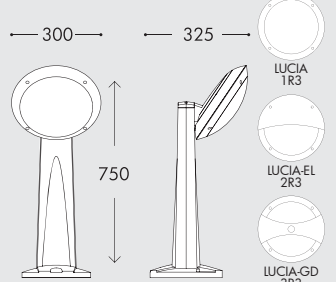

NEW

AVAILABLE COLORS		
RESIN BODY (MOULDED COLOURS)		DIFFUSER
BLACK (A)	GREY (L)	WHITE (W)
		
		OPAL (Y)
		

GABRI REMI/LUCIA 1L					
	 <p>300 325 1000</p> <p>LUCIA 1R3 LUCIA-EL 2R3 LUCIA-GD 3R3</p>				
		E27	1R3.613.X10.E27	2R3.613.X10.E27	3R3.613.X10.E27
		GX53 LED 7W CCT SET	1R3.613.X10.A1K	2R3.613.X10.A1K	3R3.613.X10.A1K
		GX53 LED 11W CCT SET	1R3.613.X10.B1K	2R3.613.X10.B1K	3R3.613.X10.B1K
		GX53 LED 18W CCT SET	1R3.613.X10.E1K	2R3.613.X10.E1K	3R3.613.X10.E1K

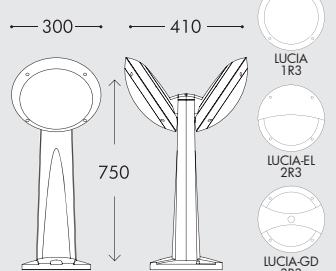
GABRI REMI/LUCIA 2L					
	 <p>300 410 1000</p> <p>LUCIA 1R3 LUCIA-EL 2R3 LUCIA-GD 3R3</p>				
		E27	1R3.613.X20.E27	2R3.613.X20.E27	3R3.613.X20.E27
		GX53 LED 7W CCT SET	1R3.613.X20.A1K	2R3.613.X20.A1K	3R3.613.X20.A1K
		GX53 LED 11W CCT SET	1R3.613.X20.B1K	2R3.613.X20.B1K	3R3.613.X20.B1K
		GX53 LED 18W CCT SET	1R3.613.X20.E1K	2R3.613.X20.E1K	3R3.613.X20.E1K

MINIGABRI REMI/LUCIA 1L					
	 <p>300 325 750</p> <p>LUCIA 1R3 LUCIA-EL 2R3 LUCIA-GD 3R3</p>				
		E27	1R3.612.X10.E27	2R3.612.X10.E27	3R3.612.X10.E27
		GX53 LED 7W CCT SET	1R3.612.X10.A1K	2R3.612.X10.A1K	3R3.612.X10.A1K
		GX53 LED 11W CCT SET	1R3.612.X10.B1K	2R3.612.X10.B1K	3R3.612.X10.B1K
		GX53 LED 18W CCT SET	1R3.612.X10.E1K	2R3.612.X10.E1K	3R3.612.X10.E1K

MINIGABRI REMI/LUCIA 2L					
	 <p>300 410 750</p> <p>LUCIA 1R3 LUCIA-EL 2R3 LUCIA-GD 3R3</p>				
		E27	1R3.612.X20.E27	2R3.612.X20.E27	3R3.612.X20.E27
		GX53 LED 7W CCT SET	1R3.612.X20.A1K	2R3.612.X20.A1K	3R3.612.X20.A1K
		GX53 LED 11W CCT SET	1R3.612.X20.B1K	2R3.612.X20.B1K	3R3.612.X20.B1K
		GX53 LED 18W CCT SET	1R3.612.X20.E1K	2R3.612.X20.E1K	3R3.612.X20.E1K

GABRI-MINIGABRI REMI/MADDI

BOLLARD



MADE IN ITALY



1V3.613.X10

NEW





CCT SETTABLE

2700 K 4000 K 6500 K

SDCM <6



LED BULKHEAD GX53				
LAMP	POWER	LUMINOUS FLUX (Φ TOTAL)	VOLTAGE RANGE	CCT SETTABLE
	7W	790 lm	100-240V 50/60 Hz	6500K/4000K/2700K
	11W	1325 lm	100-240V 50/60 Hz	6500K/4000K/2700K
	18W	2118 lm	100-240V 50/60 Hz	6500K/4000K/2700K

NEW

AVAILABLE COLORS		
RESIN BODY (MOULDED COLOURS)		DIFFUSER
BLACK (A)	GREY (L)	WHITE (W)
		
		OPAL (Y)
		

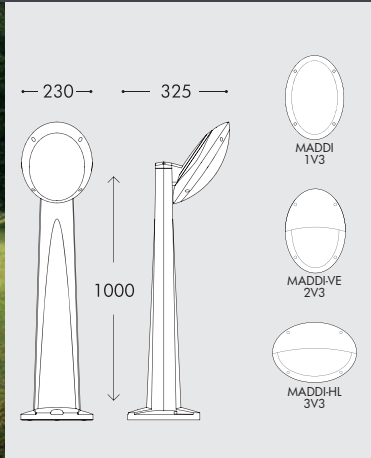

GABRI REMI/MADDI 1L



			
E27	1V3.613.X10.E27	2V3.613.X10.E27	3V3.613.X10.E27
GX53 LED 7W CCT SET	1V3.613.X10.A1K	2V3.613.X10.A1K	3V3.613.X10.A1K
GX53 LED 11W CCT SET	1V3.613.X10.B1K	2V3.613.X10.B1K	3V3.613.X10.B1K
GX53 LED 18W CCT SET	1V3.613.X10.E1K	2V3.613.X10.E1K	3V3.613.X10.E1K

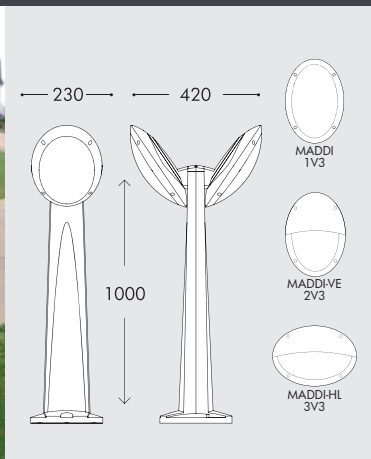

GABRI REMI/MADDI 2L



			
E27	1V3.613.X20.E27	2V3.613.X20.E27	3V3.613.X20.E27
GX53 LED 7W CCT SET	1V3.613.X20.A1K	2V3.613.X20.A1K	3V3.613.X20.A1K
GX53 LED 11W CCT SET	1V3.613.X20.B1K	2V3.613.X20.B1K	3V3.613.X20.B1K
GX53 LED 18W CCT SET	1V3.613.X20.E1K	2V3.613.X20.E1K	3V3.613.X20.E1K

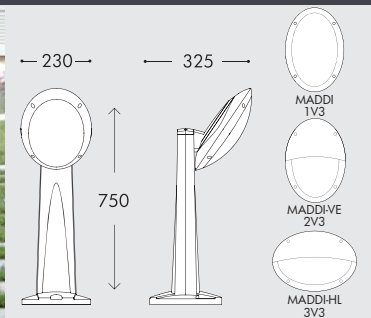

MINIGABRI REMI/MADDI 1L

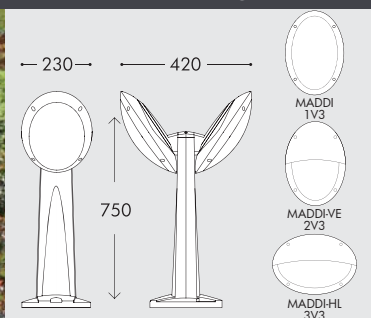

			
E27	1V3.612.X10.E27	2V3.612.X10.E27	3V3.612.X10.E27
GX53 LED 7W CCT SET	1V3.612.X10.A1K	2V3.612.X10.A1K	3V3.612.X10.A1K
GX53 LED 11W CCT SET	1V3.612.X10.B1K	2V3.612.X10.B1K	3V3.612.X10.B1K
GX53 LED 18W CCT SET	1V3.612.X10.E1K	2V3.612.X10.E1K	3V3.612.X10.E1K

MINIGABRI REMI/MADDI 2L



			
E27	1V3.612.X20.E27	2V3.612.X20.E27	3V3.612.X20.E27
GX53 LED 7W CCT SET	1V3.612.X20.A1K	2V3.612.X20.A1K	3V3.612.X20.A1K
GX53 LED 11W CCT SET	1V3.612.X20.B1K	2V3.612.X20.B1K	3V3.612.X20.B1K
GX53 LED 18W CCT SET	1V3.612.X20.E1K	2V3.612.X20.E1K	3V3.612.X20.E1K

PINELA-MINIPINELA

BOLLARD



MADE IN ITALY



2N1.613.010

CCT SETTABLE

 3000 K 4000 K 6500 K

SDCM <6



GERMANA LED VERSIONS					
LAMP	POWER	LUMINOUS FLUX (Φ TOTAL)	VOLTAGE RANGE	CCT SETTABLE	
2x GXS3	2x3W 6W	820 lm	100-240V 50/60 Hz	6500K /4000K /3000K	75W INCANDESCENT
2x GXS3	2x7W 14W	1950 lm	100-240V 50/60 Hz	6500K /4000K /3000K	100W INCANDESCENT
2x GXS3	2x10W 20W	2570 lm	100-240V 50/60 Hz	6500K /4000K /3000K	150W INCANDESCENT

AVAILABLE COLORS			DIFFUSER
RESIN BODY (MOULDED COLOURS)			
BLACK (A)	GREY (L)	WHITE (W)	OPAL (Y)

PINELA 1L

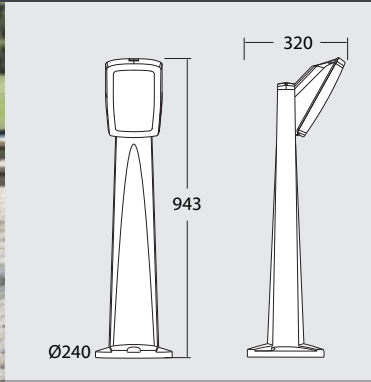

E27		2N1.613.010.P27
2x3W 6W		2N1.613.010.G2K
2x7W 14W		2N1.613.010.C2K
2x10W 20W		2N1.613.010.D2K

PINELA 2L

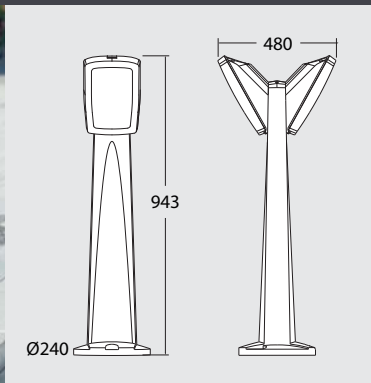

E27		2N1.613.020.P27
2x 6W		2N1.613.020.G2K
2x 14W		2N1.613.020.C2K
2x 20W		2N1.613.020.D2K

MINIPINELA 1L

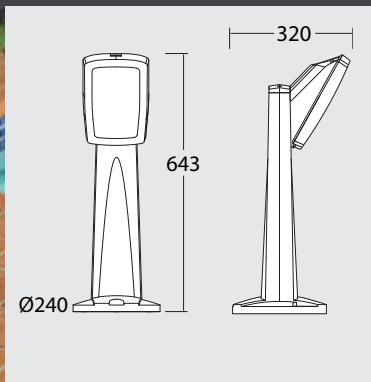

E27		2N1.612.010.P27
2x3W 6W		2N1.612.010.G2K
2x7W 14W		2N1.612.010.C2K
2x10W 20W		2N1.612.010.D2K

MINIPINELA 2L

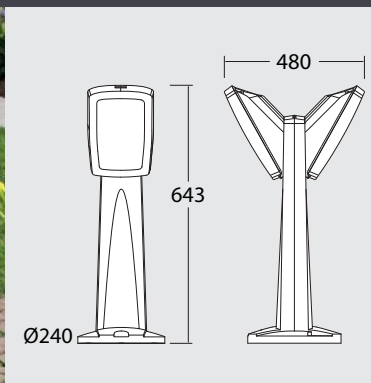

E27		2N1.612.020.P27
2x 6W		2N1.612.020.G2K
2x 14W		2N1.612.020.C2K
2x 20W		2N1.612.020.D2K

ABRAM RANGE

UP&DOWN



MADE IN ITALY









AB1.000.J1K

CCT SETTABLE

SDCM <6

2700 K 4000 K 6500 K

ADAM LED VERSIONS				
LAMP	POWER	LUMINOUS FLUX UP TO	VOLTAGE RANGE	CCT SETTABLE
 R7s LED	3,5W	365 lm	100-240V 50/60 Hz	6500K/4000K/2700K
 R7s LED	7,5W	790 lm	100-240V 50/60 Hz	6500K/4000K/2700K
 R7s LED	10,5W	1160 lm	100-240V 50/60 Hz	6500K/4000K/2700K

AVAILABLE COLORS			
RESIN BODY (MOULDED COLOURS)			DIFFUSER
BLACK (A)	GREY (L)	WHITE (W)	CLEAR (X)
			

ABRAM 150



CCT SET

LED R7s LAMP INCLUDED

3,5W

AB1.000.J1K

NEW VERSION CCT SETTABLE LAMP

up
365 lm

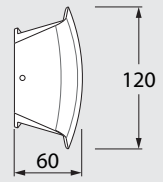
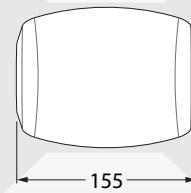

Master box: **30pcs**

ABRAM 190



CCT SET

LED R7s LAMP INCLUDED

7,5W

AB2.000.K1K

NEW VERSION CCT SETTABLE LAMP

up
790 lm

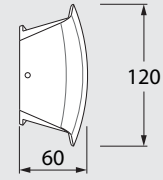
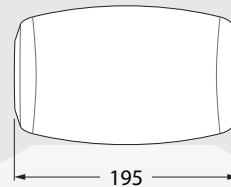

Master box: **30pcs**

ABRAM 270



CCT SET

LED R7s LAMP INCLUDED

10,5W

AB3.000.P1K

NEW VERSION CCT SETTABLE LAMP

up
1160 lm

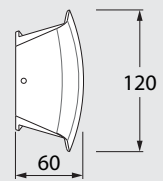
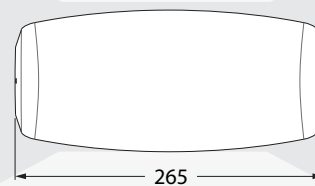

Master box: **14pcs**

FRANCA 90

UP&DOWN



3A7.002.U1K

CCT SETTABLE

2700 K 4000 K

SDCM < 3

FRANCA 90 LED VERSIONS					
LAMP	POWER	LUMINOUS FLUX (Φ TOTAL) UP TO	VOLTAGE RANGE	CCT SETTABLE	
FRANCA 90 1L	3,5W	366 lm	100-240V 50/60 Hz	4000K/2700K	= 35W HALOGEN
	6W	615 lm	100-240V 50/60 Hz	4000K/2700K	= 50W HALOGEN
FRANCA 90 2L	2X 2x 3,5W 7W	732 lm	100-240V 50/60 Hz	4000K/2700K	= 2 x 35W HALOGEN
	2X 2x 6W 12W	1230 lm	100-240V 50/60 Hz	4000K/2700K	= 2 x 50W HALOGEN

AVAILABLE COLORS	
COVER (MOULDED COLOURS)	DIFFUSER
<p>BLACK (A) GREY (L) WHITE (W)</p>	<p>FROSTED (X) BLUE (U)</p> <p>GREEN (N) ORANGE (R)</p>

FRANCA 90

	3,5W	3A7.000.U1K
	6W	3A7.000.L1K

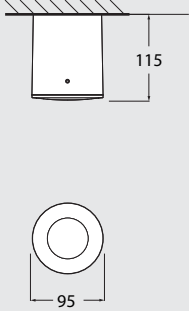
NEW VERSION CCT SETTABLE LAMP Master box: **30pcs**

FRANCA 90 SPIKE

	3,5W	3A7.001.U1K
	6W	3A7.001.L1K



NEW VERSION CCT SETTABLE LAMP Master box: **30pcs**

FRANCA 90-1L WALL

	3,5W	3A7.002.U1K
	6W	3A7.002.L1K



NEW VERSION CCT SETTABLE LAMP Master box: **30pcs**

FRANCA 90-2L WALL

	2x3,5W 7W	3A7.003.U2K
	2x6W 12W	3A7.003.L2K

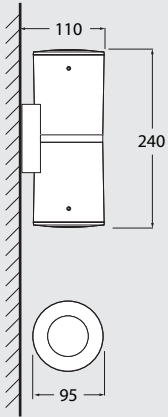
NEW VERSION CCT SETTABLE LAMP Master box: **20pcs**

MARTA 90

UP&DOWN



MADE IN ITALY

















1A4.000

CCT SETTABLE

SDCM < 3

2700 K 4000 K

MARTA 90 LED VERSIONS					
LAMP	POWER	LUMINOUS FLUX (Φ TOTAL) UP TO	VOLTAGE RANGE	CCT SETTABLE	
MARTA 90 1L	 3,5W	366 lm	100-240V 50/60 Hz	4000K/2700K	=  35W HALOGEN
	 6W	615 lm	100-240V 50/60 Hz	4000K/2700K	=  50W HALOGEN
MARTA 90 2L	2x  3,5W 7W	732 lm	100-240V 50/60 Hz	4000K/2700K	= 2 x  35W HALOGEN
	2x  6W 12W	1230 lm	100-240V 50/60 Hz	4000K/2700K	= 2 x  50W HALOGEN

AVAILABLE COLORS	
COVER	DIFFUSER
(MOULDED COLOURS)	
BLACK (A) GREY (L) WHITE (W)   	FROSTED (X) BLUE (U)   GREEN (N) ORANGE (R)  

MARTA90 1L



LED
GU10 LAMP
INCLUDED
CCT
SET

3,5W	1A4.000.U1K
6W	1A4.000.L1K

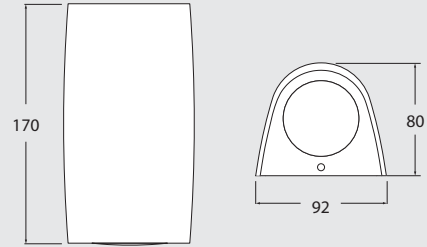

**NEW VERSION
CCT SETTABLE LAMP**

Master box: **36pcs**

MARTA90 2L



LED
GU10 LAMP
INCLUDED
CCT
SET

2x3,5W 7W	2A4.000.U2K
2x6W 12W	2A4.000.L2K

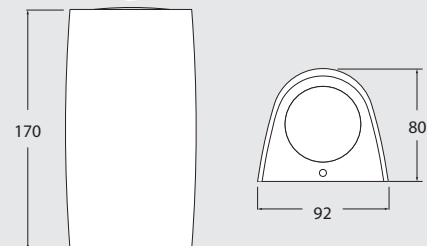

**NEW VERSION
CCT SETTABLE LAMP**

Master box: **36pcs**

MARTA 160

UP&DOWN











MADE IN ITALY









1A6.000

CCT SETTABLE

SDCM <6

MARTA160 LED VERSIONS					
LAMP	POWER	LUMINOUS FLUX (Φ TOTAL)	VOLTAGE RANGE	CCT SETTABLE	
MARTA160 1L 	3W	410 lm	100-240V 50/60 Hz	6500K/4000K/3000K	=  40W INCANDESCENT
	7W	975 lm	100-240V 50/60 Hz	6500K/4000K/3000K	=  75W INCANDESCENT
	10W	1290 lm	100-240V 50/60 Hz	6500K/4000K/3000K	=  100W INCANDESCENT
MARTA160 2L 	2x3W 6W	820 lm	100-240V 50/60 Hz	6500K/4000K/3000K	=  2x40W INCANDESCENT
	2x7W 14W	1950 lm	100-240V 50/60 Hz	6500K/4000K/3000K	=  2x75W INCANDESCENT
	2x10W 20W	2580 lm	100-240V 50/60 Hz	6500K/4000K/3000K	=  2x100W INCANDESCENT

AVAILABLE COLORS	
COVER	DIFFUSER
(MOULDED COLOURS)	
BLACK (A)  GREY (L)  WHITE (W) 	FROSTED (X)  BLUE (U)  GREEN (N)  ORANGE (R) 

MARTA160 1L



LED
GX53
LAMP
INCLUDED
CCT
SET

E27	1A6.000.E27
3W	1A6.000.G1K
7W	1A6.000.C1K
10W	1A6.000.D1K

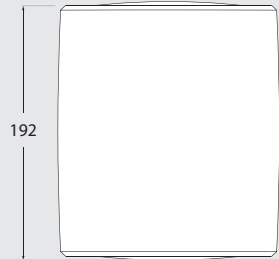
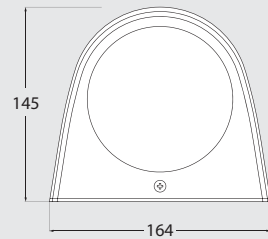

**NEW VERSION
CCT SETTABLE LAMP**

Master box: **18pcs**

MARTA160 2L



LED
GX53
LAMP
INCLUDED
CCT
SET

2x3W 6W	2A6.000.G2K
2x7W 14W	2A6.000.C2K
2x10W 20W	2A6.000.D2K

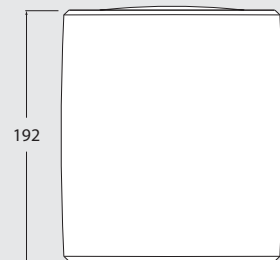
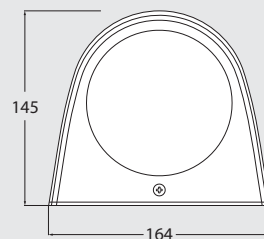

**NEW VERSION
CCT SETTABLE LAMP**

Master box: **18pcs**

MADE IN ITALY

NEW CCT SET **NEW**

6,5W 800 lm 2700 K	8,5W 920 lm 2700 K	11W 1200 lm 2700 K
	4000 K	6500 K

More details at page 95



1A1.000.F1R

FRANCY LED VERSIONS

LAMP	POWER	LUMINOUS FLUX UP TO	VOLTAGE RANGE	COLOUR TEMPERATURE	
FILAMENT LED E27	6,5W	800 lm	100-240V 50/60 Hz	2700K	= 60W INCANDESCENT
CCT SET LED E27	8,5W	920 lm	100-240V 50/60 Hz	6500K/4000K/2700K	= 60W INCANDESCENT
2x G6.5 LED	2x3W 6W	820 lm (Ø TOTAL)	100-240V 50/60 Hz	6500K/4000K/3000K	= 75W INCANDESCENT

NEW

AVAILABLE COLORS

RESIN BODY (MOULDED COLOURS)			DIFFUSER
BLACK (A)	GREY (L)	WHITE (W)	OPAL (Y)

FRANCY

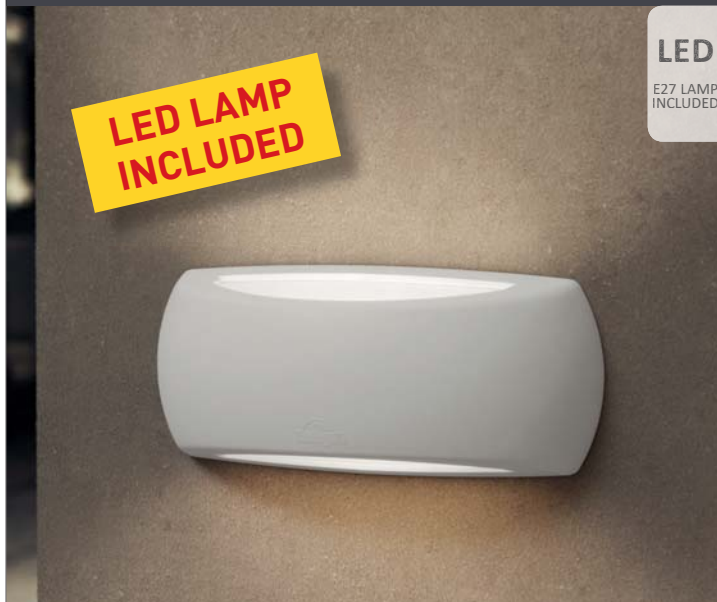

LED

E27 LAMP INCLUDED

6,5W FILAMENT LED	2700K	1A1.000.F1R	
8,5W	CCT SET	1A1.000.V1K	NEW

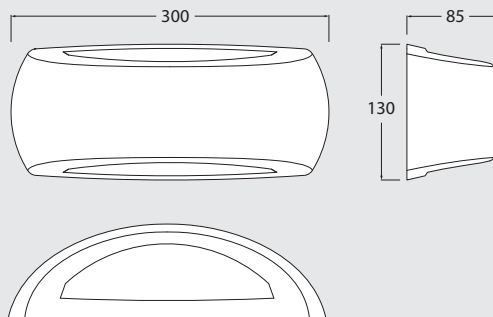

AVAILABLE VERSIONS SUPPLIED FULLY PRE-WIRED

FILAMENT LED

CCT LED



WITH SENSOR)))
220-240V
6W (.S1R)
8,5W (.VSK)

Master box: **24pcs**

FRANCY-OP



LED

LAMP INCLUDED

E27		2A1.000.E27	
6,5W FILAMENT LED	2700K	2A1.000.F1R	
2x3W 6W	CCT SET	2A1.000.G2K	
E27 WITH SENSOR))) 220-240V		2A1.000.ES7	

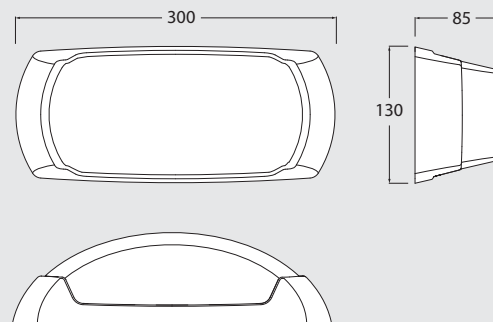

AVAILABLE VERSIONS SUPPLIED FULLY PRE-WIRED

E27



Master box: **24pcs**

MINITOMMY

FLOODLIGHT





MADE IN ITALY



1M1.001

CCT SETTABLE

 **2700 K** **4000 K**

SDCM < 3 

MINITOMMY LED VERSIONS					
LAMP	POWER	LUMINOUS FLUX (Φ TOTAL) UP TO	VOLTAGE RANGE	CCT SETTABLE	
MINITOMMY 1L GU10 LED	3,5W	366 lm	100-240V 50/60 Hz	4000K/2700K	= 35W HALOGEN
GU10 LED	6W	615 lm	100-240V 50/60 Hz	4000K/2700K	= 50W HALOGEN
MINITOMMY 2L 2x GU10 LED	2x 3,5W 7W	732 lm	100-240V 50/60 Hz	4000K/2700K	= 2 x 35W HALOGEN
2x GU10 LED	2x 6W 12W	1230 lm	100-240V 50/60 Hz	4000K/2700K	= 2 x 50W HALOGEN

AVAILABLE COLORS	
COVER (MOULDED COLOURS)	DIFFUSER
BLACK (A) GREY (L) WHITE (W)	FROSTED (X) BLUE (U) GREEN (N) ORANGE (R)



LED
GU10 LAMP
INCLUDED
CCT
SET

**NEW VERSION
CCT SETTABLE LAMP**

MINITOMMY	
3,5W	1M1.000.U1K
6W	1M1.000.L1K

Master box: **30pcs**

MINITOMMY SPIKE	
3,5W	1M1.001.U1K
6W	1M1.001.L1K

Master box: **30pcs**



LED
GU10 LAMP
INCLUDED
CCT
SET

**NEW VERSION
CCT SETTABLE LAMP**

MINITOMMY-EL	
3,5W	1M2.000.U1K
6W	1M2.000.L1K

Master box: **30pcs**

MINITOMMY-EL SPIKE	
3,5W	1M2.001.U1K
6W	1M2.001.L1K

Master box: **30pcs**



LED
GU10 LAMP
INCLUDED
CCT
SET

**NEW VERSION
CCT SETTABLE LAMP**

MINITOMMY 2L	
2x 3,5W	3M1.000.U2K
2x 6W	3M1.000.L2K

Master box: **18pcs**

MINITOMMY 2L SPIKE	
2x 3,5W	3M1.001.U2K
2x 6W	3M1.001.L2K

Master box: **18pcs**



LED
GU10 LAMP
INCLUDED
CCT
SET

**NEW VERSION
CCT SETTABLE LAMP**

MINITOMMY-EL 2L	
2x 3,5W	3M2.000.U2K
2x 6W	3M2.000.L2K

Master box: **18pcs**

MINITOMMY-EL 2L SPIKE	
2x 3,5W	3M2.001.U2K
2x 6W	3M2.001.L2K

Master box: **18pcs**

TOMMY

FLOODLIGHT



MADE IN ITALY



UV-TREATED



ANTI-SHOCK



RECYCLABLE



CE



IP66





DOUBLE INSULATION CLASS



2M1.000

CCT SETTABLE

 **3000 K**  **4000 K**  **6500 K**

SDCM <6



TOMMY LED VERSIONS					
LAMP	POWER	LUMINOUS FLUX (Φ TOTAL)	VOLTAGE RANGE	CCT SETTABLE	
GX53	3W	410 lm	100-240V 50/60 Hz	6500K/4000K/3000K	40W INCANDESCENT
GX53	7W	975 lm	100-240V 50/60 Hz	6500K/4000K/3000K	75W INCANDESCENT
GX53	10W	1290 lm	100-240V 50/60 Hz	6500K/4000K/3000K	100W INCANDESCENT

AVAILABLE COLORS		
COVER (MOULDED COLOURS)		DIFFUSER
BLACK (A)	GREY (L)	FROSTED (X)
WHITE (W)		BLUE (U)
		GREEN (N)
		ORANGE (R)

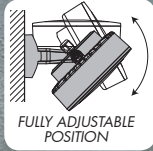

LED
GX53 LAMP INCLUDED
CCT SET

TOMMY-SQ	
3W	5M1.000.G1K
7W	5M1.000.C1K
10W	5M1.000.D1K

TOMMY-SQ SPIKE	
3W	5M1.001.G1K
7W	5M1.001.C1K
10W	5M1.001.D1K

NEW VERSION
CCT SETTABLE LAMP

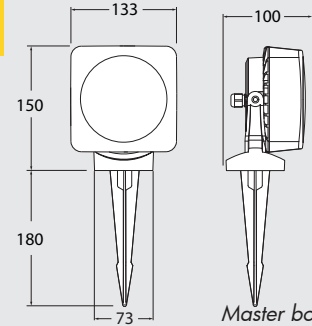
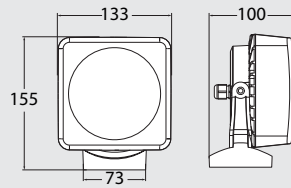

Master box: **18pcs**

Master box: **18pcs**

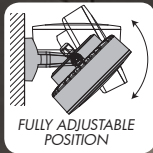

LED
GX53 LAMP INCLUDED
CCT SET

TOMMY	
3W	2M1.000.G1K
7W	2M1.000.C1K
10W	2M1.000.D1K

TOMMY SPIKE	
3W	2M1.001.G1K
7W	2M1.001.C1K
10W	2M1.001.D1K

NEW VERSION
CCT SETTABLE LAMP

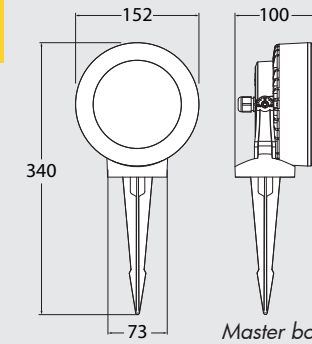
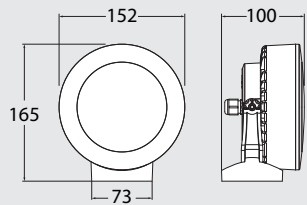

Master box: **18pcs**

Master box: **18pcs**



LED
GX53 LAMP INCLUDED
CCT SET

TOMMY-EL	
3W	2M2.000.G1K
7W	2M2.000.C1K
10W	2M2.000.D1K

TOMMY-EL SPIKE	
3W	2M2.001.G1K
7W	2M2.001.C1K
10W	2M2.001.D1K

NEW VERSION
CCT SETTABLE LAMP

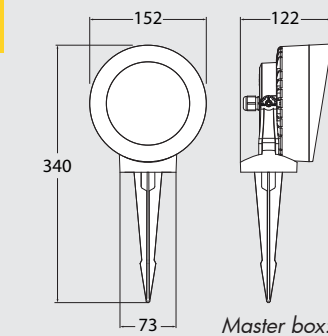
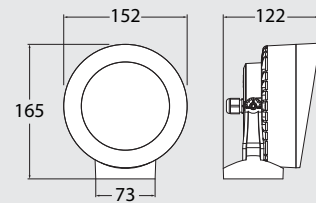

Master box: **18pcs**

Master box: **18pcs**

TOMMY 2L

FLOODLIGHT



4M1.001



CCT SETTABLE

3000 K 4000 K 6500 K

SDCM <6

TOMMY-2L LED VERSIONS					
LAMP	POWER	LUMINOUS FLUX (Φ TOTAL)	VOLTAGE RANGE	CCT SETTABLE	
2x GX53	2x3W 6W	820 lm	100-240V 50/60 Hz	6500K/4000K/3000K	= 75W INCANDESCENT
2x GX53	2x7W 14W	1950 lm	100-240V 50/60 Hz	6500K/4000K/3000K	= 100W INCANDESCENT
2x GX53	2x10W 20W	2580 lm	100-240V 50/60 Hz	6500K/4000K/3000K	= 150W INCANDESCENT

AVAILABLE COLORS					
COVER (MOULDED COLOURS)			DIFFUSER		
BLACK (A)	GREY (L)	WHITE (W)	FROSTED (X)	BLUE (U)	
			GREEN (N)	ORANGE (R)	



TOMMY-SQ 2L	
2x 3W	6M1.000.G2K
2x 7W	6M1.000.C2K
2x 10W	6M1.000.D2K

TOMMY-SQ 2L SPIKE	
2x 3W	6M1.001.G2K
2x 7W	6M1.001.C2K
2x 10W	6M1.001.D2K

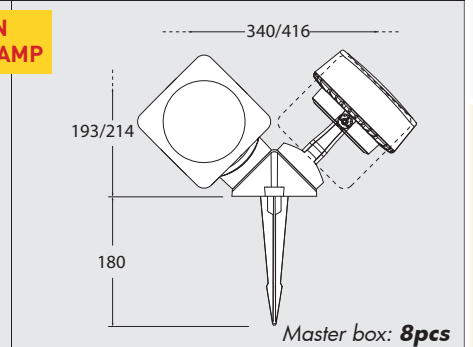
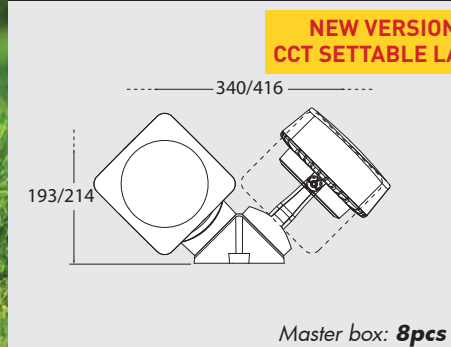

TOMMY 2L	
2x 3W	4M1.000.G2K
2x 7W	4M1.000.C2K
2x 10W	4M1.000.D2K

TOMMY 2L SPIKE	
2x 3W	4M1.001.G2K
2x 7W	4M1.001.C2K
2x 10W	4M1.001.D2K

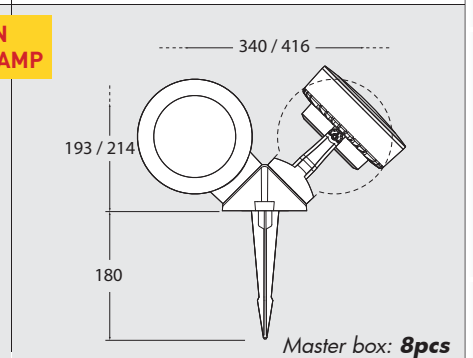
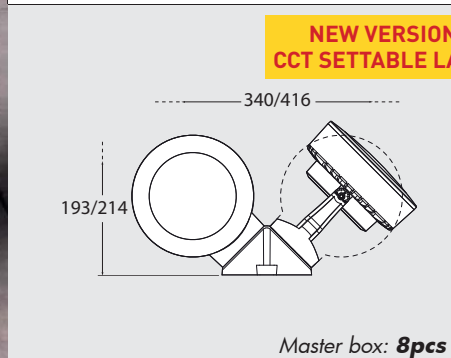

TOMMY-EL 2L	
2x 3W	4M2.000.G2K
2x 7W	4M2.000.C2K
2x 10W	4M2.000.D2K

TOMMY-EL 2L SPIKE	
2x 3W	4M2.001.G2K
2x 7W	4M2.001.C2K
2x 10W	4M2.001.D2K

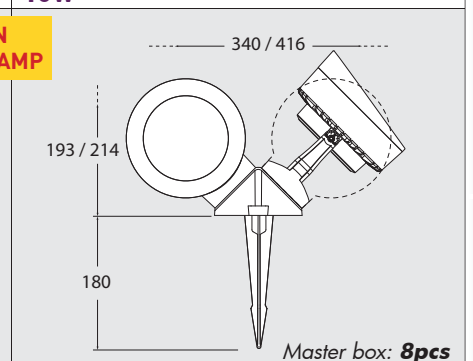
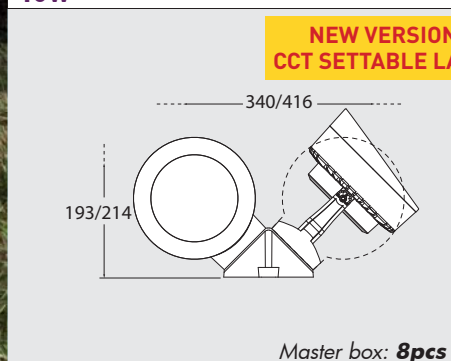

GERMANA FLOODLIGHT



MADE IN ITALY

- UV-TREATED
- ANTI-SHOCK
- RECYCLABLE
- CE
- CB IEC60730 SCHEME
- IP66
- DOUBLE INSULATION CLASS

2N1.000



CCT SETTABLE

3000 K
4000 K
6500 K

SDCM <6

SUPPLIED FULLY PRE-WIRED

2x GX53 LED	E27	E27 + SENSOR
		<p>WITH SENSOR))) 220-240V (.PS7)</p>

GERMANA LED VERSIONS					
LAMP	POWER	LUMINOUS FLUX (Φ TOTAL)	VOLTAGE RANGE	CCT SETTABLE	
2x GX53	2x3W 6W	820 lm	100-240V 50/60 Hz	6500K/4000K/3000K	= 75W INCANDESCENT
2x GX53	2x7W 14W	1950 lm	100-240V 50/60 Hz	6500K/4000K/3000K	= 100W INCANDESCENT
2x GX53	2x10W 20W	2580 lm	100-240V 50/60 Hz	6500K/4000K/3000K	= 150W INCANDESCENT

AVAILABLE COLORS		
RESIN BODY (MOULDED COLOURS)		DIFFUSER
BLACK (A)	GREY (L)	WHITE (W)
OPAL (Y)		

GERMANA



LED
GX53
LAMP
INCLUDED

**CCT
SET**

E27	2N1.000.P27
2x3W 6W	2N1.000.G2K
2x7W 14W	2N1.000.C2K
2x10W 20W	2N1.000.D2K



Master box: 18pcs

**NEW VERSION
CCT SETTABLE LAMP**

GIOVA/GERMANA



LED
GX53
LAMP
INCLUDED

**CCT
SET**

E27	2N1.702.P27
2x3W 6W	2N1.702.G2K
2x7W 14W	2N1.702.C2K
2x10W 20W	2N1.702.D2K



Master box: 18pcs

**NEW VERSION
CCT SETTABLE LAMP**

MADE IN ITALY













4P2.000

SUPPLIED FULLY PRE-WIRED

GX53 LED	GX53 LED + SENSOR	4x GX53 LED	2x E27	2x E27 + SENSOR
	 <p>WITH SENSOR))) (220-240V)</p> <p>7W CCT (.ASK) 11W CCT (.BSK) 18W CCT (.ESK)</p>			 <p>WITH SENSOR))) 220-240V (.ES8)</p>

NEW

GIUSEPPE LED VERSIONS					
LAMP	POWER	LUMINOUS FLUX (Φ TOTAL)	VOLTAGE RANGE	CCT SETTABLE	
	7W	790 lm	100-240V 50/60 Hz	6500K/4000K/2700K	 60W INCANDESCENT
	11W	1325 lm	100-240V 50/60 Hz	6500K/4000K/2700K	 100W INCANDESCENT
	18W	2118 lm	100-240V 50/60 Hz	6500K/4000K/2700K	 150W INCANDESCENT
	4x7W 28W	3900 lm	100-240V 50/60 Hz	6500K/4000K/3000K	 70W HQI-SON
	4x10W 40W	5160 lm	100-240V 50/60 Hz	6500K/4000K/3000K	 100W HQI-SON

AVAILABLE COLORS			DIFFUSER
RESIN BODY (MOULDED COLOURS)			
 BLACK (A)	 GREY (L)	 WHITE (W)	 OPAL (Y)

16

BOLLARD

GIUSEPPE



LED
GX53 LAMP INCLUDED

CCT SET

2x E27	4P2.000.E28
7W	4P1.000.A1K
11W	4P1.000.B1K
18W	4P1.000.E1K
4x7W 28W	4P2.000.C4K
4x10W 40W	4P2.000.D4K





Master box: 10pcs

34

UP&DOWN

44

FLOODLIGHT

54

IN-GROUND

60

BRICKLIGHT

GIOVA/GIUSEPPE



LED
GX53 LAMP INCLUDED

CCT SET

2x E27	4P2.702.E28
7W	4P1.702.A1K
11W	4P1.702.B1K
18W	4P1.702.E1K
4x7W 28W	4P2.702.C4K
4x10W 40W	4P2.702.D4K





Master box: 10pcs

70

BULKHEAD

88

POST

92

LAMPS



111.000.Z1L

IN GROUND INSTALLATION



WALL RECESSED INSTALLATION

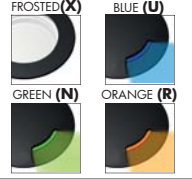

ALDO LED VERSIONS				
LAMP	LUMINOUS FLUX UP TO	LUMINOUS FLUX	VOLTAGE RANGE	COLOUR TEMPERATURE
	1,7W	150 lm	100-240V 50/60 Hz	4000K
				3000K

AVAILABLE COLORS	
COVER (MOULDED COLOURS)	DIFFUSER
<p>BLACK (A) GREY (L) WHITE (W)</p> 	<p>FROSTED (X) BLUE (U) GREEN (N) ORANGE (R)</p> 

ALDO

		1,7W 4000K 1L0.000.Z1L		
		3000K 1L0.000.Z1R		

LED G9 LAMP INCLUDED

Master box: 75pcs

ALDO 1L

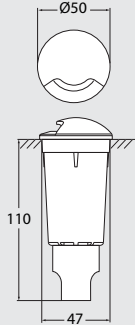
		1,7W 4000K 1L1.000.Z1L		
		3000K 1L1.000.Z1R		

LED G9 LAMP INCLUDED

Master box: 75pcs

ALDO 2L

		1,7W 4000K 1L2.000.Z1L		
		3000K 1L2.000.Z1R		

LED G9 LAMP INCLUDED

Master box: 75pcs

ALDO SQUARE

		1,7W 4000K 1L4.000.Z1L		
		3000K 1L4.000.Z1R		

LED G9 LAMP INCLUDED

Master box: 75pcs

CECI
IN-GROUND

fumagalli
since 1973

MADE IN ITALY













1F2.000

CCT SETTABLE

SDCM <3

2700 K 4000 K

CECI 90 LED VERSIONS					
LAMP	POWER	LUMINOUS FLUX (Φ TOTAL) UP TO	VOLTAGE RANGE	CCT SETTABLE	
 GU10 LED	3,5W	366 lm	100-240V 50/60 Hz	4000K/2700K	=  35W HALOGEN
 GU10 LED	6W	615 lm	100-240V 50/60 Hz	4000K/2700K	=  50W HALOGEN

AVAILABLE COLORS	
COVER (MOULDED COLOURS)	DIFFUSER
 BLACK (A)  GREY (L)  WHITE (W)	 FROSTED (X)  BLUE (U)  GREEN (N)  ORANGE (R)

CECI 90



LED
GU10 LAMP INCLUDED

CCT SET

**NEW VERSION
CCT SETTABLE LAMP**

3,5W	1F1.000.U1K
6W	1F1.000.L1K



Master box: **40pcs**

CECI 90-2L



LED
GU10 LAMP INCLUDED

CCT SET

**NEW VERSION
CCT SETTABLE LAMP**

3,5W	1F2.000.U1K
6W	1F2.000.L1K



Master box: **40pcs**

CECI 90-3L



LED
GU10 LAMP INCLUDED

CCT SET

**NEW VERSION
CCT SETTABLE LAMP**

3,5W	1F3.000.U1K
6W	1F3.000.L1K

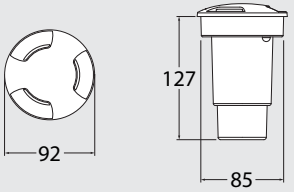

Master box: **40pcs**

CECI 90-SQ



LED
GU10 LAMP INCLUDED



CCT SET







**NEW VERSION
CCT SETTABLE LAMP**



3,5W	1F4.000.U1K
6W	1F4.000.L1K



Master box: **40pcs**

AVAILABLE COLORS	
COVER (MOULDED COLOURS)	DIFFUSER
<p>BLACK (A) GREY (L)</p> 	<p>FROSTED (X)</p> <p>BLUE (U) GREEN (N) ORANGE (R)</p> 

CECI 120 LED VERSIONS					
LAMP	POWER	LUMINOUS FLUX (Φ TOTAL)	VOLTAGE RANGE	CCT SETTABLE	
	3W	410 lm	100-240V 50/60 Hz	6500K/4000K/3000K	

CECI 120

		3W	2F1.000.G1K
---	---	-----------	-------------



NEW VERSION CCT SETTABLE LAMP

Master box: **36pcs**

CECI 120-2L

		3W	2F2.000.G1K
---	---	-----------	-------------



NEW VERSION CCT SETTABLE LAMP

Master box: **36pcs**

CECI 120-3L

		3W	2F3.000.G1K
---	---	-----------	-------------



NEW VERSION CCT SETTABLE LAMP

Master box: **36pcs**

CECI 120-SQ

		3W	2F4.000.G1K
---	---	-----------	-------------



NEW VERSION CCT SETTABLE LAMP

Master box: **36pcs**



CECI 160 LED VERSIONS					
LAMP	POWER	LUMINOUS FLUX (Φ TOTAL)	VOLTAGE RANGE	CCT SETTABLE	
GX53	7W	975 lm	100-240V 50/60 Hz	6500K/4000K/3000K	= 75W INCANDESCENT
GX53	10W	1290 lm	100-240V 50/60 Hz	6500K/4000K/3000K	= 100W INCANDESCENT

CECI 160

LED
GX53 LAMP INCLUDED

CCT SET

7W	3F1.000.C1K
10W	3F1.000.D1K

160

111

147

NEW VERSION CCT SETTABLE LAMP

Master box: 18pcs

CECI 160-2L

LED
GX53 LAMP INCLUDED

CCT SET

7W	3F2.000.C1K
10W	3F2.000.D1K

160

111

147

NEW VERSION CCT SETTABLE LAMP

Master box: 18pcs

CECI 160-3L

LED
GX53 LAMP INCLUDED

CCT SET

7W	3F3.000.C1K
10W	3F3.000.D1K

160

111

147

NEW VERSION CCT SETTABLE LAMP

Master box: 18pcs

CECI 160-SQ

LED
GX53 LAMP INCLUDED

CCT SET

7W	3F4.000.C1K
10W	3F4.000.D1K

160

111

147

NEW VERSION CCT SETTABLE LAMP

Master box: 18pcs

NINA RANGE



RECESSED







6C1.000.J1K

CCT SETTABLE

SDCM <6

NINA LED VERSIONS				
LAMP	POWER	LUMINOUS FLUX UP TO	VOLTAGE RANGE	CCT SETTABLE
 R7s LED	3,5W	365 lm	100-240V 50/60 Hz	6500K/4000K/2700K
 R7s LED	7,5W	790 lm	100-240V 50/60 Hz	6500K/4000K/2700K
 R7s LED	10,5W	1160 lm	100-240V 50/60 Hz	6500K/4000K/2700K

AVAILABLE COLORS			DIFFUSER
RESIN BODY (MOULDED COLOURS)			
BLACK (A)	GREY (L)	WHITE (W)	OPAL (Y)
			

NINA 150



**NEW VERSION
CCT SETTABLE LAMP**

**up
365
lm**

CCT SET

LED
R7s
LAMP
INCLUDED

3,5W

6C1.000.J1K

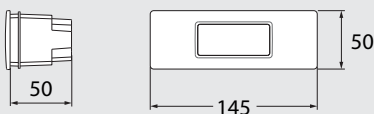

Master box: 50pcs

NINA 190



**NEW VERSION
CCT SETTABLE LAMP**

**up
790
lm**

CCT SET

LED
R7s
LAMP
INCLUDED

7,5W

7C1.000.K1K

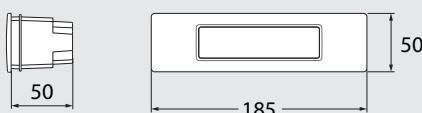

Master box: 50pcs

NINA 270



**NEW VERSION
CCT SETTABLE LAMP**

**up
1160
lm**

CCT SET

LED
R7s
LAMP
INCLUDED

10,5W

8C1.000.P1K



Master box: 30pcs

LORENZA RANGE

SURFACE





MADE IN ITALY







AS1.000.J1K

CCT SETTABLE

SDCM <6

LORENZA LED VERSIONS				
LAMP	POWER	LUMINOUS FLUX UP TO	VOLTAGE RANGE	CCT SETTABLE
 R7s LED	3,5W	365 lm	100-240V 50/60 Hz	6500K/4000K/2700K
 R7s LED	7,5W	790 lm	100-240V 50/60 Hz	6500K/4000K/2700K
 R7s LED	10,5W	1160 lm	100-240V 50/60 Hz	6500K/4000K/2700K

RESIN BODY (MOULDED COLOURS)			DIFFUSER
BLACK (A)	GREY (L)	WHITE (W)	CLEAR (X)
			

LORENZA 150



CCT SET LED R7s LAMP INCLUDED

3,5W AS1.000.J1K

NEW VERSION CCT SETTABLE LAMP

up **365 lm**

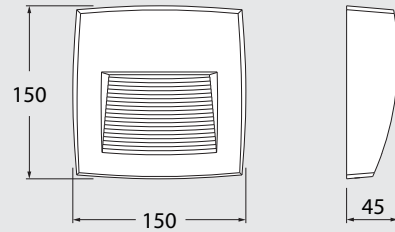

Master box: **24pcs**

LORENZA 190



CCT SET LED R7s LAMP INCLUDED

7,5W AS2.000.K1K

NEW VERSION CCT SETTABLE LAMP

up **790 lm**

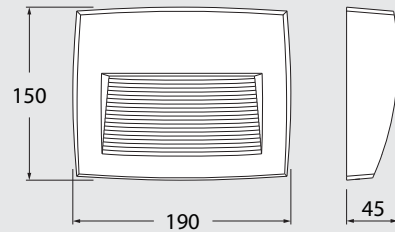

Master box: **24pcs**

LORENZA 270



CCT SET LED R7s LAMP INCLUDED

10,5W AS3.000.P1K

NEW VERSION CCT SETTABLE LAMP

up **1160 lm**

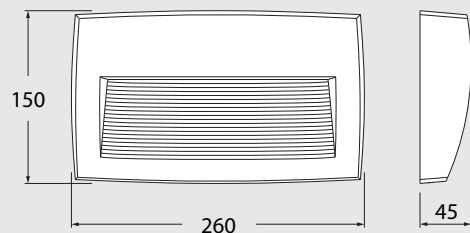

Master box: **14pcs**

LETI RANGE

BRICKLIGHT



2C1.000





CCT SETTABLE

3000 K 4000 K 6500 K

SDCM <6



LETI/EXTRALETI 100 LED VERSIONS					
LAMP	POWER	LUMINOUS FLUX (Φ TOTAL)	VOLTAGE RANGE	CCT SETTABLE	
	3W	410 lm	100-240V 50/60 Hz	6500K/4000K/3000K	 40W INCANDESCENT

AVAILABLE COLORS	
COVER (MOULDED COLOURS)	DIFFUSER
BLACK (A)  GREY (L)  WHITE (W) 	OPAL (Y) 

LETI 100 ROUND

CCT SET LED 3W GX53 LAMP INCLUDED

2C1.000.G1K



NEW VERSION CCT SETTABLE LAMP Master box: **48pcs**

EXTRALETI 100 ROUND

CCT SET LED 3W GX53 LAMP INCLUDED

2S1.000.G1K



NEW VERSION CCT SETTABLE LAMP Master box: **48pcs**

LETI 100 ROUND-GR

CCT SET LED 3W GX53 LAMP INCLUDED

2C2.000.G1K



NEW VERSION CCT SETTABLE LAMP Master box: **48pcs**

EXTRALETI 100 ROUND-GR

CCT SET LED 3W GX53 LAMP INCLUDED

2S2.000.G1K



NEW VERSION CCT SETTABLE LAMP Master box: **48pcs**

LETI 100 ROUND-EL

CCT SET LED 3W GX53 LAMP INCLUDED

2C3.000.G1K



NEW VERSION CCT SETTABLE LAMP Master box: **48pcs**

EXTRALETI 100 ROUND-EL

CCT SET LED 3W GX53 LAMP INCLUDED

2S3.000.G1K



NEW VERSION CCT SETTABLE LAMP Master box: **48pcs**

LETI 100 ROUND-ST

CCT SET LED 3W GX53 LAMP INCLUDED

2C4.000.G1K



NEW VERSION CCT SETTABLE LAMP Master box: **48pcs**



EXTRALETI 100 ROUND-ST



CCT SET LED 3W GX53 LAMP INCLUDED

2S4.000.G1K



NEW VERSION CCT SETTABLE LAMP Master box: **48pcs**

LETI/EXTRALETI 100 LED VERSIONS					
LAMP	POWER	LUMINOUS FLUX (Φ TOTAL)	VOLTAGE RANGE	CCT SETTABLE	
 GX53	3W	410 lm	100-240V 50/60 Hz	6500K/4000K/3000K	 40W INCANDESCENT

AVAILABLE COLORS	
COVER (MOULDED COLOURS)	DIFFUSER
BLACK (A)  GREY (L)  WHITE (W) 	OPAL (Y) 

LETI 100 SQUARE

CCT SET LED 3W GX53 LAMP INCLUDED

3C1.000.G1K

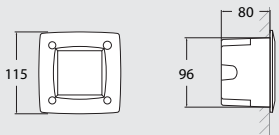



NEW VERSION CCT SETTABLE LAMP Master box: **48pcs**

EXTRALETI 100 SQUARE

CCT SET LED 3W GX53 LAMP INCLUDED

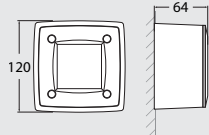
3S1.000.G1K





NEW VERSION CCT SETTABLE LAMP Master box: **48pcs**

LETI 100 SQUARE-GR

CCT SET LED 3W GX53 LAMP INCLUDED

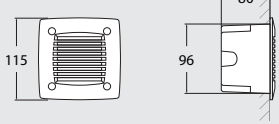
3C2.000.G1K





NEW VERSION CCT SETTABLE LAMP Master box: **48pcs**

EXTRALETI 100 SQUARE-GR

CCT SET LED 3W GX53 LAMP INCLUDED

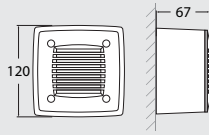
3S2.000.G1K





NEW VERSION CCT SETTABLE LAMP Master box: **48pcs**

LETI 100 SQUARE-EL

CCT SET LED 3W GX53 LAMP INCLUDED

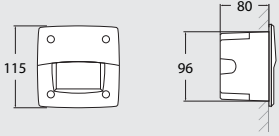
3C3.000.G1K

NEW VERSION CCT SETTABLE LAMP Master box: **48pcs**

EXTRALETI 100 SQUARE-EL

CCT SET LED 3W GX53 LAMP INCLUDED

3S3.000.G1K



NEW VERSION CCT SETTABLE LAMP Master box: **48pcs**

LETI 100 SQUARE-ST

CCT SET LED 3W GX53 LAMP INCLUDED

3C4.000.G1K





NEW VERSION CCT SETTABLE LAMP Master box: **48pcs**



EXTRALETI 100 SQUARE-ST

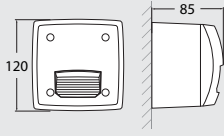



CCT SET LED 3W GX53 LAMP INCLUDED

3S4.000.G1K

NEW VERSION CCT SETTABLE LAMP Master box: **48pcs**

LETI/EXTRALETI 200 LED VERSIONS					
LAMP	POWER	LUMINOUS FLUX (Φ TOTAL)	VOLTAGE RANGE	CCT SETTABLE	
 GX53	3W	410 lm	100-240V 50/60 Hz	6500K/4000K/3000K	 40W INCANDESCENT

AVAILABLE COLORS	
COVER (MOULDED COLOURS)	DIFFUSER
BLACK (A)  GREY (L)  WHITE (W) 	OPAL (Y) 

LETI 200

CCT SET LED 3W GX53 LAMP INCLUDED

4C1.000.G1K

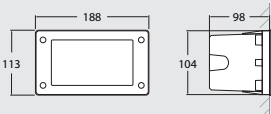
NEW VERSION CCT SETTABLE LAMP Master box: **36pcs**

EXTRALETI 200

CCT SET LED 3W GX53 LAMP INCLUDED

4S1.000.G1K





NEW VERSION CCT SETTABLE LAMP Master box: **36pcs**

LETI 200-GL

CCT SET LED 3W GX53 LAMP INCLUDED

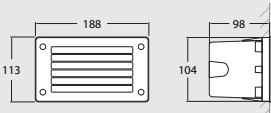
4C2.000.G1K

NEW VERSION CCT SETTABLE LAMP Master box: **36pcs**

EXTRALETI 200-GL

CCT SET LED 3W GX53 LAMP INCLUDED

4S2.000.G1K





NEW VERSION CCT SETTABLE LAMP Master box: **36pcs**

LETI 200-RS

CCT SET LED 3W GX53 LAMP INCLUDED

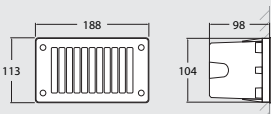
4C3.000.G1K

NEW VERSION CCT SETTABLE LAMP Master box: **36pcs**

EXTRALETI 200-RS

CCT SET LED 3W GX53 LAMP INCLUDED

4S3.000.G1K



NEW VERSION CCT SETTABLE LAMP Master box: **36pcs**

LETI 200-HS

CCT SET LED 3W GX53 LAMP INCLUDED

4C4.000.G1K





NEW VERSION CCT SETTABLE LAMP Master box: **36pcs**

EXTRALETI 200-HS

CCT SET LED 3W GX53 LAMP INCLUDED

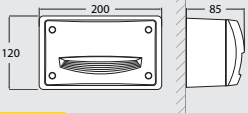
4S4.000.G1K

NEW VERSION CCT SETTABLE LAMP Master box: **36pcs**

LETI 200-VP

CCT SET LED 3W GX53 LAMP INCLUDED

4C5.000.G1K





NEW VERSION CCT SETTABLE LAMP Master box: **36pcs**

EXTRALETI 200-VP

CCT SET LED 3W GX53 LAMP INCLUDED

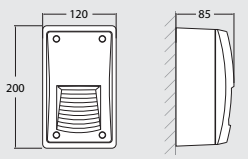
4S5.000.G1K

NEW VERSION CCT SETTABLE LAMP Master box: **36pcs**

LETI 300/EXTRALETI 300

BRICKLIGHT



MADE IN ITALY



551.000

NEW SLIMMER BODY VERSION



CCT SETTABLE

3000 K 4000 K 6500 K

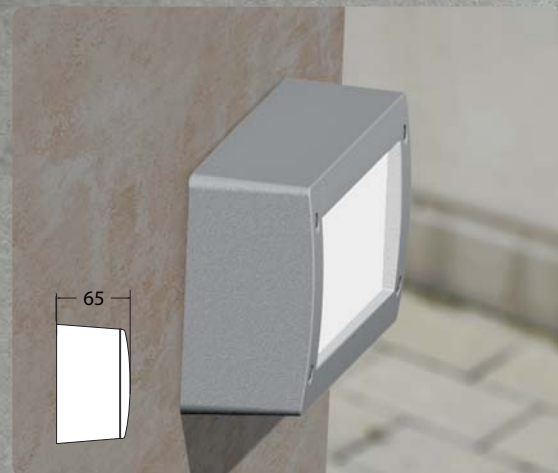
SDCM <6



LETI/EXTRALETI 300 LED VERSIONS					
LAMP	POWER	LUMINOUS FLUX (Φ TOTAL)	VOLTAGE RANGE	CCT SETTABLE	
2x GX53	2x 3W 6W	820 lm	100-240V 50/60 Hz	6500K/4000K/3000K	 75W INCANDESCENT

AVAILABLE COLORS	
COVER (MOULDED COLOURS)	DIFFUSER
BLACK (A)  GREY (L)  WHITE (W) 	OPAL (Y) 

LETI 300

CCT SET LED 3W GX53 LAMP INCLUDED

5C1.000.G2K
E27 5C1.000.E27

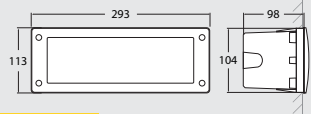



NEW VERSION CCT SETTABLE LAMP Master box: **24pcs**

EXTRALETI 300

CCT SET LED 3W GX53 LAMP INCLUDED

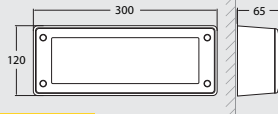
5S1.000.G2K





NEW VERSION CCT SETTABLE LAMP Master box: **20pcs**

LETI 300-GL

CCT SET LED 3W GX53 LAMP INCLUDED

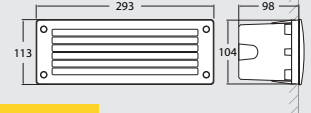
5C2.000.G2K
E27 5C2.000.E27

NEW VERSION CCT SETTABLE LAMP Master box: **24pcs**

EXTRALETI 300-GL

CCT SET LED 3W GX53 LAMP INCLUDED

5S2.000.G2K





NEW VERSION CCT SETTABLE LAMP Master box: **20pcs**

LETI 300-RS

CCT SET LED 3W GX53 LAMP INCLUDED

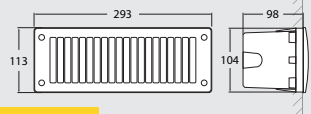
5C3.000.G2K
E27 5C3.000.E27





NEW VERSION CCT SETTABLE LAMP Master box: **24pcs**

EXTRALETI 300-RS

CCT SET LED 3W GX53 LAMP INCLUDED

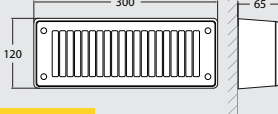
5S3.000.G2K





NEW VERSION CCT SETTABLE LAMP Master box: **20pcs**

LETI 300-HS

CCT SET LED 3W GX53 LAMP INCLUDED

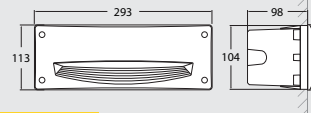
5C4.000.G2K
E27 5C4.000.E27





NEW VERSION CCT SETTABLE LAMP Master box: **24pcs**

EXTRALETI 300-HS

CCT SET LED 3W GX53 LAMP INCLUDED

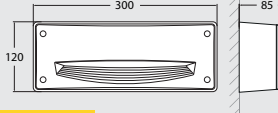
5S4.000.G2K

NEW VERSION CCT SETTABLE LAMP Master box: **20pcs**

LETI 300-VP

CCT SET LED 3W GX53 LAMP INCLUDED

5C5.000.G2K
E27 5C5.000.E27

Master box: **24pcs**

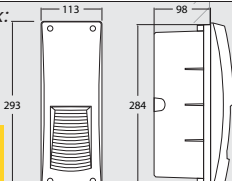
NEW VERSION CCT SETTABLE LAMP

EXTRALETI 300-VP

CCT SET LED 3W GX53 LAMP INCLUDED

5S5.000.G2K

Master box: **20pcs**

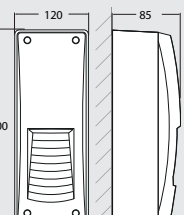
NEW VERSION CCT SETTABLE LAMP

BERTINA

BULKHEAD



BERTINA



BERTA



UMBERTA



MADE IN ITALY



UV-TREATED



ANTI-SHOCK



RECYCLABLE



CE



CB IEC60730-2 SCHEME



IP66



DOUBLE INSULATION CLASS



1B1.000

NO SCREWS AT SIGHT

CCT SETTABLE









SDCM <6





3000 K

4000 K

6500 K



BERTINA LED VERSIONS					
LAMP	POWER	LUMINOUS FLUX (Φ TOTAL)	VOLTAGE RANGE	CCT SETTABLE	
 GX53	3W	410 lm	100-240V 50/60 Hz	6500K/4000K/3000K	 40W INCANDESCENT
 GX53	7W	975 lm	100-240V 50/60 Hz	6500K/4000K/3000K	 75W INCANDESCENT
 GX53	10W	1290 lm	100-240V 50/60 Hz	6500K/4000K/3000K	 100W INCANDESCENT

AVAILABLE COLORS			DIFFUSER
RESIN BODY (MOULDED COLOURS)			
BLACK (A)	GREY (L)	WHITE (W)	OPAL (Y)
			



BERTINA

LED GX53 LAMP INCLUDED CCT SET	3W	1B1.000.G1K
	7W	1B1.000.C1K
	10W	1B1.000.D1K

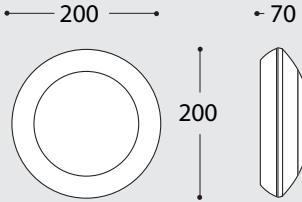

200 70

200

Master box: 45pcs

NEW VERSION
CCT SETTABLE LAMP

AVAILABLE VERSIONS SUPPLIED FULLY PRE-WIRED

GX53 LED-CCT SETTABLE





3W



7W



10W



BERTA

BULKHEAD



BERTINA



BERTA



UMBERTA



MADE IN ITALY



UV TREATED



ANTI SHOCK



RECYCLABLE



CE



CB IEC60598 CB SCHEME



IP66



DOUBLE INSULATION GLASS



1B2.000



NO SCREWS AT SIGHT

CCT SETTABLE

NEW







SDCM <6





2700 K

4000 K

6500 K



BERTA LED VERSIONS NEW					
LAMP	POWER	LUMINOUS FLUX (Φ TOTAL)	VOLTAGE RANGE	CCT SETTABLE	
	7W	790 lm	100-240V 50/60 Hz	6500K/4000K/2700K	 60W INCANDESCENT
	11W	1325 lm	100-240V 50/60 Hz	6500K/4000K/2700K	 100W INCANDESCENT
	18W	2118 lm	100-240V 50/60 Hz	6500K/4000K/2700K	 150W INCANDESCENT

AVAILABLE COLORS		
RESIN BODY <small>(MOULDED COLOURS)</small>		DIFFUSER
 BLACK (A)	 GREY (L)	 OPAL (Y)
 WHITE (W)		



LED
GX53
LAMP
INCLUDED

CCT
SET

NEW VERSION
CCT SETTABLE LAMP

Model	Code
E27	1B2.000.P27
E27 WITH SENSOR)))	1B2.000.PS7
7W LED	1B2.000.A1K
11W LED	1B2.000.B1K
18W LED	1B2.000.E1K

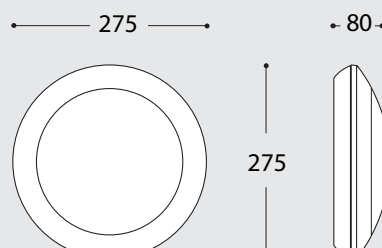

Master box: 16pcs

AVAILABLE VERSIONS SUPPLIED FULLY PRE-WIRED

E27



E27 +SENSOR



GX53 LED





UMBERTA

BULKHEAD



BERTINA



BERTA



UMBERTA



MADE IN ITALY



1B3.000











**NO SCREWS
AT SIGHT**

CCT SETTABLE **NEW**

2700 K 4000 K 6500 K

SDCM <6

UMBERTA LED VERSIONS NEW					
LAMP	POWER	LUMINOUS FLUX (Φ TOTAL)	VOLTAGE RANGE	CCT SETTABLE	
	7W	790 lm	100-240V 50/60 Hz	6500K/4000K/2700K	 60W INCANDESCENT
	11W	1325 lm	100-240V 50/60 Hz	6500K/4000K/2700K	 100W INCANDESCENT
	18W	2118 lm	100-240V 50/60 Hz	6500K/4000K/2700K	 150W INCANDESCENT

AVAILABLE COLORS			DIFFUSER
RESIN BODY (MOULDED COLOURS)			
BLACK (A)	GREY (L)	WHITE (W)	OPAL (Y)
			



LED
GX53
LAMP
INCLUDED

CCT
SET

UMBERTA

E27	1B3.000.E27
2x E27	1B3.000.E28
7W LED	1B3.000.A1K
11W LED	1B3.000.B1K
18W LED	1B3.000.E1K

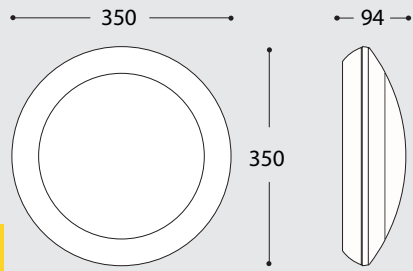

Master box: 12pcs

NEW VERSION CCT SETTABLE LAMP

AVAILABLE VERSIONS SUPPLIED FULLY PRE-WIRED

E27



2x E27





GX53 LED



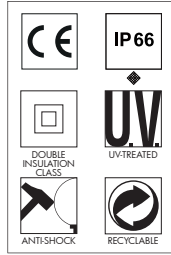
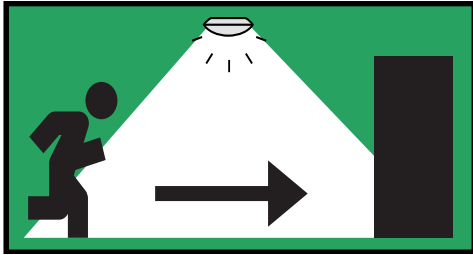

EMERGENCY



UMBERTA EMERGENCY - LED VERSIONS					
EMERGENCY KIT	MODE	POWER	LUMINOUS FLUX (Φ TOTAL) UP TO	VOLTAGE RANGE	COLOUR TEMPERATURE
	NORMAL	15W	2000 lm	220-240V 50/60 Hz	4000K
	EMERGENCY (min 3 hours)	2,4W	250 lm	220-240V 50/60 Hz	4000K

UMBERTA LED MAINTAINED EMERGENCY

LED 4000K 1B3.000.EM1

PRODUCT TYPE	Wall and Ceiling bulkhead with Emergency kit
OPERATING VOLTAGE	220~240 vAC
LUMINOUS FLUX & POWER	2000 lumen (Normal mode), 15W 250 lumen (Emergency mode), 2.4W
LED TYPE	Edison SMD 2835, 4000 K
CRI	>80Ra
PF (POWER FACTOR)	>0.95
BEAM ANGLE	120°
OPERATING TEMPERATURE	0~50°C
BATTERY	Ni-MH, BK370Ah3.6V, Panasonic (3.5Ah, 3.6V)
BATTERY OPERATING TIME	min 3 hours (250 lumen)
BATTERY CHARGING TIME	24 hours
Drivers Standards	EN 61347-1, EN 61347-2-7, EN 61347-2-13, EN 62384, EN 60598-2-22 EN 55015, EN61547, EN 61000-3-2, EN 61000-3-3
Battery Standards	EN 5501-1, EN 61000, EN 55014-2

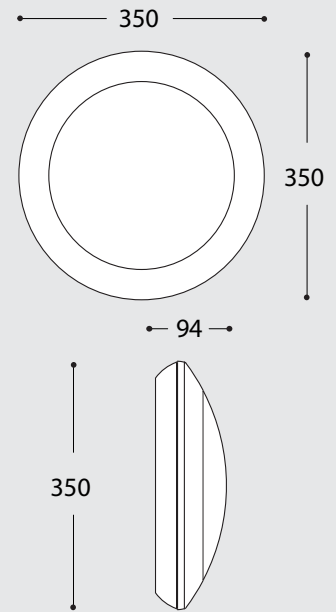

Provided with built-in test button to check battery status.



HOW IT WORKS

In case of blackout, the emergency kit turns on. The Bulkhead switches from Normal mode to Emergency mode and keeps on working.



Green Led: identifies the emergency light and shows that the system is operating correctly.

SENSOR

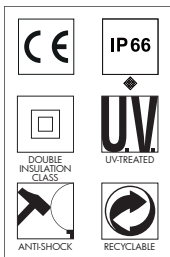
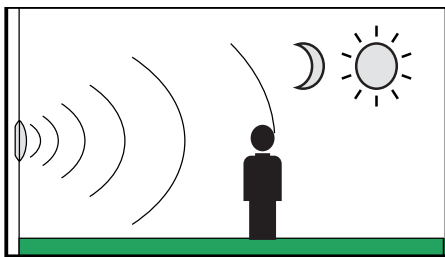

BERTA LED VERSIONS NEW					
LAMP	POWER	LUMINOUS FLUX (Φ TOTAL)	VOLTAGE RANGE	CCT SETTABLE	
	7W	790 lm	100-240V 50/60 Hz	6500K/4000K/2700K	= 60W INCANDESCENT
	11W	1325 lm	100-240V 50/60 Hz	6500K/4000K/2700K	= 100W INCANDESCENT
	18W	2118 lm	100-240V 50/60 Hz	6500K/4000K/2700K	= 150W INCANDESCENT

UMBERTA MOTION & DAYLIGHT SENSOR

E27 WITH SENSOR)))	1B3.000.ES7	34
2x E27 WITH SENSOR)))	1B3.000.ES8	34
7W LED GX53 WITH SENSOR))) CCT SET	1B3.000.ASK	44
11W LED GX53 WITH SENSOR))) CCT SET	1B3.000.BSK	44
18W LED GX53 WITH SENSOR))) CCT SET	1B3.000.ESK	44

Product Type	Wall and Ceiling bulkhead with Motion&Daylight sensor
Sensor operating voltage	220-240 vAC (120v version available on demand)
Version	GX53 LED, E27, 2xE27
Sensor Operating Temperature	-10° +60°C
Detection angle	30° - 150°
Fields of detection	1 - up to 5 mt (adjustable)

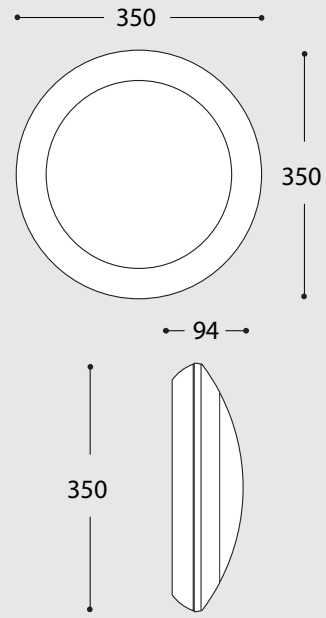

MADE IN ITALY

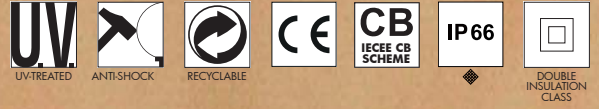

1G3.000







SUPPLIED FULLY PRE-WIRED







CCT SETTABLE



NEW

LED BULKHEAD GX53 NEW					
LAMP	POWER	LUMINOUS FLUX (Φ TOTAL)	VOLTAGE RANGE	CCT SETTABLE	
	7W	790 lm	100-240V 50/60 Hz	6500K/4000K/2700K	 60W INCANDESCENT
	11W	1325 lm	100-240V 50/60 Hz	6500K/4000K/2700K	 100W INCANDESCENT
	18W	2118 lm	100-240V 50/60 Hz	6500K/4000K/2700K	 150W INCANDESCENT

AVAILABLE COLORS		
RESIN BODY (MOULDED COLOURS)		DIFFUSER
BLACK (A)	GREY (L)	WHITE (W)
		
		OPAL (Y) 

GELMI



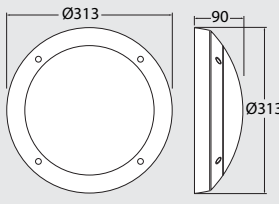

LED
GX53
LAMP
INCLUDED

CCT
SET

E27	1G3.000.E27
GX53 LED 7W	1G3.000.A1K
GX53 LED 11W	1G3.000.B1K
GX53 LED 18W	1G3.000.E1K

NEW VERSION
CCT SETTABLE LAMP

Master box: **16pcs**

GELMI-EL

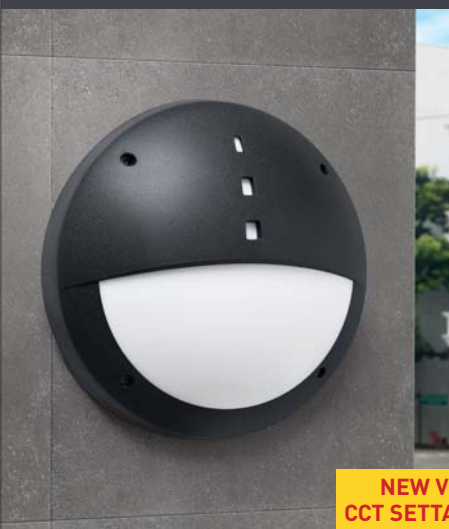

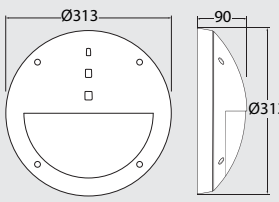

LED
GX53
LAMP
INCLUDED

CCT
SET

E27	2G3.000.E27
GX53 LED 7W	2G3.000.A1K
GX53 LED 11W	2G3.000.B1K
GX53 LED 18W	2G3.000.E1K

NEW VERSION
CCT SETTABLE LAMP

Master box: **16pcs**

GELMI-GR



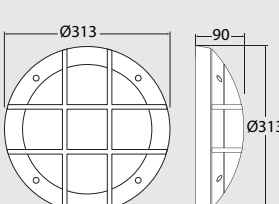

LED
GX53
LAMP
INCLUDED

CCT
SET

E27	3G3.000.E27
GX53 LED 7W	3G3.000.A1K
GX53 LED 11W	3G3.000.B1K
GX53 LED 18W	3G3.000.E1K

NEW VERSION
CCT SETTABLE LAMP

Master box: **16pcs**



1D3.000

SUPPLIED FULLY PRE-WIRED







CCT SETTABLE



LED BULKHEAD GX53				
LAMP	POWER	LUMINOUS FLUX (Φ TOTAL)	VOLTAGE RANGE	CCT SETTABLE
	7W	790 lm	100-240V 50/60 Hz	6500K/4000K/2700K
	11W	1325 lm	100-240V 50/60 Hz	6500K/4000K/2700K
	18W	2118 lm	100-240V 50/60 Hz	6500K/4000K/2700K

NEW

AVAILABLE COLORS		
RESIN BODY (MOULDED COLOURS)		DIFFUSER
BLACK (A)	GREY (L)	WHITE (W)
		
		OPAL (Y) 

DANZI



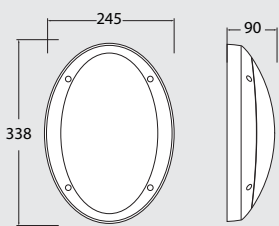

LED
GX53 LAMP INCLUDED
CCT SET

E27	1D3.000.E27
GX53 LED 7W	1D3.000.A1K
GX53 LED 11W	1D3.000.B1K
GX53 LED 18W	1D3.000.E1K

NEW VERSION CCT SETTABLE LAMP

Master box: **16pcs**

DANZI-VE



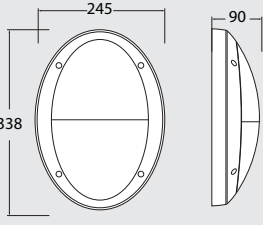

LED
GX53 LAMP INCLUDED
CCT SET

E27	2D3.000.E27
GX53 LED 7W	2D3.000.A1K
GX53 LED 11W	2D3.000.B1K
GX53 LED 18W	2D3.000.E1K

NEW VERSION CCT SETTABLE LAMP

Master box: **16pcs**

DANZI-GR



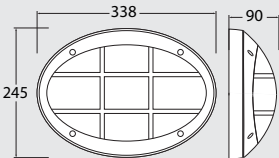

LED
GX53 LAMP INCLUDED
CCT SET

E27	3D3.000.E27
GX53 LED 7W	3D3.000.A1K
GX53 LED 11W	3D3.000.B1K
GX53 LED 18W	3D3.000.E1K

NEW VERSION CCT SETTABLE LAMP

Master box: **16pcs**



1U3.000



CCT SETTABLE **NEW**

2700 K 4000 K 6500 K

SDCM <6

SUPPLIED FULLY PRE-WIRED

GX53 LED	E27	E27 + SENSOR
		WITH SENSOR))) 220-240V (.ES7)

BACKLIT COLOURS AVAILABLE

*To order the backlit version of our bulkhead, the following suffixes have to be added at the end of the code.

CLEAR .CL1	PINK .PK1	BLUE .BU1	GREEN .GN1	ORANGE .OR1

LED BULKHEAD GX53					NEW
LAMP	POWER	LUMINOUS FLUX (Φ TOTAL)	VOLTAGE RANGE	CCT SETTABLE	
	7W	790 lm	100-240V 50/60 Hz	6500K/4000K/2700K	60W INCANDESCENT
	11W	1325 lm	100-240V 50/60 Hz	6500K/4000K/2700K	100W INCANDESCENT
	18W	2118 lm	100-240V 50/60 Hz	6500K/4000K/2700K	150W INCANDESCENT

AVAILABLE COLORS	
RESIN BODY (MOULDED COLOURS)	DIFFUSER
BLACK (A) GREY (L) WHITE (W)	OPAL (Y)

STUCCHI

**NEW VERSION
CCT SETTABLE LAMP**

E27	1U3.000.E27
GX53 LED 7W	1U3.000.A1K
GX53 LED 11W	1U3.000.B1K
GX53 LED 18W	1U3.000.E1K

LED GX53 LAMP INCLUDED
CCT SET

BACKLIT COLOURS VERSION

*To order the backlit version of our bulkhead, the following suffixes have to be added at the end of the code.

CLEAR .CL1
PINK .PK1
BLUE .BU1
GREEN .GN1
ORANGE .OR1

Master box: **16pcs**

CECCHI

**NEW VERSION
CCT SETTABLE LAMP**

E27	1H3.000.E27
GX53 LED 7W	1H3.000.A1K
GX53 LED 11W	1H3.000.B1K
GX53 LED 18W	1H3.000.E1K

LED GX53 LAMP INCLUDED
CCT SET

BACKLIT COLOURS VERSION

*To order the backlit version of our bulkhead, the following suffixes have to be added at the end of the code.

CLEAR .CL1
PINK .PK1
BLUE .BU1
GREEN .GN1
ORANGE .OR1

Master box: **16pcs**

RITA

**NEW VERSION
CCT SETTABLE LAMP**

E27	1T3.000.E27
GX53 LED 7W	1T3.000.A1K
GX53 LED 11W	1T3.000.B1K
GX53 LED 18W	1T3.000.E1K

LED GX53 LAMP INCLUDED
CCT SET

PAINTED COLOURS

*To order the painted colour version of RITA, the following suffixes have to be added at the end of the code.

MOULDED COLOURS
 BLACK(A) WHITE(W)

ANTIQUE GREEN(V) ANTIQUE BRONZE(B)

Master box: **12pcs**

LUCIA

BULKHEAD



CCT SETTABLE NEW

2700 K 4000 K 6500 K

SDCM <6

BACKLIT COLOURS AVAILABLE

*To order the backlit version of our bulkhead, the following suffixes have to be added at the end of the code.

CLEAR .CL1	PINK .PK1	BLUE .BU1	GREEN .GN1	ORANGE .OR1

SUPPLIED FULLY PRE-WIRED

GX53 LED	E27	E27 + SENSOR
		WITH SENSOR))) 220-240V (.ES7)

BRACKET VERSION AVAILABLE

2R3.602

LED BULKHEAD GX53				
LAMP	POWER	LUMINOUS FLUX (Φ TOTAL)	VOLTAGE RANGE	CCT SETTABLE
	7W	790 lm	100-240V 50/60 Hz	6500K/4000K/2700K
	11W	1325 lm	100-240V 50/60 Hz	6500K/4000K/2700K
	18W	2118 lm	100-240V 50/60 Hz	6500K/4000K/2700K

NEW

AVAILABLE COLORS		
RESIN BODY (MOULDED COLOURS)		DIFFUSER
BLACK (A)	GREY (L)	OPAL (Y)
WHITE (W)		



LED GX53 LAMP INCLUDED
CCT SET

NEW VERSION CCT SETTABLE LAMP

LUCIA	
E27	1R3.000.E27
GX53 LED 7W	1R3.000.A1K
GX53 LED 11W	1R3.000.B1K
GX53 LED 18W	1R3.000.E1K

REMI/LUCIA	
E27	1R3.602.E27
GX53 LED 7W	1R3.602.A1K
GX53 LED 11W	1R3.602.B1K
GX53 LED 18W	1R3.602.E1K

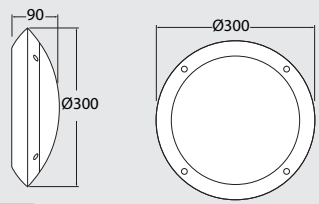

Master box: 16pcs

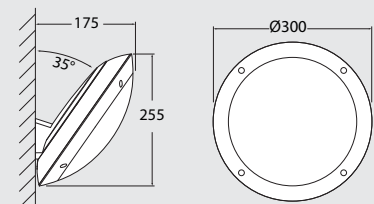

Master box: 16pcs



LED GX53 LAMP INCLUDED
CCT SET

NEW VERSION CCT SETTABLE LAMP

LUCIA-EL	
E27	2R3.000.E27
GX53 LED 7W	2R3.000.A1K
GX53 LED 11W	2R3.000.B1K
GX53 LED 18W	2R3.000.E1K

REMI/LUCIA-EL	
E27	2R3.602.E27
GX53 LED 7W	2R3.602.A1K
GX53 LED 11W	2R3.602.B1K
GX53 LED 18W	2R3.602.E1K

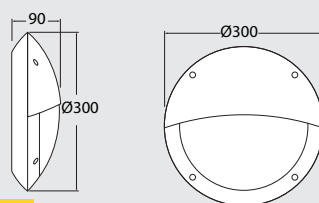

Master box: 16pcs

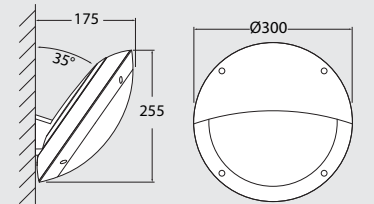

Master box: 16pcs



LED GX53 LAMP INCLUDED
CCT SET

NEW VERSION CCT SETTABLE LAMP

LUCIA-GD	
E27	3R3.000.E27
GX53 LED 7W	3R3.000.A1K
GX53 LED 11W	3R3.000.B1K
GX53 LED 18W	3R3.000.E1K

REMI/LUCIA-GD	
E27	3R3.602.E27
GX53 LED 7W	3R3.602.A1K
GX53 LED 11W	3R3.602.B1K
GX53 LED 18W	3R3.602.E1K

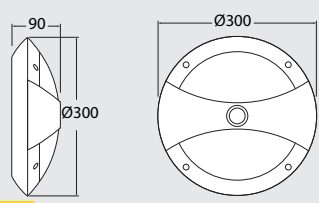

Master box: 16pcs

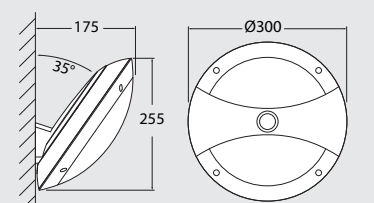

Master box: 16pcs

MADDI

BULKHEAD



MADE IN ITALY



1V3.000

CCT SETTABLE NEW

2700 K 4000 K 6500 K

SDCM <6

BACKLIT COLOURS AVAILABLE

*To order the backlit version of our bulkhead, the following suffixes have to be added at the end of the code.

CLEAR .CL1	PINK .PK1	BLUE .BU1	GREEN .GN1	ORANGE .OR1

SUPPLIED FULLY PRE-WIRED

GX53 LED	E27	E27 + SENSOR
		WITH SENSOR))) 220-240V (.ES7)

BRACKET VERSION AVAILABLE

1V3.602

LED BULKHEAD GX53				
LAMP	POWER	LUMINOUS FLUX (Φ TOTAL)	VOLTAGE RANGE	CCT SETTABLE
	7W	790 lm	100-240V 50/60 Hz	6500K/4000K/2700K
	11W	1325 lm	100-240V 50/60 Hz	6500K/4000K/2700K
	18W	2118 lm	100-240V 50/60 Hz	6500K/4000K/2700K

NEW

AVAILABLE COLORS		
RESIN BODY (MOULDED COLOURS)		DIFFUSER
BLACK (A)	GREY (L)	OPAL (Y)
WHITE (W)		



LED GX53 LAMP INCLUDED
CCT SET

NEW VERSION CCT SETTABLE LAMP

MADDI		REMI/MADDI	
E27	1V3.000.E27	E27	1V3.602.E27
GX53 LED 7W	1V3.000.A1K	GX53 LED 7W	1V3.602.A1K
GX53 LED 11W	1V3.000.B1K	GX53 LED 11W	1V3.602.B1K
GX53 LED 18W	1V3.000.E1K	GX53 LED 18W	1V3.602.E1K
Master box: 16pcs		Master box: 16pcs	



LED GX53 LAMP INCLUDED
CCT SET

NEW VERSION CCT SETTABLE LAMP

MADDI-VE		REMI/MADDI-VE	
E27	2V3.000.E27	E27	2V3.602.E27
GX53 LED 7W	2V3.000.A1K	GX53 LED 7W	2V3.602.A1K
GX53 LED 11W	2V3.000.B1K	GX53 LED 11W	2V3.602.B1K
GX53 LED 18W	2V3.000.E1K	GX53 LED 18W	2V3.602.E1K
Master box: 16pcs		Master box: 16pcs	



LED GX53 LAMP INCLUDED
CCT SET

NEW VERSION CCT SETTABLE LAMP

MADDI-HL		REMI/MADDI-HL	
E27	3V3.000.E27	E27	3V3.602.E27
GX53 LED 7W	3V3.000.A1K	GX53 LED 7W	3V3.602.A1K
GX53 LED 11W	3V3.000.B1K	GX53 LED 11W	3V3.602.B1K
GX53 LED 18W	3V3.000.E1K	GX53 LED 18W	3V3.602.E1K
Master box: 16pcs		Master box: 16pcs	







GIORGIO / ROSA







POST



AVAILABLE COLORS			
RESIN BODY (MOULDED COLOURS)			DIFFUSER
BLACK (A)	GREY (L)	WHITE (W)	OPAL (Y)

AVAILABLE VERSIONS		
GX53 LED	4x GX53	2x E27
<p>LED GX53</p>	<p>LED GX53</p>	

GIORGIO LED VERSIONS					
LAMP	POWER	LUMINOUS FLUX (Φ TOTAL)	VOLTAGE RANGE	CCT SETTABLE	
	11W	1325lm	100-240V 50/60 Hz	6500K/4000K/3000K	=  100W INCANDESCENT
	18W	2118 lm	100-240V 50/60 Hz	6500K/4000K/3000K	=  150W INCANDESCENT
	4x7W 28W	3900 lm	100-240V 50/60 Hz	6500K/4000K/3000K	=  70W HQI-SON
	4x10W 40W	5160 lm	100-240V 50/60 Hz	6500K/4000K/3000K	=  100W HQI-SON

ROSA LED VERSIONS					
LAMP	POWER	LUMINOUS FLUX (Φ TOTAL)	VOLTAGE RANGE	CCT SETTABLE	
	2x11W 22W	2650 lm	100-240V 50/60 Hz	6500K/4000K/3000K	=  2x100W INCANDESCENT
	2x18W 36W	4326 lm	100-240V 50/60 Hz	6500K/4000K/3000K	=  2x150W INCANDESCENT
	2x28W 56W	7800 lm	100-240V 50/60 Hz	6500K/4000K/3000K	=  2x70W HQI-SON
	2x40W 80W	10320 lm	100-240V 50/60 Hz	6500K/4000K/3000K	=  2x100W HQI-SON

EKTOR 2500 /GIORGIO	
E27	4P2.361.G10.E28
11W	4P1.361.G10.B1K
18W	4P1.361.G10.E1K
4x7W 28W	4P2.361.G10.C4K
4x10W 40W	4P2.361.G10.D4K

LED
GX53
LAMP
INCLUDED

**CCT
SET**

EKTOR 2500 /ROSA	
2x E27	4P2.361.G20.E28
2x 11W	4P1.361.G20.B1K
2x 18W	4P1.361.G20.E1K
2x28W	4P2.361.G20.C4K
2x40W	4P2.361.G20.D4K

LED
GX53
LAMP
INCLUDED

**CCT
SET**

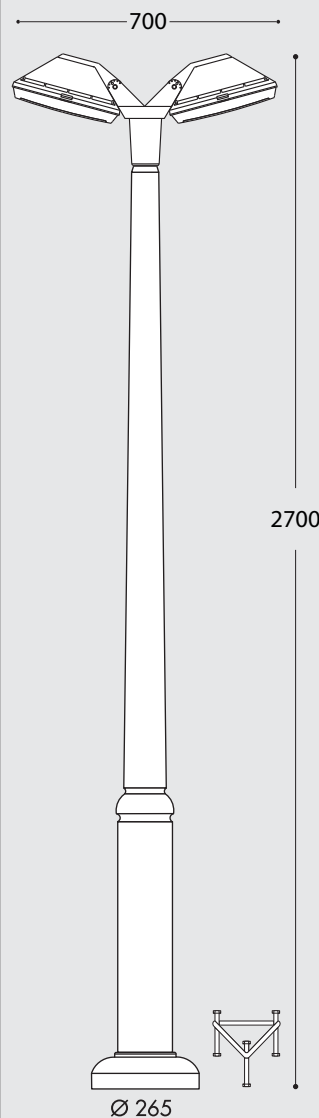
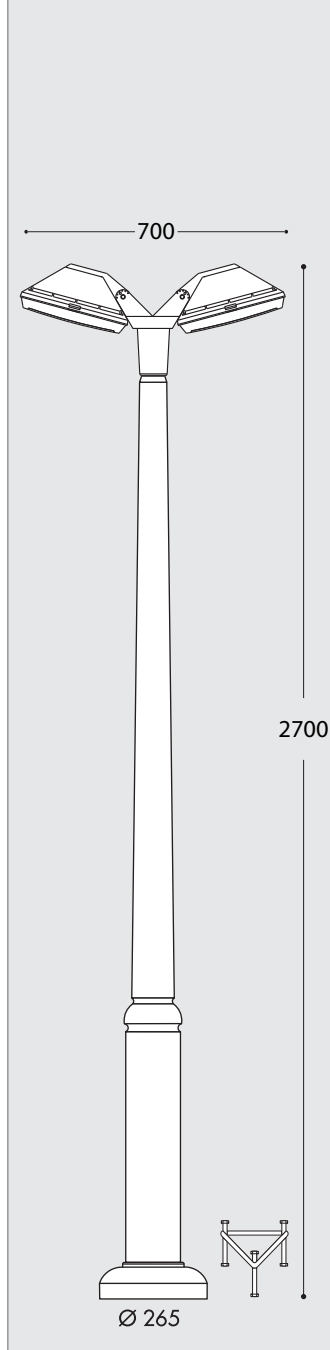
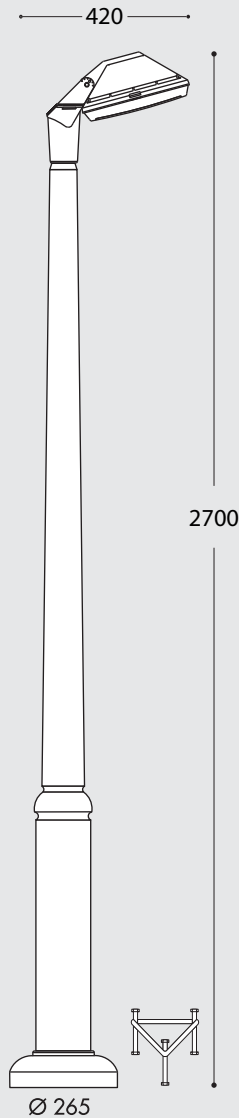

BEPPE 400/VIVI 400

POST



NEW HIGH POWER LED

**INDOOR &
OUTDOOR
USE**

+80°C
-30°

90%
HUMIDITY





VOLTAGE SURGE
RESISTANT



30W (3620 lm)
50W (6550 lm)



More details at page 96

BEPPE-VIVI 400 HIGH POWER LED					
LAMP	POWER	LUMINOUS FLUX UP TO	VOLTAGE RANGE	COLOUR TEMPERATURE	
 HIGH POWER LED E27	30W	3620 lm	100-240V 50/60 Hz	3000K/ 4000K	 70W HQI-SON
 HIGH POWER LED E27	50W	6550 lm	100-240V 50/60 Hz	4000K 3000K	 70W HQI-SON

AVAILABLE COLORS					
RESIN BODY (MOULDED COLOURS)			DIFFUSER		
BLACK (A)	GREY (L)	WHITE (W)	CLEAR (X)	OPAL (Y)	
					

EKTOR 2500 / BEPPE400			
30W LED	CCT SET	P50.361.Q1K	NEW
50W LED	4000K 3000K	P50.361.H1L P50.361.H1R	

EKTOR 2500 MIDIPILAR / VIVI400 1L			
30W LED	CCT SET	V50.361.A10.Q1K	NEW
50W LED	4000K 3000K	V50.361.A10.H1L V50.361.A10.H1R	

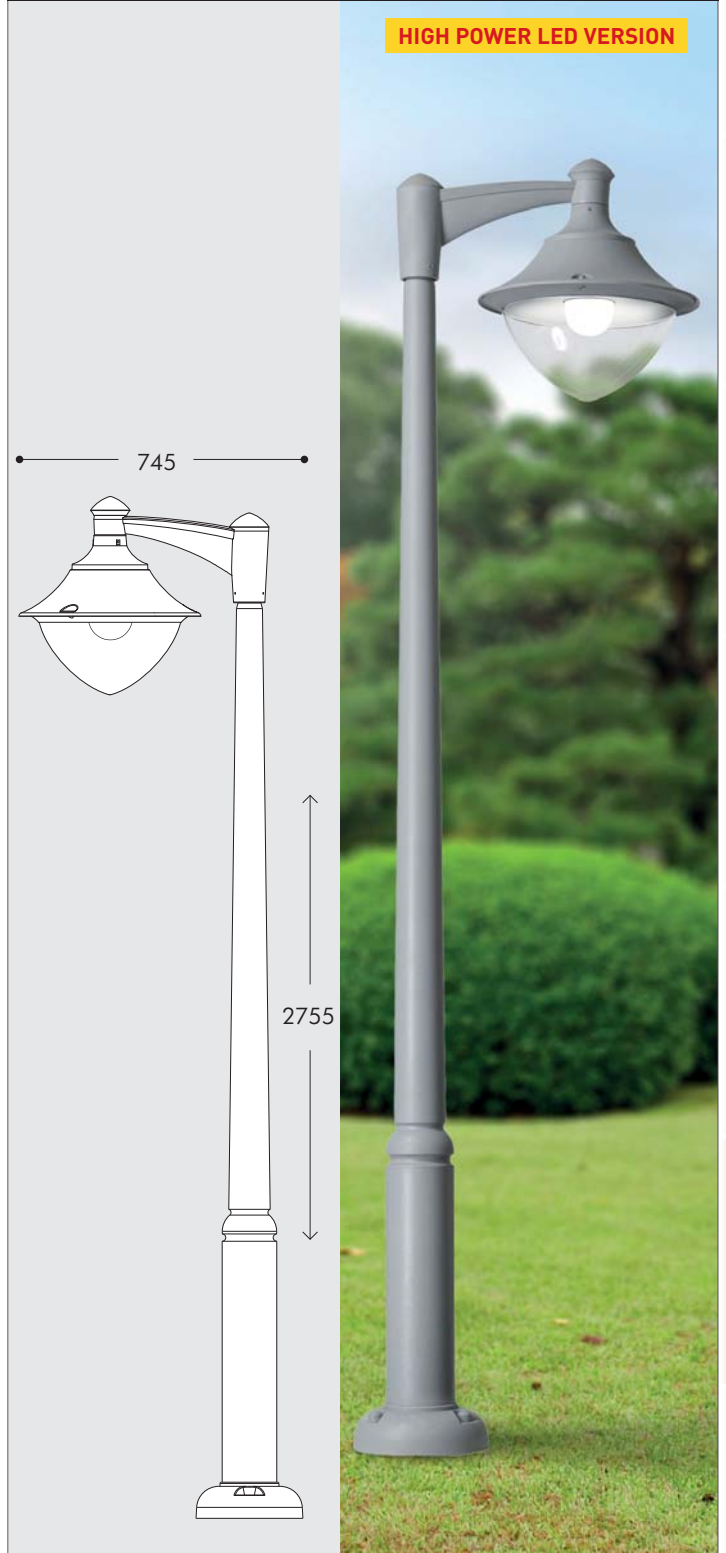
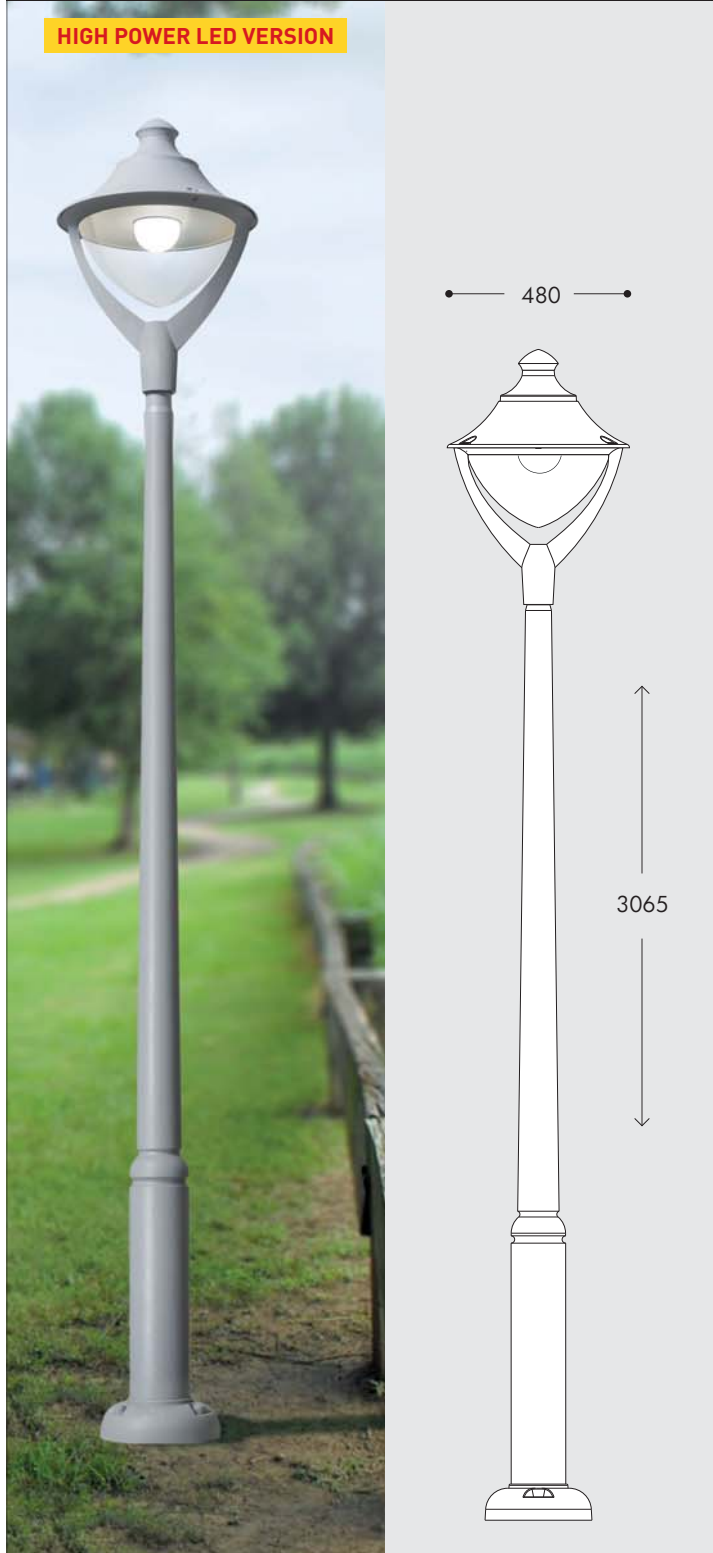

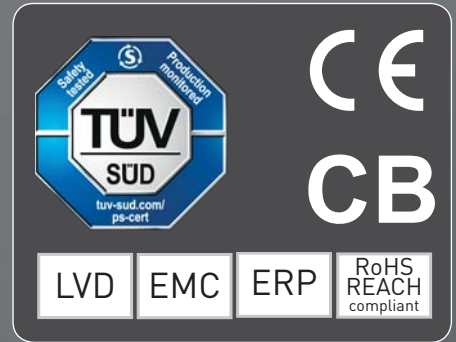



Power surges resistant

- **Wide voltage range (100-240V)** to protect the driver both from voltage droop and voltage overshoot, which are quite frequent in case of outdoor installations.
- **Double 400V capacitors** and multiple resistances to withstand power surges.
- **Silicone paste** to avoid – in case of voltage swings - the vibration of the electronic components of the driver and the consequent risk of components unsoldering.



Heat resistant - Working temperature -30°+80°C

- **Gold wire bonding:** Chips connected by pure gold wires, which are able to withstand at the highest and lowest temperatures and at temperature fluctuations between day and night. The gold wire bonding can grant a lumens maintenance factor > 80%.
- **Silicone paste:** Thermoconductive silicone paste with metal powder inside for helping heat dissipation and avoid overheating problems and for protecting the electronic components in case of high and low temperatures.



Humidity resistant - Weatherproof driver for a longer lifetime

- **Silicone paste:** The driver is fully enclosed in a special silicone paste, which ensures the highest driver protection against moisture and humidity up to 90%, both unavoidable in outdoor installations.



LVD TESTED

LVD Certificate: Fumagalli lamps fulfil the Low Voltage Directive 2014/35/EU, therefore are CE marked and comply with safety requirements like protection against electrical shock, moisture and heat resistance, resistance to flame and ignition.

EMC TESTED

EMC Certificate: Fumagalli lamps meet the Electromagnetic Compatibility Directive 2014/30/EU and its amendments.

NEW ERP

New ERP Attestation of conformity: Fumagalli lamps fulfil the NEW European Ecodesign Directive EU 2019/2020, which sets stricter energy efficiency requirements, new verification tolerances and other factors such as bulb lifetime and warm-up time.

CB IEC/IECEE CB SCHEME

IECEE CB Certificate: Fumagalli lamps meet the International System for Conformity and Certification of Electrotechnical Equipment allowing direct market access in more than 50 countries all over the world.

RoHS REACH COMPLIANT

RoHS REACH compliant: Fumagalli lamps fulfil the RoHS (Restriction of Hazardous Substances) directive 2011/65/EU and its amendments and the REACH regulation (EC) No. 1907/2006, regarding the concentration of Very High Concern Substances (SVHC).



Tested according to :
EN 62560:2012/A1: 2015
IEC/TR 62778:2014
EN 62493:2015



TÜV CERTIFIED LED MODULES



INDOOR & OUTDOOR USE

-30 +80 °C

90% HUMIDITY

VOLTAGE SURGE RESISTANT



LENS

- Opal color lens reducing dazzle.
- Made of UV stabilized resin material to avoid yellowing process.
- Special lens design for a better light distribution.



GOLD WIRE BONDING

- LED chips connected by gold wires able to withstand at the highest and lowest temperatures and granting a lumens maintenance factor > 80%.



DRIVER 100-240V

- IC isolated driver technology.
- Wide voltage range: **100-240V** +/- 10% tolerance to protect the driver both from voltage droop and voltage overshoot.



CCT SETTABLE



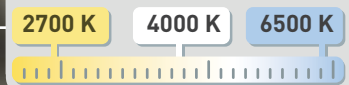
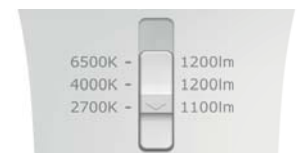



- Switch settable in three different positions, to select the desired Kelvin temperature (2700K, 4000K, 6500K) and get a customized ambiance.
- 2700K, 4000K and 6500K led chips on 3 separate circuits to grant SDCM < 6.





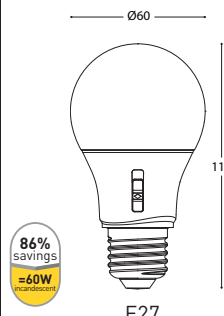
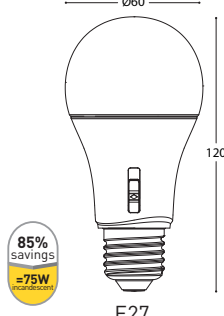
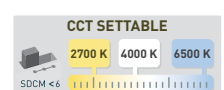
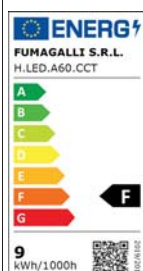
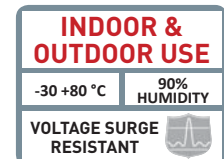



6500K - 1200lm
4000K - 1200lm
2700K - 1100lm

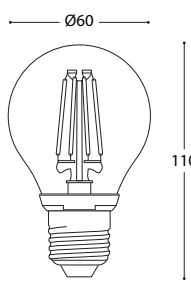

E27 LED A60- CCT SETTABLE

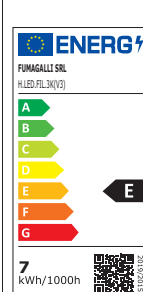

 	POWER	8,5 W	11 W	
	LUMINOUS FLUX (Φ TOTAL)	2700 K	840 lm	1100 lm
		4000 K	920 lm	1200 lm
	6500 K	920 lm	1200 lm	
SIZE & SOCKET	 <p>86% savings =60W incandescent</p>		 <p>85% savings =75W incandescent</p>	
	E27		E27	
VOLTAGE		100-240 V	100-240 V	
FREQUENCY		50/60 Hz	50/60 Hz	
DISPLACEMENT FACTOR		>0,5	>0,7	
PSTLM (NO FLICKER)		< 1	< 1	
SVM		< 0,4	< 0,4	
CRI		> 80	> 80	
SDCM		<6	<6	
LIFETIME		25.000 h	25.000 h	
EFFICIENCY CLASS		F	F	
REF. CODE		H.LED.A60.CCT	H2.LED.A60.CCT	
 <p>CCT SETTABLE 2700 K 4000 K 6500 K SDCM <6</p>		 <p>ENERGY FUMAGALLI S.R.L. H.LED.A60.CCT A B C D E F G 9 kWh/1000h</p>		
 <p>INDOOR & OUTDOOR USE -30 +80 °C 90% HUMIDITY VOLTAGE SURGE RESISTANT</p>		 <p>TUV SUD LVD EMC CB ERP</p>		
 <p>IECEE CB SCHEME IECEE CB CERTIFICATE: SG PSB-LE-03297</p>		 <p>COMPLY WITH: EU 2019/2015 EU 2019/2020</p>		

E27 LED FILAMENT A60

	POWER	6,5 W
	LUMINOUS FLUX (Φ TOTAL)	2700 K 800 lm
SIZE & SOCKET		
	E27	
VOLTAGE		100-240 V
FREQUENCY		50/60 Hz
DISPLACEMENT FACTOR		>0,5
CRI		> 80
SWITCHING CYCLE		>100.000
WARM UP TIME		≤ 0,5"
LIFETIME		25.000 h
EFFICIENCY CLASS		E
REF. CODE		H.LED.FIL.3K
 <p>SILICONE PROTECTION DRIVER INDOOR & OUTDOOR USE -30 +80 °C 90% HUMIDITY VOLTAGE SURGE RESISTANT</p>		 <p>90% savings =60W incandescent</p>
 <p>ENERGY FUMAGALLI SRL H.LED.FIL.3K(V3) A B C D E F G 7 kWh/1000h</p>		 <p>TUV SUD LVD EMC CB ERP</p>
 <p>IECEE CB SCHEME IECEE CB CERTIFICATE: SG PSB-LE-01711</p>		 <p>COMPLY WITH: EU 2019/2015 EU 2019/2020</p>

4 NEWS
16 BOLLARD
34 UP&DOWN
44 FLOODLIGHT
54 IN-GROUND
60 BRICKLIGHT
70 BULKHEAD
88 POST
92 LAMPS

E27 HIGH POWER LED

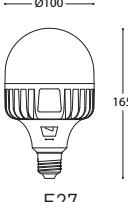
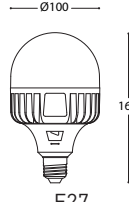
 	POWER		15 W	30W
	LUMINOUS FLUX (Φ TOTAL)	3000 K	1545 lm	3325lm
4000 K		1690 lm	3620 lm	
SIZE & SOCKET				
	NEW VERSION CCT SETTABLE LAMP			
<p>CCT SETTABLE</p> <p>3000 K 4000 K</p> <p>SDCM <6</p> <p>SILICONE PROTECTION DRIVER</p> <p>INDOOR & OUTDOOR USE</p> <p>-30 +80 °C 90% HUMIDITY</p> <p>VOLTAGE SURGE RESISTANT</p> <p>ENERGY</p> <p>FUMAGALLI SRL H.LED.HIP.CCT</p> <p>A B C D E F G</p> <p>30 kWh/1000h</p> <p>COMPLY WITH: EU 2019/2015 EU 2019/2020</p> <p>TUV SUD</p> <p>CE LVD CB EMC ERP</p> <p>IECEE CB SCHEME</p> <p>IECEE CB CERTIFICATE: SG PSB-LE-01712 SG PSB-LE-01708</p>	VOLTAGE	100-240 V		100-240 V
	FREQUENCY	50/60 Hz		50/60 Hz
	DISPLACEMENT FACTOR	>0,7		>0,9
	PSTLM (NO FLICKER)	<1		<1
	SVM	0,4		0,4
	CRI	> 80		> 80
	SDCM	<6		<6
	SWITCHING CYCLE	30.000		30.000
	WARM UP TIME	< 0,5"		< 1"
	LIFETIME	25.000 h		25.000 h
	EFFICIENCY CLASS	F		E
	REF. CODE	H3.LED.HIP.CCT		H2.LED.HIP.CCT

E27 HIGH POWER LED

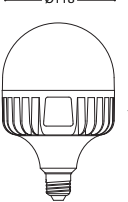
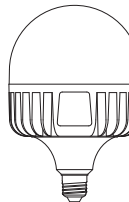
	POWER		50 W	60W
	LUMINOUS FLUX (Φ TOTAL)	3000 K	5850 lm	6800 lm
4000 K		6550 lm	7600 lm	
SIZE & SOCKET				
	<p>SILICONE PROTECTION DRIVER</p> <p>INDOOR & OUTDOOR USE</p> <p>-30 +80 °C 90% HUMIDITY</p> <p>VOLTAGE SURGE RESISTANT</p> <p>ENERGY</p> <p>FUMAGALLI H.LED.HIP.4K</p> <p>A B C D E F G</p> <p>48 kWh/1000h</p> <p>COMPLY WITH: EU 2019/2015 EU 2019/2020</p> <p>TUV SUD</p> <p>CE LVD CB EMC ERP</p> <p>IECEE CB SCHEME</p> <p>IECEE CB CERTIFICATE: SG PSB-LE-01707 SG PSB-LE-01705</p>			
VOLTAGE	100-240 V		100-240 V	
FREQUENCY	50/60 Hz		50/60 Hz	
DISPLACEMENT FACTOR	>0,9		>0,9	
PSTLM (NO FLICKER)	<1		<1	
SVM	0,4		0,4	
CRI	> 80		> 80	
SWITCHING CYCLE	30.000		30.000	
WARM UP TIME	< 1"		< 0,5"	
LIFETIME	25.000 h		25.000 h	
KELVIN	3000 K	4000 K	3000 K	4000 K
EFFICIENCY CLASS	E	E	E	E
REF. CODE	H.LED.HIP.3K	H.LED.HIP.4K	H4.LED.HIP.3K	H4.LED.HIP.4K

GU10 LED - CCT SETTABLE

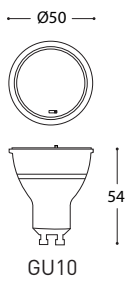
 <p>90% savings =35W halogen</p>	POWER	3,5 W	
	LUMINOUS FLUX (Φ TOTAL)	2700 K	329 lm
		4000 K	366 lm
 <p>SIZE & SOCKET</p> <p>GU10</p>	LUMINOUS FLUX (Φ USE 90°)	260 lm	
	VOLTAGE	100-240 V	
<p>CCT SETTABLE</p> <p>2700 K 4000 K</p> <p>SDCM <3</p> <p>SILICONE PROTECTION DRIVER</p> <p>INDOOR & OUTDOOR USE</p> <p>-30 +80 °C 90% HUMIDITY</p> <p>VOLTAGE SURGE RESISTANT</p>	FREQUENCY	50/60 Hz	
	DISPLACEMENT FACTOR	>0	
<p>ENERGY</p> <p>FUMAGALLI S.R.L. H2 LED GU10 CCT</p> <p>A B C D E F G</p> <p>4 kWh/1000h</p> <p>2019/2020</p> <p>COMPLY WITH: EU 2019/2015 EU 2019/2020</p>	PSTLM (NO FLICKER)	<1	
	SVM	0,4	
<p>TUV SUD</p> <p>CE LVD</p> <p>CB EMC</p> <p>ERP</p> <p>IECEE CB SCHEME</p> <p>IECEE CB CERTIFICATE: SG PSB-LE-02300A1</p>	CRI	> 80	
	SDCM	<3	
<p>TECEE</p> <p>CB SCHEME</p> <p>IECEE CB CERTIFICATE: SG PSB-LE-02300A1</p>	BEAM ANGLE	43°	
	SWITCHING CYCLE	> 25.000	
<p>REF. CODE</p> <p>H.LED.GU10.CCT</p>	WARM UP TIME	≤ 0,5"	
	LIFETIME	25.000 h	

GU10 LED - CCT SETTABLE

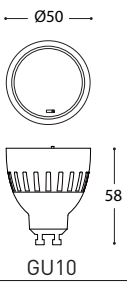
 <p>88% savings =50W halogen</p>	POWER	6 W	
	LUMINOUS FLUX (Φ TOTAL)	2700 K	562 lm
		4000 K	615 lm
 <p>SIZE & SOCKET</p> <p>GU10</p>	LUMINOUS FLUX (Φ USE 90°)	440 lm	
	VOLTAGE	100-240 V	
<p>CCT SETTABLE</p> <p>2700 K 4000 K</p> <p>SDCM <3</p> <p>SILICONE PROTECTION DRIVER</p> <p>INDOOR & OUTDOOR USE</p> <p>-30 +80 °C 90% HUMIDITY</p> <p>VOLTAGE SURGE RESISTANT</p>	FREQUENCY	50/60 Hz	
	DISPLACEMENT FACTOR	>0,5	
<p>ENERGY</p> <p>FUMAGALLI S.R.L. H2 LED GU10 CCT</p> <p>A B C D E F G</p> <p>6 kWh/1000h</p> <p>2019/2020</p> <p>COMPLY WITH: EU 2019/2015 EU 2019/2020</p>	PSTLM (NO FLICKER)	<1	
	SVM	0,9	
<p>TUV SUD</p> <p>CE LVD</p> <p>CB EMC</p> <p>ERP</p> <p>IECEE CB SCHEME</p> <p>IECEE CB CERTIFICATE: SG PSB-LE-02300A1</p>	CRI	> 80	
	SDCM	<3	
<p>TECEE</p> <p>CB SCHEME</p> <p>IECEE CB CERTIFICATE: SG PSB-LE-02300A1</p>	BEAM ANGLE	45°	
	SWITCHING CYCLE	> 25.000	
<p>REF. CODE</p> <p>H2.LED.GU10.CCT</p>	WARM UP TIME	≤ 0,5"	
	LIFETIME	25.000 h	

4 NEWS
16 BOLLARD
34 UP&DOWN
44 FLOODLIGHT
54 IN-GROUND
60 BRICKLIGHT
70 BULKHEAD
88 POST
92 LAMPS

GX53 LED Ø75mm- CCT SETTABLE





	POWER		3 W
	LUMINOUS FLUX (Φ TOTAL)	3000 K	405 lm
		4000 K	410 lm
6500 K		410 lm	
SIZE & SOCKET	<p>GX53</p>		
<p>CCT SETTABLE</p> <p>SDCM <6</p> <p>3000 K 4000 K 6500 K</p> <p>ENERG+</p> <p>FUMAGALLI S.R.L. H.LED.G53.CCT(V)</p> <p>A B C D E F G</p> <p>3 kWh/1000h</p> <p>COMPLY WITH: EU 2019/2015 EU 2019/2020</p> <p>TUV SUD</p> <p>CE LVD CB EMC ERP</p> <p>IECEE</p> <p>IECEE CB CERTIFICATE: SG PSB-LE-01706</p>	LUMINOUS FLUX (Φ USE 120°)	335 lm	
	VOLTAGE	100-240 V	
	FREQUENCY	50/60 Hz	
	PSTLM (NO FLICKER)	<1	
	SVM	0,4	
	CRI	> 80	
	SDCM	<6	
	BEAM ANGLE	112°	
	SWITCHING CYCLE	> 30.000	
	WARM UP TIME	0s	
	LIFETIME	25.000 h	
	EFFICIENCY CLASS	E	
	REF. CODE	H.LED.G53.CCT	

GX53 LED Ø100mm - CCT SETTABLE





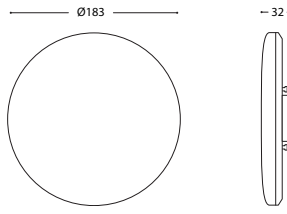
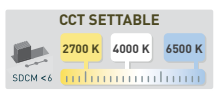
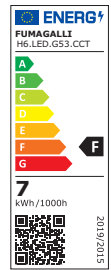
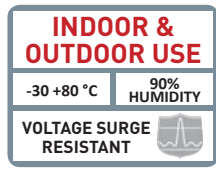

	POWER		7W*	10W
	LUMINOUS FLUX (Φ TOTAL)	3000 K	975 lm	1190 lm
		4000 K	975 lm	1290 lm
6500 K		975 lm	1210 lm	
SIZE & SOCKET	<p>GX53</p>			
<p>CCT SETTABLE</p> <p>SDCM <6</p> <p>3000 K 4000 K 6500 K</p> <p>ENERG+</p> <p>FUMAGALLI S.R.L. H.LED.G53.CCT</p> <p>A B C D E F G</p> <p>10 kWh/1000h</p> <p>COMPLY WITH: EU 2019/2015 EU 2019/2020</p> <p>TUV SUD</p> <p>CE LVD CB EMC ERP</p> <p>IECEE</p> <p>IECEE CB CERTIFICATE: SG PSB-LE-01709</p>	LUMINOUS FLUX (Φ USE 120°)	800 lm	975 lm	
	VOLTAGE	100-240 V	100-240 V	
	FREQUENCY	50/60 Hz	50/60 Hz	
	DISPLACEMENT FACTOR	>0,5	>0,5	
	PSTLM (NO FLICKER)	<1	< 1	
	SVM	0,9	0,4	
	CRI	> 80	> 80	
	SDCM	<6	<6	
	BEAM ANGLE	112°	112°	
	SWITCHING CYCLE	> 30.000	> 30.000	
	WARM UP TIME	0s	0s	
	LIFETIME	25.000 h	25.000 h	
	EFFICIENCY CLASS	E	E	
REF. CODE	H2.LED.G53.CCT	H3.LED.G53.CCT		

* available while stock last

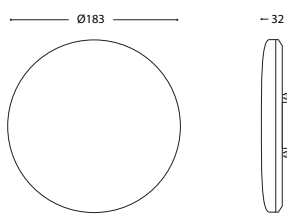
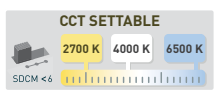

GX53 LED Ø180mm- CCT SETTABLE

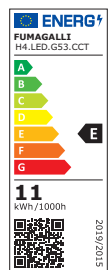
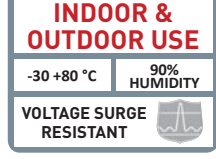
 	POWER	7 W	
	LUMINOUS FLUX (Φ TOTAL)	2700 K	790 lm
		4000 K	851 lm
6500 K		887 lm	
SIZE & SOCKET	 <p>GX53</p>		
 <p>CCT SETTABLE 2700 K 4000 K 6500 K SDCM <6</p>  <p>ENERGY 7 FUMAGALLI H6.LED.G53.CCT 7 kWh/1000h 2019/2015</p> <p>COMPLY WITH: EU 2019/2015 EU 2019/2020</p>  <p>INDOOR & OUTDOOR USE -30 +80 °C 90% HUMIDITY VOLTAGE SURGE RESISTANT</p>	 <p>LVD EMC ERP</p>  <p>IECEE CB CERTIFICATE: SG PSB-LE-01713</p>	LUMINOUS FLUX (Φ USE 120°) 650 lm VOLTAGE 100-240 V FREQUENCY 50/60 Hz DISPLACEMENT FACTOR >0,5 PSTLM (NO FLICKER) <1 SVM 0,9 CRI > 80 SDCM <6 BEAM ANGLE (FWHM) 107° SWITCHING CYCLE > 30.000 WARM UP TIME ≤ 0,5" LIFETIME 25.000 h EFFICIENCY CLASS F REF. CODE H6.LED.G53.CCT	

GX53 LED Ø180mm- CCT SETTABLE

 	POWER	11 W	18 W	
	LUMINOUS FLUX (Φ TOTAL)	2700 K	1325 lm	2118 lm
		4000 K	1446 lm	2315 lm
6500 K		1470 lm	2340 lm	
SIZE & SOCKET	 <p>GX53</p>			
 <p>CCT SETTABLE 2700 K 4000 K 6500 K SDCM <6</p>  <p>SILICONE PROTECTION DRIVER</p>  <p>ENERGY 11 FUMAGALLI H4.LED.G53.CCT 11 kWh/1000h 2019/2015</p> <p>COMPLY WITH: EU 2019/2015 EU 2019/2020</p>  <p>INDOOR & OUTDOOR USE -30 +80 °C 90% HUMIDITY VOLTAGE SURGE RESISTANT</p>	 <p>LVD EMC ERP</p>  <p>IECEE CB CERTIFICATE: SG PSB-LE-01704</p>	LUMINOUS FLUX (Φ USE 120°) 1100 lm 1720 lm VOLTAGE 100-240 V 100-240 V FREQUENCY 50/60 Hz 50/60 Hz DISPLACEMENT FACTOR >0,7 >0,7 PSTLM (NO FLICKER) <1 <1 SVM 0,9 0,9 CRI > 80 > 80 SDCM <6 <6 BEAM ANGLE (FWHM) 107° 107° SWITCHING CYCLE > 25.000 > 25.000 WARM UP TIME ≤ 0,5" ≤ 0,5" LIFETIME 25.000 h 25.000 h EFFICIENCY CLASS E E REF. CODE H4.LED.G53.CCT H5.LED.G53.CCT		

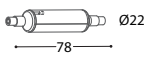
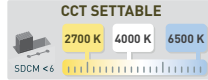
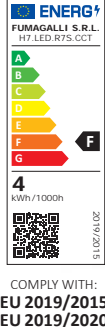
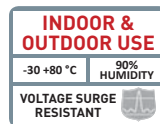
R7s LED 78mm- CCT SETTABLE



SIZE & SOCKET	R7s 	POWER	3,5W
		LUMINOUS FLUX (Φ TOTAL)	2700 K: 325 lm
		4000 K: 365 lm	
		6500 K: 365 lm	
 		VOLTAGE	100-240 V
		FREQUENCY	50/60 Hz
		DISPLACEMENT FACTOR	>0
		PSTLM (NO FLICKER)	<1
		SVM	0,4
		CRI	> 80
		SDCM	<6
		SWITCHING CYCLE	45.000
		WARM UP TIME	≤ 0,5"
		LIFETIME	25.000 h
		EFFICIENCY CLASS	F
		REF. CODE	H7.LED.R7S.CCT

R7s LED 118mm- CCT SETTABLE

SIZE & SOCKET	R7s 	POWER	7,5 W
		LUMINOUS FLUX (Φ TOTAL)	2700 K: 680 lm
		4000 K: 775 lm	
		6500 K: 790 lm	
 		VOLTAGE	100-240 V
		FREQUENCY	50/60 Hz
		DISPLACEMENT FACTOR	>0,5
		PSTLM (NO FLICKER)	<1
		SVM	0,4
		CRI	> 80
		SDCM	<6
		SWITCHING CYCLE	45.000
		WARM UP TIME	≤ 0,5"
		LIFETIME	25.000 h
		EFFICIENCY CLASS	F
		REF. CODE	H8.LED.R7S.CCT

R7s LED 189mm- CCT SETTABLE

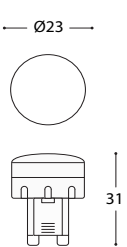
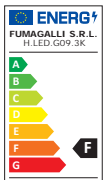
SIZE & SOCKET	R7s 	POWER	10,5 W
		LUMINOUS FLUX (Φ TOTAL)	2700 K: 1000 lm
		4000 K: 1130 lm	
		6500 K: 1160 lm	
 		VOLTAGE	100-240 V
		FREQUENCY	50/60 Hz
		DISPLACEMENT FACTOR	>0,7
		PSTLM (NO FLICKER)	<1
		SVM	0,4
		CRI	> 80
		SDCM	<6
		SWITCHING CYCLE	45.000
		WARM UP TIME	≤ 0,5"
		LIFETIME	25.000 h
		EFFICIENCY CLASS	F
		REF. CODE	H9.LED.R7S.CCT

G9LED		
	POWER	1,7 W
	LUMINOUS FLUX (Φ TOTAL)	3000 K: 150 lm 4000 K: 150 lm
SIZE & SOCKET		
 <p>INDOOR & OUTDOOR USE</p> <p>-30 +80 °C 90% HUMIDITY</p> <p>VOLTAGE SURGE RESISTANT</p>   <p>COMPLY WITH: EU 2019/2015 EU 2019/2020</p> <p>IECEE CB CERTIFICATE: SG PSB-LE-02130</p>	VOLTAGE	100-240 V
	FREQUENCY	50/60 Hz
	PSTLM (NO FLICKER)	<1
	SVM	0,9
	CRI	> 80
	SDCM	<6
	SWITCHING CYCLE	>40.000
	WARM UP TIME	≤ 0,5"
	LIFETIME	15.000 h
	KELVIN	3000 K
EFFICIENCY CLASS	F	F
REF. CODE	H.LED.G09.3K	H.LED.G09.4K

SOLAR MODULE - CCT SETTABLE			
 <p>SOLAR</p> <p>≥12 Hours</p> <p>CE, CB, LVD, EMC, ERP</p> <p>IECEE CB CERTIFICATE: SG PSB-LE-02677</p> <p>CCT SETTABLE SDCM <6</p> <p>3000 K 4000 K 6500 K</p>	SIZE		
	SUMMER MODE	LUMEN	42
		AUTONOMY	25h
	WINTER MODE	LUMEN	20
		AUTONOMY	46h
	SENSORE MODE	LUMEN	280
		ACTIVE TIME	25 sec
		N° Detections	423
	SOLAR PANEL	5V/2W	
		Monocrystalline PET type	
CHARGING TIME	Antishock material		
	6h		
REPLACEABLE BATTERY	LiFePO4 IFR26650 3,3Ah, 3,2V		
	No Risk of explosion		
	Working temperature -10° to +60°C		
	Longer Lifetime		
PIR SENSOR	Detection angle 120°		
	Fields of detection up to 5 mt		
	Active for 25 sec.		
LED	3 CIRCUITS	SMD 3528	
	COLOR RENDERING INDEX RA	> 80	
	SDCM	< 6	
	LIFETIME	30.000 h	
	KELVIN SETTABLE	3000 K / 4000 K / 6500 K	
REF. CODE	H.LED.SOL.CCT		

LOOKING FOR SOMETHING ELSE?

See all our **Top selection brochures 2022!**



TO SEE OUR COMPLETE COLLECTION

Ask for our
General Catalogue 2023
or visit our website at
www.fumagalli.it



RESIN MATERIAL ADVANTAGES



NO MAINTENANCE



ANTI-CORROSION



DOUBLE INSULATION



NOT AFFECTED BY CHEMICAL FERTILIZERS



UV-RAY STABILIZED



RECYCLABLE



UV TREATED

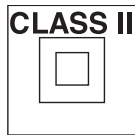

DOUBLE INSULATION



ANTI-SHOCK

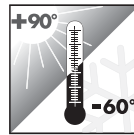

TEMPERATURE

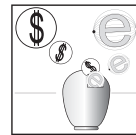

ENERGY SAVING

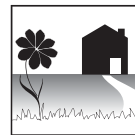

RESIDENTIAL



PUBLIC

HOW TO READ THE CODE

DIFFUSER
IDENTIFIES THE DIFFUSER

1 R 3

STRUCTURE
IDENTIFIES THE STRUCTURE ON WHICH THE DIFFUSER IS MOUNTED (POLE, BRACKET, BASE, SPIKE)

6 1 3

SYSTEM
IDENTIFIES THE MULTILIGHT SYSTEM IF PRESENT

X 2 0

COLOUR OF THE STRUCTURE
IDENTIFIES THE COLOUR OF THE STRUCTURE

A BLACK
W WHITE
L GREY

A

COLOUR OF THE DIFFUSER
IDENTIFIES THE COLOUR OF THE DIFFUSER

X CLEAR/FROSTED
Y OPAL
Z SMOKED
N GREEN
R ORANGE
U BLUE

Y

ELECTRIFICATION
IDENTIFIES THE TYPE OF ELECTRIFICATION AND THE EVENTUAL PRESENCE OF BULBS

B 1 L

VARIANT
IDENTIFIES THE PRESENCE OF COMPONENTS SUCH AS AN EVENTUAL LOUVRE OR BACKLIT BASE ON THE BULKHEAD RANGE

O R 1



fumagalli[®]
s i n c e 1 9 7 3

Fumagalli S.r.l.
Via Ca' Bassa, 29
21100 Varese - ITALY
Tel. +39.0332.336353
Fax. +39.0332.336358
E-mail italian.lux@fumagalli.it



www.fumagalli.it



NEW



WARM Light **DAY Light** **COLD Light**

KELVIN SETTABLE LAMP

