

RANGE CATALOGUE

DX³

THE NEXT STEP

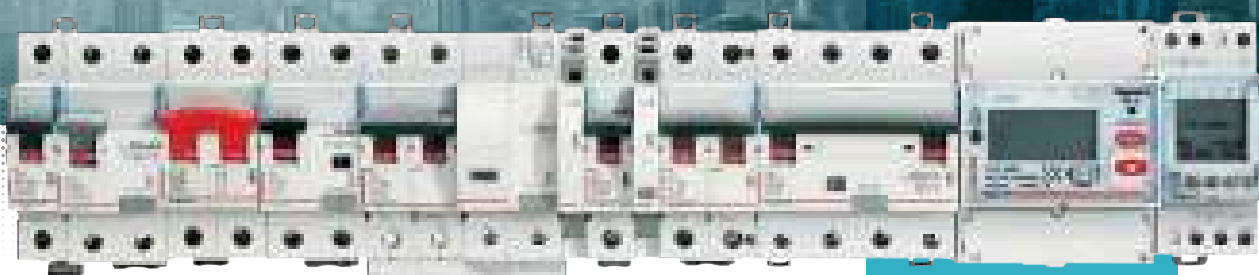

THE GLOBAL SPECIALIST
IN ELECTRICAL AND DIGITAL BUILDING INFRASTRUCTURES

 **legrand**[®]

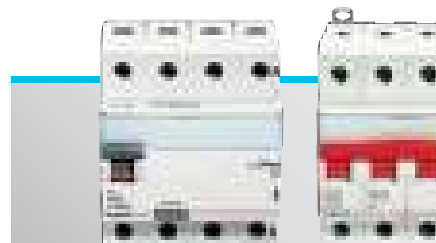

2-3

Introduction

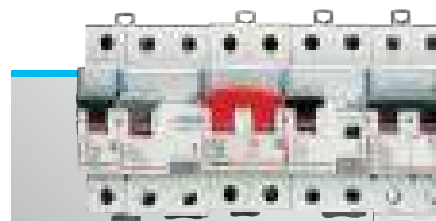

4-5

Legrand, a clear, comprehensive offer for all types of application



6-7

DX³, a complete solution

DX³

THE NEXT STEP

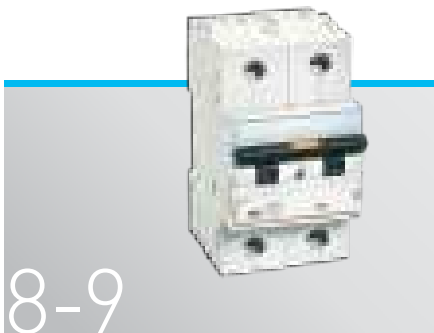

8-9

Easy, safe connection



14

Protection tailored to your requirements

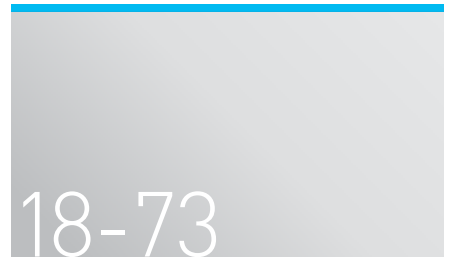

18-73

Catalogue pages

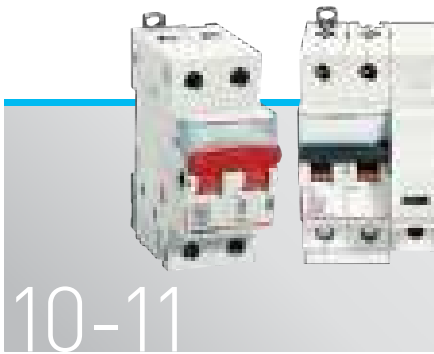

10-11

DX³, impeccable quality

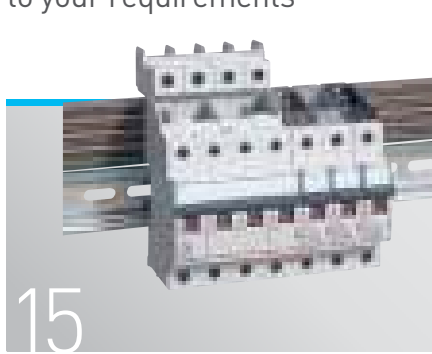

15

Choose your distribution



12-13

Perfect control of your installation



16-17

More comfort with energy saving



A company always known for its groundbreaking innovations, Legrand's extensive R&D and technologically advanced products make us who we are today. As the global specialist in electrical and digital building infrastructures, our understanding of the market and its needs motivate us to innovate. Your recognition of our efforts, led us to the next step - DX³.

DX³

Presenting, DX³, an international range of protection devices. Its revolutionary design supports all kinds of installations thus giving a never before experience. With 10 patents, 13 new features and a wide range, DX³ is the next step.



LEGRAND, A CLEAR, COMPREHENSIVE OFFER FOR ALL TYPES OF APPLICATION

The new DX³ circuit breakers can be integrated with a wide range of products, providing exceptional technical performance levels

The variety of functions and range of characteristics offered will enable you to equip all your distribution boards. The very high levels of coordination between the various ranges of DX³ modular circuit breakers makes it suitable for all types of application.

PROTECTION / BREAKING

MEASUREMENT

CONTROL



All functions on DIN rail



Each breaking capacity has its own power solution

Perfect complementarity for your distribution boards up to 6300 A and 100 kA breaking capacity.



DX³



DPX³



DMX³

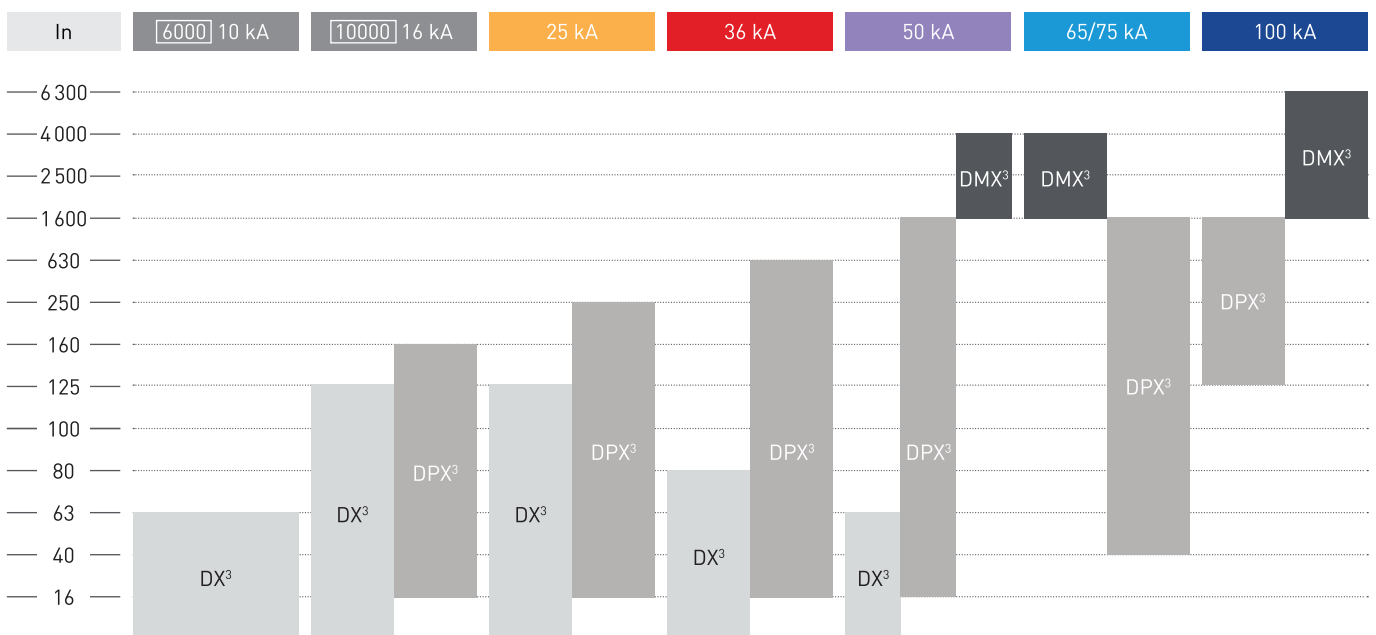



DX³ A COMPLETE SOLUTION

The efficient designs of the products are such that they can be easily installed. The clear identification marks, to know the state of the circuit breaker, make it easier to maintain. The high quality products also assure the safety of the user, thus making it a complete solution.

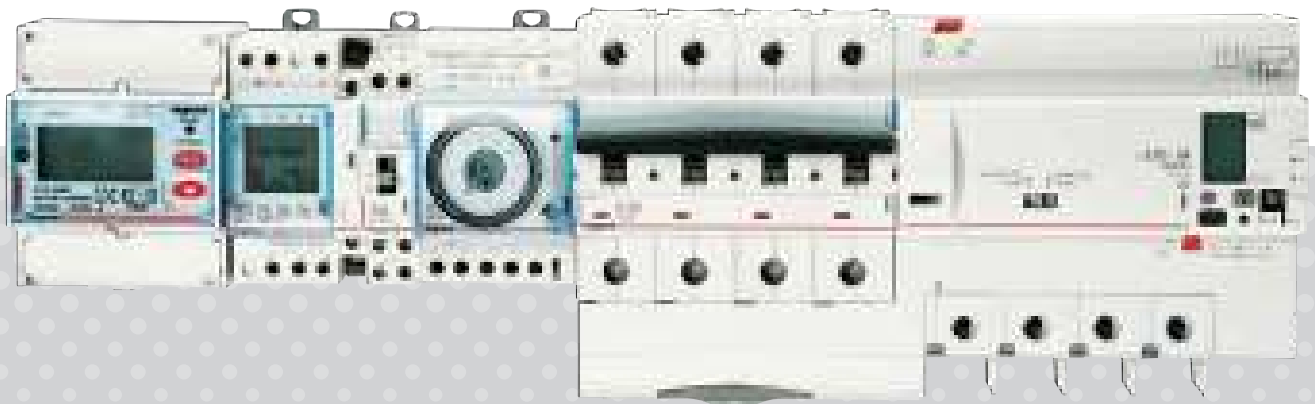



COPYTRACER, THE FIGHT AGAINST COUNTERFEITING
 Copytracer is a unique registration number that is marked on some of our products. The number is stored in a database. Go to the website: www.legrand-copytracer.com

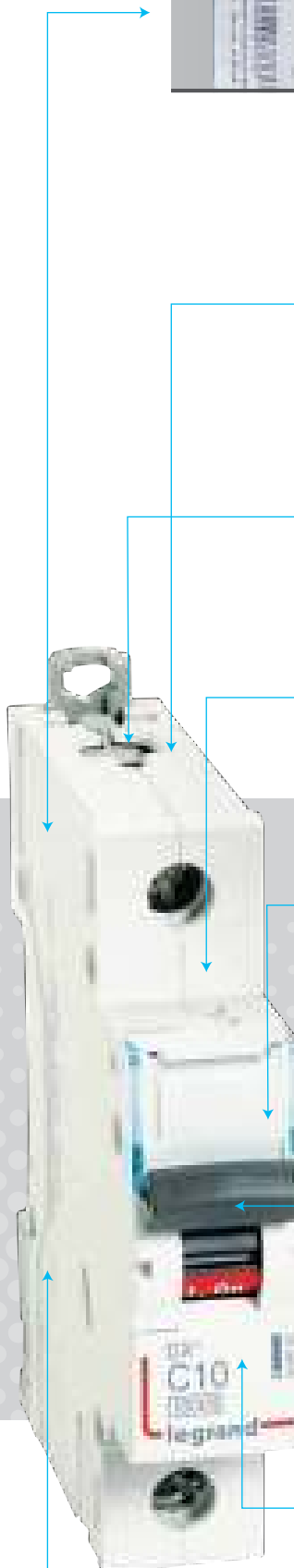

Sliding shutters



New top clamp for all tools



Technical labelling area

F10A

Integrated label holder

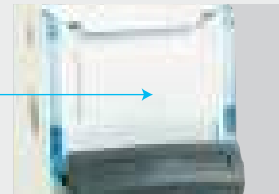

Colour coded handle with ON/OFF colour indication

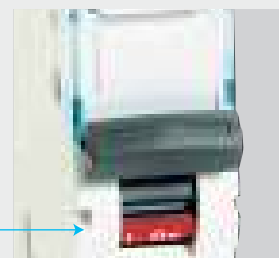

Environment friendly



Improved air channels

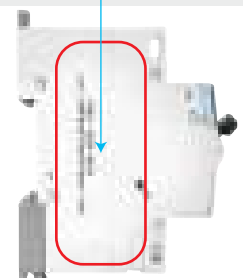

Bottom clamp

EASY, SAFE CONNECTION



Safety is
prioritised with
the innovative
features of the
DX³ products

The quality and hold of the connections are vital for the safety of distribution boards fitted with high breaking capacity MCBs. The connection areas are designed to make installation faster without compromising on safety.

RISING CLAMP TERMINALS
Ensure a high quality, durable connection

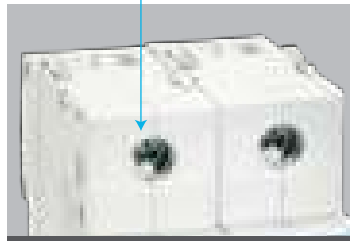

RELIABLE CONNECTIONS
Compensation for the effect of loosening to ensure excellent hold over time and consistent contact ($I_n \geq 80 A$)

Temperature rise
-20%

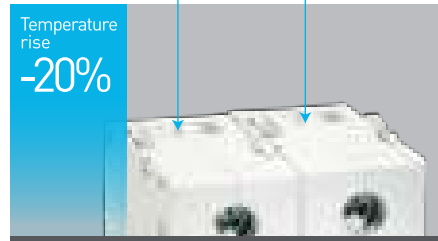

1.5
modules/pole

Black handle: circuit breakers
Grey handle: switches

Breaking capacity
■ 16 kA
■ 25 kA
■ 36 kA
■ 50 kA

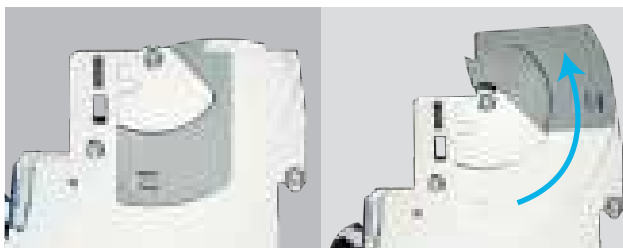

RETRACTABLE INSULATING SHIELDS

With the integrated retractable insulating shields, no additional accessories are needed to isolate the connections on any breaking capacities and high ratings of the 1.5 modules/pole ($I_n \leq 63 A$) circuit breakers.

DX³ IMPECCABLE QUALITY



Legrand pays particular attention to how these devices perform: Each of them is set and checked individually on the production lines

The design integrated with the DX³ range implicates its international quality. The products are crafted in a way to provide ease of installation.

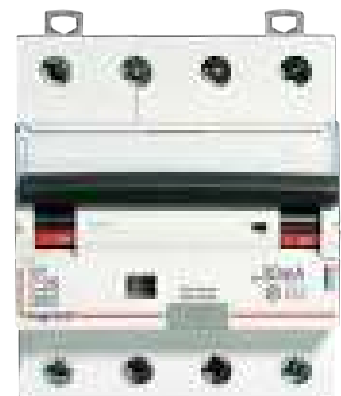

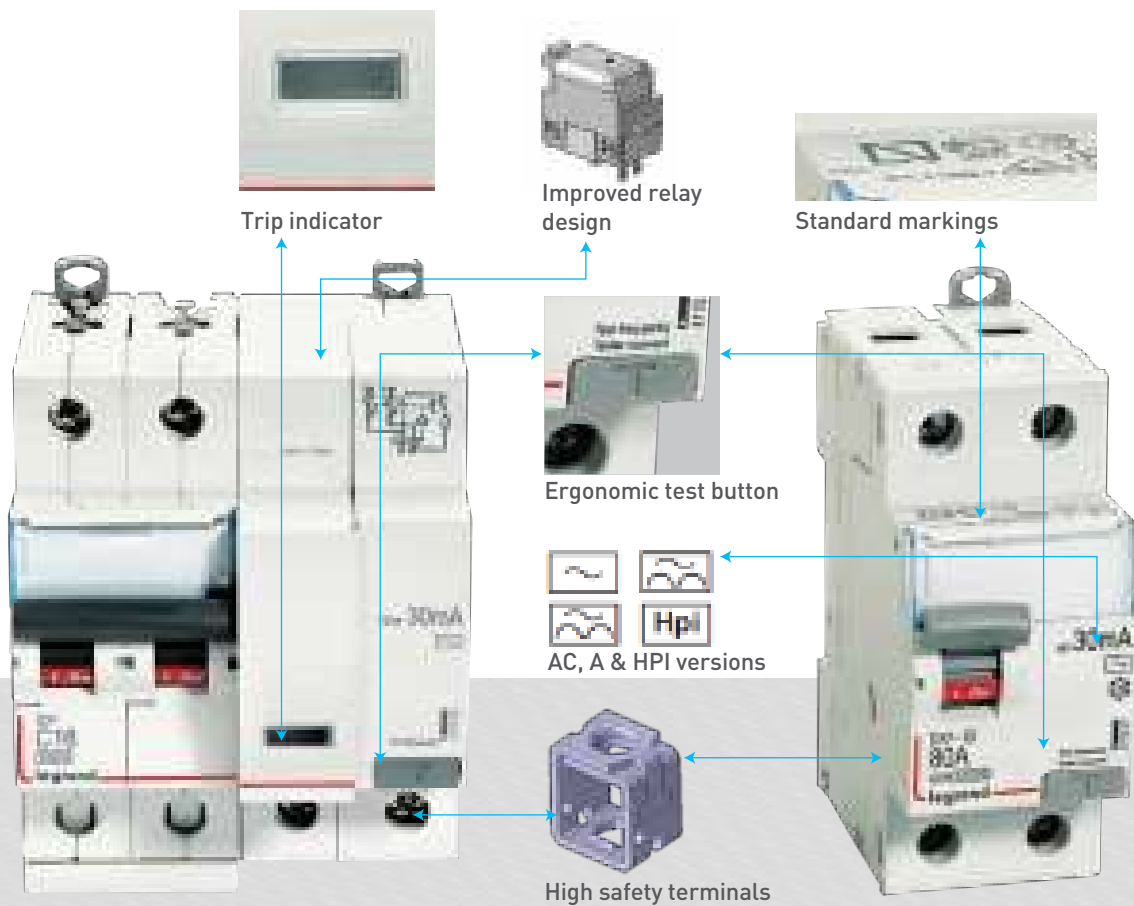
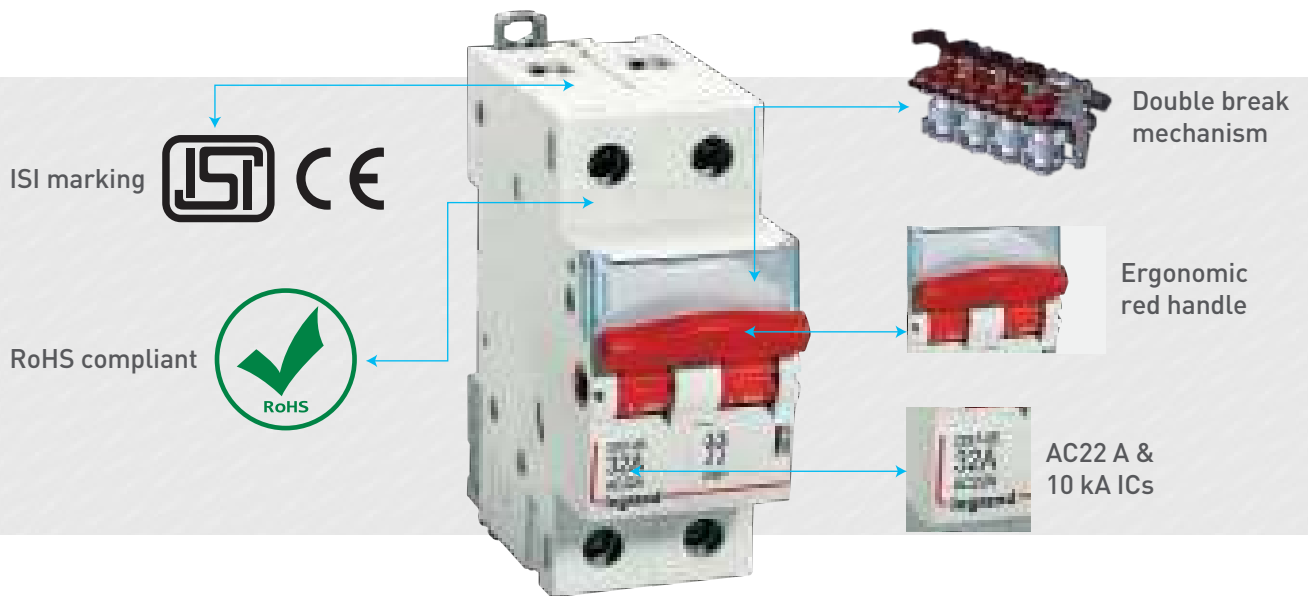

PERFECT CONTROL OF YOUR INSTALLATION



The DX³ range
has a selection
of electrical
auxiliaries
for monitoring
and controlling
circuits remotely

Auxiliary contacts and fault
signal contacts, shunt trips,
undervoltage releases,
overvoltage releases and
motorised controls.



THE AUXILIARIES FIT FIRMLY
without the need for any tools and
ensures that the entire assembly is robust

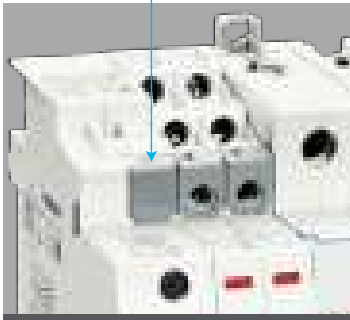

THE ACCESSIBILITY OF THE TERMINALS
and the visibility of the screw heads
make the installer's work easier

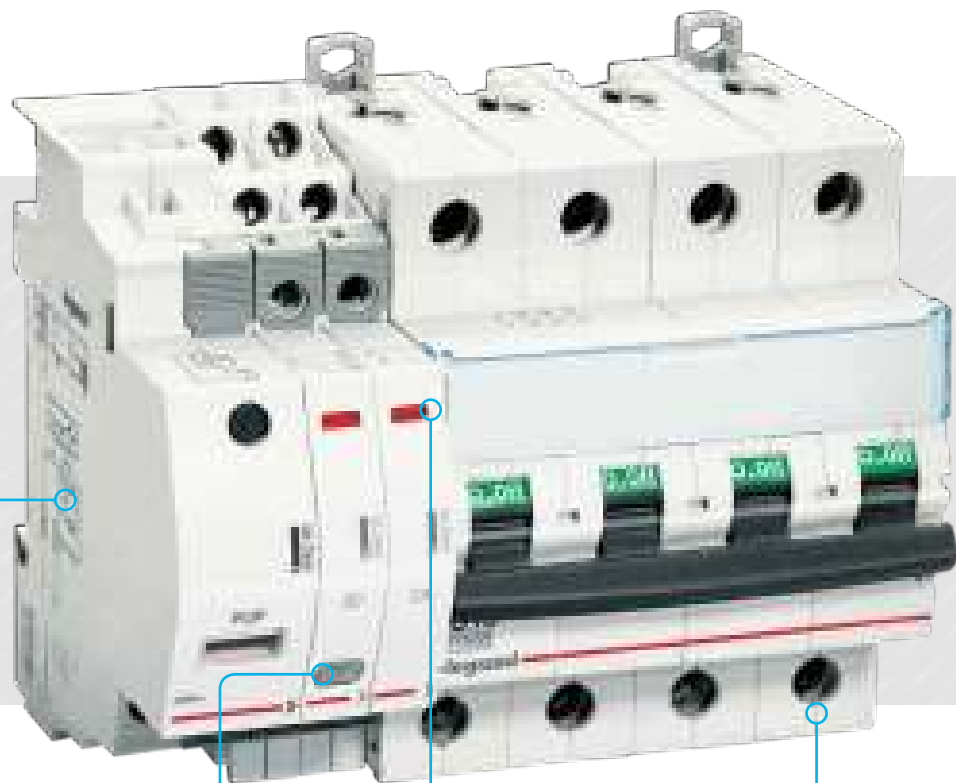
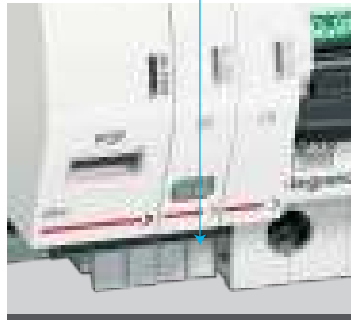

Marking of auxiliaries
(characteristics,
connection, mounting)

The fault signal
contacts have a
test button

The colour code of the indicators
on the signalling auxiliaries is
the same as that
of the remote indicators

DX³ circuit breakers take up
to 3 auxiliaries including one
control auxiliary



DX³ motorised controls can be used with 1 module per
pole devices (circuit breakers, RCBOs and RCCBs)
just as easily as auxiliaries.

OPTIMISED SPACE IN THE DISTRIBUTION BOARD

Legrand motorised controls are the most compact
in the market: 1 module wide.
They save a great deal of space inside the
distribution board.

PROTECTION TAILORED TO YOUR REQUIREMENTS

A compact solution for
protection and measurement

The new DX³ RCD add-on modules with metering have a wide range of features to meet the most stringent safety requirements. They come with RS485 communication port for remote data viewer.

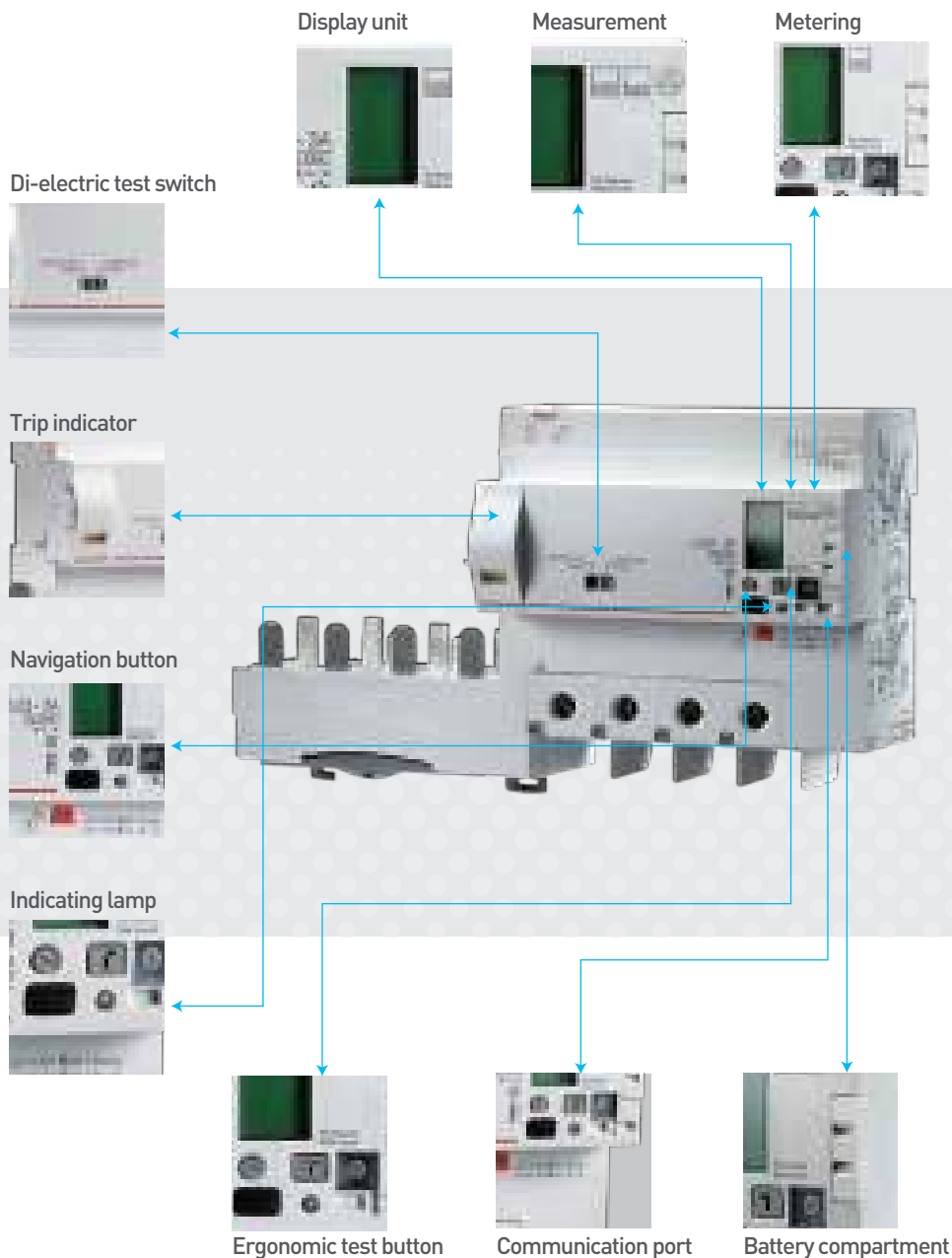

CHOOSE YOUR DISTRIBUTION

Legrand optimised distribution has been designed for maximum safety, ease of installation and maintenance of distribution boards

Wiring and tedious tightening operations are minimised, and the risks of poor contact and short-circuits are reduced, while mounting time is optimised.

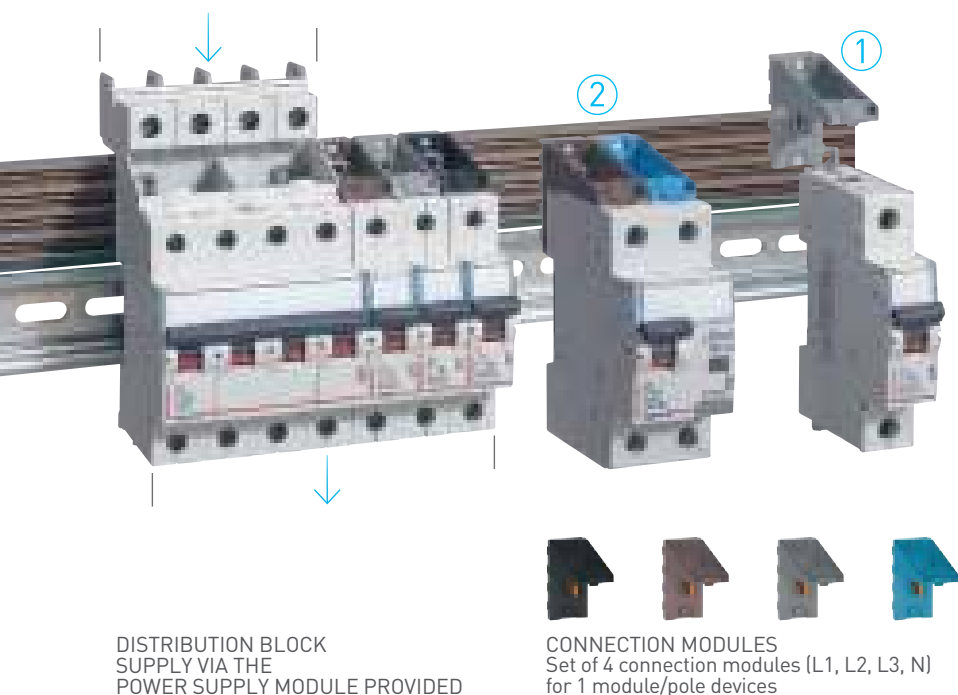

OPTIMISED DISTRIBUTION HX³ 125 A horizontal distribution blocks with plug-in connection

Horizontal 4-pole distribution for XL³ 160 to 4000 enclosures:

- Optimised design: Freedom to mix 1P, 1P+N, 2P, 3P and 4P devices on the same row
- Optimised installation: Automatic connection with no wiring or clamping
- Safe connection and disconnection of devices, even when the distribution block is powered-up (due to the IP xxB insulation of the distribution block and the integral connection modules in the devices).

DISTRIBUTION BLOCK SUPPLY VIA THE POWER SUPPLY MODULE PROVIDED

CONNECTION MODULES Set of 4 connection modules (L1, L2, L3, N) for 1 module/pole devices



DISTRIBUTION BLOCK SUPPLY VIA THE MAIN DEVICE

EASY CONNECTION

Circuit breakers with plug-in terminals are fixed onto the distribution block with no need for any tool. The phase to be connected is determined by the choice of the connector. The distribution block can be supplied via the power supply module provided or via the head of row device.

MORE COMFORT WITH ENERGY SAVINGS



The Legrand modular control and monitoring devices are a perfect addition to the range of DX³ protection devices

With its time switches & contactors, Legrand guarantees a unique experience. With the selection of functions available, it is simple to improve the safety, efficiency and comfort of installations and meet energy requirements.



- Conform to IEC/EN 61095
- Space for power supply busbar on top (up to 25 A)
- Manual override for test and repair functions, carried out via the handle
- Permanent "ON" or "OFF" without automatic reset



- With synchronous (mains- synchronised clock precision) or quartz motor
- +/- 2.5 s/day clock precision (quartz motor)
- 100 hour running reserve (quartz motor)
- Surface-mounting possible with a wall bracket and a terminal cover (cat no : 412859)
- Unit width: 3 modules of 17.5 mm each



DIN RAIL equipment



P. 20-21
DX³ - MCB
AC Application
upto 63 A

MCBs



P. 24
DX³ - 25 kA MCB
from 6 A to 125 A

Isolator RCCB & RCBOs



P. 27
DX³ - Isolator
AC Application
upto 125 A

RCD add-on module & Auxiliaries and other control functions



P. 29
DX³ - RCD
add-on module
for 125 A

CX³ switches, push-buttons and indicators



P. 33
CX³
Changeover switches

EMDX³ electrical energy meters & measuring units



P. 34
EMDX³
electrical energy
meters

DISCOVER THE PRODUCTS



DX³
MCBs
(p. 20)

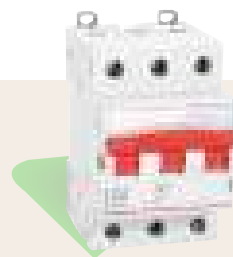

DX³
Isolator
(p. 27)



P. 22
DX³ - MCB
AC Application
from 80-125 A



P. 22
DX³ - MCB
DC Application
upto 63 A



P. 23
DX³ - 16 kA MCB
from 63 A to 125 A



P. 25
DX³ - 36 kA MCB
from 10 A to 80 A



P. 25
DX³ - 50 kA MCBs
from 10 A to 63 A



P. 26
DX³ - photovoltaic
applications and RDSO



P. 27
DX³ - RCCBs
AC Application
upto 63 A



P. 28
DX³ - RCCBs
AC Application
from 80 - 100 A



P. 28
DX³ - RCBOs
AC Application
upto 63 A



P. 29
DX³ - RCBOs - 6 kA
AC Application
upto 32 A



P. 30
DX³
Auxiliaries



P. 31
DX³ - RCD
add-on module with
measurement &
metering



P. 31-32
DX³
time switches



P. 32
Contactor



P. 33
CX³
Push-buttons and
control switches



P. 33
CX³
LED indicators



P. 34
EMDX³
Multi-functions
measuring units



P. 36
Low voltage SPDs
class I (T1)

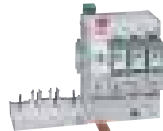

P. 37
Low voltage SPDs
class II (T2)



P. 38
SPDs for
telephone lines



DX³
RCCB & RCBO
(p. 27-29)

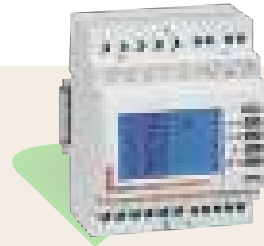

EMDX³
multi-function
measuring units
(p. 34)

DX³ MCBs

MCBs for AC applications till 63 A



Technical characteristics p. 39-53

- 10 kA ISI marked as per IS/IEC 60898-1 2002
- Integrated label holder
- Sliding bottom clamp
- Improved air channels
- Color coded On/Off indication on dolly
- Biconnect lower terminals
- IP 20 protected terminals
- Sliding shutters
- DC-80 V per pole - 1 kA

Pack	Cat.Nos	DX ³ MCBs - C curve	Pack	Cat.Nos	DX ³ MCBs - C curve	
		Single pole 240/415 V~			3 pole 415 V~	
		Nominal rating In (A)			Nominal rating In (A)	
		Number of modules			Number of modules	
1/10/120	4085 80	0.5	1/32	4086 43	0.5	3
1/10/120	4085 81	1	1/32	4086 44	1	3
1/10/120	4085 83	2	1/32	4086 46	2	3
1/10/120	4085 84	3	1/32	4086 47	3	3
1/10/120	4085 85	4	1/32	4086 48	4	3
1/10/120	4085 87	6	1/32	4086 50	6	3
1/10/120	4085 90	10	1/32	4086 53	10	3
1/10/120	4085 92	16	1/32	4086 55	16	3
1/10/120	4085 93	20	1/32	4086 56	20	3
1/10/120	4085 94	25	1/32	4086 57	25	3
1/10/120	4085 95	32	1/32	4086 58	32	3
1/10/120	4085 96	40	1/32	4086 59	40	3
1/10/120	4085 97	50	1/32	4086 60	50	3
1/10/120	4085 98	63	1/32	4086 61	63	3
		Single pole + Neutral 230 V~			3 pole + Neutral 415 V~	
1/5/60	4086 02	0.5	1/32	4086 65	0.5	4
1/5/60	4086 03	1	1/32	4086 66	1	4
1/5/60	4086 05	2	1/32	4086 68	2	4
1/5/60	4086 06	3	1/32	4086 69	3	4
1/5/60	4086 07	4	1/32	4086 70	4	4
1/5/60	4086 09	6	1/32	4086 72	6	4
1/5/60	4086 12	10	1/32	4086 75	10	4
1/5/60	4086 14	16	1/32	4086 77	16	4
1/5/60	4086 15	20	1/32	4086 78	20	4
1/5/60	4086 16	25	1/32	4086 79	25	4
1/5/60	4086 17	32	1/32	4086 80	32	4
1/5/60	4086 18	40	1/32	4086 81	40	4
1/5/60	4086 19	50	1/32	4086 82	50	4
1/5/60	4086 20	63	1/32	4086 83	63	4
		2 pole 415 V~			4 pole 415 V~	
1/40	4086 21	0.5	1/32	4086 84	0.5	4
1/40	4086 22	1	1/32	4086 85	1	4
1/40	4086 24	2	1/32	4086 87	2	4
1/40	4086 25	3	1/32	4086 88	3	4
1/40	4086 26	4	1/32	4086 89	4	4
1/40	4086 28	6	1/32	4086 91	6	4
1/40	4086 31	10	1/32	4086 94	10	4
1/40	4086 33	16	1/32	4086 96	16	4
1/40	4086 34	20	1/32	4086 97	20	4
1/40	4086 35	25	1/32	4086 98	25	4
1/40	4086 36	32	1/32	4086 99	32	4
1/40	4086 37	40	1/32	4087 00	40	4
1/40	4086 38	50	1/32	4087 01	50	4
1/40	4086 39	63	1/32	4087 02	63	4

Bold catalogue numbers are products normally available with Legrand (India) stockists. **Cat.Nos that are not bold** - delivery within 4 - 8 weeks from the date of order. **Bold packing quantity** is our mandatory packing. Orders to be placed by Legrand (India) stockists in multiples of the same.
Red catalogue numbers: New products

DX³ MCBs

MCBs for AC applications till 63 A (continued)



4087 19



4087 46



4087 52

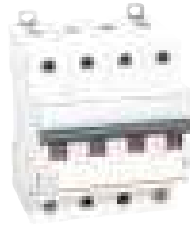

4087 90

Technical characteristics **p. 39-53**

- 10 kA ISI marked as per IS/IEC 60898-1 2002
- Integrated label holder
- Sliding bottom clamp
- Improved air channels
- Color coded On/Off indication on dolly
- Biconnect lower terminals
- IP 20 protected terminals
- Sliding shutters
- DC-80 V per pole - 1 kA

Pack	Cat.Nos	DX ³ MCBs - D curve	Number of modules	Pack	Cat.Nos	DX ³ MCBs - D curve	Number of modules
Single pole 240/415 V~				3 pole 415 V~			
		Nominal rating In (A)				Nominal rating In (A)	
1/10/120	4087 06	0.5	1	1/32	4087 52	0.5	3
1/10/120	4087 07	1	1	1/32	4087 53	1	3
1/10/120	4087 09	2	1	1/32	4087 55	2	3
1/10/120	4087 10	3	1	1/32	4087 56	3	3
1/10/120	4087 11	4	1	1/32	4087 57	4	3
1/10/120	4087 12	6	1	1/32	4087 58	6	3
1/10/120	4087 14	10	1	1/32	4087 60	10	3
1/10/120	4087 16	16	1	1/32	4087 62	16	3
1/10/120	4087 17	20	1	1/32	4087 63	20	3
1/10/120	4087 18	25	1	1/32	4087 64	25	3
1/10/120	4087 19	32	1	1/32	4087 65	32	3
1/10/120	4087 20	40	1	1/32	4087 66	40	3
1/10/120	4087 21	50	1	1/32	4087 67	50	3
1/10/120	4087 22	63	1	1/32	4087 68	63	3
Single pole + Neutral 230 V~				3 pole + Neutral 415 V~			
1/5/60	4087 26	0.5	2	1/32	4087 72	0.5	4
1/5/60	4087 27	1	2	1/32	4087 73	1	4
1/5/60	4087 29	2	2	1/32	4087 75	2	4
1/5/60	4087 30	3	2	1/32	4087 76	3	4
1/5/60	4087 31	4	2	1/32	4087 77	4	4
2 pole 415 V~				4 pole 415 V~			
1/40	4087 32	0.5	2	1/32	4087 78	0.5	4
1/40	4087 33	1	2	1/32	4087 79	1	4
1/40	4087 35	2	2	1/32	4087 81	2	4
1/40	4087 36	3	2	1/32	4087 82	3	4
1/40	4087 37	4	2	1/32	4087 83	4	4
1/40	4087 38	6	2	1/32	4087 84	6	4
1/40	4087 40	10	2	1/32	4087 86	10	4
1/40	4087 42	16	2	1/32	4087 88	16	4
1/40	4087 43	20	2	1/32	4087 89	20	4
1/40	4087 44	25	2	1/32	4087 90	25	4
1/40	4087 45	32	2	1/32	4087 91	32	4
1/40	4087 46	40	2	1/32	4087 92	40	4
1/40	4087 47	50	2	1/32	4087 93	50	4
1/40	4087 48	63	2	1/32	4087 94	63	4

DX³ MCBs

MCBs for AC applications 80 - 125 A



DX³ MCBs

MCBs for DC applications 63 A



4086 00



4086 40



4086 63



4088 12



Technical characteristics p. 39-53

10 kA as per IEC 60947-2
 Integrated label holder
 Sliding insulating shield
 Color coded contact indication window
 IP 20 protected terminals
 50 sq mm terminals

6 kA as per IEC 60947-2
 Integrated label holder
 Sliding bottom clamp
 Improved air channels
 Color coded On/Off indication on dolly
 Biconnect lower terminals
 IP 20 protected terminals
 Sliding shutters

Pack	Cat.Nos	DX ³ MCBs 10 kA*	Number of modules
		Single pole 230 V\sim / 400 V\sim	
		Nominal rating I _n (A)	
1/5/160	4085 99	80	1.5
1/5/161	4086 00	100	1.5
1/5/162	4086 01	125	1.5
		2 pole 400 V\sim	
1/5/60	4086 40	80	3
1/5/60	4086 41	100	3
1/5/60	4086 42	125	3
		3 pole 400 V\sim	
1/9	4086 62	80	4.5
1/9	4086 63	100	4.5
1/9	4086 64	125	4.5
		4 pole 400 V\sim	
1/9	4087 03	80	6
1/9	4087 04	100	6
1/9	4087 05	125	6

*For industrial use only.

Pack	Cat.Nos	DX ³ MCBs 6 kA*	Number of modules
		Single pole 250 V\equiv	
		Nominal rating I _n (A)	
1/10/120	4087 98	0.5	1
1/10/120	4087 99	1	1
1/10/120	4088 01	2	1
1/10/120	4088 02	3	1
1/10/120	4088 03	4	1
1/10/120	4088 04	6	1
1/10/120	4088 06	10	1
1/10/120	4088 08	16	1
1/10/120	4088 09	20	1
1/10/120	4088 10	25	1
1/10/120	4088 11	32	1
1/10/120	4088 12	40	1
1/10/120	4088 13	50	1
1/10/120	4088 14	63	1
		2 pole 500 V\equiv	
1/5/60	4088 15	0.5	2
1/5/60	4088 16	1	2
1/5/60	4088 18	2	2
1/5/60	4088 19	3	2
1/5/60	4088 20	4	2
1/5/60	4088 21	6	2
1/5/60	4088 23	10	2
1/5/60	4088 25	16	2
1/5/60	4088 26	20	2
1/5/60	4088 27	25	2
1/5/60	4088 28	32	2
1/5/60	4088 29	40	2
1/5/60	4088 30	50	2
1/5/60	4088 31	63	2

*For industrial use only.

DX³ MCBs - 16 kA

thermal magnetic MCB from 6 A to 125 A



4092 25

Technical characteristics p. 39-53

Breaking capacity
16 kA - IEC 60947-2 - 400 V~
Can be equipped with DX³ auxiliaries and accessories

Pack	Cat.Nos	DX ³ MCBs 16 kA*		Pack	Cat.Nos	DX ³ MCBs 16 kA*	
		Single pole 230/400 V~				3 pole 400 V~	
		Nominal rating I _n (A)	Number of modules			Nominal rating I _n (A)	Number of modules
1	4091 29	6	1	1	4092 69	6	3
1	4091 31	10	1	1	4092 71	10	3
1	4091 32	13	1	1	4092 72	13	3
1	4091 33	16	1	1	4092 73	16	3
1	4091 34	20	1	1	4092 74	20	3
1	4091 35	25	1	1	4092 75	25	3
1	4091 36	32	1.5	1	4092 76	32	4.5
1	4091 37	40	1.5	1	4092 77	40	4.5
1	4091 38	50	1.5	1	4092 78	50	4.5
1	4091 39	63	1.5	1	4092 79	63	4.5
1	4091 40	80	1.5	1	4092 80	80	4.5
1	4091 41	100	1.5	1	4092 81	100	4.5
1	4091 42	125	1.5	1	4092 82	125	4.5
		2 pole 230/400 V~				4 pole 400 V~	
1	4092 17	6	2	1	4093 51	6	4
1	4092 19	10	2	1	4093 53	10	4
1	4092 20	13	2	1	4093 54	13	4
1	4092 21	16	2	1	4093 55	16	4
1	4092 22	20	2	1	4093 56	20	4
1	4092 23	25	2	1	4093 57	25	4
1	4092 24	32	2	1	4093 58	32	6
1	4092 25	40	3	1	4093 59	40	6
1	4092 26	50	3	1	4093 60	50	6
1	4092 27	63	3	1	4093 61	63	6
1	4092 28	80	3	1	4093 62	80	6
1	4092 29	100	3	1	4093 63	100	6
1	4092 30	125	3	1	4093 64	125	6

*For industrial use only.

*For industrial use only.

DX³ MCBs - 25 kA

thermal magnetic MCBs from 6 A to 125 A

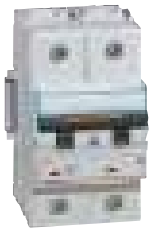

4097 72



4098 03

Technical characteristics **p. 39-53**

Breaking capacity:
25 kA - IEC 60947-2 - 400 V~
Can be equipped with DX³ auxiliaries and accessories

Pack	Cat.Nos	DX³ MCBs - 25 kA*	
		Single pole 230/400 V~	
		C curve	Number of modules
		Nominal rating I _n (A)	
1	4097 53	6	1
1	4097 54	10	1
1	4097 55	16	1
1	4097 56	20	1
1	4097 57	25	1
1	4097 58	32	1.5
1	4097 59	40	1.5
1	4097 60	50	1.5
1	4097 61	63	1.5
1	4097 62	80	1.5
1	4097 63	100	1.5
1	4097 64	125	1.5
		2 pole - 230/400 V~	
1	4097 66	6	2
1	4097 67	10	2
1	4097 68	16	2
1	4097 69	20	2
1	4097 70	25	2
1	4097 71	32	2
1	4097 72	40	3
1	4097 73	50	3
1	4097 74	63	3
1	4097 75	80	3
1	4097 76	100	3
1	4097 77	125	3

*For industrial use only.

Pack	Cat.Nos	DX³ MCBs - 25 kA* (continued)	
		3 pole - 400 V~	
		C curve	Number of modules
		Nominal rating I _n (A)	
1	4097 79	6	3
1	4097 80	10	3
1	4097 81	16	3
1	4097 82	20	3
1	4097 83	25	3
1	4097 84	32	4.5
1	4097 85	40	4.5
1	4097 86	50	4.5
1	4097 87	63	4.5
1	4097 88	80	4.5
1	4097 89	100	4.5
1	4097 90	125	4.5
		4 pole - 400 V~	
1	4097 92	6	4
1	4097 93	10	4
1	4097 94	16	4
1	4097 95	20	4
1	4097 96	25	4
1	4097 97	32	6
1	4097 98	40	6
1	4097 99	50	6
1	4098 00	63	6
1	4098 01	80	6
1	4098 02	100	6
1	4098 03	125	6

*For industrial use only.

DX³ MCBs - 36 kA

thermal magnetic MCBs from 10 A to 80 A



4100 12

4100 27

Red marking = 36 kA

Technical characteristics p. 39-53

Breaking capacity:
36 kA - IEC 60947-2 - 400 V \sim
Can be equipped with DX³ auxiliaries and accessories

Pack	Cat.Nos	DX ³ MCBs - 36 kA*	
		2 pole - 400 V\sim	
	C curve	Nominal rating In (A)	Number of modules
1	4100 07	10	1.5
1	4100 08	16	1.5
1	4100 09	20	1.5
1	4100 10	25	1.5
1	4100 11	32	1.5
1	4100 12	40	1.5
1	4100 13	50	1.5
1	4100 14	63	1.5
1	4100 15	80	1.5
		3 pole - 400 V\sim	
1	4100 20	10	4.5
1	4100 21	16	4.5
1	4100 22	20	4.5
1	4100 23	25	4.5
1	4100 24	32	4.5
1	4100 25	40	4.5
1	4100 26	50	4.5
1	4100 27	63	4.5
1	4100 28	80	4.5
		4 pole - 400 V\sim	
1	4100 33	10	6
1	4100 34	16	6
1	4100 35	20	6
1	4100 36	25	6
1	4100 37	32	6
1	4100 38	40	6
1	4100 39	50	6
1	4100 40	63	6
1	4100 41	80	6

*For industrial use only.

DX³ MCBs - 50 kA

thermal magnetic MCBs from 10 A to 63 A



4101 51

4102 17

Violet marking = 50 kA

Technical characteristics p. 39-53

Breaking capacity:
50 kA - IEC 60947-2 - 400 V \sim
Can be equipped with DX³ auxiliaries and accessories

Pack	Cat.Nos	DX ³ MCBs - 50 kA*	
		Single pole 230/400 V\sim	
	D curve	Nominal rating In (A)	Number of modules
1	4101 34	10	1.5
1	4101 35	16	1.5
1	4101 36	20	1.5
1	4101 37	25	1.5
1	4101 38	32	1.5
1	4101 39	40	1.5
1	4101 40	50	1.5
1	4101 41	63	1.5
		2 pole - 230/400 V\sim	
1	4101 47	10	3
1	4101 48	16	3
1	4101 49	20	3
1	4101 50	25	3
1	4101 51	32	3
1	4101 52	40	3
1	4101 53	50	3
1	4101 54	63	3
		3 pole - 400 V\sim	
1	4101 60	10	4.5
1	4101 61	16	4.5
1	4101 62	20	4.5
1	4101 63	25	4.5
1	4101 64	32	4.5
1	4101 65	40	4.5
1	4101 66	50	4.5
1	4101 67	63	4.5
		4 pole - 400 V\sim	
1	4101 73	10	6
1	4101 74	16	6
1	4101 75	20	6
1	4101 76	25	6
1	4101 77	32	6
1	4101 78	40	6
1	4101 79	50	6
1	4101 80	63	6

*For industrial use only.



4088 40

Pack	Cat.Nos	DC MCBs
		Breaking capacity 4.5 kA according to EN 60947-2
		800 V_{DC} circuit breakers
1	4144 24	6 A
1	4144 25	8 A
1	4144 26	10 A
1	4144 27	13 A
1	4144 28	16 A
1	4144 29	20 A
		1000 V_{DC} circuit breakers
1	4144 46	10 A
1	4144 47	13 A
1	4144 48	16 A
1	4144 49	20 A
1	4144 50	25 A
1	4144 51	32 A

Pack	Cat.Nos	RDSO
1	4088 32	0.5 A
1	4088 33	1 A
1	4088 34	1.5 A
1	4088 35	1.6 A
1	4088 36	2.5 A
1	4088 37	3 A
1	4088 38	4 A
1	4088 39	5 A
1	4088 40	10 A
1	4088 42	20 A
1	4088 43	25 A
1	4088 44	30 A
1	4088 45	35 A
1	4088 46	40 A
1	4088 47	50 A
1	4088 48	60 A

Pack	Cat.Nos	Type 2 voltage surge protectors
		DC side protection of photovoltaic installations connected to the low voltage network (without energy storage system) Conforming to UTE guide C 61-740-51 Protection in common mode and residual current mode (Y mode) 1 Consisting of plug-in modules with LED indicator Red: modules need to be replaced
		Voltage surge protectors
1	4141 60	600 V _{DC} 25 KA I _{max}
1	4141 51	1000 V 40 KA I _{max}
		Plug-in replacement module
1	4141 90	+/- cassette for voltage surge protector 4141 60
1	4141 91	T cassette for voltage surge protector 4141 60
1	4141 81	+/- and T cassette for voltage surge protector 4141 51

Pack	Cat.Nos	DC rotary handle isolating switches
		Category of use DC 21B according to EN 60947-3 Double break contacts
		600 V_{DC} isolating switches
1	4142 61	16 A
1	4142 62	25 A
1	4142 63	32 A
		1000 V_{DC} isolating switches
1	4142 81	16 A
1	4142 82	25 A
1	4142 83	32 A
		Accessories
1	4063 05	Pole separation divider
10	4063 07	Spacing unit 0.5 unit

DX³ isolators

ISs for AC applications upto 125 A



DX³ RCCBs

RCCBs for AC applications upto 63 A



4065 00



4065 10



4065 20



4118 51



4118 77



4118 93

Technical characteristics p. 53

- Isolators for AC applications upto 125 A
- ISI marked as per IEC 60947-3
- Integrated label holder
- Ergonomic red color dolly
- Sliding bottom clamp
- Double break mechanism
- Improved air channels
- Color coded On/Off indication on dolly
- Biconnect lower terminals
- IP 20 protected terminals
- Sliding shutters

Technical characteristics p. 54-59

- ISI marked as per IS 12640-1
- Integrated label holder
- Ergonomic Grey color dolly
- Sliding bottom clamp
- Color coded On/Off indication on dolly
- Biconnect lower terminals
- IP 20 protected terminals
- 35 sq mm terminals
- Sliding shutters

Pack	Cat.Nos	Isolators	Nominal rating In (A)	Number of modules
		2 pole 415 V\sim		
1/5/60	4065 00		32	2
1/5/60	4065 01		40	2
1/5/60	4065 02		63	2
1/5/60	4065 04		100	2
1/5/60	4065 05		125	2
		3 pole 415 V\sim		
1/40	4065 09		32	3
1/40	4065 10		40	3
1/40	4065 11		63	3
1/40	4065 13		100	3
1/40	4065 14		125	3
		4 pole 415 V\sim		
1/32	4065 18		32	4
1/32	4065 19		40	4
1/32	4065 20		63	4
1/32	4065 22		100	4
1/32	4065 23		125	4

Pack	Cat.Nos	DX ³ RCCBs	Nominal rating In (A)	Number of modules
		2 pole 240 V\sim		
		30 mA		
1/5/60	4118 51		25	2
1/5/60	4118 52		40	2
1/5/60	4118 53		63	2
		100 mA		
1/5/60	4118 56		25	2
1/5/60	4118 57		40	2
1/5/60	4118 58		63	2
		300 mA		
1/5/60	4118 61		25	2
1/5/60	4118 62		40	2
1/5/60	4118 63		63	2
		4 pole 415 V\sim		
		30 mA		
1/32	4118 76		25	4
1/32	4118 77		40	4
1/32	4118 78		63	4
		100 mA		
1/32	4118 81		25	4
1/32	4118 82		40	4
1/32	4118 83		63	4
		300 mA		
1/32	4118 86		25	4
1/32	4118 87		40	4
1/32	4118 88		63	4
		4 pole 415 V\sim, A-S		
		300 mA		
1/5/60	4118 91		25	4
1/5/60	4118 92		40	4
1/5/60	4118 93		63	4
		2 pole 240 V\sim, HPI		
		30 mA		
1/5/60	4118 71		25	2
1/5/60	4118 72		40	2
1/5/60	4118 73		63	2
		4 pole 415 V\sim, HPI		
		30 mA		
1/32	4118 96		25	4
1/32	4118 97		40	4
1/32	4118 98		63	4

DX³ RCCBs

RCCBs for AC applications 80 - 100 A

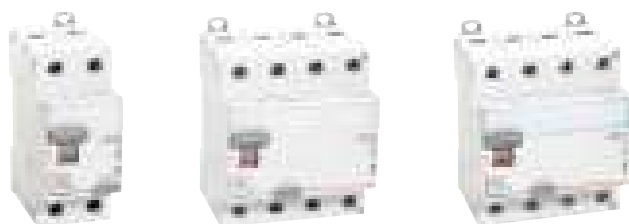

4115 08

4117 05

4117 15

Technical characteristics p. 54-59

Integrated label holder
Ergonomic Grey color dolly
Color coded On/Off indication on dolly
IP 20 protected terminals
35 sq mm terminals
Sliding shutters
B type detect sinusoidal AC, pulsating DC and smooth DC residual currents

Pack	Cat.Nos	DX ³ RCCBs*	Number of modules
		2 pole 240 V~	
		30 mA	
		Nominal rating In (A)	
1/5/60	4115 07	80	2
		100 mA	
1/5/60	4115 17	80	2
		300 mA	
1/5/60	4115 27	80	2
		4 pole 415 V~	
		30 mA	
1/32	4117 05	80	4
1/32	4117 63	100	4
		100 mA	
1/32	4117 15	80	4
1/32	4117 73	100	4
		300 mA	
1/32	4117 25	80	4
1/32	4117 83	100	4
		2 pole 240 V~, HPI	
		30 mA	
1/5/60	4118 74	80	2
		4 pole 415 V~, HPI	
		30 mA	
1/32	4118 99	80	4
		4 pole 415 V~, A-S	
		300 mA	
1/5/60	4118 94	80	4
		2 pole 230 V~, B type	
		Do not accept auxiliaries	
		30 mA	
1	4118 42	40	2
1	4118 43	63	2
		300 mA	
1	4118 44	40	2
1	4118 45	63	2
		4 pole 400 V~, neutral on left-hand side	
		B type	
		Do not accept auxiliaries	
		30 mA	
1	4118 46	40	4
1	4118 47	63	4
		300 mA	
1	4118 48	40	4
1	4118 49	63	4

*For industrial use only.

DX³ RCBOs

RCBOs assembled for AC applications upto 63 A

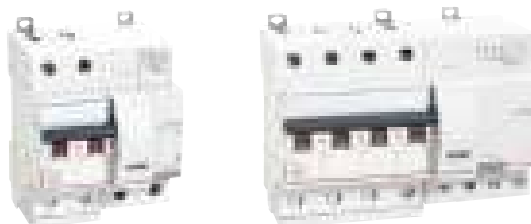

4113 24

4113 79

Technical characteristics p. 54-59

ISI marked as per IS 12640-2
Integrated label holder
Ergonomic design
Color coded On/Off indication on dolly
Front face indication for earth leakage fault
IP 20 protected terminals
35 sq mm terminals
Sliding shutters

Pack	Cat.Nos	DX ³ RCBOs	Number of modules
		2 pole 240 V~, AC Type	
		30 mA	
		Nominal rating In (A)	
1/32	4113 22	6	4
1/32	4113 23	10	4
1/32	4113 24	16	4
1/32	4113 25	25	4
1/32	4113 26	32	4
1/32	4113 27	40	4
1/32	4113 28	63	4
		100 mA	
1/32	4113 29	6	4
1/32	4113 30	10	4
1/32	4113 31	16	4
1/32	4113 32	25	4
1/32	4113 33	32	4
1/32	4113 34	40	4
1/32	4113 35	63	4
		300 mA	
1/32	4113 36	16	4
1/32	4113 37	25	4
1/32	4113 38	32	4
1/32	4113 39	40	4
1/32	4113 40	63	4
		4 pole 415 V~, AC Type	
		30 mA	
1/16	4113 88	6	7
1/16	4113 89	10	7
1/16	4113 65	16	7
1/16	4113 66	25	7
1/16	4113 67	32	7
1/16	4113 68	40	7
1/16	4113 69	63	7
		100 mA	
1/16	4113 70	16	7
1/16	4113 71	25	7
1/16	4113 72	32	7
1/16	4113 73	40	7
1/16	4113 74	63	7
		300 mA	
1/16	4113 75	16	7
1/16	4113 76	25	7
1/16	4113 77	32	7
1/16	4113 78	40	7
1/16	4113 79	63	7

DX³ RCBOs

RCBOs compact for AC applications upto 32 A, 6 kA



4113 94

4111 88

4112 08

Technical characteristics p. 54-59

Pack	Cat.Nos	DX ³ RCBOs, 2 pole 240 V \sim	
		ISI marked as per IEC 61009 Integrated label holder Ergonomic design Color coded On/Off indication on dolly Front face indication for earth leakage fault IP 20 protected terminals 35 sq mm terminals Sliding shutters	
		AC Type	
		30 mA	
		Nominal rating I _n (A)	Number of modules
1/32	4113 90	6	2
1/32	4113 91	10	2
1/32	4113 92	16	2
1/32	4113 93	20	2
1/32	4113 94	25	2
1/32	4113 95	32	2
		300 mA	
1/32	4113 97	6	2
1/32	4113 98	10	2
1/32	4113 99	16	2
1/32	4114 00	20	2
1/32	4114 01	25	2
1/32	4114 02	32	2
		HPI Type	
		30 mA	
1/32	4114 15	25	2
1/32	4114 16	32	2

Pack	Cat.Nos	DX ³ RCBOs, 4 pole 415 V \sim	
		Complies to per IEC 61009 Integrated label holder Ergonomic design Color coded On/Off indication on dolly Front face indication for earth leakage fault IP 20 protected terminals 35 sq mm terminals Sliding shutters	
		AC Type	
		30 mA	
		Nominal rating I _n (A)	Number of modules
1/16	4111 85	10	4
1/16	4111 86	16	4
1/16	4111 87	20	4
1/16	4111 88	25	4
1/16	4111 89	32	4
		300 mA	
1/16	4112 04	10	4
1/16	4112 05	16	4
1/16	4112 06	20	4
1/16	4112 07	25	4
1/16	4112 08	32	4
		A Type	
		30 mA	
1/16	4112 33	10	4
1/16	4112 34	16	4
1/16	4112 35	20	4
1/16	4112 36	25	4
1/16	4112 37	32	4
		300 mA	
1/16	4112 38	10	4
1/16	4112 39	16	4
1/16	4112 40	20	4
1/16	4112 41	25	4
1/16	4112 42	32	4

DX³ RCD add on module

For 125 A

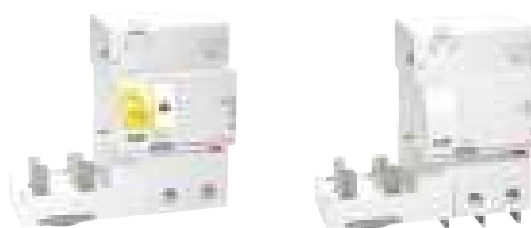

4105 68

4105 78

Technical characteristics p. 54-59

Conform to IEC 60947-2
 AC type : detect AC components faults
 Hpi type : detect faults with AC and DC components, increased
 Immunity to false tripping
 For mounting on the right-hand side of 1.5 module per pole DX³ MCBs
 Easy & fast association mechanism
 Terminal cover for locking
 70 sq mm terminals

Pack	Cat.Nos	DX ³ RCD	
		2 pole 240 V\sim, AC Type	
		30 mA	
		Nominal rating I _n (A)	Number of modules
1	4105 68	125 A	4
1	4105 69	125 A	4
1	4105 71	125 A	4
		4 pole 415 V\sim, AC Type	
		30 mA	
1	4106 25	125 A	4
1	4106 26	125 A	4
1	4106 29	125 A	4
		2 pole 240 V\sim, HPI type	
		30 mA	
1	4105 78	125 A	6
1	4105 79	125 A	6
1	4105 82	125 A	6
		Four pole 415 V\sim, HPI type	
		30 mA	
1	4106 38	125 A	6
1	4106 39	125 A	6
1	4106 42	125 A	6

DX³ auxiliaries

Auxiliaries common for MCBs, Isolators, RCCBs & RCBOs

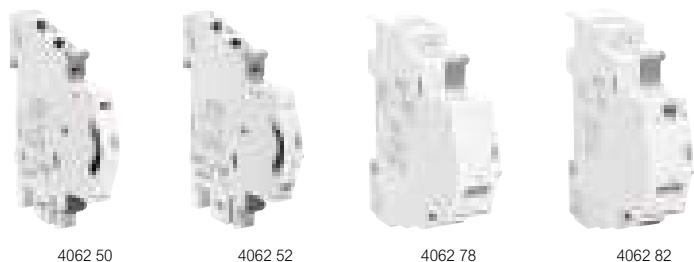

Technical characteristics **p. 61**

Easy & fast fixation on site
On site clip on mounting
Clip on fitting on left side

Pack	Cat.Nos	Signalling auxiliaries	Number of modules
1	4062 50	Auxiliary changeover switch 6 A	0.5
1	4062 52	Fault signalling changeover switch 6 A	0.5
1	4062 64	Changeover + fault signalling switch	1
Control auxiliaries			
1	4062 76	Shunt release 12 /48 V AC/DC	1
1	4062 78	Shunt release 110/415 V AC	1
1	4062 80	Undervoltage release 24/48 V AC/DC	1
1	4062 82	Undervoltage release 230 V AC	1
1	4062 86	Pop over voltage release	1
1	4062 90	Motor control 24/48 V AC/DC	1
1	4062 91	Motor control 230 V AC	1
1	4062 93	Motor control auto reset 24/48 V AC/DC	2
1	4062 95	Motor control auto reset 230 V AC	2
1	4062 88	Automatic resetter	2
1	4062 89	Automatic resetter with autotest	2
Rotary handle			
10	4063 19	Black rotary handle	-
10	4063 20	Yellow/red rotary handle	-
Support for padlock			
10	4063 03	Support for padlock till 63 A	-
Sealable screw cover			
10	4063 04	Devices upto 63 A	-
10	4063 06	For 80-125 A devices	-
1/2 module spacing unit			
10	4063 07	1/2 module spacing unit	0.5
5 mm padlock			
10	4063 13	1/2 module spacing unit	-

DX³ auxiliaries

Manual changover switch



Compact design
Manual switching operation
Easy to assemble
Ergonomic design

Pack	Cat.Nos	For 1 mod/pole MCBs and ISs	Number of modules
5	4063 14	Manual change-over switch for DP	2
5	4063 15	Manual change-over switch for TP	3
5	4063 16	Manual change-over switch for FP	3

DX³ RCD add on module with measurement & metering



4106 57

Technical characteristics **p. 59**

Conform to IEC 60947-2
 Hpi type: detect faults with AC and DC components, increased
 Immunity to false tripping
 Inbuilt measurement/metering option
 Measurement - V, A, F, PF, kWh, kVA, kVAr, THD
 Metering - V, A, F, kWh
 RS 485 port for remote reading
 Di-electric test button inbuilt
 Ergonomic test button
 Scroll button for easy readings
 RLCD display on front fascia
 For mounting on the right-hand side of 1.5 module per pole DX³ MCBs
 Easy & fast association mechanism
 70 sq mm terminals

Pack	Cat.Nos	Adjustable metering, 4 pole 415 V _~	
		Nominal rating I _n (A)	Number of modules
1	4106 57	63 A	7
1	4106 58	125 A	7
Adjustable measurement			
1	4106 59	125 A	7

DX³ time switches



4126 41

4126 54

4126 57

4126 29

Technical characteristics **p. 62-66**

Daily and weekly time switch
 Quick and easy programming due to the option to select day blocks, day blocks can be individually set or selected from the blocks Mon–Sun, Mon–Fri or Sat–Sun
 Programming with precision to the second
 Switch times visible in weekly overview on display

Pack	Cat.Nos	Alpharex ³ digital time switches
1	4126 31	AlphaRex ³ D21, 1 channel
1	4126 41	AlphaRex ³ D22, 2 channels
1	4126 34	AlphaRex ³ D21s, 1 channel, with control input

Pack	Cat.Nos	Alpharex ³ digital time switches - Astro
<ul style="list-style-type: none"> For switching on/off lights and other electric devices according to the rising/setting of the sun With combination function for creating switching programs in which the devices are switched according to astronomical time and/or fixed preset times Daily astronomical calculation of the sunrise/sunset times based on the entered location or location coordinates 		
1	4126 54	AlphaRex ³ D21 astro, 1 channel
1	4126 57	AlphaRex ³ D22 astro, 2 channels

Pack	Cat.Nos	Alpharex ³ yearly time switch
<ul style="list-style-type: none"> Yearly and weekly time switch with additional astronomical function for all channels 84 switching programs per channel, comprising: <ul style="list-style-type: none"> 28 weekly programs 28 yearly programs 28 special programs (priority program) 		
1	4126 29	AlphaRex ³ DY21, 1 channel
1	4126 30	AlphaRex ³ DY22, 2 channels

Pack	Cat.Nos	Programming accessories
1	4128 72	Data key
1	4128 73	PC adapter for USB port

DX³ time switches



4128 12

4128 14

Technical characteristics **p. 62-66**

With synchronous (mains-synchronised clock precision) or quartz motor

- +/-2.5 s/day clock precision (quartz motor)
- Surface-mounting possible with a wall bracket and a terminal cover (Cat.No 4128 59)
- Unit width: 3 modules of 17.5 mm each

Pack	Cat.Nos	Twilight switches
1	4126 23	<ul style="list-style-type: none"> • Including light sensor • Wire for light sensor: 2 x 1.5 mm², maximum wire length: 50 m • LED switching status indicator Luxo switch

Pack	Cat.Nos	MicroRex analog time switches
1	4128 12	In accordance with IEC 60730-1 and 60730-2-7 Manual switching ON/automatic/OFF daily/weekly switching dial with captive segments Clock precision: +/- 5 min for the daily time switch -10 °C to +55 °C operating temperature
1	4128 13	
1	4128 14	
1	4127 90	
1	4127 94	

Pack	Cat.Nos	Accessory
1	4128 59	Wall bracket

DX³ contactors



4125 44

Technical characteristics **p. 67**

Conform to IEC/EN 61095

Space for power supply busbar on top (up to 63 A)

Pack	Cat.Nos	Power contactors CX³
1	4125 44	25 A 2 NO contactor
1	4125 45	40 A 2 NO contactor
1	4125 47	63 A 2 NO contactor
1	4125 48	63 A 2 NC contactor
1	4125 49	40 A 3 NO contactor
1	4125 50	63 A 3 NO contactor
1	4125 51	25 A 4 NO contactor
1	4125 53	40 A 4 NO contactor
1	4125 56	63 A 4 NO contactor
1	4125 57	63 A 4 NC contactor

Pack	Cat.Nos	Signalling auxiliaries for contactors
1	4124 29	Auxiliary changeover switch For 1 module contactors 16 A to 25 A
1	4124 30	For 2 module contactors 25 A
1	4124 31	For 40 and 63 A contactors

CX³ changeover switches, push-buttons, control switches and LED indicators

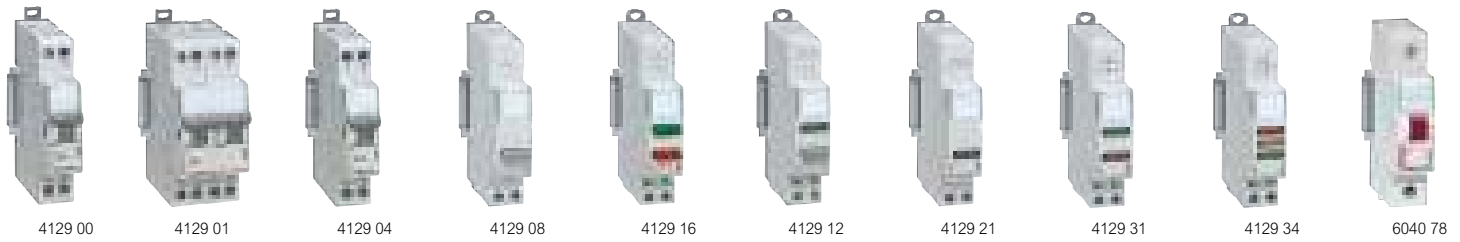

Technical characteristics p. 67

Pack	Cat.Nos	Changeover switches	Number of modules
		Conform to IEC 60669-1 Nominal rating 32 A Compatible with fluorescent lamps (20 AX)	
10	4129 00	Two-way - 250 V~ Connection	1
5	4129 01	Double two-way - 400 V~ 	2
10	4129 02	Two way with centre point - 250 V~ 	1
5	4129 03	Double two way with centre point - 250 V~ 	2
10	4129 04	Switch NO + NC - 250 V~ 	1

Pack	Cat.Nos	Push-buttons and control switches	Number of modules
		Conform to IEC 60669-1 Nominal rating 20 A - 250 V~ Compatible with florescent lamps (20 AX) Accept prong-type supply busbars	
		Single function push-buttons	
10	4129 08	1 NO Connection	1
10	4129 09	1 NC Connection	1
10	4129 16	Dual functions push-buttons without indicator 1 NO (green push-button) + 1 NC (red push-button) Connection	1
10	4129 10	Single function control switches 2 NO Connection	1
10	4129 11	1 NO + NC Connection	1

Pack	Cat.Nos	Push-buttons and control switches (continued)	Number of modules
		Dual functions control switches with indicator	
10	4129 12	1 NO + green LED indicator 12/48 V~/=	1
10	4129 13	1 NC + red LED indicator 12/48 V~/=	1
10	4129 14	1 NO + green LED indicator 110/400 V~	1
10	4129 15	1 NC + red LED indicator 110/400 V~	1

Pack	Cat.Nos	LED indicators	Number of modules
		Equipped with non replaceable LED lamps LED life: 100 000 h LED consumption: 0.17 W under 230 V~/ 0.11 W under 24 V~ Conform to IEC 60947-5-1 Accept prong-type supply busbars	
		Single - 12/48 V~/=	
10	4129 21	● Green	1
10	4129 22	● Red	1
10	4129 23	● Yellow	1
10	4129 24	● Blue	1
10	4129 25	○ White	1
10	4129 26	● Green	1
10	4129 27	● Red	1
10	4129 28	● Yellow	1
10	4129 29	● Blue	1
10	4129 30	○ White	1
10	4129 31	Double - 110/400 V~ ●● Green/Red	1
10	4129 32	Triple - 230/400 V~ ○○○ White	1
10	4129 33	●●● Red	1
10	4129 34	●●● Red/Yellow/Green	1
10	4129 35	●●● Red/Yellow/Blue	1

Pack	Cat.Nos	TX ³ LED indicators - 250 V~	Number of modules
		Equipped with non replaceable LED lamps	
		Single	
12	6040 77	● Green	1
12	6040 78	● Red	1
12	6040 79	● Orange	1

EMDX³ electrical energy meters

┌ rail mounting



EMDX³ multi-function measuring units

┌ rail mounting



0046 74

Technical characteristics p. 68-69

Measure the electricity consumed by a single-phase or three-phase circuit downstream of the electricity distribution metering. Display electricity consumption in kWh, as well as other values such as current, active energy, reactive energy and power (depending on the catalogue number).

Conform to standards IEC 62053-21/23, IEC 62052-11 and IEC 61010-1. MID compliance ensures accuracy of the metering with a view to recharging for the electricity used.

Pack	Cat.Nos	Single-phase meters
1	0046 77	Direct connection 63 A - 2 modules RS 485 output
1	0046 80	Direct connection 63 A - 4 modules RS 485 output
1	0046 84	Connection with CT 5 A - 4 modules RS 485 and pulse output



0046 76

Technical characteristics p. 68-69

Conform to standards:

- IEC 61557-12
- IEC 62053-22 class 0.5 S
- IEC 62053-23 class 2

Pack	Cat.Nos	EMDX ³ modular
		For mounting on ┌ rail Width: 4 modules • LCD display • Measurement of currents, voltages, active, reactive and apparent power and internal temperature • Dual tariff metering: - Active energy consumed - Reactive energy consumed - Operating time - Power factor • THD voltages and currents up to order 51 • Programmable alarms on all functions • Outputs for controlling wiring devices, alarm feedback and pulse feedback
1	0046 76	EMDX³ RS 485 unit Data transmission via RS 485 communication interface and pulses

EMDX³

communication and supervision



0261 78

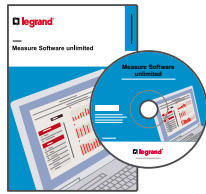

0261 88/89

Technical characteristics p. 68-69

Pack	Cat.Nos	Communication and supervision
1	0261 78	Web servers For 32 metering points (meters or multi-function measuring units)
1	0261 79	Web servers For an unlimited number of metering points (meters or multi-function measuring units)
1	0261 88	Legrand Software For 32 metering points (supplied on CD)
1	0261 89	Legrand Software For an unlimited number of metering points (supplied on CD)
1	0046 89	RS485/IP Convertor 230 V AC

EMDX³

measurement and control of electric equipment



0261 37

Technical characteristics p. 68-69

Pack	Cat.Nos	Measurement and control of electric equipment
1/2	0261 35	Central position
1/3	0261 37	Microprocessor interface
1/2	0261 36	Interface signaling and control
1/4	0261 45	Kit configurator
1/20	0466 23	Stabilized power

Class I (T1) low voltage SPDs



4122 75

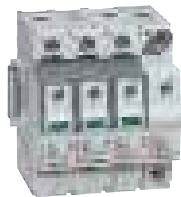

4122 57



4122 83



4123 03



4122 84

Technical characteristics **p. 70-72**

Protection against transient overvoltages for 230/400 V~ power networks (50/60 Hz). SPDs compliant with EN/IEC 61643-11 standards
Recommended for main distribution boards
Class I+II (T1+T2) : SPDs tested and specified according to both T1 and T2 test classes

Pack	Cat.Nos	SPDs for general protection of main distribution board				
		SPDs with plug-in modules and status indicators: - Green: SPD operational - Orange: plug-in modules to be replaced Earthing systems: TT, TNC, TNS				
		T1+T2 - limp 12,5 kA/pole For general protection of big installations and protection of small installations with external lightning protection (LPS). Up: 1.5 kV - I _{max} : 60 kA/pole - U _c : 320 V~ Recommended MCB: DX ³ 63 A - C curve				
		Number of poles	Neutral position	I _{total} (10/350)	Remote status monitoring (FS contact)	Number of modules
1	4122 70	1P	-	12.5 kA	No	1
1	4122 76¹	1P+N	Right	25 kA	Yes	2
1	4122 71	2P	-	25 kA	No	2
1	4122 72	3P	-	37.5 kA	Yes	3
1	4122 77¹	3P+N	Right	50 kA	Yes	4
1	4122 73	4P	-	50 kA	No	4
		T1+T2 - limp 8 kA/pole SPDs for small installations without external lightning protection (LPS) Up: 1.3 kV - I _{max} : 50 kA/pole - U _c : 320 V~ Recommended MCB: DX ³ 40 A - C curve				
1	4122 50	1P	-	8 kA	No	1
1	4122 56¹	1P+N	Right	16 kA	No	2
1	4122 51	2P	-	16 kA	No	2
1	4122 52	3P	-	25 kA	No	3
1	4122 57¹	3P+N	Right	25 kA	No	4
1	4122 53	4P	-	32 kA	No	4

Pack	Cat.Nos	SPDs for high risk level installations				
		SPDs for big installations with external lightning protection (LPS) and for high risk level installations according to EN/IEC 62305 standards.				
		T1 - limp 50 kA/pole - 440V~ (IT) - Monobloc Up: 2.5 kV - U _c : 440 V~ Earthing systems: TT, TNC, TNS, IT Recommended MCB: DPX ³ 160 - 80 A				
		Number of poles	I _{total} (10/350)	Remote status monitoring (FS contact)	Number of modules	
1	0030 00²	1P	50 kA	No	2	

Pack	Cat.Nos	SPDs for high risk level installations (continued)				
		T1 - limp 35 kA/pole - 440V~ (IT) - Plug-in SPDs with plug-in modules and status indicators: - Green: SPD operational - Red: plug-in modules to be replaced Up: 2.5 kV - U _c : 440 V~ Earthing systems: TT, TNC, TNS, IT Recommended MCB: DPX ³ 160 - 80 A				
		Number of poles	Neutral position	I _{total} (10/350)	Remote status monitoring (FS contact)	Number of modules
1	4122 80	1P	-	35 kA	Yes	2
		T1 - limp 25 kA/pole SPDs with plug-in modules and status indicators: - Green: SPD operational - Red: plug-in modules to be replaced Up: 1.5 kV - U _c : 350 V~ Earthing systems: TT, TNC, TNS. Recommended MCB: DPX ³ 160 - 80 A				
1	4122 81¹	1P+N	Right	50 kA	Yes	4
1	4122 82	3P	-	75 kA	Yes	6
1	4122 83¹	3P+N	Right	100 kA	Yes	8
		Replacement plug-in modules				
1	4123 02	For SPDs T1+T2 - 8 kA Cat.Nos 4122 50/51/52/53/56/57				
1	4123 03	For SPDs T1+T2 - 12.5 kA Cat.Nos 4122 70/71/72/73/76/77				
1	4122 84	For SPDs T1 - 25 kA Cat.Nos 4122 81/82/83 and 0030 20/22/23/27				
1	4122 85	N-PE module for SPDs T1 - 25 kA Cat.Nos 4122 81/83 and 0030 23				
1	4122 86	For SPDs T1 - 35 kA Cat.No 4122 80				
		Cablings accessories				
1	4123 10	Ready to use cabling kit consisting of 5 conductors (including the earth conductor) Cross section :16 mm ² Length : 40 cm For cabling SPDs in industrial enclosures (for EN/IEC 61439 compliance).				

1: 1P+N and 3P+N: L-N and N-PE protection modes (common and differential modes), the N pole being protected by encapsulated spark gaps. Also called sometimes 1+1 and 3+1
2: Replaced mid 2015 by Cat.No 4122 80

Class II (T2) low voltage SPDs

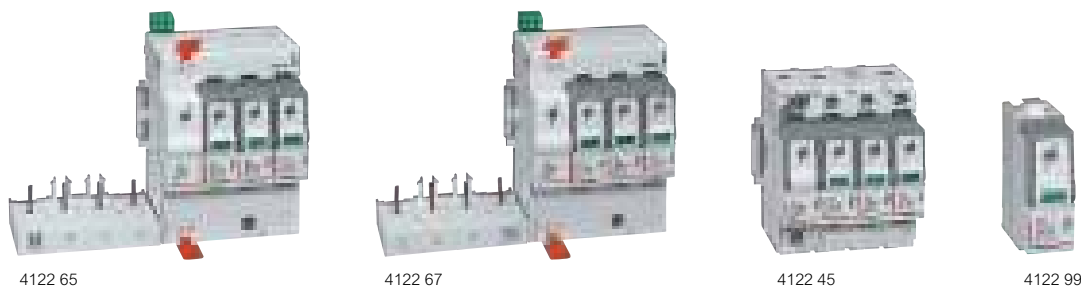

Technical characteristics p. 70-72

Protection against transient overvoltages for 230/400 V \sim power networks (50/60 Hz). SPDs compliant with EN/IEC 61643-11 standards Recommended for distribution boards

Pack Cat.Nos T2 add-on SPDs

SPDs with plug-in modules and status indicators:
 - Green: SPD operational
 - Orange: plug-in modules to be replaced
 SPDs providing increased safety during their lifetime and maintenance cycles. Prewired MCB connexions for increased reliability and for quick and easy Installation.
 To be equipped with DX³ MCBs (1 module/pole)
 Earthing systems: TT, TNS

T2 - I_{max} 40 kA/pole

SPDs recommended for power installations
 Up: 1.7 kV - In: 20 kA/pole - Uc: 320 V \sim
 Recommended MCB: DX³ 25 A - C curve

Pack	Cat.Nos	Number of poles	Neutral position	Remote status monitoring (FS contact)	Number of modules
1	4122 66¹	1P+N	Right	Yes	4
1	4122 67¹	3P+N	Right	Yes	8

T2 - I_{max} 20 kA/pole

SPDs recommended for small installations
 Up: 1.2 kV - In: 5 kA/pole - Uc: 320 V \sim
 Recommended MCB: DX³ 20A - C curve

1	4122 62¹	1P+N	Right	Yes	4
1	4122 63¹	3P+N	Right	Yes	8

Pack Cat.Nos T2 SPDs

SPDs with plug-in modules and status indicators:
 - Green: SPD operational
 - Orange: plug-in modules to be replaced

T2 - I_{max} 40 kA/pole

SPDs recommended for power installations
 Up: 1.7 kV - In: 20 kA/pole - Uc: 320 V \sim
 Earthing systems : TT, TNC, TNS
 Recommended MCB: DX³ 25 A - C curve

Pack	Cat.Nos	Number of poles	Neutral position	Remote status monitoring (FS contact)	Number of modules
1	4122 40	1P	-	No	1
1	4122 46¹	1P+N	Right	No	2
1	4122 41	2P	-	No	2
1	4122 42	3P	-	Yes	3
1	4122 47¹	3P+N	Right	No	4
1	4122 43	4P	-	No	4

T2 - I_{max} 40 kA/pole - 440 V \sim (IT)

SPDs recommended for big installations
 Up: 2.1 kV - In: 20 kA/pole - Uc: 440 V \sim
 Earthing systems : TT, TNC, TNS, IT
 Recommended MCB: DX³ 25 A - C curve

1	4122 30	1P	-	No	1
1	4122 32	3P	-	Yes	3
1	4122 33	4P	-	Yes	4

T2 - I_{max} 20 kA/pole

SPDs recommended for small installations
 Up: 1.2 kV - In: 5 kA/pole - Uc: 320 V \sim
 Earthing systems : TT, TNC, TNS
 Recommended MCB: DX³ 20 A - C curve

1	4122 20	1P	-	No	1
1	4122 26¹	1P+N	Right	No	2
1	4122 21	2P	-	No	2
1	4122 27¹	3P+N	Right	No	4
1	4122 23	4P	-	No	4

Replacement plug-in modules

1	4122 99	For SPDs T2 - 40 kA Cat.Nos 4122 40/41/42/43/44/45/46/47/66/67
1	4123 00	N-PE module for SPDs T2 - 40 kA Cat.Nos 4122 46/47
1	4123 01	For SPDs T2 - 440 V Cat.Nos 4122 30/32/33
1	4122 97	For SPDs T2 - 20 kA Cat.Nos 4122 20/21/23/26/27/62/63
1	4123 98	N-PE module for SPDs T2 - 20 kA Cat.Nos 4122 24/25/26/27

1: 1P+N and 3P+N: L-N and N-PE protection modes (common and differential modes), the N pole being protected by encapsulated spark gaps. Also called sometimes 1+1 and 3+1

Class II (T2) low voltage SPDs with integrated protection

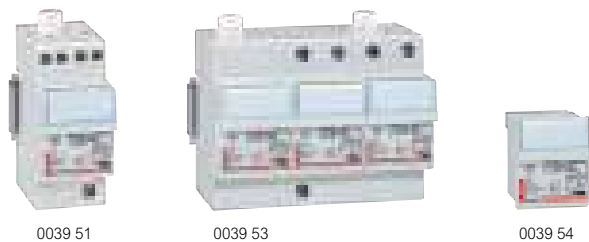

Technical characteristics p. 70-72

SPDs with integrated protection against overload currents and short-circuit currents
 SPDs compliant with EN/IEC 61643-11 standards
 For 230/400 V~ power networks (50/60 Hz)

Pack	Cat.Nos	Protection for consumer units												
1	0039 51¹	For residential and small commercial installations With plug-in modules and status indicators: - Green: SPD operational - Red: plug-in module need to be replaced T2 self protected SPDs - I_{max} 12 kA/pole For installations with low risk level (in urban areas, underground power supplies, etc.) In: 10 kA/pole - U _c : 275 V~ Earthing systems: TT, TNS Cat.No 0039 51: SPDs with Y connection (both incoming and outgoing terminals at the top of the SPDs) providing better protection against overvoltages												
1	0039 53¹													
		<table border="1"> <thead> <tr> <th>Number of poles</th> <th>Neutral position</th> <th>Integrated protection</th> <th>Number of modules</th> </tr> </thead> <tbody> <tr> <td>1P+N</td> <td>Left</td> <td>I_{sc} ≤ 6 kA</td> <td>2</td> </tr> <tr> <td>3P+N</td> <td>Left</td> <td>I_{sc} ≤ 6 kA</td> <td>6</td> </tr> </tbody> </table>	Number of poles	Neutral position	Integrated protection	Number of modules	1P+N	Left	I _{sc} ≤ 6 kA	2	3P+N	Left	I _{sc} ≤ 6 kA	6
Number of poles	Neutral position	Integrated protection	Number of modules											
1P+N	Left	I _{sc} ≤ 6 kA	2											
3P+N	Left	I _{sc} ≤ 6 kA	6											

Pack	Cat.Nos	Protection for secondary distribution boards												
1	0039 71¹	Protection of sensitive equipment. With plug-in modules and status indicators: - Green: SPD operational - Red: plug-in module need to be replaced In: 10 kA/pole - U _c : 275 V~ Earthing systems: TT, TNS. Cat.No 0039 71: both incoming and outgoing terminals at the top of the SPDs, providing better protection against overvoltages T2 self protected SPDs - I_{max} 12 kA/pole												
1	0039 73¹													
		<table border="1"> <thead> <tr> <th>Number of poles</th> <th>Neutral position</th> <th>Integrated protection</th> <th>Number of modules</th> </tr> </thead> <tbody> <tr> <td>1P+N</td> <td>Left</td> <td>I_{sc} ≤ 10 kA</td> <td>2</td> </tr> <tr> <td>3P+N</td> <td>Left</td> <td>I_{sc} ≤ 10 kA</td> <td>6</td> </tr> </tbody> </table>	Number of poles	Neutral position	Integrated protection	Number of modules	1P+N	Left	I _{sc} ≤ 10 kA	2	3P+N	Left	I _{sc} ≤ 10 kA	6
Number of poles	Neutral position	Integrated protection	Number of modules											
1P+N	Left	I _{sc} ≤ 10 kA	2											
3P+N	Left	I _{sc} ≤ 10 kA	6											

Pack	Cat.Nos	Replacement plug-in modules
1	0039 54	For self protected SPDs
1	0039 74	
		For old SPDs
1	0039 28	Cat.Nos 0039 20/21/22/23
1	0039 34	Cat.Nos 0039 30/31/32/33
1	0039 39	Cat.Nos 0039 35/36/38
1	0039 44	Cat.Nos 0039 40/41/43

SPDs for telephone lines



Technical characteristics p. 70-72

Pack	Cat.Nos	SPDs for telephone and data lines								
		Overvoltage protection of equipment such as telephones, modems, video door entry phones, RS485 networks, measurement loops, etc. Not compatible with VDSLs SPDs needed to provide complete protection of the installation when low voltage SPDs are present (TS/IEC 61643-12). SPDs with status indicators: - Green: SPD operational - Orange: plug-in module need to be replaced Compliant with EN/IEC 61643-21 standards "Analogue" SPD (STN, non- unbundled ADSL, etc.)								
1	0038 28	<table border="1"> <thead> <tr> <th>In/I_{max}</th> <th>Max. voltage(U_c)</th> <th>Level of protection (Up)</th> <th>Number of modules</th> </tr> </thead> <tbody> <tr> <td>5/10 kA</td> <td>170 V</td> <td>260 V</td> <td>1</td> </tr> </tbody> </table>	In/I _{max}	Max. voltage(U _c)	Level of protection (Up)	Number of modules	5/10 kA	170 V	260 V	1
In/I _{max}	Max. voltage(U _c)	Level of protection (Up)	Number of modules							
5/10 kA	170 V	260 V	1							
1	0038 29	"Digital" SPD (unbundled ADSL, SDSL, ISDN, etc.) <table border="1"> <thead> <tr> <th>In/I_{max}</th> <th>Max. voltage(U_c)</th> <th>Level of protection (Up)</th> <th>Number of modules</th> </tr> </thead> <tbody> <tr> <td>5/10 kA</td> <td>48 V</td> <td>100 V</td> <td>1</td> </tr> </tbody> </table>	In/I _{max}	Max. voltage(U _c)	Level of protection (Up)	Number of modules	5/10 kA	48 V	100 V	1
In/I _{max}	Max. voltage(U _c)	Level of protection (Up)	Number of modules							
5/10 kA	48 V	100 V	1							

1: 1P+N and 3P+N: L-N and N-PE protection modes (common and differential modes), the N pole being protected by encapsulated spark gaps. Also called sometimes 1+1 and 3+1

Technical data

Specifications	IS/IEC 60898-1 2002	
Number of poles	SP, SPN, DP, TP, TPN, FP	
Characteristics	C & D Curve	
Breaking capacity	10 kA 0.5 A to 63 A as per IS/IEC 60898-1 2002 16 kA for 0.5 A to 25 A as per IEC 60947-2	
Rated voltage	230 V/400 V	
Current limitation class	Class 3	
Frequency	50 Hz/60 Hz	
Minimum operating voltage	12 V AC/DC	
Enclosures	Polyester self extinguishing, heat and fire resistant according to IEC 60898-1, glow-wire test at 960 °C for external parts made of insulating material necessary to retain in position current-carrying parts and parts of protective circuit (650 °C for all other external parts made of insulating material)	
Mounting position	Vertical / Horizontal / Upside down / On the side	
Fixing	On symmetric rail EN/IEC 60715 or DIN 35	
Maximum cable size	Top/Bottom	1 x 1.5 mm ² to 35 mm ²
	Rigid cable	2 x 1.5 mm ² to 16 mm ²
	Top/Bottom	1 x 1.5 mm ² to 25 mm ²
	Flexible cable	2 x 1.5 mm ² to 10 mm ²
Applied connection torque	Recommended : 2.5 Nm Minimum : 2 Nm Maximum: 3 Nm	
Mechanical endurance	20000 operations without load	
Electrical endurance	10000 operations with load (under $\ln^* \cos \phi = 0.9$) 2000 operations under \ln , DC current	
Permissible ambient temperature	0.5 to 63A - Maximum + 70 °C Minimum -25 °C	

Specifications	IEC 60947-2	
Number of poles	SP, DP, TP, FP	
Breaking capacity	10 kA 80 A to 125 A as per IEC 60898 16 kA for 80 A to 125 A as per IEC 60947-2	
Rated voltage	230 V/400 V	
Current limitation class	Class 3	
Frequency	50 Hz/60 Hz	
Minimum operating voltage	12 V AC/DC	
Enclosures	Polyester self extinguishing, heat and fire resistant according to IEC 60898-1, glow-wire test at 960 °C for external parts made of insulating material necessary to retain in position current-carrying parts and parts of protective circuit (650 °C for all other external parts made of insulating material)	
Mounting position	Vertical / Horizontal / Upside down / On the side	
Fixing	On symmetric rail EN/IEC 60715 or DIN 35	
Maximum cable size	Top/Bottom	1 x 1.5 mm ² to 50 mm ²
	Rigid cable	2 x 1.5 mm ² to 25 mm ²
	Top/Bottom	1 x 1.5 mm ² to 35 mm ²
	Flexible cable	2 x 1.5 mm ² to 20 mm ²
Applied connection torque	Recommended : 2.5 Nm Minimum : 2 Nm Maximum: 3 Nm	
Mechanical endurance	20000 operations without load	
Electrical endurance	10000 operations with load (under $\ln^* \cos \phi = 0.9$) 2000 operations under \ln , DC current	
Permissible ambient temperature	80 to 125 A - Maximum + 70 °C Minimum -25 °C	

Power dissipated in Watt per pole at In

Circuit breakers C and D curves

In (A)	0,5	1	1,6	2	3	4	5	6	7,5	10	16	20	25	32	40	50	63
1P ÷ 4P	1.7	2	2	2	2	2	2.1	1.1	1.4	1.8	2	2.2	2.7	3.2	4	4.5	5.5

Permitted limit as per IEC 60898	3	3	3	3	3	3	3	3	3	3.5	4.5	4.5	6	7.5	9	13
----------------------------------	---	---	---	---	---	---	---	---	---	-----	-----	-----	---	-----	---	----

 Impedance per pole (Ω) = $\frac{P \text{ dissipated}}{\ln^2}$

In (A)	Ambient Temperature / In									
	-25 °C	-10 °C	0 °C	10 °C	20 °C	30 °C	40 °C	50 °C	60 °C	70 °C
0.5	0.62	0.6	0.57	0.55	0.52	0.5	0.47	0.42	0.40	0.38
1	1.5	1.4	1.3	1.2	1.1	1	0.9	0.8	0.7	0.6
2	2.8	2.6	2.5	2.3	2.2	2	1.9	1.8	1.7	
3	3.8	3.6	3.5	3.3	3.2	3.0	2.9	2.8	2.7	2.6
4	4.5	4.2	4.0	3.9	3.7	3.5	3.4	3.3	3.2	3.1
5	6.4	6.0	5.8	5.5	5.3	5.0	4.8	4.7	4.5	4.6
6	7.5	7.0	6.6	6.4	6.2	6.0	5.8	5.6	5.4	5.3
10	12.5	11.5	11.1	10.7	10.3	10.0	9.7	9.3	9.0	8.7
16	20.0	18.7	18.0	17.3	16.6	16.0	15.4	14.7	14.1	13.5
20	25.0	23.2	22.4	21.6	20.8	20.0	19.2	18.4	17.6	16.8
25	31.5	29.5	28.3	27.2	26.0	25.0	24.0	22.7	21.7	20.7
32	41.0	37.8	36.5	34.9	33.3	32.0	30.7	29.1	27.8	26.5
40	51.0	48.0	46.0	44.0	42.0	40.0	38.0	36.0	34.0	32.0
50	64.0	60.0	57.5	55.0	52.5	50.0	47.5	45.0	42.5	40.0
63	80.6	75.6	72.5	69.9	66.1	63.0	59.8	56.1	52.9	49.7

Choice of DX³ MCBs for capacitor banks

This table shows the rated current of MCBs to be used when controlling capacitor banks so as to guarantee its function and shortcircuit protection.

Overload protection is not necessary since these installations cannot be overloaded.

This data refers to shortcircuit protection in absence of harmonics or heavy transitory currents.

Power of capacitor bank in kVAR	DX ³ MCB rating in amps			
	C characteristic		D characteristic	
	Single phase 240 V	Three phase 415 V	Single phase 240 V	Three phase 415 V
0,5	10	6	3	1
1	20	6	6	2
1.5	32	10	10	3
2.5	40	16	10	4
3	50	16	16	4
3.5	63	20	16	6
4	63	25	16	6
4.5	...	25	20	10
5	...	32	20	10
5.5	...	32	25	10
6	...	32	25	10
6.5	...	40	25	10
7	...	40	32	10
7.5	...	50	32	16
8	...	50	32	16
8.5	...	50	40	16
9	...	50	40	16
9.5	...	63	40	16
10	...	63	40	16
10.5	80	63	60	16
11	80	...	50	16
11.5	80	...	50	16
12	80	...	50	20
12.5	80	...	50	20
13	100	...	63	20
13.5	100	...	63	20
14	100	...	63	20
14.5	100	...	63	25
15	100	...	63	25
15.5	100	25
16	100	25
16.5	125	25
17	125	25
17.5	125	25
18	125	32
18.5	125	32
19	125	32
19.5	125	32
20	125	32
20.5	32
21	32
21.5	32
22	32
22.5	32
23	32
23.5	40
24	40
24.5	40
25	40
25.5	40
26	40
26.5	40
27	40
27.5	40
28	40
28.5	40
29	50
29.5	50
30	50
30.5	...	80	...	50
31	...	80	...	50
31.5	...	80	...	50
32	...	80	...	50
32.5	...	80	...	50
33	...	80	...	50
33.5	...	80	...	50
34	...	80	...	50
34.5	...	80	...	50
35	...	80	...	50
35.5	...	80	...	50
36	...	80	...	50
36.5	...	80	...	63
37	...	80	...	63
37.5	...	80	...	63
38	...	80	...	63
38.5	...	80	...	63
39	...	100	...	63
39.5	...	100	...	63
40	...	100	...	63
40.5	...	100	...	63
41	...	100	...	63
41.5	...	100	...	63
42	...	100	...	63
42.5	...	100	...	63
43	...	100	...	63
43.5	...	100	...	63
44	...	100	...	63
44.5	...	100	...	63
45	...	100	...	63
45.5 to 48	...	100
48.5 to 60	...	125

■ Technical data

Specification	SPEC/E-12/1/14
Number of poles	1
Characteristic	As applicable
Line terminal	Indicated by LN
Load terminal	Indicated by LD
Rated Voltage	130 V _~
Max. Operating Voltage	440 V _~
Min. Operating Voltage	12 V _~
Voltage resistance	> 2500 V _~
Enclosure	Moulded out of DMC (thermoset plastic) bone grey colour, flamability class V1-UL94, Tracking index - 600+volts
Dolly	Black, can be locked or lead sealed in ON or OFF position
Fire retardent grade of enclosure	V
Mounting position	Optional
Fixing	Snap fixing on standard DIN RAIL profile EN 50023 - 35 x 7.5
Terminals	With flat Cu terminal extension mounting as per skel 3700. Current Carrying Capacity 100 Amp. Max. Continuous.
On-Off indication	MCB in on position when marking I-ON appears on dolly. MCB in OFF position when making O-Off appears on dolly.
Mech. Service Life	10000 operation
Electrical Endurance	6000 operation at rated load
Climate resistance :	25/95-40/93 (°C/RH)
Permissible Ambient :	T max. - 45 °C, T min - 25 °C temperature
Shock resistance	20 g minimum 20 impacts duration of shock 13 ms.
Vibration resistance	3 g

As per international STD, MCB in 'ON' condition when dolly is in upper position.

DX³

MCBs

Technical data

Correct polarity connections for DC MCBs

• Supply terminals

When supply is given at lower terminals

Single pole MCB

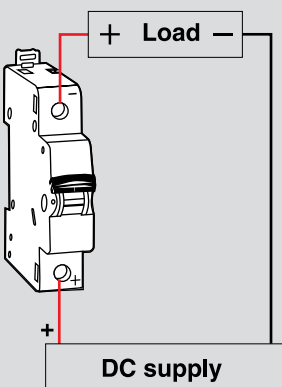

Double pole MCB

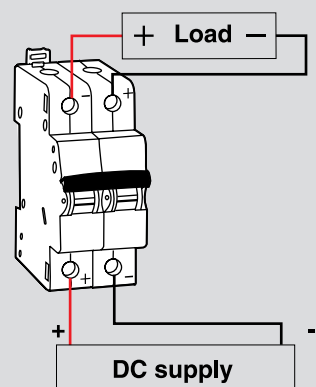

• Supply terminals

When supply is given at upper terminals

Single pole MCB

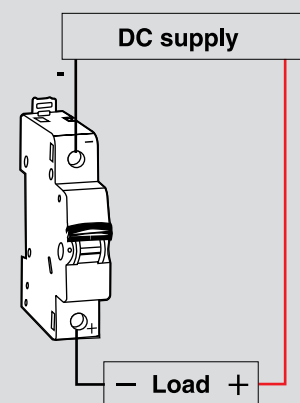

Double pole MCB

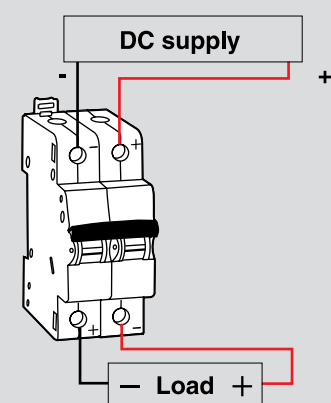

Derating of MCB for use with fluorescent lights

Ferromagnetic and electronic ballasts have a high inrush current for a short time. These currents can cause the tripping of circuit breakers. At the time of the installation, it should take into account the maximum number of ballasts per circuit breaker that the manufacturers of lamps and ballasts indicate in their catalogues.

Influence of the altitude

	≤2000 m	3000 m	4000 m	5000 m
Dielectric holding	3000 V	2500 V	2000 V	1500 V
Max operational voltage	400 V	400 V	400 V	400 V
Derating at 30 °C	none	none	none	none

Derating of MCBs function of the number of devices side by side:

When several MCBs are juxtaposed and operate simultaneously, the thermal evacuation of the poles is limited. This results in an increase in operating temperature of the circuit breakers which can cause unwanted tripping. It is recommended to apply the following coefficients to the rated currents.

Influence of the altitude

Number of circuit breakers side by side	Coefficient
2 - 3	0.9
4 - 5	0.8
6 - 9	0.7
≥10	0.6

These values are given by the recommendation of IEC 60439-1, NF C 63421 and EN 60439-1 standards.

Tripping characteristics

Standards has established different tripping characteristics depending on minimum and maximum values of magnetic trip.

DX ³ MCB	Type	Im1	Im2	Typical application
0.5 A to 63 A	D	10 In	20 In	Protection of cable and appliance which has very high starting currents.
6 A to 63 A	C	5 In	10 In	Protection of cable used for lighting load, power load and induction loads with high starting current.

Im1 - hold limit
Im2 - Trip limit

DX³ MCBs versus zero point extinguishing MCBs

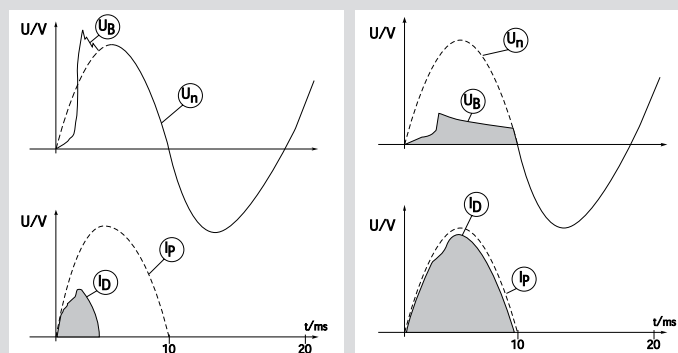

Current limiting DX³ MCB

Zero point extinguishing MCB

Un = Mains Voltage
UB = Arc Voltage
ID = Let-through short circuit current
IP = Prospective short circuit current

Technical data

Association of protection devices

Association is the technique by which the breaking capacity of a MCB is increased by coordinating it with another protection device, placed upstream. This coordination makes it possible to use a protection device with a breaking capacity which is lower than the maximum prospective short-circuit current at its installation point.

The breaking capacity of a protection device must be at least equal to the maximum short-circuit which may occur at the point at which this device is installed.

In exceptional cases, the breaking capacity may be lower than the maximum prospective short-circuit, as long as:

- It is associated with a device upstream which has the necessary breaking capacity at its own installation point
- The downstream device and the trunking being protected can withstand the power limited by the association of the devices.

Association therefore leads to substantial savings.

The association values given in the tables on the following pages are based on laboratory tests carried out in accordance with IEC 60947-2.

Note: In the case of single phase circuits (protected by P+N or 2P MCBs) in a 415 V AC supply, supplied upstream by a 3-phase circuit, it is advisable to use the association tables for 230 V.

Example of association

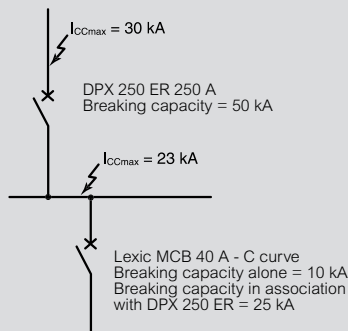

3-level association

An association may be created on three levels if one of the conditions below is met.

- The upstream device A must have an adequate breaking capacity at its installation point. Devices B and C are associated with device A. Simply check that the association values B+A and C+A have the necessary breaking capacity.

In this case, there is no need to check the association between devices B and C.

- The association is made between successive devices: Upstream device A, which has an adequate breaking capacity at its installation point, device C is associated with device B which is in turn associated with device A.

Simply check that the association values C+B and B+A have the necessary breaking capacity. In this case, there is no need to check the association between devices A and C.

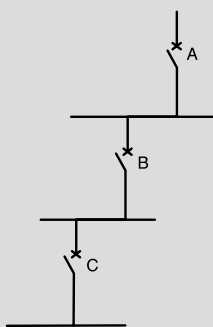

Association in IT connection systems

The values given in the tables should only be used for TN and TT systems.

Although this practice is not widely used, these values may also be used for installations with IT systems. It is therefore advisable to check that each protection device, on its own, can break, on a single pole, the maximum double fault current at the point in question.

Association between distribution boards

Association applies to devices installed in the same distribution board as well as in different boards. It is therefore generally possible to benefit from the advantages of the association between devices located, for example, in a main distribution board and in a secondary board.

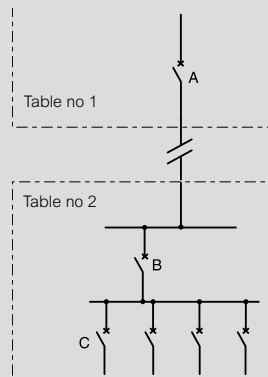

MCB - switch association

The switches must be systematically protected by an MCB placed upstream. There is considered to be protection against overloads if the rating of switch I is at least equal to that of the upstream MCB, D. If this is not the case, the thermal stresses (devices and conductors) must be checked. The tables on the following pages give the breaking capacity limits of the MCB - switch associations.

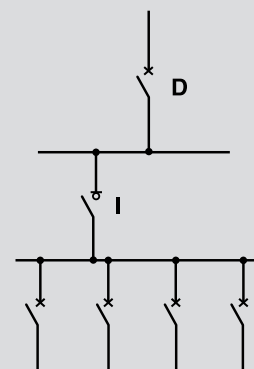

Discrimination of protection devices

Discrimination is a technique which consists of coordinating the protection in such a way that a fault on one circuit only trips the protection placed at the head of that circuit, thus avoiding rendering the remainder of the installation inoperative. Discrimination improves continuity of service and safety of the installation

Discrimination rules are set by the regulations concerning public buildings and for safety installations in general.

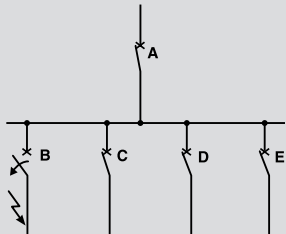

Discrimination between A and B is said to be "total" if it is provided up to the value of the maximum prospective short-circuit at the point at which B is installed.

By extension, in the tables on the following pages, total discrimination, indicated by T, means that there is discrimination up to the breaking capacity of device B.

Discrimination between A and B is said to be "partial" in the other cases.

The discrimination limit (given in the following tables) is therefore defined. This gives the short-circuit current value below which only MCB B will open and above which MCB A will also open.

There are a number of techniques for providing discrimination:

- Current discrimination, used for terminal circuits which have low short-circuits.
- Time discrimination, provided by a delay on tripping the upstream MCB
- Logical discrimination, a variant of time discrimination, used on electronic MCBs via a special link between the devices.

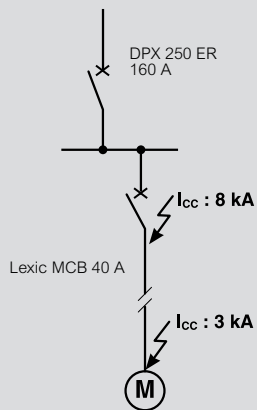

Since almost all faults occur during use, partial discrimination may be adequate if the discrimination limit is higher than the value of the maximum short-circuit which may occur at the point of use (or at the end of the trunking). This is referred to as "operating discrimination". This technique is very often adequate, more economical and less restricting in terms of implementation.

The discrimination limit for the association DPX 250 ER (160 A) with Lexic MCB 40 A (C curve) is 6 kA. Since the prospective is 8 kA, at the point of installation is 8 kA, the discrimination is not total. However, there is discrimination at the point of use at which the prospective short-circuit is only 3 kA.

Current discrimination

This technique is based on the offset of the intensity of the tripping curves of the upstream and downstream MCBs. It is checked by comparing these curves and checking that they do not overlap. It applies for the overload zone and the short-circuit zone, and the further apart the ratings of the devices, the better the discrimination.

- On overloads

To have discrimination in the overload zone, the ratio of the setting currents (I_r) must be at least 2.

- On short-circuits

To have discrimination in the short circuit zone, the ratio of the magnetic setting currents (I_m) must be at least 1.5.

The discrimination limit is then equal to the magnetic release current $I_m A$ of the upstream MCB. The discrimination is then total as long as I_{scB} is less than $I_m A$.

Current discrimination is therefore very suitable for terminal circuits where the short-circuits are relatively weak.

In other cases, time discrimination may be used together with current discrimination.

Current discrimination

The discrimination is total for I_{scB}

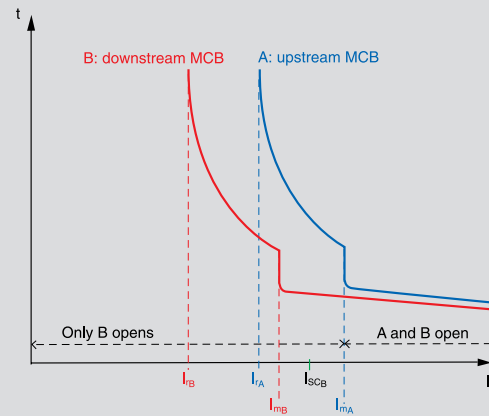

I_{scB} : maximum short-circuit at the point at which MCB B is installed

When the downstream MCB B is a limiting device, the short-circuit current is limited in terms of time and amplitude. The discrimination is therefore total if the limited current I_{scB} , which device B allows to pass, is lower than the tripping current of device A

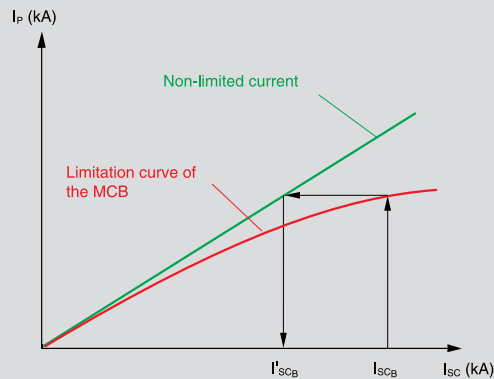

I_{scB} : prospective short-circuit at the point at which the device is installed
 I'_{scB} : short-circuit limited by device B

Time discrimination

This technique is based on the offset of the times of the tripping curves of the MCBs in series. It is checked by comparing the curves and is used for discrimination in the short-circuit zone. It is also used in addition to current discrimination in order to obtain discrimination beyond the magnetic setting current of the upstream MCB ($I_m A$).

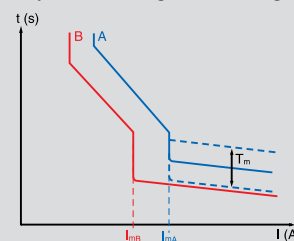

The following is necessary:

- It must be possible to set a time delay on the upstream MCB
- The upstream MCB must be able to withstand the short-circuit current and its effects for the whole period of the time delay
- The trunking through which this current passes must be able to withstand the thermal stresses (I^2t).

The non-tripping time of the upstream of the downstream device.

DPX MCBs have a number of time delay setting positions for creating discrimination with a number of stages.

Technical data
Coordination between Modular Circuit-Breakers and fuses, three-phase network (+ neutral) 400 / 415 V \sim according to standard IEC/EN 60947-2:

For TT or TN neutral system in 240/415 V network, to know the breaking capacity of the combination of a double pole breaker (connected between phase and neutral under 230 V) downstream of a triple-pole circuit-breaker, take the values shown in Tables 230/400 V.

MCB downstream		Fuse upstream									
		gG Type									
		≤20 A	25 A	32 A	40 A	50 A	63 A	80 A	100 A	125 A	160 A
DX ³ 10000 A/10 kA C and D curves	≤6 A	100 kA	100 kA	100 kA	100 kA	100 kA	100 kA	100 kA	100 kA	100 kA	40 kA
	10 A	100 kA	100 kA	100 kA	100 kA	100 kA	100 kA	100 kA	100 kA	100 kA	40 kA
	16 A	-	100 kA	100 kA	100 kA	100 kA	100 kA	100 kA	100 kA	100 kA	40 kA
	20 A	-	-	100 kA	100 kA	100 kA	100 kA	100 kA	100 kA	100 kA	40 kA
	25 A	-	-	-	100 kA	100 kA	100 kA	100 kA	100 kA	100 kA	40 kA
	32 A	-	-	-	-	100 kA	100 kA	100 kA	100 kA	100 kA	40 kA
	40 A	-	-	-	-	-	100 kA	100 kA	100 kA	100 kA	40 kA
	50 A	-	-	-	-	-	-	100 kA	100 kA	100 kA	40 kA
	63 A	-	-	-	-	-	-	-	100 kA	100 kA	40 kA

MCB downstream		Fuse upstream									
		aM Type									
		≤20 A	25 A	32 A	40 A	50 A	63 A	80 A	100 A	125 A	160 A
DX ³ 10000 A/10 kA C and D curves	≤6 A	100 kA	100 kA	100 kA	100 kA	100 kA	100 kA	100 kA	100 kA	100 kA	40 kA
	10 A	100 kA	100 kA	100 kA	100 kA	100 kA	100 kA	100 kA	100 kA	100 kA	40 kA
	16 A	-	100 kA	100 kA	100 kA	100 kA	100 kA	100 kA	100 kA	100 kA	40 kA
	20 A	-	-	100 kA	100 kA	100 kA	100 kA	100 kA	100 kA	100 kA	40 kA
	25 A	-	-	-	100 kA	100 kA	100 kA	100 kA	100 kA	100 kA	40 kA
	32 A	-	-	-	-	100 kA	100 kA	100 kA	100 kA	100 kA	40 kA
	40 A	-	-	-	-	-	100 kA	100 kA	100 kA	100 kA	40 kA
	50 A	-	-	-	-	-	-	100 kA	100 kA	100 kA	40 kA
	63 A	-	-	-	-	-	-	-	100 kA	100 kA	40 kA

All these values are also valid for circuit breakers associated to differential blocks.

According to the curves and ratings of circuit breakers, attention to the threshold and size of upstream fuse which must necessarily be higher.

Coordination between Modular Circuit-Breakers, three-phase network (+ neutral) 400 / 415 V \sim according to IEC/EN 60947-2:

For TT or TN neutral system in 230/400 V network, to know the breaking capacity of the combination of a double pole breaker (connected between phase and neutral under 230 V) downstream of a triple-pole circuit-breaker, take the values shown in Tables 230/400 V.

MCB downstream		MCB upstream							
		DX ³ 10000/16 kA C and D Curves							
		≤25 A	32 A	40 A	50 A	63 A	80 A	100 A	125 A
DX ³ 10000 A C Curves	≤6 A	16 kA	16 kA	16 kA	16 kA	16 kA	16 kA	16 kA	16 kA
	10 A	16 kA	16 kA	16 kA	16 kA	16 kA	16 kA	16 kA	16 kA
	16 A	16 kA	16 kA	16 kA	16 kA	16 kA	16 kA	16 kA	16 kA
	20 A	16 kA	16 kA	16 kA	16 kA	16 kA	16 kA	16 kA	16 kA
	25 A	-	16 kA	16 kA	16 kA	16 kA	16 kA	16 kA	16 kA
	32 A	-	-	16 kA	16 kA	16 kA	16 kA	16 kA	16 kA
	40 A	-	-	-	16 kA	16 kA	16 kA	16 kA	16 kA
	50 A	-	-	-	-	16 kA	16 kA	16 kA	16 kA
	63 A	-	-	-	-	-	16 kA	16 kA	16 kA

MCB downstream		MCB upstream							
		DX ³ 25 kA C and D Curves							
		≤25 A	32 A	40 A	50 A	63 A	80 A	100 A	125 A
DX ³ 10000 A C Curves	≤6 A	25 kA	25 kA	25 kA	25 kA	25 kA	25 kA	25 kA	25 kA
	10 A	25 kA	25 kA	25 kA	25 kA	25 kA	25 kA	25 kA	25 kA
	16 A	25 kA	25 kA	25 kA	25 kA	25 kA	25 kA	25 kA	25 kA
	20 A	25 kA	25 kA	25 kA	25 kA	25 kA	25 kA	25 kA	25 kA
	25 A	-	25 kA	25 kA	25 kA	25 kA	25 kA	25 kA	25 kA
	32 A	-	-	25 kA	25 kA	25 kA	25 kA	25 kA	25 kA
	40 A	-	-	-	25 kA	25 kA	25 kA	25 kA	25 kA
	50 A	-	-	-	-	25 kA	25 kA	25 kA	25 kA
	63 A	-	-	-	-	-	25 kA	25 kA	25 kA

All these values are also valid for circuit breakers associated to RCD add-on modules.

According to the curves and ratings of circuit breakers, attention to the magnetic threshold and to the size of upstream circuit breakers which must necessarily be higher.

Technical data
Coordination between Modular Circuit-Breakers, three-phase network (+ neutral) 400/415 V \sim according to IEC/EN 60947-2:

For TT or TN neutral system in 240/415 V network, to know the breaking capacity of the combination of a double pole breaker (connected between phase and neutral under 230 V) downstream of a triple-pole circuit-breaker, take the values shown in Tables 240/415 V.

MCB downstream		MCB upstream										
		DX ³ 36 kA						DX ³ 50 kA				
		C Curve						C and D Curves				
		≤25 A	32 A	40 A	50 A	63 A	80 A	≤25 A	32 A	40 A	50 A	63 A
DX ³ 10000 A C Curves	≤6 A	36 kA	36 kA	36 kA	36 kA	36 kA	36 kA	50 kA	50 kA	50 kA	50 kA	50 kA
	10 A	36 kA	36 kA	36 kA	36 kA	36 kA	36 kA	50 kA	50 kA	50 kA	50 kA	50 kA
	16 A	36 kA	36 kA	36 kA	36 kA	36 kA	36 kA	50 kA	50 kA	50 kA	50 kA	50 kA
	20 A	36 kA	36 kA	36 kA	36 kA	36 kA	36 kA	50 kA	50 kA	50 kA	50 kA	50 kA
	25 A	-	36 kA	36 kA	36 kA	36 kA	36 kA	-	50 kA	50 kA	50 kA	50 kA
	32 A	-	-	36 kA	36 kA	36 kA	36 kA	-	-	50 kA	50 kA	50 kA
	40 A	-	-	-	36 kA	36 kA	36 kA	-	-	-	50 kA	50 kA
	50 A	-	-	-	-	36 kA	36 kA	-	-	-	-	50 kA
	63 A	-	-	-	-	-	36 kA	-	-	-	-	-

All these values are also valid for circuit breakers associated to RCD add-on modules.

According to the curves and ratings of circuit breakers, attention to the magnetic threshold and to the size of upstream circuit breakers which must necessarily be higher.

Coordination between Modular Circuit-Breakers (MCB) and Moulded Case Circuit Breakers (MCCBs), three-phase network (+ neutral) 400 / 415 V \sim according to standard IEC/EN60947-2:

For TT or TN neutral system in 240/415 V network, to know the breaking capacity of the combination of a double pole breaker (connected between phase and neutral under 230 V) downstream of a triple-pole circuit-breaker, take the values shown in Tables 240/415 V.

MCB downstream		MCCB upstream							
		DPX ³ 160 / DPX ³ 160 + RCD							
		16 kA							
		16 A	25 A	40 A	63 A	80 A	100 A	125 A	160 A
DX ³ 10000 A/10 kA C and D curves	≤6 A	16 kA	16 kA	16 kA	16 kA	16 kA	16 kA	16 kA	16 kA
	10 A	16 kA	16 kA	16 kA	16 kA	16 kA	16 kA	16 kA	16 kA
	16 A	-	16 kA	16 kA	16 kA	16 kA	16 kA	16 kA	16 kA
	20 A	-	16 kA	16 kA	16 kA	16 kA	16 kA	16 kA	16 kA
	25 A	-	-	16 kA	16 kA	16 kA	16 kA	16 kA	16 kA
	32 A	-	-	16 kA	16 kA	16 kA	16 kA	16 kA	16 kA
	40 A	-	-	-	16 kA	16 kA	16 kA	16 kA	16 kA
	50 A	-	-	-	16 kA	16 kA	16 kA	16 kA	16 kA
	63 A	-	-	-	-	16 kA	16 kA	16 kA	16 kA

MCB downstream		MCCB upstream							
		DPX ³ 160 / DPX ³ 160 + RCD							
		25 - 36 - 50 kA							
		16 A	25 A	40 A	63 A	80 A	100 A	125 A	160 A
DX ³ 10000 A/10 kA C and D curves	≤6A	25 kA	25 kA	25 kA	25 kA	25 kA	25 kA	25 kA	25 kA
	10A	25 kA	25 kA	25 kA	25 kA	25 kA	25 kA	25 kA	25 kA
	16A	-	25 kA	25 kA	25 kA	25 kA	25 kA	25 kA	25 kA
	20A	-	25 kA	25 kA	25 kA	25 kA	25 kA	25 kA	36 kA
	25A	-	-	25 kA	25 kA	25 kA	25 kA	25 kA	25 kA
	32A	-	-	25 kA	25 kA	25 kA	25 kA	25 kA	25 kA
	40A	-	-	-	25 kA	25 kA	25 kA	25 kA	25 kA
	50A	-	-	-	25 kA	25 kA	25 kA	25 kA	25 kA
	63A	-	-	-	-	25 kA	25 kA	25 kA	25 kA

All these values are also valid for circuit breakers associated to differential blocks.

According to the curves and ratings of circuit breakers, attention to the magnetic threshold and to the size of upstream circuit breakers which must necessarily be higher.

Technical data
Coordination between Modular Circuit-Breakers (MCB) and Moulded Case Circuit Breakers (MCCBs), three-phase network (+ neutral) 400 / 415 V_~ according to standard IEC/EN60947-2:

For TT or TN neutral system in 240/415 V network, to know the breaking capacity of the combination of a double pole breaker (connected between phase and neutral under 230 V) downstream of a triple-pole circuit-breaker, take the values shown in Tables 240/415 V.

MCB downstream		MCCB upstream			
		DPX ³ 250 / DPX ³ 250+RCD (Thermal-Magnetic & Electronic)			
		25 - 36 - 50 kA - 70 kA			
	100A	160A	200A	250A	
DX ³ 10000 A/10 kA C and D curves	≤6 A	25 kA	25 kA	25 kA	25 kA
	10 A	25 kA	25 kA	25 kA	25 kA
	16 A	25 kA	25 kA	25 kA	25 kA
	20 A	25 kA	25 kA	25 kA	25 kA
	25 A	25 kA	25 kA	25 kA	25 kA
	32 A	25 kA	25 kA	25 kA	25 kA
	40 A	25 kA	25 kA	25 kA	25 kA
	50 A	25 kA	25 kA	25 kA	25 kA
	63 A	25 kA	25 kA	25 kA	25 kA

MCB downstream		MCCB upstream											
		DPX / H / L 250 (Thermal-Magnetic & electronic)						DPX 400AB		DPX / DPXH / DPXL 630 (Thermal-Magnetic & electronic)			
		36 - 70 - 100 kA						36 kA		36 - 70 - 100 kA			
	25A	40A	63A	100A	160A	250A	320A	400A	250A	320A	400A	500A	630A
DX ³ 10000 A/10 kA C and D curves	≤6 A	25 kA	25 kA	25 kA	25 kA	25 kA	25 kA	25 kA	25 kA	25 kA	25 kA	25 kA	25 kA
	10 A	25 kA	25 kA	25 kA	25 kA	25 kA	25 kA	25 kA	25 kA	25 kA	25 kA	25 kA	25 kA
	16 A	25 kA	25 kA	25 kA	25 kA	25 kA	25 kA	25 kA	25 kA	25 kA	25 kA	25 kA	25 kA
	20 A	25 kA	25 kA	25 kA	25 kA	25 kA	25 kA	25 kA	25 kA	25 kA	25 kA	25 kA	25 kA
	25 A	-	25 kA	25 kA	25 kA	25 kA	25 kA	25 kA	25 kA	25 kA	25 kA	25 kA	25 kA
	32 A	-	25 kA	25 kA	25 kA	25 kA	25 kA	25 kA	25 kA	25 kA	25 kA	25 kA	25 kA
	40 A	-	-	25 kA	25 kA	25 kA	25 kA	20 kA	20 kA	20 kA	20 kA	20 kA	20 kA
	50 A	-	-	25 kA	25 kA	25 kA	25 kA	20 kA	20 kA	20 kA	20 kA	20 kA	20 kA
	63 A	-	-	-	20 kA	20 kA	20 kA	20 kA	20 kA	20 kA	20 kA	20 kA	20 kA

All these values are also valid for circuit breakers associated to differential blocks.

According to the curves and ratings of circuit breakers, attention to the magnetic (or electronic) threshold and to the size of upstream circuit breakers which must necessarily be higher.

Coordination between Modular Circuit-Breakers (MCB) and Moulded Case Circuit Breakers (MCCBs), three-phase network (+ neutral) 400 / 415 V_~ according to standard IEC/EN60947-2:

For TT or TN neutral system in 240/415 V network, to know the breaking capacity of the combination of a double pole breaker (connected between phase and neutral under 230 V) downstream of a triple-pole circuit-breaker, take the values shown in Tables 240/415 V.

MCB downstream		MCCB upstream	
		DPX / H / L 1250 (Thermo-Magnetic)	DPX / H 1600 (Electronic)
		50 - 70 - 100 kA	36 - 70 kA
	500 to 1250A	630 to 1600A	
DX ³ 10000 A/10 kA C and D curves	≤6 A	25 kA	25 kA
	10 A	25 kA	25 kA
	16 A	25 kA	25 kA
	20 A	25 kA	25 kA
	25 A	20 kA	20 kA
	32 A	16 kA	16 kA
	40 A	16 kA	16 kA
	50 A	16 kA	16 kA
	63 A	16 kA	16 kA

All these values are also valid for circuit breakers associated to differential blocks.

According to the curves and ratings of circuit breakers, attention to the magnetic (or electronic) threshold and to the size of upstream circuit breakers which must necessarily be higher.

Coordination between Modular Circuit-Breakers and fuses, three-phase network (+ neutral) 230/240 V_~ according to standard IEC/EN 60947-2:

MCB downstream		Fuse upstream									
		gG Type									
		≤20 A	25 A	32 A	40 A	50 A	63 A	80 A	100 A	125 A	160 A
DX ³ 10000 A/10 kA C and D curves	≤6 A	100 kA	100 kA	100 kA	100 kA	100 kA	100 kA	100 kA	100 kA	100 kA	40 kA
	10 A	100 kA	100 kA	100 kA	100 kA	100 kA	100 kA	100 kA	100 kA	100 kA	40 kA
	16 A	-	100 kA	100 kA	100 kA	100 kA	100 kA	100 kA	100 kA	100 kA	40 kA
	20 A	-	-	100 kA	100 kA	100 kA	100 kA	100 kA	100 kA	100 kA	40 kA
	25 A	-	-	-	100 kA	100 kA	100 kA	100 kA	100 kA	100 kA	40 kA
	32 A	-	-	-	-	100 kA	100 kA	100 kA	100 kA	100 kA	40 kA
	40 A	-	-	-	-	-	100 kA	100 kA	100 kA	100 kA	40 kA
	50 A	-	-	-	-	-	-	100 kA	100 kA	100 kA	40 kA
	63 A	-	-	-	-	-	-	100 kA	100 kA	100 kA	40 kA

MCB downstream		Fuse upstream									
		aM Type									
		≤20 A	25 A	32 A	40 A	50 A	63 A	80 A	100 A	125 A	160 A
DX ³ 10000 A/10 kA C and D curves	≤6 A	100 kA	100 kA	100 kA	100 kA	100 kA	100 kA	100 kA	100 kA	100 kA	40 kA
	10 A	100 kA	100 kA	100 kA	100 kA	100 kA	100 kA	100 kA	100 kA	100 kA	40 kA
	16 A	-	100 kA	100 kA	100 kA	100 kA	100 kA	100 kA	100 kA	100 kA	40 kA
	20 A	-	-	100 kA	100 kA	100 kA	100 kA	100 kA	100 kA	100 kA	40 kA
	25 A	-	-	-	100 kA	100 kA	100 kA	100 kA	100 kA	100 kA	40 kA
	32 A	-	-	-	-	100 kA	100 kA	100 kA	100 kA	100 kA	40 kA
	40 A	-	-	-	-	-	100 kA	100 kA	100 kA	100 kA	40 kA
	50 A	-	-	-	-	-	-	100 kA	100 kA	100 kA	40 kA
	63 A	-	-	-	-	-	-	100 kA	100 kA	100 kA	40 kA

All these values are also valid for circuit breakers associated to differential blocks.

According to the curves and ratings of circuit breakers, attention to the threshold and to the size of upstream fuses which must necessarily be higher.

DX³

MCBs

Technical data

Coordination between modular circuit-breakers, three-phase network (+ neutral) 230/240 V_~ according to IEC/EN 60947-2:

MCB downstream		MCB upstream							
		DX ³ 10000/16 kA							
		B, C and D Curves							
		≤25 A	32 A	40 A	50 A	63 A	80 A	100 A	125 A
DX ³ 10000 A C Curves	≤6 A	32 kA	32 kA	25 kA	25 kA	25 kA	25 kA	25 kA	25 kA
	10 A	32 kA	32 kA	25 kA	25 kA	25 kA	25 kA	25 kA	25 kA
	16 A	32 kA	32 kA	25 kA	25 kA	25 kA	25 kA	25 kA	25 kA
	20 A	32 kA	32 kA	25 kA	25 kA	25 kA	25 kA	25 kA	25 kA
	25 A	-	32 kA	25 kA	25 kA	25 kA	25 kA	25 kA	25 kA
	32 A	-	-	25 kA	25 kA	25 kA	25 kA	25 kA	25 kA
	40 A	-	-	-	25 kA	25 kA	25 kA	25 kA	25 kA
	50 A	-	-	-	-	25 kA	25 kA	25 kA	25 kA
	63 A	-	-	-	-	-	25 kA	25 kA	25 kA

MCB downstream		MCB upstream							
		DX ³ 25 kA							
		B, C and D Curves							
		≤25 A	32 A	40 A	50 A	63 A	80 A	100 A	125 A
DX ³ 10000 A C Curves	≤6 A	50 kA	50 kA	25 kA	25 kA	25 kA	25 kA	25 kA	25 kA
	10 A	50 kA	50 kA	25 kA	25 kA	25 kA	25 kA	25 kA	25 kA
	16 A	50 kA	50 kA	25 kA	25 kA	25 kA	25 kA	25 kA	25 kA
	20 A	50 kA	50 kA	25 kA	25 kA	25 kA	25 kA	25 kA	25 kA
	25 A	-	50 kA	25 kA	25 kA	25 kA	25 kA	25 kA	25 kA
	32 A	-	-	25 kA	25 kA	25 kA	25 kA	25 kA	25 kA
	40 A	-	-	-	25 kA	25 kA	25 kA	25 kA	25 kA
	50 A	-	-	-	-	25 kA	25 kA	25 kA	25 kA
	63 A	-	-	-	-	-	25 kA	25 kA	25 kA

All these values are also valid for circuit breakers associated to RCD add-on modules.
According to the curves and ratings of circuit breakers, attention to the magnetic threshold and to the size of upstream circuit breakers which must necessarily be higher.

Coordination between Modular Circuit-Breakers, three-phase network (+ neutral) 230/240 V_~ according to IEC/EN 60947-2:

MCB downstream		MCB upstream										
		DX ³ 36 kA					DX ³ 50 kA					
		≤25 A	32 A	40 A	50 A	63 A	80 A	≤25 A	32 A	40 A	50 A	63 A
DX ³ 10000 A C Curves	≤6 A	50 kA	50 kA	50 kA	50 kA	50 kA	50 kA	50 kA	50 kA	50 kA	50 kA	50 kA
	10 A	50 kA	50 kA	50 kA	50 kA	50 kA	50 kA	50 kA	50 kA	50 kA	50 kA	50 kA
	16 A	50 kA	50 kA	50 kA	50 kA	50 kA	50 kA	50 kA	50 kA	50 kA	50 kA	50 kA
	20 A	50 kA	50 kA	50 kA	50 kA	50 kA	50 kA	50 kA	50 kA	50 kA	50 kA	50 kA
	25 A	-	50 kA	50 kA	50 kA	50 kA	50 kA	-	50 kA	50 kA	50 kA	50 kA
	32 A	-	-	50 kA	50 kA	50 kA	50 kA	-	-	50 kA	50 kA	50 kA
	40 A	-	-	-	50 kA	50 kA	50 kA	-	-	-	50 kA	50 kA
	50 A	-	-	-	-	50 kA	50 kA	-	-	-	-	50 kA
	63 A	-	-	-	-	-	50 kA	-	-	-	-	-

All these values are also valid for circuit breakers associated to RCD add-on modules.
According to the curves and ratings of circuit breakers, attention to the magnetic threshold and to the size of upstream circuit breakers which must necessarily be higher.

Coordination between Modular Circuit-Breakers (MCB) and Moulded Case Circuit Breakers (MCCBs), three-phase network (+ neutral) 230/240 V_~ according to standard IEC/EN 60947-2:

MCB downstream		MCCB upstream							
		DPX ³ 160 / DPX ³ 160 + RCD							
		16 kA							
		16 A	25 A	40 A	63 A	80 A	100 A	125 A	160 A
DX ³ 10000 A/10 kA C and D curves	≤6 A	28 kA	28 kA	28 kA	28 kA	28 kA	28 kA	28 kA	28 kA
	10 A	28 kA	28 kA	28 kA	28 kA	28 kA	28 kA	28 kA	28 kA
	16 A	-	28 kA	28 kA	28 kA	28 kA	28 kA	28 kA	28 kA
	20 A	-	28 kA	28 kA	28 kA	28 kA	28 kA	28 kA	28 kA
	25 A	-	-	28 kA	28 kA	28 kA	28 kA	28 kA	28 kA
	32 A	-	-	28 kA	28 kA	28 kA	28 kA	28 kA	28 kA
	40 A	-	-	-	28 kA	28 kA	28 kA	28 kA	28 kA
	50 A	-	-	-	28 kA	28 kA	28 kA	28 kA	28 kA
	63 A	-	-	-	-	28 kA	28 kA	28 kA	28 kA

All these values are also valid for circuit breakers associated to differential blocks.
According to the curves and ratings of circuit breakers, attention to the magnetic threshold and to the size of upstream circuit breakers which must necessarily be higher.

Technical data
Coordination between Modular Circuit-Breakers (MCB) and Moulded Case Circuit Breakers (MCCBs), three-phase network (+ neutral) 230/240 V_~ according to standard IEC/EN 60947-2:

MCB downstream		MCCB upstream							
		DPX ³ 160 / DPX ³ 160 + RCD							
		25 kA							
		16 A	25 A	40 A	63 A	80 A	100 A	125 A	160 A
DX ³ 10000 A/10 kA C and D curves	≤6 A	40 kA	40 kA	40 kA	40 kA	40 kA	40 kA	40 kA	40 kA
	10 A	40 kA	40 kA	40 kA	40 kA	40 kA	40 kA	40 kA	40 kA
	16 A	-	40 kA	40 kA	40 kA	40 kA	40 kA	40 kA	40 kA
	20 A	-	40 kA	40 kA	40 kA	40 kA	40 kA	40 kA	40 kA
	25 A	-	-	40 kA	40 kA	40 kA	40 kA	40 kA	40 kA
	32 A	-	-	40 kA	40 kA	40 kA	40 kA	40 kA	40 kA
	40 A	-	-	-	40 kA	40 kA	40 kA	40 kA	40 kA
	50 A	-	-	-	40 kA	40 kA	40 kA	40 kA	40 kA
	63 A	-	-	-	-	40 kA	40 kA	40 kA	40 kA

MCB downstream		MCCB upstream							
		DPX ³ 160 / DPX ³ 160 + RCD							
		36 - 50 kA							
		16 A	25 A	40 A	63 A	80 A	100 A	125 A	160 A
DX ³ 10000 A/10 kA C and D curves	≤6 A	50 kA	50 kA	50 kA	50 kA	50 kA	50 kA	50 kA	50 kA
	10 A	50 kA	50 kA	50 kA	50 kA	50 kA	50 kA	50 kA	50 kA
	16 A	-	50 kA	50 kA	50 kA	50 kA	50 kA	50 kA	50 kA
	20 A	-	50 kA	50 kA	50 kA	50 kA	50 kA	50 kA	50 kA
	25 A	-	-	50 kA	50 kA	50 kA	50 kA	50 kA	50 kA
	32 A	-	-	50 kA	-	50 kA	50 kA	50 kA	50 kA
	40 A	-	-	-	50 kA	50 kA	50 kA	50 kA	50 kA
	50 A	-	-	-	50 kA	50 kA	50 kA	50 kA	50 kA
	63 A	-	-	-	-	50 kA	50 kA	50 kA	50 kA

All these values are also valid for circuit breakers associated to differential blocks.
According to the curves and ratings of circuit breakers, attention to the magnetic threshold and to the size of upstream circuit breakers which must necessarily be higher.

Coordination between Modular Circuit-Breakers (MCB) and Moulded Case Circuit Breakers (MCCBs), three-phase network (+ neutral) 230/240 V_~ according to standard IEC/EN 60947-2:

MCB downstream		MCCB upstream			
		DPX ³ 250 / DPX ³ 250+RCD (Thermal-magnetic & electronic)			
		25 kA			
		100 A	160 A	200 A	250 A
DX ³ 10000 A/10 kA C and D curves	≤6 A	40 kA	40 kA	40 kA	40 kA
	10 A	40 kA	40 kA	40 kA	40 kA
	16 A	40 kA	40 kA	40 kA	40 kA
	20 A	40 kA	40 kA	40 kA	40 kA
	25 A	40 kA	40 kA	40 kA	40 kA
	32 A	40 kA	40 kA	40 kA	40 kA
	40 A	40 kA	40 kA	40 kA	40 kA
	50 A	40 kA	40 kA	40 kA	40 kA
	63 A	40 kA	40 kA	40 kA	40 kA

All these values are also valid for circuit breakers associated to differential blocks.

DX³

MCBs

Technical data

Coordination between Modular Circuit-Breakers (MCB) and Moulded Case Circuit Breakers (MCCBs), three phase network (+ neutral) 230/240 V_~ according to standard IEC/EN 60947-2:

MCB downstream		MCCB upstream									
		DPX ³ 250 / DPX ³ 250+RCD (Thermal-magnetic & electronic)					DPX / H / L 250 (Thermal-magnetic & electronic)				
		36 - 50 - 70 kA					36 - 70 - 100 kA				
MCB downstream		100 A	160 A	200 A	250 A	25 A	40 A	63 A	100 A	160 A	250 A
DX ³ 10000 A/10 kA C and D curves	≤6 A	50 kA	50 kA	50 kA	50 kA	50 kA	50 kA	50 kA	50 kA	50 kA	50 kA
	10 A	50 kA	50 kA	50 kA	50 kA	50 kA	50 kA	50 kA	50 kA	50 kA	50 kA
	16 A	50 kA	50 kA	50 kA	50 kA	50 kA	50 kA	50 kA	50 kA	50 kA	50 kA
	20 A	50 kA	50 kA	50 kA	50 kA	50 kA	50 kA	50 kA	50 kA	50 kA	50 kA
	25 A	50 kA	50 kA	50 kA	50 kA	-	50 kA	50 kA	50 kA	50 kA	50 kA
	32 A	50 kA	50 kA	50 kA	50 kA	-	50 kA	50 kA	50 kA	50 kA	50 kA
	40 A	50 kA	50 kA	50 kA	50 kA	-	-	50 kA	50 kA	50 kA	50 kA
	50 A	50 kA	50 kA	50 kA	50 kA	-	-	50 kA	50 kA	50 kA	50 kA
	63 A	50 kA	50 kA	50 kA	50 kA	-	-	-	50 kA	50 kA	50 kA

MCB downstream		MCCB upstream						
		DPX 400AB			DPX / DPXH / DPXL 630MT (Thermal-magnetic & electronic)			
		36 kA			36 - 70 - 100 kA			
MCB downstream		320 A	400 A	250 A	320 A	400 A	500 A	630 A
DX ³ 10000 A/10 kA C and D curves	≤6 A	50 kA	50 kA	50 kA	50 kA	50 kA	50 kA	50 kA
	10 A	50 kA	50 kA	50 kA	50 kA	50 kA	50 kA	50 kA
	16 A	50 kA	50 kA	50 kA	50 kA	50 kA	50 kA	50 kA
	20 A	50 kA	50 kA	50 kA	50 kA	50 kA	50 kA	50 kA
	25 A	50 kA	50 kA	50 kA	50 kA	50 kA	50 kA	50 kA
	32 A	50 kA	50 kA	50 kA	50 kA	50 kA	50 kA	50 kA
	40 A	50 kA	50 kA	50 kA	50 kA	50 kA	50 kA	50 kA
	50 A	36 kA	36 kA	36 kA	36 kA	36 kA	36 kA	36 kA
	63 A	36 kA	36 kA	36 kA	36 kA	36 kA	36 kA	36 kA

All these values are also valid for circuit breakers associated to differential blocks.
According to the curves and ratings of circuit breakers, attention to the magnetic (or electronic) threshold and to the size of upstream circuit breakers which must necessarily be higher.

Coordination between Modular Circuit-Breakers(MCB) and Moulded Case Circuit Breakers (MCCBs), three phase network (+ neutral) 230/240 V_~ according to standard IEC/EN 60947-2:

MCB downstream		MCCB upstream	
		DPX / H / L 1250 (Thermal-magnetic)	DPX / H 1600 (electronic)
		50 - 70 - 100 kA	36 - 70 kA
MCB downstream		500 to 1250 A	630 to 1600 A
DX ³ 10000 A/10 kA C and D curves	≤6 A	50 kA	50 kA
	10 A	50 kA	50 kA
	16 A	50 kA	50 kA
	20 A	50 kA	50 kA
	25 A	50 kA	50 kA
	32 A	50 kA	50 kA
	40 A	50 kA	50 kA
	50 A	36 kA	36 kA
	63 A	36 kA	36 kA

All these values are also valid for circuit breakers associated to differential blocks.
According to the curves and ratings of circuit breakers, attention to the magnetic (or electronic) threshold and to the size of upstream circuit breakers which must necessarily be higher.

Selectivity between two levels of protection

- The downstream circuit breaker must always have a magnetic threshold and a rated current lower than those of the upstream protection.
- Selectivity is indicated total (T) if there is selectivity up to the value of breaking capacity (according to IEC / EN 60947-2) of the downstream circuit breaker.

Selectivity between modular circuits breakers and fuses:

- Selectivity limit at 400 V_~: values in Ampere.

MCB downstream		Fuse upstream							
		gG Type							
		32 A	40 A	50 A	63 A	80 A	100 A	125 A	160 A
DX ³ 10000 A/10 kA C and D curves	≤6 A	1300	1900	2500	4000	4600	11000	T	T
	10 A	-	1600	2200	3200	3600	7000	11000	T
	16 A	-	1400	1800	2600	3000	5600	8000	15000
	20 A	-	1200	1500	2200	2500	4600	6300	10000
	25 A	-	-	1300	2000	2200	4100	5500	9000
	32 A	-	-	1200	1700	1900	3500	4500	8000
	40 A	-	-	-	-	1700	3000	4000	6000
	50 A	-	-	-	-	16000	2600	3500	5000
	63 A	-	-	-	-	-	2400	3300	5000

MCB downstream		Fuse upstream								
		aM Type								
		25 A	32 A	40 A	50 A	63 A	80 A	100 A	125 A	160 A
DX ³ 10000 A/10 kA C and D curves	≤6 A	1000	1600	2100	3200	6200	15000	T	T	T
	10 A	-	1100	1700	2500	5000	7800	12000	T	T
	16 A	-	1000	1400	2100	4000	6000	9000	T	T
	20 A	-	-	1300	1800	3400	5100	7000	14000	T
	25 A	-	-	1100	1600	3000	4500	6000	9300	14000
	32 A	-	-	-	1300	2400	3800	5000	7700	9000
	40 A	-	-	-	-	2100	3100	4200	6400	7000
	50 A	-	-	-	-	2000	2900	3700	6000	6000
	63 A	-	-	-	-	-	2800	3500	5500	6000

T = Total discrimination

Technical data
Selectivity between modular circuits breakers:

 Selectivity limit at 400 V \sim : values in Ampere.

MCB downstream		MCB upstream										
		DX ³ 25 kA										
		10 A	16 A	20 A	25 A	32 A	40 A	50 A	63 A	80 A	100 A	125 A
DX ³ 10000 A/10 kA C and D curves	≤6 A	40	64	80	100	700	1200	1500	3000	4000	T	T
	10 A	-	64	80	100	500	700	1000	1800	3000	5000	T
	16 A	-	-	80	100	300	500	700	1300	2000	3600	5500
	20 A	-	-	-	100	-	400	500	1000	1600	3000	4000
	25 A	-	-	-	-	-	-	500	800	1300	2400	3300
	32 A	-	-	-	-	-	-	500	600	1000	1800	2700
	40 A	-	-	-	-	-	-	-	600	800	1600	2400
	50 A	-	-	-	-	-	-	-	-	800	900	1700
	63 A	-	-	-	-	-	-	-	-	-	900	1200

MCB downstream		MCB upstream										
		DX ³ 25 kA										
		10 A	16 A	20 A	25 A	32 A	40 A	50 A	63 A	80 A	100 A	125 A
DX ³ 10000 A/10 kA C and D curves	≤6 A	75	120	150	187	700	1200	1500	3000	4000	T	T
	10 A	-	120	150	187	500	700	1000	1800	3000	5000	T
	16 A	-	-	150	187	300	500	700	1300	2000	3600	5500
	20 A	-	-	-	187	300	400	500	1000	1600	3000	4000
	25 A	-	-	-	-	240	400	500	800	1300	2400	3300
	32 A	-	-	-	-	-	300	500	600	1000	1800	2700
	40 A	-	-	-	-	-	-	400	600	800	1600	2400
	50 A	-	-	-	-	-	-	-	500	800	900	1700
	63 A	-	-	-	-	-	-	-	-	650	900	1200

T = Total discrimination

Selectivity between modular circuits breakers:

 Selectivity limit at 400 V \sim : values in Ampere.

MCB downstream		MCB upstream										
		DX ³ 25 kA										
		10 A	16 A	20 A	25 A	32 A	40 A	50 A	63 A	80 A	100 A	125 A
DX ³ 10000 A/10 kA C and D curves	≤6 A	120	192	240	500	700	1200	1500	3000	4000	T	T
	10 A	-	192	240	300	500	700	1000	1800	3000	5000	T
	16 A	-	-	240	300	384	500	700	1300	2000	3600	5500
	20 A	-	-	-	300	384	480	600	1000	1600	3000	4000
	25 A	-	-	-	-	384	480	600	800	1300	2400	3300
	32 A	-	-	-	-	-	480	600	756	1100	1450	2700
	40 A	-	-	-	-	-	-	600	756	1000	1250	2400
	50 A	-	-	-	-	-	-	-	756	950	1200	1700
	63 A	-	-	-	-	-	-	-	-	950	1200	1500

MCB downstream		MCB upstream										
		DX ³ 36 kA										
		10 A	16 A	20 A	25 A	32 A	40 A	50 A	63 A	80 A		
DX ³ 10000 A/10 kA C and D curves	≤6 A	75	120	170	500	700	1200	1500	3000	4000		
	10 A	-	120	150	210	500	700	1000	1800	3000		
	16 A	-	-	150	187	300	500	700	1300	2000		
	20 A	-	-	-	187	300	400	500	1000	1600		
	25 A	-	-	-	-	240	400	500	800	1300		
	32 A	-	-	-	-	-	300	500	600	1000		
	40 A	-	-	-	-	-	-	400	600	800		
	50 A	-	-	-	-	-	-	-	500	800		
	63 A	-	-	-	-	-	-	-	-	650		

T = Total discrimination

DX³

MCBs

Technical data

Selectivity between modular circuits breakers:

Selectivity limit at 415 V_~: values in Ampere.

MCB downstream		MCB upstream							
		DX ³ 50 kA							
		10 A	16 A	20 A	25 A	32 A	40 A	50 A	63 A
DX ³ 10000 A/10 kA C and D curves	≤6 A	-	64	170	500	700	1200	1500	3000
	10 A	-	-	150	210	500	700	1000	1800
	16 A	-	-	-	-	300	500	700	1300
	20 A	-	-	-	-	-	400	500	1000
	25 A	-	-	-	-	-	-	500	800
	32 A	-	-	-	-	-	-	500	600
	40 A	-	-	-	-	-	-	-	600
	50 A	-	-	-	-	-	-	-	-
	63 A	-	-	-	-	-	-	-	-

MCB downstream		MCB upstream							
		DX ³ 50 kA							
		10 A	16 A	20 A	25 A	32 A	40 A	50 A	63 A
DX ³ 10000 A/10 kA C and D curves	≤6 A	75	120	170	500	700	1200	1500	3000
	10 A	-	120	150	210	500	700	1000	1800
	16 A	-	-	150	187	300	500	700	1300
	20 A	-	-	-	187	300	400	500	1000
	25 A	-	-	-	-	240	400	500	800
	32 A	-	-	-	-	-	300	500	600
	40 A	-	-	-	-	-	-	400	600
	50 A	-	-	-	-	-	-	-	500
	63 A	-	-	-	-	-	-	-	-

Selectivity between modular circuits breakers:

Selectivity limit at 415 V_~: values in Ampere.

MCB downstream		MCB upstream							
		DX ³ 50 kA							
		10 A	16 A	20 A	25 A	32 A	40 A	50 A	63 A
DX ³ 10000 A/10 kA C and D curves	≤6 A	120	192	240	500	700	1200	1500	3000
	10 A	-	192	240	300	500	700	1000	1800
	16 A	-	-	240	300	384	500	700	1300
	20 A	-	-	-	300	384	480	600	1000
	25 A	-	-	-	-	384	480	600	800
	32 A	-	-	-	-	-	480	600	756
	40 A	-	-	-	-	-	-	600	756
	50 A	-	-	-	-	-	-	-	756
	63 A	-	-	-	-	-	-	-	-

Selectivity between modular circuits breakers (MCB) and Moulded Case Circuit Breakers (MCCBs):

Selectivity limit at 415 V_~: values in Ampere.

MCB downstream		MCCB upstream							
		DPX ³ 160 DPX ³ 160 + RCD							
		16 - 25 - 36 - 50 kA							
		16 A	25 A	40 A	63 A	80 A	100 A	125 A	160 A
DX ³ 10000 A/ 10 kA C and D curves	≤6 A	6000	12000	12000	T	T	T	T	T
	10 A	5000	7000	7000	7000	T	T	T	T
	16 A	-	6000	6000	6000	6000	T	T	T
	20 A	-	5000	5000	5000	5000	6000	T	T
	25 A	-	-	4500	4500	4500	4500	8500	T
	32 A	-	-	-	3000	4000	4000	7000	10000
	40 A	-	-	-	3000	3000	3000	6000	8000
	50 A	-	-	-	-	3000	3000	5500	7000
	63 A	-	-	-	-	3000	3000	5000	6000

T = Total discrimination

Selectivity between modular circuits breakers (MCB) and Moulded Case Circuit Breakers (MCCBs):

Selectivity limit at 415 V_~: values in Ampere.

MCB downstream		MCCB upstream							
		DPX ³ 250 DPX ³ 250 + diff (Thermo-magnetic & electronic)			DPX 400 AB		DPX / H / L 1250 (Thermo-magnetic)	DPX / H 1600 (electronic)	
		25 - 36 - 50 - 70 kA			36 kA		50 - 70 - 100 kA	36 - 70 kA	
		100 A	160 A	200 A	250 A	320 A	400 A	500 to 1250 A	630 to 1600 A
DX ³ 10000 A/10 kA C and D curves	≤6 A	T	T	T	T	T	T	T	T
	10 A	T	T	T	T	T	T	T	T
	16 A	T	T	T	T	T	T	T	T
	20 A	T	T	T	T	T	T	T	T
	25 A	T	T	T	T	T	T	T	T
	32 A	5000	T	T	T	T	T	T	T
	40 A	5000	T	T	T	T	T	T	T
	50 A	4000	T	T	T	T	T	T	T
	63 A	4000	T	T	T	T	T	T	T

Technical data

Time current characteristics for C curve

Rating - 6 to 63 A Ref. calibration Temp. : 30 °C
 Ref. standard : IS / IEC 60898-1

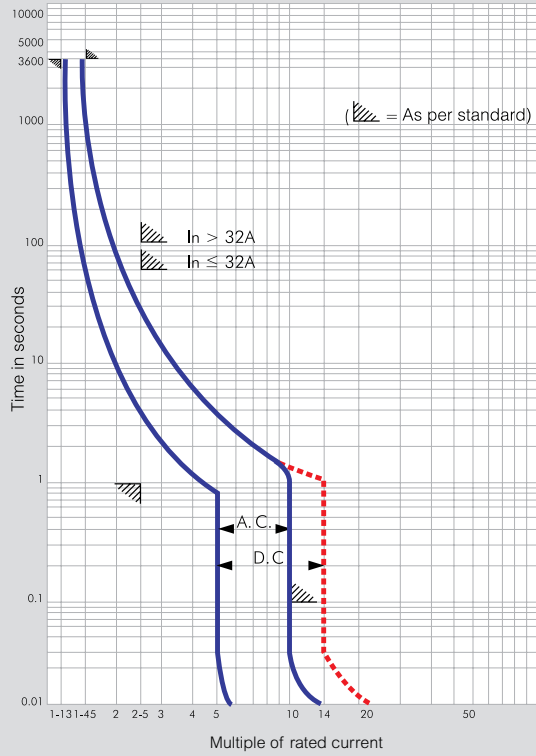

Time current characteristics for 80-125 A

Rating - 80 A to 125 A Ref. calibration Temp. : 30 °C
 Ref. standard : IEC 60947-2

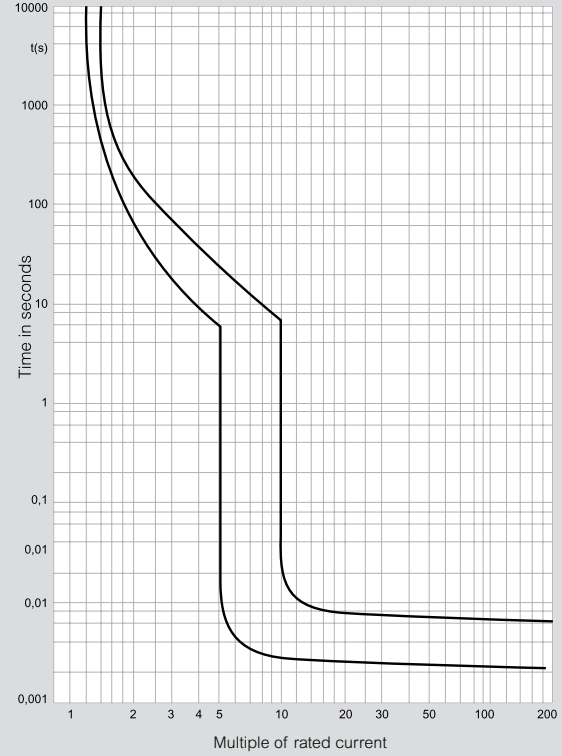

Time current characteristics for D curve

Rating - 0.5 to 63 A Ref. calibration Temp. : 30 °C
 Ref. standard : IS / IEC 60898-1

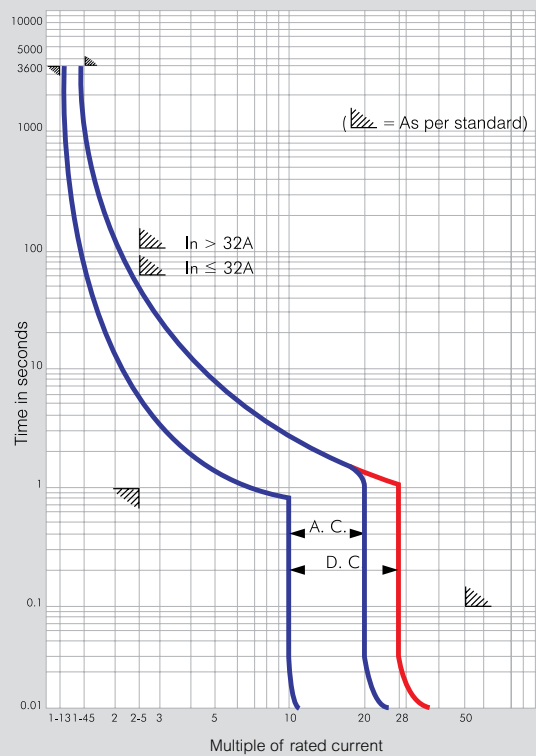

Selection chart*

 DX³ MCBs (10 kA) and RCBOs 3 phase motor application

Motor H.P.	KW	MCB rating (A)	
		Star Delta	DOL
1	0.75	-	1.6 A
1.5	1.10	-	2 A
2	1.50	-	3 A
3	2.25	-	4 A
4	3.00	-	10 A
5	3.75	10 A	10 A
6	4.50	10 A	10 A
7.5	5.50	16 A	16 A
10	7.50	16 A	20 A
12.5	9.30	20 A	25 A
15	11.00	25 A	32 A
17.5	13.00	25 A	32 A
20	15.00	40 A	40 A
25	18.50	40 A	50 A
30	22.50	50 A	63 A
35	26.00	63 A	-

For MCB/RCBO ratings :

 Single phase = $P = VI$

 Three phase = $P = \sqrt{3} VI \cos \phi = 1.732 \times VI \times 0.8$

Note : One lighting circuit can have upto 800 W or upto 10 points.

One power circuit can have upto 3000 W or upto 2 power points.

* The data given above is only for guidance.

The exact rating must be selected only after considering the motor characteristics.

Technical data
Isolators

Specifications	IEC 60947-3	
Number of poles	DP, TP, FP	
Utilization category	AC22A	
Rated operational voltage and frequency	415 V, 50/60 Hz	
Insulation voltage Ui	500 V AC	
Impulse voltage Uimp	6 kV	
Short circuit making capacity Icm	1000 A	
Endurance	Electrical - 1500 operations with load AC22A Mechanical - 10000 operation	
Mounting position	Vertical / Horizontal / Upside down / On the side	
Fixing	On symmetric rail EN/IEC 60715 or DIN 35	
Maximum cable size	Top/Bottom	1 x 1.5 mm ² to 35 mm ²
	Rigid cable	2 x 1.5 mm ² to 16 mm ²
	Top/Bottom	1 x 1.5 mm ² to 25 mm ²
Flexible cable	2 x 1.5 mm ² to 10 mm ²	
Applied connection torque	Recommended : 3 Nm Minimum : 2 Nm Maximum: 3.5 Nm	
Permissible ambient temperature	Maximum + 70 °C Minimum -25 °C	

DX³ RCDS

Technical data for DX³ RCDs

	RCCB		
	Type AC	Type A-S	Type Hpi
Specification	IS 12640 (part 1) 2008 IEC 61008 - 1	IEC 61008 - 1 EN 61008 - 1	EN 61008 - 1 IEC 61008 - 1
No. of modules	- Double pole - Four pole	2 4	2 4
Electrical characteristics			
Nominal rating I_n (A)	- Double pole - Four pole	25, 40, 63, 80, 100 25, 40, 63, 80, 100	63, 80 25, 40, 63, 80
Rated sensitivity (mA)	- Double pole - Four pole	30, 100, 300 30, 100, 300	300 300
Rated frequency (Hz)		50 / 60	50 / 60
Rated operating voltage U_e (V AC)	- Double pole - Four pole	230 230 / 415	230 400
Minimum operating voltage (V AC)		12	12
Minimum operating voltage for test button (V AC)⁽¹⁾	- Double pole - Four pole	170 196	170 196
Rated insulation voltage U_i (V AC)	- Double pole - Four pole	250 500	250 500
Rated impulse withstand voltage U_{imp} (kV)		6	6
Breaking capacity	As per IS 12640 (part 1) 2008, IEC 61008 - 1		
Rated making & breaking capacity (I_m)	- Up to 40 A - From 63 A and above	500 A 10 x I _n	- 630 A
Rated residual making & breaking capacity (I_{Δm})	- Up to 40 A - From 63 A and above	1000 A 1000 A	- 1000 A
Rated conditional short circuit current (I_{nc})		10000 A	10000 A
Rated conditional residual short circuit current (I_{Δc})		10000 A	10000 A
Rated service short circuit capacity (I_{cs})		-	-
Rated short circuit capacity (I_{cn})		-	-
Operating temperature (°C)		- 25 to 70	- 25 to 70
Endurance (0.C cycle)	- Mechanical - On load at in X cos φ 0.9 - Via test button - By fault current (sensitivity)	20,000 10,000 2,000 2,000	20,000 10,000 2,000 2,000
Testing		By pressing test button grey dolly will come to OFF position It is recommended to test RCCB once a month	By pressing test button, grey dolly will come to OFF position It is recommended to test RCCB once a month
Fault indication	- Earth leakage - Overload and shortcut	Grey dolly will come to OFF position -	Grey dolly will come to OFF position -
Resetting		Switch on grey dolly	Switch on grey dolly
Terminals	- Rigid - Flexible	1 - 35 sq. mm 1 - 25 sq. mm	1 - 35 sq. mm 1 - 25 sq. mm
Type of protection			
Earth leakage		•	•
Overload		-	-
Short circuit		-	-
Add on electrical accessories*			
Auxiliary		•	•
Fault signaling		•	•
Shunt trip		•	•
Under voltage		•	•
Over voltage		•	•

* - Accessories are mounted on the left hand side of the product.
At a time a maximum of three accessories can be mounted.

⁽¹⁾ - Between phase and neutral

RCBO				
Type AC	Type AC - 2 & 4 modules	Type Hpi	Type A	
IS 12640 (part 2) 2008 IEC 61009 - 1	NFC 61 - 410 EN 61009 - 1 IEC 61009 - 1	EN 61009 - 1 IEC 61009 - 1	EN 61009 - 1 IEC 61009 - 1	
4	2	2	-	
7	4	-	4	
6, 10, 16, 25, 32, 40, 63	6, 10, 16, 20, 25, 32	25, 32, 40	25, 32, 40	
16, 25, 32, 40, 63	10, 16, 20, 25, 32	-	-	
30, 100, 300	30, 300	30	30, 300	
30, 100, 300	-	-	-	
50	50	50 / 60	50 / 60	
230	230	230	-	
415	415	-	415	
12	12	12	12	
170	170	170	-	
196	196	-	196	
500	250	250	-	
500	500	-	500	
4	6	6	6	
As per IS 12640 (part 2) 2008, IEC 61009 - 1				
10000 A	6000 A	6000 A	6000 A	
10000 A	-	-	-	
10000 A	3000 A	3000 A	3000 A	
10000 A	-	-	-	
-	-	-	-	
-	-	-	-	
7500 A	6000 A	6000 A	6000 A	
10000 A	6000 A	6000 A	6000 A	
- 25 to 70	- 25 to 70	- 25 to 70	- 25 to 70	
20,000	20,000	20,000	20,000	
10,000	10,000	10,000	10,000	
1,000	1,000	1,000	1,000	
1,000	1,000	1,000	1,000	
By pressing test button, black dolly will come to OFF position It is recommended to test RCBO once a month	By pressing test button, black dolly will come to OFF position It is recommended to test RCBO once a month	By pressing test button, black dolly will come to OFF position It is recommended to test RCBO once a month	By pressing test button, black dolly will come to OFF position It is recommended to test RCBO once a month	
Black & blue dolly will come to OFF position	Black dolly will come to OFF position & blue indicator will appear on front face window	Black dolly will come to OFF position & blue indicator will appear on front face window	Black dolly will come to OFF position & blue indicator will appear on front face window	
Black dolly will come to OFF position	Black dolly will come to OFF position	Black dolly will come to OFF position	Black dolly will come to OFF position	
Switch on black dolly	Switch on black dolly	Switch on black dolly	Switch on black dolly	
1 - 35 sq. mm	0.75 - 16 sq. mm	0.75 - 16 sq. mm	0.75 - 16 sq. mm	
1 - 25 sq. mm	0.75 - 10 sq. mm	0.75 - 10 sq. mm	0.75 - 10 sq. mm	
•	•	•	•	
•	•	•	•	
•	•	•	•	
•	•	•	•	
•	•	•	•	
•	•	•	•	
•	•	•	•	
•	•	•	•	

Technical data
Short-circuit withstanding capacity of RCCBs (in kA)

RCD downstream	DX ³ MCB upstream	
2P	16	10
	25	10
	40	10
	63	10
	80	10
4P	100	10
	25	10
	40	10
	63	10
	80	10
	100	10

Marking example :
Type A

Type AC

Type A-S

Type Hpi

Technical data
Nature and consequences of electrical risks
Direct and indirect contact

All electrical risks for people are the result of direct or indirect contact. What are these contacts? And how can we protect ourselves against them?

All the answers appear in the following section.

Electrical risks do not just concern people : these risks - especially fire affect installations as well. A 500 mA current, for example, flowing through combustible material is sufficient to ignite such material after a certain time. Every electrical installation is subject to current leakages which can vary considerably depending on such factors as the installation's condition, age, environment, etc.

These current leaks may flow through the fabric of the building (trunking, metal girders or other metal components), generating heat which in turn may lead to fire.

Direct contacts

Direct contact is caused by humans and may be due to either carelessness or clumsiness.

What is a direct contact? How can we protect ourselves? Here are the answers...

This is when someone makes contact with a live electrical component of a device or installation.

For example :

- a person inadvertently touching a live cable.
- a child sticking a metal object into a power socket.
- using male/male extensions or unprotected test cables.

In this case only basic protection is effective

Other examples

Someone touching a live busbar in a distribution panel or cabinet, or someone touching flush-mounted electrical trunking with the end of a tool, etc. In this case basic protection plus additional protection is effective.

How can we protect ourselves?

There are two ways (independent of the neutral earthing system) of ensuring that personnel are protected against direct contact.

• Preventing access to live parts where possible.

Basic protection via physical or electrical isolation of live parts.

This protection must ensure that live parts cannot be touched, even inadvertently.

How?

By using barriers, enclosures, closed cabinets which physically or electrically isolate live parts presenting a danger to the user, shuttered sockets, or insulation.

• Additional protection

Must be provided by a 30-mA residual current device such as Lexic range of residual current devices. This protection is required in case the basic protection detailed above fails.

Technical data

Indirect contacts

Indirect contacts are independent of humans : it results from an internal hardware fault.

What is an indirect contact?

How can we protect ourselves? Here are the answers...

What is an indirect contact?

This is when a person makes contact with a metal earthed part which has accidentally been powered up following an insulation fault. This type of contact is very dangerous as, unlike direct contact, it is completely unexpected. For example, a person touching the metal frame of an electrical appliance which has defective insulation may be electrocuted through no fault of their own if the appliance is not protected.

How can we protect ourselves?

There are three possibilities :

- Preventing access to potentially dangerous metal components via class II protection.
- Good connection of all exposed conductive parts to an effective earth.
- A protective RCD according to the neutral earthing system.



A person is in danger of electrocution if the fault current raises the voltage of the accessible metal part above 50 V to earth.

Important note:

Under the Indian Electricity Rules [rules 61 (A), 71 (1) and 73 (1)], installation of an RCCB is mandatory in all installations of 5 KW and above, in all luminous tube signs and X-ray installations. The bureau of Indian standards recommends that RCCBs installed at construction sites, temporary installations, agriculture and horticulture premises, limit the residual current to 30 mA.

Residual current devices, selection and operation

The main function of a residual current device is to ensure that people are protected from any risk of electrocution. It can also ensure protection against risk of fire.

What is the nature of these risks ? What are the consequences ?

Here are the answers...

Risks of electrocution-

The dangerous effects of electricity depend on two factors-:

- the flowing time through the human body
- the current value

These two factors are independent and the importance of the risk varies in accordance with the level of each factor.

The dangerous current value through a human body depends on the touch voltage and touch resistance of the human body.

In practice, the current value is defined using a standard "safety" voltage of 50 V. This voltage takes into account the maximum current which can be withstood by a human being with a minimum internal electrical resistance in given conditions. It also takes into account the maximum permissible time for the current to pass through the body without dangerous physio-pathological effects.

50 V is considered as the safe limit of voltage for human body in dry condition.

How does an electrical current affect the human body?

When subject to a voltage, the human body reacts like any other receiver with a given internal resistance. An electrical current passes through the body with three serious risks :

- Locking of the muscles, or tetanisation : the muscles through which the current passes contract and remain contracted : if this includes the rib cage, breathing may be impeded.
- Action on the heart : the cardiac rhythm is completely disrupted (ventricular fibrillation).
- Thermal effects may cause varying levels of damage to body tissue, including severe burns in the case of very high currents.



Examples of electrocution by direct or indirect contact.

Technical data

Effect of current on human body

The standards define the following curves, which take into account the two parameters required to assess the risk :

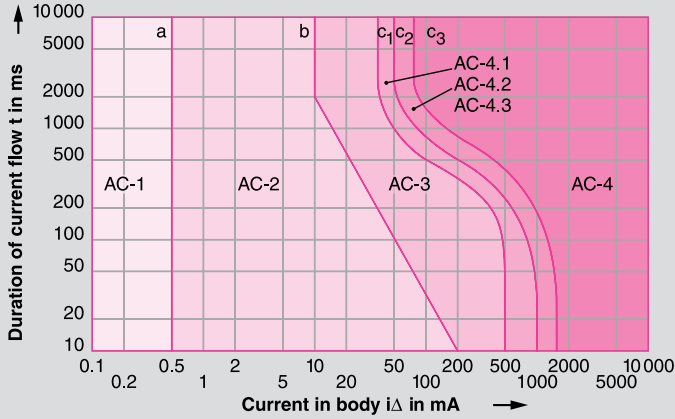

$i\Delta$: current flowing through body.
 t : time taken for current to pass through body.

These curves show the various zones of effect of an alternating current on people : they derive from IEC 60 479 and determine

4 main risk zones

Zone designation	Physiological effects
zone AC-1	Usually no reaction
zone AC-2	Usually no harmful physiological effects
zone AC-3	Usually no organic damage to be expected. Likelihood of cramp like muscular contractions and difficulty in breathing for durations of current-flow longer than 2 s. Reversible disturbances of formation and conduction of impulses in the heart, including atrial fibrillation and transient cardiac arrest without ventricular fibrillation increasing with current magnitude and time
zone AC-4	Increasing with magnitude and time, dangerous pathophysiological effects such as cardiac arrest, breathing arrest and serious burns may occur in addition to the effects of zone-3
zone AC-4.1	Probability of ventricular fibrillation increasing up to about 5% C1 - C2
zone AC-4.2	Probability of ventricular fibrillation up to about 50% C2 - C3
zone AC-4.3	Probability of ventricular fibrillation above 50%

* For durations of current flow below 10 ms, the limit for the body current at line b remains constant at a value of 200 mA.

A residual current device continuously measures the difference between the value of the input and the output currents. If the value is not equal to zero, this indicates a leak.

When this leak reaches the level at which the differential is set (its sensitivity), the device trips and breaks the circuit.

What are the operating principles of a residual current device?

What are the selection criteria for a residual current device? Here are the answers...

Operating principle of a residual current device

No fault present

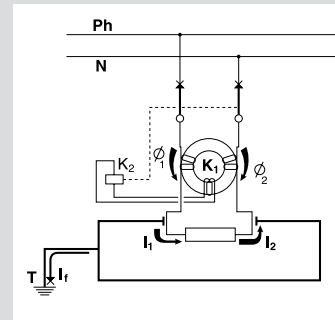

Therefore no current is induced in coil K₁, and coil K₂ is not excited. The contacts do not open. The equipment operates normally

$$I_r = 0, \text{ thus}$$

$$I_1 = I_2$$

$$\Phi_1 = \Phi_2$$

$$\Phi_1 - \Phi_2 = 0$$

Insulation fault

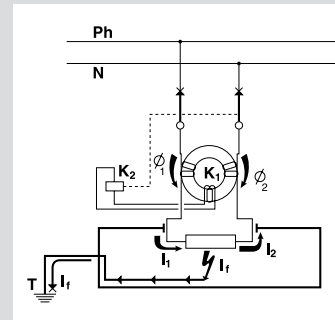

A current is thus induced in coil K₁...

$$I_r \neq 0$$

$$I_1 > I_2, \text{ thus}$$

$$\Phi_1 > \Phi_2, \text{ thus}$$

$$\Phi_1 - \Phi_2 \neq 0$$

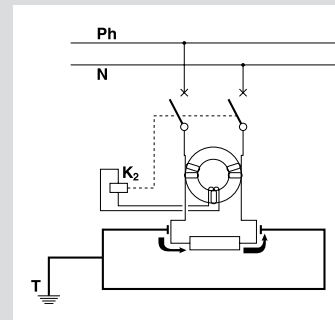

...coil K₂ is excited, the contacts open and the equipment is automatically switched OFF

Selecting a residual current device

First determine your requirement. This exists on two levels :

- 1 The need to protect against direct or indirect contacts.
- 2 The need to ensure protection against overloads and short-circuits.

If protection against indirect contact is required, use residual current devices with a sensitivity of :

- 30 mA,
- 100 mA,
- 300 mA,

The rating (40, 63 A, etc.) is selected according to the load.

If protection against direct contact is required, use residual current device with a sensitivity of 30 mA.

The sensitivity of a residual current device $I\Delta_n$ is the current level at which tripping is sure to occur. To do this, the standards concerning residual current devices stipulate that tripping must occur between $I\Delta_n / 2$ and $I\Delta_n$.

Technical data
Types of residual current device

There are 2 types of RCD : the AC type and the A type
Both types are produced in the "S" (discriminating) or normal versions.
They conform to Indian and International standards IS 12640, IEC 61008 and IEC 61009 as well as European standards EN 61008 and EN 61009.

• Type A 

Sensitive to residual alternating currents and residual currents with a DC component.

Use : special applications

- if it is possible that the fault currents are not purely sinusoidal (rectifier bridge, etc.)

• Type AC 

Sensitive to residual alternating currents

Use : standard applications

• Type S 

Delayed trip for discrimination with other residual current devices.

Use : for discrimination with a downstream device.

• Type Hpi 

• Enhanced immunity to unwanted tripping in environments with disturbances. eg. diesels, computers, printers, etc.

• Detects faults with DC components eg. thyristors, trio etc.

Residual current circuit-breaker with or without overload protection? Which do I choose?

Choose a residual current circuit-breaker (RCCB) if you do not need to protect against overload and short circuits (caution! an RCCB must be connected to some form of line protection device : either a circuit-breaker or a fuse).

Choose a residual current circuit-breaker with overload and short circuit protection (RCBO) if this type of protection is not available.

Residual current circuit-breakers without overload and short circuit protection (RCCB)

These provide two functions : fault current detection, measurement and cut-off : and isolation of an installation.

RCCBs are governed by standards IS 12640 (part 1), IEC 61008-1.

Residual current circuit-breakers with overload and short circuit protection (RCBO)

These provide three functions : fault current detection, measurement and cut-off : protection against overloads and short-circuits : and isolation of an installation.

Residual current circuit-breakers are governed by standards IS 12640 (part 2), IEC 61009-1.

The "test" function

A residual current device is a safety device, and it is therefore vital that it is regularly tested. This function is therefore required by the standard governing residual current protective devices, and ensures correct operation. All Lexic RCDs are equipped with this function.

Note : We offer Type AC, Type A-S and Type Hpi RCDs

Compatibility MCBs/add-on modules

Breaking capacity	Number of poles	Add-on module for 1.5 module/pole MCBs
16 kA	2P, 4P	In ≥ 80 A
25 kA	4P	In ≥ 32 A
	2P	In ≥ 40 A
	4P	In ≥ 12,5 A
50 kA	2P	In ≥ 32 A
	2P, 4P	All range

Operating principle

Temporarily electrical disturbances and other external events can cause unwanted tripping of different devices protecting electrical installation

STOP&GO verifies automatically the state of the installation, before resetting and launches a visual and close a contact in case of permanent fault detection (short-circuit or residual current)

After verifying the state of the installation, STOP&GO automatic resets the associated protection device in order to immediatly re-establish power supply and avoid unwanted consequences

STOP&GO does not protect the installation against lightning strikes
For an efficient protection against lightning, use voltage surge protectors

The Autotest version is specially suitable for installations equipped with residual current protection devices (RCD's and RCBOs)
STOP&GO periodically does an automatic test of the functioning of residual current protection devices. The manual test is no longer needed

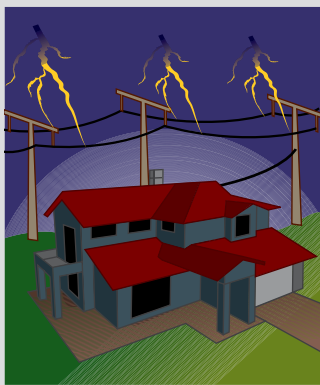

Installation without STOP&GO



Installation with STOP&GO

Mains fault due to temporarily electrical disturbances
Electrical devices are not powered anymore

STOP&GO automatic resets the associated protection device in order to immediatly re-establish power supply



Technical characteristics of auxiliaries

Max. connection cross-section: 2.5 mm²
Operating temperature: - 25 °C to + 70 °C

Shunt trips

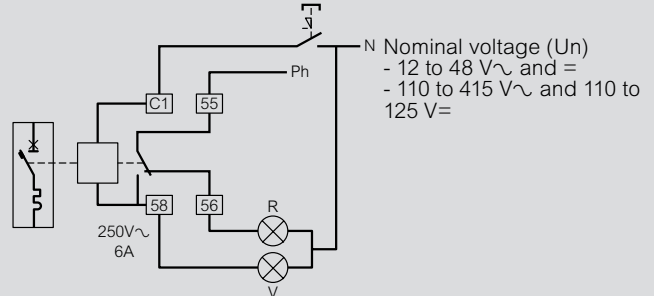

Equipped with a signalling contact which indicates tripping of the shunt trip and automatically breaks the coil.

Min. and max. voltage: 0.7 to 1.1 Un

Tripping time: less than 20 ms

Power consumption: at 1.1 x 48 V = 121 VA
at 1.1 x 415 V = 127 VA

Impedance: 12 to 48 V = 23 Ω
110 to 415 V = 1640 Ω

Consumption	Umin.	Umax.
12 to 48 V	522 mA	2610 mA
110 to 415 V	69 mA	259 mA

Undervoltage releases

Pull-in voltage ≥ 0.55 Un

Tripping time: 0 to 300 ms \pm 10% (adjustable)

Power consumption: 24 V \sim and = : 0.1 VA
48 V \sim and = : 0.2 VA
230 V \sim : 1 VA

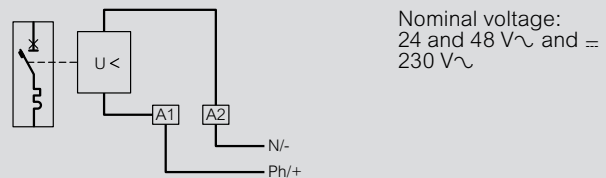

Stand-alone releases for N/C push-buttons

Min. and max. operating voltage: 196 to 250 V \sim

Power consumption: 1.4 VA

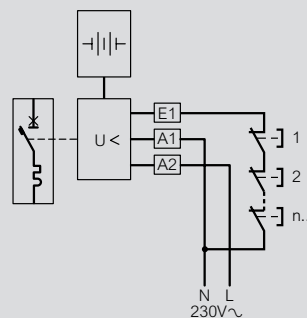

Signalling auxiliaries

Umin.: 24 V \sim / = and Imin.: 5 mA

Electric wiring diagram

Cat.No 4062 86

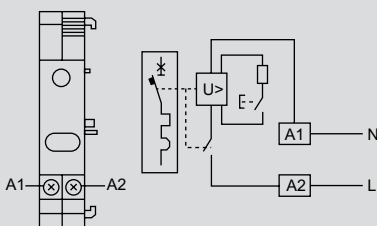

Tripping time:

Limit values of breaking time and non actuation time at a voltage

	255 V	275 V	300 V	350 V	400 V
Breaking time	No tripping	15 Sec	5 Sec	0.75 Sec	0.20 Sec
Non actuation time		3 Sec	1 Sec	0.25 Sec	0.07 Sec

Combinations with auxiliaries:

	CA / SD / ET / MT / DA	CM	
			4062 91/93/95
			4062 58/60/62/66
	4062 58/60/62/76/78/80/82/84/87	4062 58/60/62	4062 91
	4062 58/60/62/66/76/78/80/82/84/87	4062 66	
	4062 58/60/62	4062 58/60/62	4062 93/95
	4062 58/60/62/66	4062 66	

Protection of DC circuits

DX³ 6000 and DX³ 10000 MCBs (1P/2P/3P/4P - I_n ≤ 63 A) designed for use in 230/400 V~ supplies, can also be used in DC circuits. In this case, the following deratings and precautions must be taken into account:

1 - Protection against short-circuits

Max. magnetic tripping threshold: multiplied by 1.4

Example: For a C curve MCB for which the AC tripping threshold is between 5 and 10 I_n, the DC tripping threshold will be between 7 and 14 I_n

2 - Protection against overloads

The time/current thermal tripping curve is the same as for AC

3 - Operating voltage

Max. operating voltage: 80 V per pole (60 V for single-pole + N MCBs). For voltages higher than this value, several poles must be wired in series.

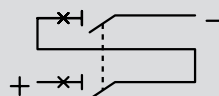

Example: for a 110 V voltage, use a 2-pole MCB and connect the 2 poles in series

4 - Breaking capacity

4000 A for a single pole MCB at max. voltage (80 V~ per pole)

For other voltages, the breaking capacities are as follows:

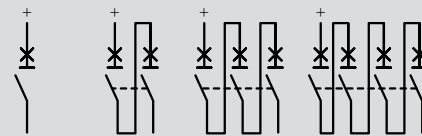

DX ³ 6000	voltage	single-pole	2P	3P	4P	
Acc. to IEC 60947.2	Icu	≤ 48 V	6 kA	6 kA		
		110 V		6 kA	6 kA	
		230 V				10 kA
	Ics ⁽¹⁾	≤ 48 V	100 %	100 %		
		110 V		100 %	100 %	
		230 V				100 %

DX ³ 10000	voltage	single-pole	2P	3P	4P	
Acc. to IEC 60947.2	Icu	≤ 48 V	10 kA	10 kA		
		110 V		10 kA	10 kA	
		230 V				15 kA
	Ics ⁽¹⁾	≤ 48 V	100 %	100 %		
		110 V		100 %	100 %	
		230 V				100 %

1: As a % of Icu

5 - Distribution of breaking poles

To choose the MCB and determine the pole distribution necessary for breaking on each of the polarities, it is necessary to know how the installation is earthed.

• Supply with one polarity earthed:

Place all the poles necessary for breaking on the other polarity. If isolation is required, an additional pole must be added on the earthed polarity.

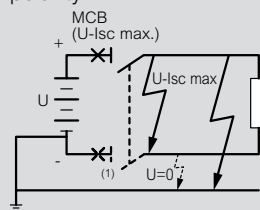

1: Only if isolation required

Protection of DC circuits

Protection of DC circuits

Example: circuit earthed via the negative polarity / $U = 110\text{ V}_{\text{DC}}$ / $I_{\text{sc}} = 10\text{ kA}$ / $I_n = 32\text{ A}$

Protect the positive polarity using an MCB capable of breaking 10 kA at 110 V (DX³ 10000 2P 32 A with 2 poles on the positive polarity)
For isolation, use a DX³ 10000 3P 32 A with 2 poles on the positive polarity and one pole on the negative polarity

DX ³ 10000	voltage	single-pole	2P	3P	4P
Acc. to	≤ 48 V	10 kA	10 kA		
IEC 60947.2 Icu	110 V	10 kA	10 kA	10 kA	
	230 V				15 kA

If isolation required

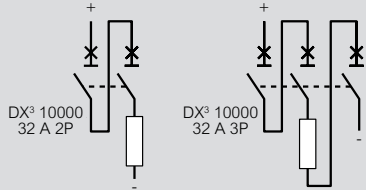

• Network earthed via a middle point:

Place on each polarity the number of poles necessary for max. I_{sc} breaking at half voltage

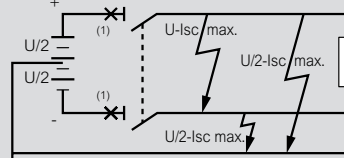

1: MCB ($U/2-I_{\text{sc}} \text{ max.}$)

Example: circuit earthed via a middle point / $U = 230\text{ V}_{\text{DC}}$ / $I_{\text{sc}} = 6\text{ kA}$ / $I_n = 10\text{ A}$

Protect each polarity using an MCB capable of breaking 6 kA at half voltage, i.e. 115 V

DX ³ 6000	voltage	single-pole	2P	3P	4P
Acc. to	≤ 48 V	6 kA	6 kA		
IEC 60947.2 Icu	110 V	6 kA	6 kA	6 kA	
	230 V				10 kA

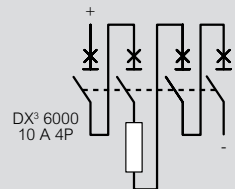

• Isolated earth supply:

Distribute the poles necessary for breaking over the 2 polarities to provide protection in the event of a double earth fault (particularly if there are a number of circuits in parallel)

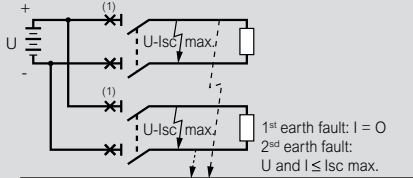

1: MCB ($U-I_{\text{sc}} \text{ max.}$)

Example: isolated earth circuit / $U = 48\text{ V}_{\text{DC}}$ / $I_{\text{sc}} = 4,5\text{ kA}$ / $I_n = 40\text{ A}$
Protect the installation with an MCB capable of breaking 4.5 kA at 48 V and protect each polarity

DX ³ 6000	voltage	single-pole	2P	3P	4P
Acc. to	≤ 48 V	6 kA	6 kA		
IEC 60947.2 Icu	110 V	6 kA	6 kA	6 kA	
	230 V				10 kA

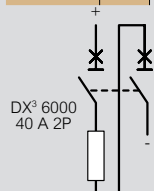

Programmable time switches

with analogue and digital dial

Diagrams

Cat.No 4126 31

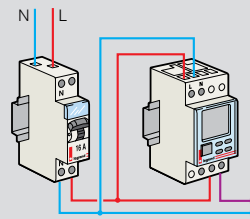

Cat.Nos 4126 54/34/29

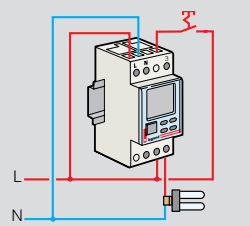

Cat.Nos 4126 57/41/30

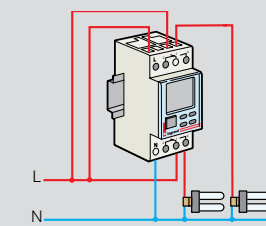

Cat.Nos 4127 90/94

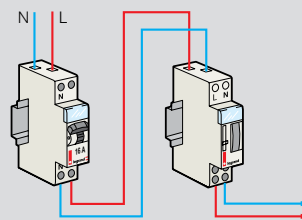

Cat.Nos 4128 12/13/14

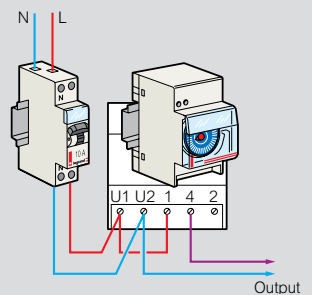

Output closing and breaking times are calculated based on the date, the actual time when the device was switched and on geographical coordinates of the actual location

AlphaRex³ digital time switches

Technical specifications

Type	AlphaRex ³ D21	AlphaRex ³ D22	AlphaRex ³ D21s	AlphaRex ³ D21 astro	AlphaRex ³ D22 astro	AlphaRex ³ DY21	AlphaRex ³ DY22
Nominal voltage 230 V 50/60 Hz	4126 31	4126 41	4126 34	4126 54	4126 57	4126 29	4126 30
Number of modules of 17.5 mm each	2	2	2	2	2	2	2
Number of channels	1	2	1	1	2	1	2
Switch output	1 changeover contact	2 changeover contacts	1 changeover contact	1 changeover contact	2 changeover contacts	1 changeover contact	2 changeover contacts
Zero-crossing switching	✓	✓	✓	✓	✓	✓	✓
Switching capacity							
• Ohmic 250 V \sim $\cos \varphi = 1$	16 A \sim	16 A \sim	16 A \sim	16 A \sim	16 A \sim	16 A \sim	16 A \sim
• Inductive 230 V \sim $\cos \varphi = 0.6$	10 A \sim	10 A \sim	10 A \sim	10 A \sim	10 A \sim	10 A \sim	10 A \sim
• Incandescent lamp load	2000 W	2000 W	2000 W	2000 W	2000 W	2000 W	2000 W
• Fluorescent lamp, series compensated	2000 VA	2000 VA	2000 VA	2000 VA	2000 VA	2000 VA	2000 VA
• Energy-saving lamp	1000 W	1000 W	1000 W	1000 W	1000 W	1000 W	1000 W
Programs ¹⁾	56	28 per channel	56	56	28 per channel	84	84 per channel
Control input with switch-off delay 0 s to 23 h 59 min 59 s			✓	✓		✓	
Cycle function (pulse time) min. 1 s, max. 1 h 59 min 59 s	✓	✓	✓	✓	✓	✓	✓
Clock precision (typical)	~ 0.1 s/day ²⁾						
Running reserve	5 years						
Shortest switching step	1 s						
Operating temperature	-20 to +55 °C						
Degree of protection	IP20						

¹⁾ A program consists of a switch-on time, a switch-off time as well as days or day blocks which are assigned as "switched-on" or "switched-off"

²⁾ Can be set to mains-synchronous operation

Connection diagram

AlphaRex³ D21

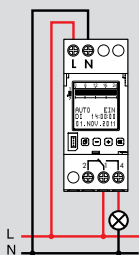

AlphaRex³ D22
AlphaRex³ D22 astro
AlphaRex³ DY22

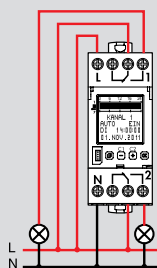

AlphaRex³ D21s
AlphaRex³ D21 astro
AlphaRex³ DY21

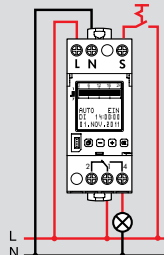

Functions

- Select menu, go back while in menu
Press > 1 sec. = operating display
- Confirm the selection or accept the parameter
- Select the menu item or set the parameter;
for 2-channel time switches, can be used to select the channel (channel 1 – channel 2)
-

Brief description of programming functions

Text guidance

Guides the user through programming and setup with plain text prompts. Each step can be read on the screen, and the function that is currently active flashes. An integrated display and button light makes operation easy even in poorly lit environments.

Set language

The language selection function can be accessed using the "MENU" button. The language is set to English by default. The following languages can be selected: German, English, French, Italian, Spanish, Dutch, Portuguese*, Swedish*, Norwegian*, Finnish*, Danish*, Polish*, Czech*, Russian*, Turkish*.

*) Excluding AstroRex DY64

Time, date, summer time (daylight saving time)

The time switch is preset at the factory to the current time and date. The time can be changed by selecting "MENU" + "SET".

Reset

Simultaneously pressing all buttons for more than 2 seconds deletes all data. Language, date/time, summer time (daylight saving time) and switch times must be set again.

Data key

If the supply voltage is switched on, the "KEY – READ – WRITE" menu item is automatically opened when a data key is inserted. "WRITE": Program data is written from the time switch to the key. Caution: Any data present on the key will be overwritten. "READ": Program data is written from the key to the time switch; any switching programs on the time switch are overwritten. Only one master switching program, which consists of multiple switching programs, can be saved on the time switch or on the key at a time. If the supply voltage is not connected, the "KEY – READ – WRITE" menu item is not automatically opened when a data key is inserted. The "KEY" function can still be selected from the menu even if the supply voltage is not connected.

PC programming

In addition to the easy, text-guided programming directly on the time switch, switching programs can also be created on a PC with the software program from Legrand and transferred to the time switch using a data key. A data transfer device (Cat.No : 4128 73) is required to transfer switching programs created on a PC to the data key. The device is connected to the PC using the USB plug. In addition to the data transfer device, we also offer a CD with the software and the necessary drivers. PC system requirements: USB port; Windows® XP, Windows® Vista, Windows® 7; approx. 40 MB of free memory.

Brief description of programming functions

Weekly programs

To create a weekly program, select "MENU", "PROGRAM", and then "CREATE" to easily enter programs which are repeated on a weekly basis. A weekly program consists of a switch-on/switch-off times and days which are assigned as "switched-on" or "switched-off". The following predefined blocks can be selected: "MONDAY – SUNDAY", "MONDAY – FRIDAY"¹⁾ or "SATURDAY – SUNDAY"¹⁾; the assigned days of the week are fixed. The switch-on/switch-off times must be entered. The user can also set custom day blocks. By selecting "CUSTOM", switch times can be freely assigned to any days of the week. This option also allows the user to set switch times at midnight.

¹⁾Excluding AlphaRex³ DY, AstroRex DY64

Yearly programs [AlphaRex³ DY21, AlphaRex³ DY22]

This menu item allows the user to enter (additional) yearly programs, which are only executed within a defined validity period. They can overlap with one another and with the weekly programs on the same channel based on an "OR" connective. The validity period is defined by entering the start date (at 00:00:00) and the end date (at 24:00:00). The start date must be entered before the end date. With the "EVERY YEAR" option, the additional switch times have the same validity period each year (Christmas, national holidays, birthdays, etc.) Select the "ONCE" option when additional switch times are needed within a validity period (e.g. during holidays), but the start/end dates of the holiday period change from year to year.

Special programs (priority program) [AlphaRex³ DY21, AlphaRex³ DY22]

Weekly and yearly programs on the same channel are not executed during the validity period of a special program. However, other special programs can be executed during the validity period. Different special programs can overlap with each other based on an "OR" connective. With the "EVERY YEAR" option, the additional switch times have the same validity period each year (Christmas, national holidays, birthdays, etc.). Select the "ONCE" option when additional switch times are needed within a validity period (e.g. during holidays), but the start/end dates of the holiday period change from year to year. Additional options include "MON TO SUN"/"CUSTOM": the respective channel only switches according to the special program; "PROG ON"/"PROG OFF": the respective channel is switched on/off during this time period.

Basic functions for "astro"

Location (astro) [AlphaRex³ D21 astro, AlphaRex³ D22 astro, AlphaRex³ DY21, AlphaRex³ DY22]

The sunrise/sunset times, which change daily, are calculated for the location programmed in the AlphaRex. The unit is delivered with the location set to "GERMANY – SOEST" by default. Enter the actual location for optimal operation. This can be done in two ways. Select "MENU", "SET" and "ASTRO" to access the two options "LOCATION" and "COORDINATES". "LOCATION": With this menu item, the user can select the country and city which is closest to the site of operation. "COORDINATES": Alternatively, the user can select this menu item to set the geographical coordinates of the location. The longitude and latitude values are entered in degrees and arcminutes²⁾ (precision can be set in expert mode). Information on coordinates and time zones can be found in the time zone map included with every time switch.

Offset

By selecting "MENU", "SET", "ASTRO" and "OFFSET", time differentials can be set for the calculated switch times. This can be done in two ways: time offset or angle offset.

In time offset, a time differential can be entered to shift the switch time by up to +/- 120 min relative to the sunrise/sunset times.

In angle offset²⁾, a value can be entered in degrees and arcminutes to shift the switch time by up to +/- 12° 00' relative to the sunrise/sunset times. The time differentials are set separately for sunrise and sunset using the menu items "SUNSET" (opens the screen for setting the sunset offset) and "SUNRISE" (opens the screen for setting the sunrise offset).

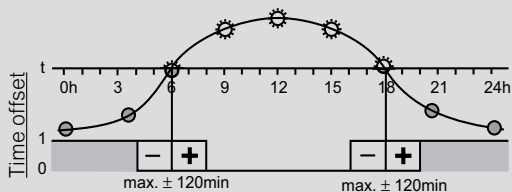

Example:

For a time differential of +30 min, the time switch switches 30 min. after sunrise and 30 min. after sunset.

For a time differential of -30 min, the time switch switches 30 min. before sunrise and 30 min. before sunset.

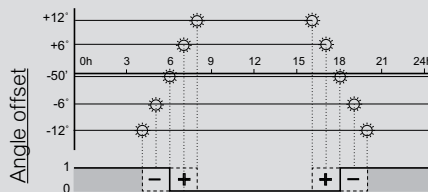

Note:

If the offset is set in degrees, the time switch always switches at points when the brightness is the same, despite the fact that the twilight duration changes over the course of the year. Sunrise and sunset correspond to -50' for the centre of the sun (the edge of the sun is visible on the horizon).

Offset correction function²⁾

Select "MENU", "SET", "ASTRO" and "CORRECTION" to set a time correction for the 6-month periods surrounding summer and winter. The time correction is set to 0 min. by default and can be set from 1 min. up to 30 min. The time correction for sunset is entered in the "SUNSET" menu item. The time correction for sunrise is set in the "SUNRISE" menu item. The correction function overlaps with the calculated astronomical switch times, including the offset settings.

Example:

Setting a time correction extends the daily switched-on time by up to 60 min. in the middle of the six winter months (switches off up to 30 min. later in the morning and switches on up to 30 min. earlier in the evening). In the middle of the six summer months, the time correction reduces the daily switched-on time by up to 60 min. (switches off up to 30 min. earlier in the morning and switches on up to 30 min. later in the evening). The time correction varies continuously between the two max. values during the rest of the year.

Basic settings using a PC and day key

All of the basic settings described above, with the exception of the current time and date, can be set up using the AlphaSoft software from Legrand and imported to the time switch using the data key.²⁾ Excluding AstroRex DY64

AlphaRex³ digital time switches

Additional functions

Relay function

The relay state can be changed by selecting "MENU" and "FUNCTIONS". The relay is preset to the "AUTO" function; the time switch switches at the programmed times. The following can also be selected: "ALWAYS ON", "ALWAYS OFF" and "EXTRA". If "EXTRA" is selected, the switching status specified by the program is inverted. The time switch resumes switching according to the programmed switch times after the next switch command.

Holiday program

In holiday program, the holiday period is set with a start and an end date. It can be activated with the "ACTIVE" program item and deactivated with "PASSIVE". If the holiday program is activated, the time switch does not carry out any programmed switch commands during this time period. Instead, it remains "ALWAYS OFF" or "ALWAYS ON" during the holiday period, as requested. When the holiday period has ended, the time switch resumes switching according to the programmed switch times.

1 h test

The "1 h TEST" function can be used for a switching simulation. If "1 h TEST" is activated, the switch outputs are switched for one hour. After the time has ended, the time switch resumes switching according to the programmed switch times.

PIN code

Input and programming can be locked using a four-digit "PIN CODE". The time switch can be unlocked using the "PIN CODE". The time switch can also be unlocked using the "RESET" function, which also deletes all settings and programs.

Operating hours counter

This function displays the time for which the relay has been switched on and the date of the last reset. Counting range: 65,535 h.

Contrast adjustment

This function allows the user to adjust the display contrast.

Expert mode*

Expert mode is activated by selecting "OPTIONS" and "EXPERT". After expert mode is activated, the following additional functions can be used: control input "extra"¹⁾, control input "out"¹⁾, cycle function, channel-switching function (2-channel time switches), mains-synchronous operation, offset correction function²⁾, geographical coordinates in degrees and arcminutes²⁾.

¹⁾ AlphaRex³ D21s, AlphaRex³ D21 astro, AlphaRex³ DY21 ²⁾ AlphaRex³ astro, AlphaRex³ DY

Control input with switch-off delay

Adjustable switch-off delay via control input. The control input enables an additional switching of the relay, parallel to the switching program. The switch-off delay can be set from 0 s to 23 h 59 min 59 s. The switch-off delay begins as soon as the voltage is removed from the control input.

Control input "extra"*

Override of switching state via control input. If the "EXTRA" function is activated, the switching state specified by the program is inverted. The time switch resumes switching according to the programmed switch times after the next switch command. The "EXTRA" function is ended prematurely if the button is pressed again or if a pulse is received at the control input.

Control input "off"*

Switch off via control input. Activating the "OFF" function causes the time switch to be switched off via the control input. The "OFF" function is ended if the button is pressed again or if a pulse is received at the control input. The time switch resumes switching on/off according to the programmed switch times.

Pulse function

Programmable with precision to the second.

Cycle function

Function for cyclical switching. With this function, the time switch is switched on once within a defined time period and for a defined duration. The cycle time can be set between 2 s and 2 h. The switch-on time can be set between 1 s and 1 h 59 min 59 s.

	Min.	Max.
Cycle	2 s	2 h
Switch-on time	1 s	1 h 59 min 59 s

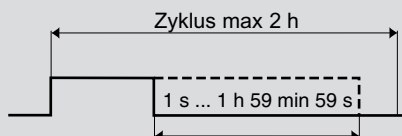

Random function

If the random function is activated, set switch times are randomly shifted within a range of +/- 15 minutes.

Channel-switching function*

With 2-channel time switches, this function can be activated so that the time switch regularly switches between the outputs assigned to the channels, in order to protect connected devices (for example lights/lamps) or so that two devices can be used simultaneously. The channel-switching function is activated by selecting "MENU", "OPTIONS" and "CHANNEL 1<>2". The time switch switches between the outputs according to whether the menu item "DAILY" (once per day at 12:00 p.m.) or "WEEKLY" (once per week on Sunday at 12:00 p.m.) is selected.

Mains-synchronous operation

Mains-synchronised clock precision. By activating the "SYNC" function and then "ACTIVE", the quartz-controlled time switch becomes a synchronous time switch.

*) Excluding AstroRex DY64

Technical specifications

Type	MicroRex T31	MicroRex QT31	MicroRex W31	MicroRex QT11	MicroRex QW11
Number of modules of 17.5 mm each	3	1			
Number of channels	1	1	1	1	1
Drive type	synchronous	quartz	synchronous	quartz	quartz
Switching dial	24 h	24 h	7 days	24 h	7 days
Running reserve	none	100 h	none	100 h	100 h
Switching increment	15 min	15 min	2 h	15 min	2 h
Shortest switching step	30 min	30 min	4 h	15 min	2 h
Switching step	+/- 5 min	+/- 5 min	+/- 30 min	+/- 5 min	+/- 30 min
Clock precision	mains	2.5 s/day	mains	2.5 s/day	2.5 s/day
Switching capacity					
• Ohmic 230 V~ cos φ = 1	16 A~				
• Incandescent lamp 230 V~	4 A~				
• Inductive 230 V~ cos φ = 0.6	12 A~				
Switch output	1 changeover contact	1 changeover contact	1 changeover contact	1 normally open contact	1 normally open contact
Operating temperature	-10 to +55 °C				
Degree of protection	IP20				

Connection diagram

MicroRex – 3 modules

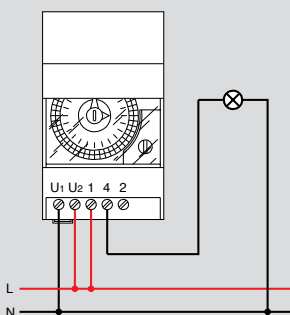

MicroRex – 1 module

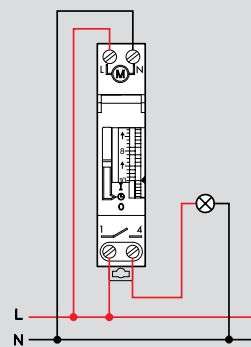

Wall bracket – 3 modules

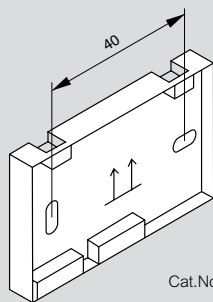

Cat.No 4128 59

3-module MicroRex units can be surface mounted using the wall bracket. A terminal cover is included with delivery.

Standard light sensitive switch (Cat.No 4126 23)

Switch "ON" and "OFF" defined by a light level threshold

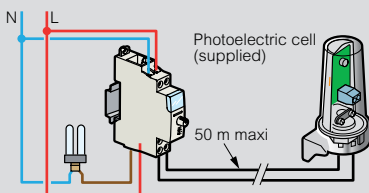

CX³ Changeover switches

Power dissipation per role : 1.5 w
 Overvoltage category : 4 kV~
 Dielectric withstand : 2 kV~
 Degree of pollution : 2

CX³ Push-buttons and control switches

Electrical endurance : 30 000 cycles AC12
 (cos φ = 0.9) IEC 60947-5-1
 Electrical endurance under fluorescent loads : 30 000 cycles according to IEC 60669-1

CX³ LED indicators

Equipped with non replaceable LED lamps
 LED life : 100 000 h.
 LED consumption :
 - 0.17 W under 230 V~
 - 0.11 W under 24 V~

Power contactors CX³

Technical characteristics

- Rated impulse withstand voltage (Uimp): 4 kV
- Mechanical endurance (no. of operating cycles): 10⁶ cycles
- Operating temperatures: - 25 °C to + 40 °C
- Storage temperatures: - 40 °C to + 70 °C

Contactor protection against short circuits according to standard EN 61095, conditional short-circuit current:

- I_q = 6 kA for 16 to 25 A contactors

- I_q = 3 kA for 40 to 63 A contactors

Circuit breaker or gG fuse rated:

- ≤ 16 A for 16 A rating • ≤ 40 A for 40 A rating
- ≤ 25 A for 25 A rating • ≤ 63 A for 63 A rating

Consumption of a contactor control coil

16 A and 25 A power contactors					
Coil voltage	24 V~		230 V~ low noise	230 V~	
Current	16 A and 25 A	25 A	25 A	16 A and 25 A	16 A and 25 A
Type of contact	NC + NO 2 NO	4 NO	2 NO	NC + NO 2 NO 2 NC	2 NC + 2 NO 4 NO 4 NC
Dimensions	1 mod.	2 mod.	1 mod.	1 mod.	2 mod.
Holding current	200 mA	300 mA	12 mA	20 mA	20 mA
Inrush current	970 mA	2500 mA	60 mA	90 mA	200 mA

40 A and 63 A power contactors				
Coil voltage	24 V~		230 V~	
Current	40 A and 63 A	40 A and 63 A	40 A and 63 A	40 A and 63 A
Type of contact	2 NO	4 NO	2 NO 2 NC	3 NO 4 NO 4 NC
Dimensions	2 mod.	3 mod.	2 mod.	3 mod.
Holding current	250 mA	270 mA	15 mA	30 mA
Inrush current	1750 mA	1500 mA	150 mA	200 mA

Recommendations

Insert a spacing module (Cat.No 4063 07 p. 40):

- every two contactors when the ambient temperature is below 40 °C

- every contactor when the ambient temperature is between 40 and 60 °C

Contactor rating	40 °C	50 °C	60 °C
le = 16 A	16 A	14 A	12 A
le = 25 A	25 A	22 A	20 A
le = 40 A	40 A	36 A	32 A
le = 63 A	63 A	57 A	50 A

Max. connection cross-section in mm²

Conductor type	Ratings ≤ 25 A	Ratings 40 & 63 A
Rigid	6 ² or 2 x 2.5 ²	25 ² or 2 x 10 ²
Flexible	6 ² or 2 x 2.5 ²	25 ² or 2 x 10 ²
Flexible with single end cap	6 ²	16 ²
Flexible with double end cap	2 x 4 ²	2 x 16 ²

Contactor selection charts

Incandescent lamps

Tungsten and halogen filaments 230 V~								
Nominal wattage	40 W	60 W	75 W	100 W	150 W	200 W	500 W	1000 W
16 A	45	30	24	19	13	10	4	2
25 A	60	48	38	30	20	15	6	3
40 A	96	77	61	48	32	24	10	5
63 A	154	123	97	77	51	38	15	8

ELV halogen bulbs with ferromagnetic ballast							ELV halogen bulbs with electronic ballast						
Nominal wattage	20 W	35 W	50 W	75 W	100 W	150 W	20 W	35 W	50 W	75 W	100 W	150 W	
16 A	32	20	15	12	9	6	60	40	28	18	14	9	
25 A	52	30	24	16	12	8	80	50	40	26	20	13	
40 A	68	39	31	21	16	10	112	70	56	36	28	18	
63 A	88	51	41	27	20	14	157	98	78	51	39	25	

Contactor selection charts (continued)

Fluorescent tubes with ferromagnetic ballast

Nominal wattage	Single parallel compensated fluorescent					Double series compensated fluorescent				
	18 W	20 W	36 W	58 W	115 W	2 x 20 W	2 x 36 W	2 x 40 W	2 x 58 W	2 x 140 W
16 A	24	24	16	11	5	30	24	22	15	6
25 A	33	30	25	17	9	45	38	35	24	10
40 A	43	39	33	22	12	68	57	53	36	15
63 A	56	51	42	29	15	101	86	79	54	23

Nominal wattage	Quadruple series compensated fluorescent				Compact fluorescent with built-in starter			
	4 x 18 W				7 W	10 W	18 W	26 W
16 A	16				50	40	28	19
25 A	24				60	50	42	28
40 A	36				78	65	55	36
63 A	54				101	85	71	47

Fluorescent tubes with electronic ballast

Nominal wattage	Single fluorescent				Double fluorescent		
	18 W	30 W	36 W	58 W	2 x 18 W	2 x 36 W	2 x 58 W
16 A	72	42	36	22	36	20	12
25 A	110	68	58	36	56	30	19
40 A	165	102	87	54	84	45	29
63 A	248	153	131	81	126	68	43

Nominal wattage	Triple fluorescent (series compensated)			Quadruple fluorescent (series compensated)	
	3 x 14 W	3 x 18 W	4 x 14 W	4 x 18 W	
16 A	34	26	26	20	
25 A	46	38	37	28	
40 A	62	51	52	39	
63 A	84	69	73	55	

Compact fluorescent with built-in electronic power supply					
Nominal wattage	7 W	11 W	15 W	20 W	23 W
16 A	120	80	64	50	43
25 A	200	125	90	70	60
40 A	280	175	126	98	84
63 A	392	245	176	137	118

Discharge lamps with compensation

Nominal wattage	Metal halogenide						Low pressure sodium vapour					
	35 W	70 W	100 W	150 W	250 W	400 W	18 W	35 W	55 W	90 W	135 W	180 W
16 A	10	6	5	3	2	1	12	6	5	3	2	2
25 A	15	9	7	5	3	2	20	10	7	5	3	3
40 A	23	14	11	8	5	3	30	15	11	8	5	5
63 A	34	20	16	11	7	5	45	23	16	11	7	7

Nominal wattage	High pressure sodium vapour					High pressure mercury vapour				
	70 W	150 W	250 W	400 W	1000 W	50 W	80 W	125 W	250 W	400 W
16 A	8	7	5	3	1	11	8	6	3	2
25 A	10	9	6	4	2	15	10	8	4	3
40 A	15	14	9	6	3	21	14	11	6	4
63 A	23	20	14	9	5	29	20	16	8	6

Nominal wattage	High pressure mixed			
	100 W	160 W	250 W	400 W
16 A	9	6	4	2
25 A	11	7	5	3
40 A	14	9	7	4
63 A	19	12	8	5

EMDX³ electrical energy meters

└ rail mounting

Technical characteristics

Single-phase meters Cat.Nos 0046 70/77

LCD display: 7 digits
 Resolution: 0.1 kWh
 Maximum indication: 99999.9 kWh
 Metrological LED: 1 Wh/pulse (Cat.No 0046 70 : 0.5 Wh/pulse)
 Accuracy (EN 62053-21): class 1
 Reference voltage Un: 230 V-240 V
 Reference frequency: 50-60 Hz
 Pulse output: 1 pulse/10 Wh
 (Cat.No 0046 70: 2 pulse/Wh)

Three-phase meters Cat.Nos 0046 80/84

LCD display: 8 digits
 Resolution: 0.01 kWh⁽¹⁾
 Maximum indication: 99999.99 kWh⁽¹⁾
 Metrological LED: 0.1 Wh/pulse or 1 Wh/pulse
 Active energy accuracy (EN 62053-21): class 1
 Reactive energy accuracy (EN 62053-23): class 2
 Reference voltage Un:
 - Single-phase: 230-240 V
 - Three-phase: 230(400)-240(415) V
 Operating limit range (EN 62053-21, EN 62053-23):
 - Single-phase: 110 to 254 V
 - Three-phase: 110(190) to 254(440) V
 Pulse output: 1 pulse/10 Wh

Cat.Nos	0046 70	0046 77	0046 80	0046 84	
Number of modules	1	2	4	4	
Connection	Direct	●	●	●	
	Via a current transformer			●	
	Single-phase	●	●	●	
	Three-phase			●	
Max. current	32 A	63 A	63 A	5 A (CT)	
Metering and measurement	Total active energy	●	●	●	
	Total reactive energy			●	
	Partial active energy (reset)		●	●	
	Partial reactive energy (reset)			●	
	Active power		●	●	
	Reactive power			●	
	Apparent power			●	
	Current		●	●	
	Voltage		●	●	
	Frequency		●	●	
	Power factor		●	●	
	Time-of-use		●		
	Average active power			●	
	Max. average active power value			●	
Communication	Pulse output	●		●	
	RS 485 interface		●	●	
MID compliant					
Operating conditions	Reference temperature	23 °C ± 2 °C			
	Operating temperature	-20 to +55 °C	-10 to +45 °C	-5 to +55 °C	
	Storage temperature	-40 to +70 °C	-25 to +70 °C	-25 to +70 °C	
	Consumption	≤ 8 VA		≤ 4 VA per phase	≤ 1 VA per phase
	Heat dissipation	≤ 6.5 W		≤ 6 W	≤ 4 W

Interfacing with IP communication network

RS 485 electricity meters

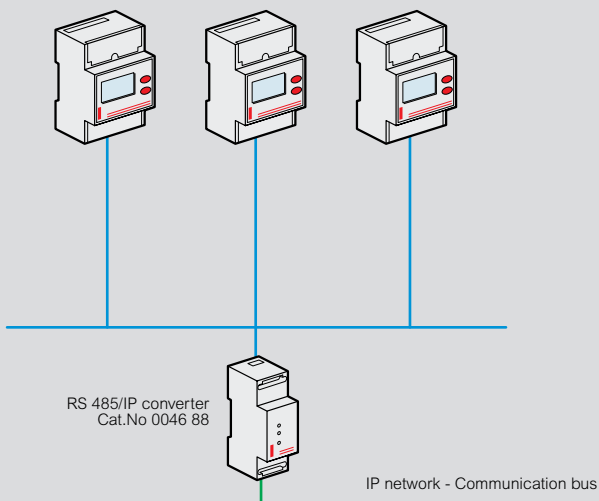

1: For direct connection meters
 If connected via transformers, the resolution and maximum indication depend on the transformation ratios of these transformers

EMDX³ multi-function measuring units

Technical characteristics

Cat.Nos		0046 76	
Connection	Current measurement terminals	4 mm ²	
	Other terminals	2.5 mm ²	
Protection index	Front cover	IP 51	
	Casing	IP 20	
Weight	205/215 g		
Display	Backlit LCD		
Measurements	3P+N, 3P, 2P, 1P+N		
	Direct	Phase/phase	50 to 520 V~
Voltage measurement	From a PT	Phase/neutral	28 to 300 V~
		Primary	-
	Secondary	-	
	Permanent overload between phases	760 V~	
Current measurement	Update period	1 s	
	From a CT	Primary	5 to 9999 A
		Secondary	5 A
	Minimum measurement	5 mA	
	Input consumption	< 0.6 VA	
	Display	0 to 9999 A	
Permanent overload	6 A		
Power measurement	Intermittent overload	60 A/1 s - 120 A/0.5 s	
	Update period	1 s	
	Max. CT x PT ratio	-	
	Total	0 to 9999 kW/kvar/kVA	
Frequency measurement	Update period	1 s	
	Measurement range	45.0 to 65.0 Hz	
Auxiliary power supply	50/60 Hz	200 to 277 V~ ±15%	
	DC	-	
Operating temperature	Consumption	< 5 VA	
	Storage temperature	-10 °C to +55 °C	

Connection solutions

Unbalanced three-phase network (3 or 4-wire)

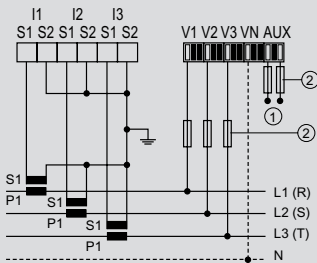

Balanced three-phase network (3 or 4-wire)

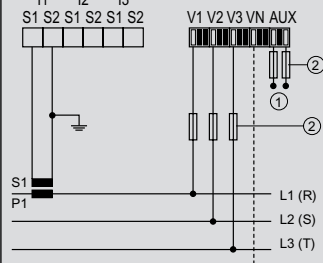

(3-wire)

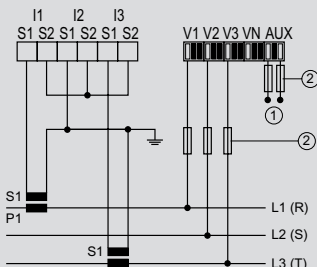

Single-phase network (2-wire)

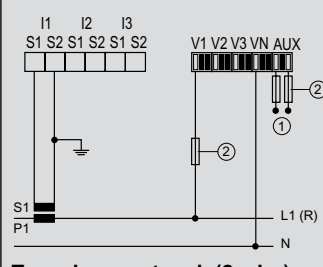

Two-phase network (2-wire)

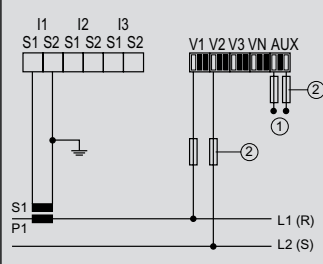

① Auxiliary power supply: 110 ... 400 VAC/120 ... 350 VDC
 ② Fuse: 0.5 A gG/BS 88 2 A gG/0.5 A class CC

Wiring example of communication network

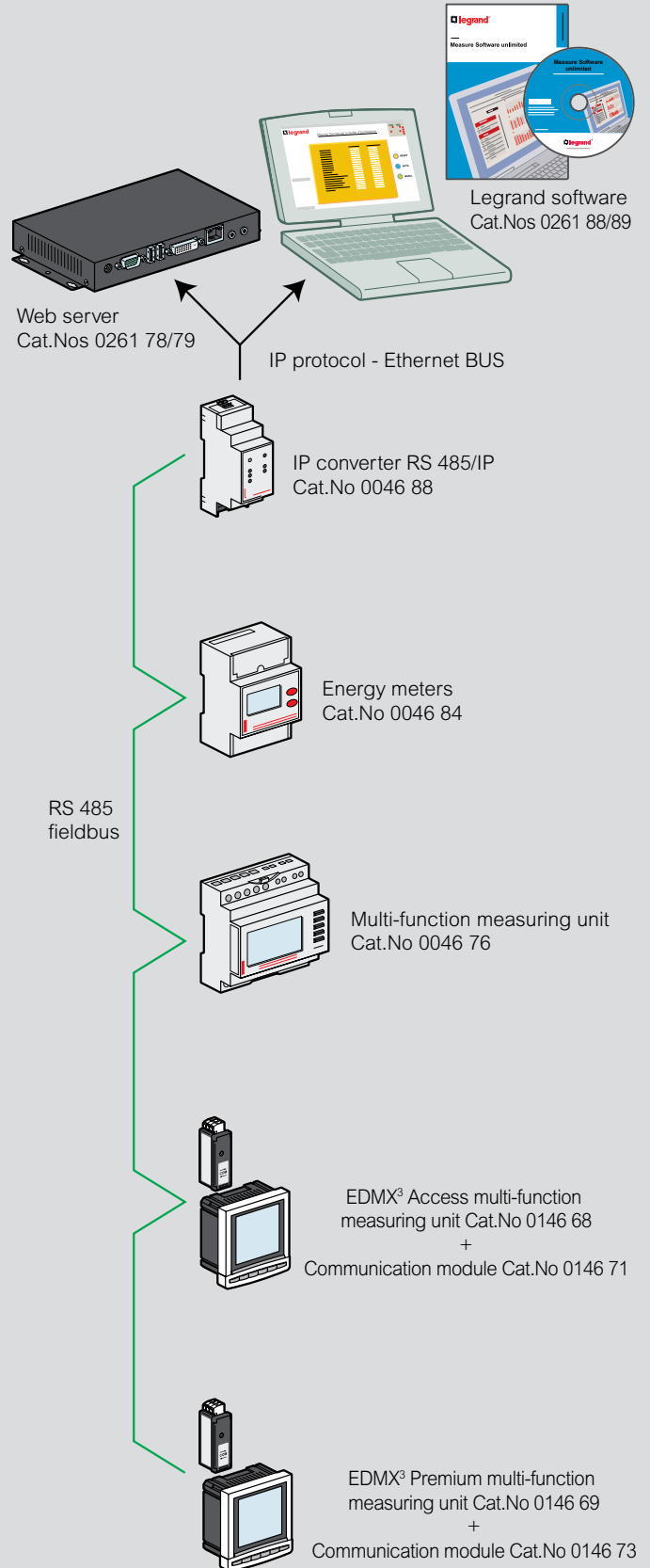

Surge Protective Devices (SPDs)

protection against transient overvoltages

Protection against lightning and overvoltages

Protection against the effects of lightning is essentially based on:

- Protecting buildings using a lightning protection system (LPS or lightning conductors) to catch lightning strikes and to drive the lightning current to earth.
- The use of surge protective devices (SPDs) to protect equipment.
- The design of the earthing system (passive protection of the installation).

Throughout the world, there are millions of lightning strikes each day in the summer (up to 1000 lightning strikes/second). Lightning is responsible for 25% to 40% of all damage to equipment. When added to industrial overvoltages (switching overvoltages due to the operation of internal equipment), they account for more than 60% of all electrical damages, which can be prevented by installing SPDs (according to the country and type of installation - source: insurance companies).

In some countries, and depending on the end use of the building, national regulations may always stipulate the installation of SPDs (for example, Germany, Austria, Norway, etc.). If there are no specific national regulations, SPDs are usually specified by national installation standards (based on HD/IEC 60364 international installation standards) and EN/IEC 62305 standards.

External lightning protection system (LPS) or lightning conductors: protection of buildings (EN/IEC 62305)

An external lightning protection system (LPS) protects buildings against direct lightning strikes. It is generally based on the use of lightning conductors (single rod, with sparkover device, meshed cage, etc.) and/or the metallic structure of the building.

If there is an LPS or if a lightning risk assessment has been carried out in accordance with EN/IEC 62305 standards, SPDs are generally required in the main distribution board (T1 SPDs) and distribution boards (T2 SPDs).

Determination of the SPDs in the main distribution board in accordance with EN/IEC 62305 and TS/IEC 61643-12 (if there is insufficient information available):

LPL: Lightning protection level	Total lightning current of the LPS	Min. value of Imp current of the SPD (T1)	Usage practices
I	200 kA	25 kA/pole (IT: 35 kA min.)	Power installations
II	150 kA	18.5 kA/pole	Rarely used
III/IV	100 kA	12.5 kA/pole	Small installations

1: LPL (Lightning Protection Level)

Surge protective device (SPD) (internal protection)

The SPD

- Protects sensitive devices against overvoltages caused by lightning and industrial overvoltages, by limiting the overvoltages to values that are tolerated by the equipment
- Limits the possible harmful consequences in terms of the safety of people (medical equipment installed in the home, security systems, environmental systems, etc.)
- Maximises the continuity of operation of equipment and limits production losses

SPDs and standards

Standards EN/IEC 61643-11

Type of SPD		Test waves
EN 61643-11	IEC 61643-11	
Type 1 (T1)	Class I (T1)	I_{imp} : 10/350 μ s (discharge current) I_n : 8/20 μ s (nominal current, 15 shocks)
Type 2 (T2)	Class II (T2)	I_{max} : 8/20 μ s (discharge current) I_n : 8/20 μ s (nominal current, 15 shocks)

T1+T2 SPDs: tested in accordance with both methods.

T1 or T1+T2 SPDs are being increasingly used at the supply origin of installations, even when there is no lightning conductor, as they enable higher energies to be discharged and increase the service life the SPD.

HD/IEC 60364 electrical installation standards

According to articles 443 and 534 of HD/IEC 60364 standards and the TS/IEC 61643-12 guides, the use of SPDs in new or renovated buildings is compulsory at the supply origin of the installation in the following cases:

- Buildings with lightning conductors (T1 SPDs, $I_{imp} \geq 12.5$ kA)
- Buildings with totally or partially overhead power supplies in AQ2 geographical areas (article 443.3.2.1 - AQ2: $N_k > 25$, see map below) and based on a risk assessment taking into account the type of power supply to the building (article 443.3.2.2)

According to article 443.3.2.2, SPDs (Type 2) are also required in the following cases:

- Commercial/industrial buildings, public buildings and services, religious buildings, schools and large residential complexes, etc.
- Hospitals and buildings containing medical equipment and/or security systems for people and property (fire alarm, technical alarms, etc.)

Important: it is advisable to install an SPD when the safety of people may depend on the continuity of service of equipment (even if this is not required by national standards). Although not compulsory according to the installation standards, an SPD should always be installed to protect the communication equipment when there is an SPD on the low voltage power network.

These rules should change in 2015. Please consult Legrand.

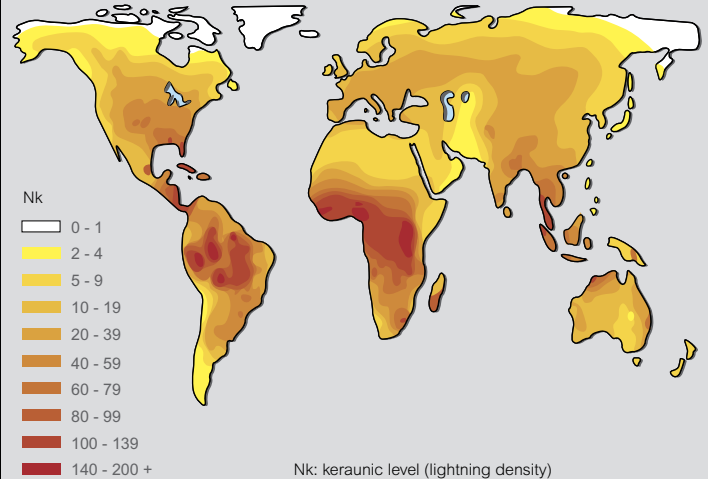

Protection of distribution boards and sensitive equipment (cascaded protection)

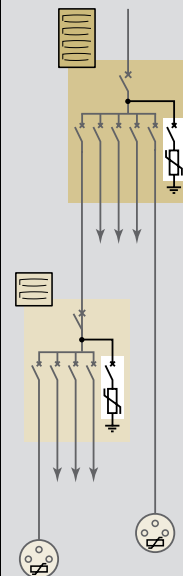

Effective protection against overvoltages cannot generally be assured with a single SPD if its protection level (U_p) is greater than 1.2 kV (EN/IEC 62305 and TS/IEC 61643-12).

When there are overvoltages, an SPD protects equipment by limiting these overvoltages to values that can be tolerated by the equipment. Thus, depending on its discharge capacity (discharge current I_n , I_{max} , etc.) and its protection level (U_p), an SPD will limit these overvoltages to varying values depending on the energy levels involved. The overvoltage values that may be transmitted downstream of the SPD may double over distances of more than 10 m due to resonances associated with the type of electrical installation and the type of equipment. Overvoltages greater than 2.5 kV may then occur and damage equipment if the residual energy is high enough (2.5 kV being the insulation level of most electrical and electronic equipment, or typically 1.5 kV for electrical domestic appliances).

SPDs should be installed in the distribution boards supplying equipment that is sensitive or critical for the activity being carried out (and/or near to equipment with proximity SPDs).

Surge Protective Devices (SPDs)

technical characteristics

Modular SPDs

230/400 V~ power network (50/60 Hz) - Degree of protection IP 20

Operating temperature: -10 to +40 °C/Storage temperature: -20 to +70 °C

1P+N (3P+N) SPDs: L-N and N-PE protection, also called 1+1 (3+1 resp.) or CT2 type protection depending on installation standards.

Cat.Nos	Type	Poles	Earthing system	Max. voltage (Uc)	Protection mode	Nominal current In/pole (8/20)	Max. discharge current			Protection level		Max. short-circuit current Isc (IscCR)	Protective device to be used ¹	FS auxiliary (remote status monitoring)		
							I _{max} /pole (8/20)	I _{imp} /pole (10/350)	I _{total} (10/350)	Up (L-N/L-PE/N-PE)	Up at 5 kA					
0030 00 4122 80	T1/50 kA T1/35 kA	1P	TT, TNC, TNS, IT	440 V~	CT1	50 kA 35 kA		50 kA 35 kA	50 kA 35 kA	2.5 kV		50 kA	DPX ³ 160 80 A	no yes		
4122 81	T1/25 kA	1P+N	TT, TNS	350 V~	CT2	25/50 kA		25/50 kA	50 kA	1.5/2.5/1.5 kV				yes		
4122 82	T1/25 kA	3P	TNC	350 V~	CT1	25 kA		25 kA	75 kA	1.5 kV				yes		
4122 83	T1/25 kA	3P+N	TT, TNS	350 V~	CT2	25/100 kA		25/100 kA	100 kA	1.5/2.5/1.5 kV				yes		
4122 70	T1+T2/12.5 kA	1P	TT, TNC, TNS	320 V~	CT1	25 kA	60 kA	12.5 kA	12.5 kA	1.5 kV at 12.5 kA 1.9 kV at 25 kA	1 kV	50 kA	DX ³ 63 A C curve	no		
4122 71	T1+T2/12.5 kA	2P	TT, TNS	320 V~	CT1	25 kA	60 kA	12.5 kA	25 kA							no
4122 72	T1+T2/12.5 kA	3P	TNC	320 V~	CT1	25 kA	60 kA	12.5 kA	37.5 kA							yes
4122 73	T1+T2/12.5 kA	4P	TT, TNS	320 V~	CT1	25 kA	60 kA	12.5 kA	50 kA					no		
4122 76	T1+T2/12.5 kA	1P+N	TT, TNS	320 V~	CT2	25/25 kA	60 kA	12.5/25 kA	25 kA	1.5/1.6/1.5 kV at 12.5 kA 1.9/2.1/1.5 kV at 25 kA	1 kV		yes			
4122 77	T1+T2/12.5 kA	3P+N	TT, TNS	320 V~	CT2	25/50 kA	60 kA	12.5/50 kA	50 kA					yes		
4122 50	T1+T2/8 kA	1P	TT, TNC, TNS	320 V~	CT1	20 kA	50 kA	8 kA	8 kA	1.2 kV at 8 kA 1.7 kV at 20 kA	1 kV	50 kA	DX ³ 40 A C curve	no		
4122 51	T1+T2/8 kA	2P	TT, TNS	320 V~	CT1	20 kA	50 kA	8 kA	16 kA							no
4122 52	T1+T2/8 kA	3P	TNC	320 V~	CT1	20 kA	50 kA	8 kA	25 kA							no
4122 53	T1+T2/8 kA	4P	TT, TNS	320 V~	CT1	20 kA	50 kA	8 kA	32 kA					no		
4122 56	T1+T2/8 kA	1P+N	TT, TNS	320 V~	CT2	20 kA	50 kA	8 kA	16 kA	1.2/1.5/1.5 kV at 8 kA 1.7/2/1.5 kV at 20 kA	1 kV		no			
4122 57	T1+T2/8 kA	3P+N	TT, TNS	320 V~	CT2	20 kA	50 kA	8 kA	25 kA					no		
4122 40	T2/40 kA	1P	TT, TNC, TNS	320 V~	CT1	20 kA	40 kA			1.5 kV at 15 kA 1.7 kV at 20 kA	1 kV	50 kA	DX ³ 25 A C curve	no		
4122 41	T2/40 kA	2P	TT, TNS	320 V~	CT1	20 kA	40 kA									no
4122 42	T2/40 kA	3P	TNC	320 V~	CT1	20 kA	40 kA									yes
4122 43	T2/40 kA	4P	TT, TNS	320 V~	CT1	20 kA	40 kA									no
4122 46 4122 66	T2/40 kA	1P+N	TT, TNS	320 V~	CT2	20 kA	40 kA			1.5/1.6/1.4 kV at 15 kA 1.7/2/1.4 kV at 20 kA	1 kV	50 kA 25 kA	DX ³ 25 A C curve	no yes		
4122 47 4122 67	T2/40 kA	3P+N	TT, TNS	320 V~	CT2	20 kA	40 kA									no yes
4122 30	T2/40 kA	1P	TT, TNC, TNS, IT	440 V~	CT1	20 kA	40 kA			1.8 kV at 15 kA 2.1 kV at 20 kA	1.3 kV			50 kA	DX ³ 25 A C curve	no
4122 32	T2/40 kA	3P	TNC, IT	440 V~	CT1	20 kA	40 kA									
4122 33	T2/40 kA	4P	TT, TNS, IT	440 V~	CT1	20 kA	40 kA									yes
4122 20	T2/20 kA	1P	TT, TNS	320 V~	CT1	10 kA	20 kA			1.2 kV at 5 kA 1.4 kV at 10 kA	1.2 kV	25 kA	DX ³ 20 A C curve	no		
4122 21	T2/20 kA	2P	TT, TNS	320 V~	CT1	10 kA	20 kA									no
4122 23	T2/20 kA	4P	TT, TNS	320 V~	CT1	10 kA	20 kA									no
4122 26 4122 62	T2/20 kA	1P+N	TT, TNS	320 V~	CT2	10/20 kA	20 kA			1.2/1.4/1.4 kV at 5 kA 1.4/1.4/1.4 kV at 10 kA	1.2 kV				no yes	
4122 27 4122 63	T2/20 kA	3P+N	TT, TNS	320 V~	CT2	10/20 kA	20 kA							no yes		
0039 51 0039 71	T2+T3/12 kA	1P+N	TT, TNS	275 V~	CT2	10/10 kA	12 kA			1.1/1.2/1.2 kV at 10 kA	1 kV	6 kA 10 kA	integrated protection	no		
0039 53 0039 73	T2+T3/12 kA	3P+N	TT, TNS	275 V~	CT2	10/20 kA	20 kA									

CT1: L(N)-PE protection modes.

CT2: L-N and N-PE protection modes.

1: DPX³ (with T1 SPDs), DX³ or similar type circuit breakers (with T2 and T1+T2 SPDs). For fuse protection or values other than those indicated in the table: please consult Legrand.

Characteristics of proximity SPDs

230 V~ protection: Type 3 (T3) SPDs

Cat.Nos	0775 40	6946 64/66/70	6946 14/48/51/56/71
Protection mode	LN/NPE	LN/LPE/NPE	LN
Up	1/1.2 kV	1 kV	1 kV
I _{max}	6 kA	-	-
I _n	1.5 kA	2 kA	2 kA
Uoc	3 kV	4 kV	4 kV

TT earthing system: Installation downstream of a residual current device (HPI type recommended).

RJ 45/RJ 11 protection

Cat. No.	6946 64	6946 70
Uc	200 V	
Up	600 V	
I _{max}	1.5 kA	
I _n	1 kA	
Uoc	3 kV	

TV protection (9.5 mm coax.)

Cat. No.	6946 66
Uc	50 V
Up	900 V
I _{max}	5 kA
I _n	1 kA
Uoc	3 kV

Surge Protective Devices (SPDs)

technical characteristics

Installation

Associated overcurrent protection

SPDs must be protected by a circuit breaker (or fuses), to provide protection in the event of an overload, which may make the SPD reach its end of life (see selection table p. 10-11). This protective device will be defined to be coordinated or discriminating with regard to upstream protective devices.

Connection principles

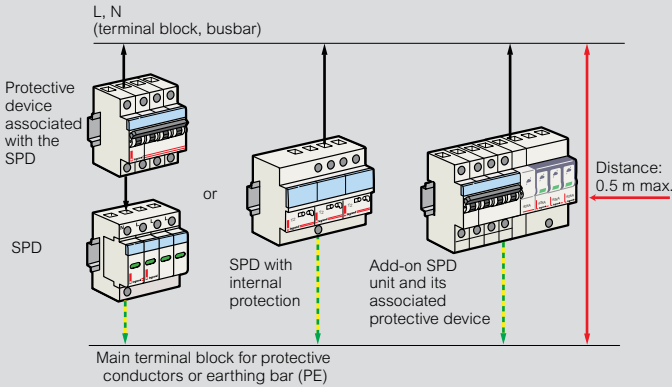

Connection lengths: as short as possible (< 50 cm if possible).
EMC (Electromagnetic Compatibility) rules: avoid loops, fix the cables firmly against the exposed metal conductive parts of the enclosure.

SPD types and earthing systems

When possible (according to local rules), the SPD and its associated overcurrent protection (P2) should be installed upstream of the main protection (P1) as shown below (according to standards HD/IEC 60364).

SPDs and TT earthing system

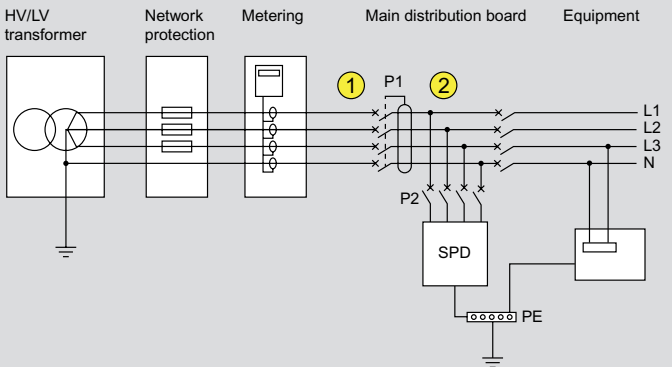

P1: main protection of the installation
SPD: surge protective device with U_c 275 or 320 V recommended
① (upstream of P1): 1P+N/3P+N SPDs only (except for Cat.Nos 0039 51/53/71/73). 1P/2P/3P/4P SPDs and Cat.Nos 0039 51/53/71/73 must always be installed downstream of a residual current device (discriminating or delayed, at the supply end of the installation).
② (downstream of P2): any SPD.

SPDs and TN (TNC, TNS and TNC-S) earthing systems

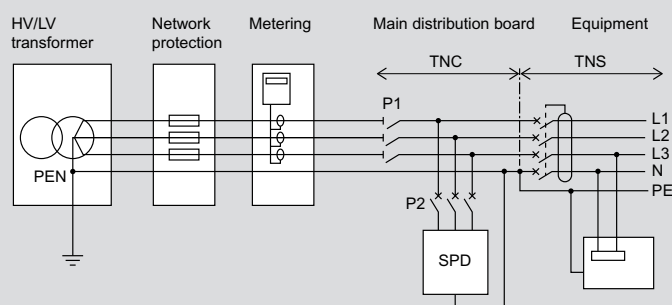

P1: main protection of the installation
SPD: surge protective device with U_c 275 or 320 V recommended

SPDs and IT earthing system

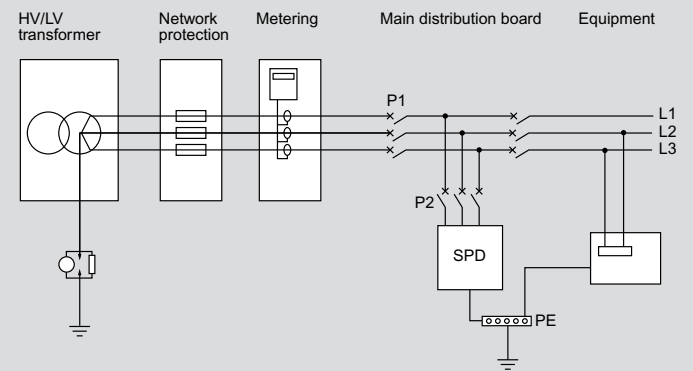

P1: main protection of the installation
SPD: surge protective device with U_c 440 V ($U_c < 440$ V prohibited)

Coordinating upstream/downstream SPDs

Consists of ensuring that any downstream SPD (in distribution enclosures or proximity SPDs) is correctly coordinated in energy terms with any SPD located upstream (TS 61643-12).

Minimum distances between SPDs

Upstream SPD	Downstream SPD	Min. distance (m)
T1/50 and T1/25	T2/40	10
T1/12.5 and T1/8	T2/40	6
	T2/20, T2/12	8
T2/40	T2/20	4
	T2/12	6
T2/20 and T2/12	Proximity SPD	2

If it is not possible to comply with these distances, insert decoupling inductors on each phase and neutral conductor.

DX³

modular din-rail products

■ Dimensions

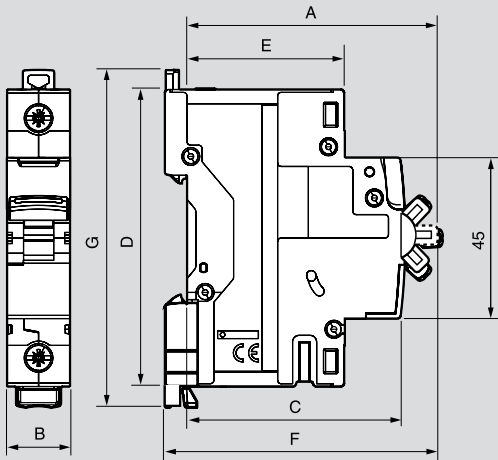

Products	A	B						C	D	E	F	G
		SP	SPN	DP	TP	TPN	FP					
DX ³ MCBs (0.5 to 63 A)	70	17.7	35.6	35.6	53.4	71.2	71.2	60	83	44	76	94
DX ³ MCBs (80 - 125 A)	70	26.7	-	53.4	80.1	-	106.8	60	83	44	76	89
DX ³ Isolators	70	-	-	35.6	53.4	-	71.2	60	83	44	76	94
DX ³ RCCB - type AC (DP)	70	-	-	35.6	-	-	-	60	83	44	76	94
DX ³ RCCB - type AC (FP)	71.5	-	-	-	-	-	71.2	60	83	44	77.5	94
DX ³ RCCB - type A - S (DP)	70	-	-	35.6	-	-	-	60	83	44	76	94
DX ³ RCCB - type A - S (FP)	71.5	-	-	-	-	-	71.2	60	83	44	77.5	94
DX ³ RCCB - type Hpi (DP)	70	-	-	35.6	-	-	-	60	83	44	76	94
DX ³ RCCB - type Hpi (FP)	71.5	-	-	-	-	-	71.2	60	83	44	77.5	94
DX ³ RCBO - type AC	70	-	-	71.2	-	-	142.4	60	83	44	76	94
DX ³ RCBO - type AC (DP 2 mod.)	70	-	-	35.6	-	-	-	60	83	44	76	94
DX ³ RCBO - type Hpi (DP 2 mod.)	70	-	-	35.6	-	-	-	60	83	44	76	94
Auxiliary contacts	70	8.7						60	83	44	76	83
Auxiliary contacts	70	17.7						60	83	44	76	83
Shunt trip	70	17.7						60	83	44	76	83
Minimum voltage trip	70	17.7						60	83	44	76	83
POP over voltage	74	54						74	83	44	80.5	89
Remote control for MCB / RCBO	74	54						74	83	44	80.5	89
CX ³ contactors 20 A	62	17.8						60	83	44	67.5	-
CX ³ contactors 40 A (2 mod.)	60	35.6						61	80	44	67	-
CX ³ contactors 40 A / 63 A (3 mod.)	60	54						61	80	44	67	-
CX ³ change over switches	74	17.7						68	83	44	74	94
CX ³ pushbutton & control switches	66.65	17.8						43.85	84.5	43.85	61	94.9
CX ³ LED indicators	62	17.8						43.85	84.5	43.85	61	94.9

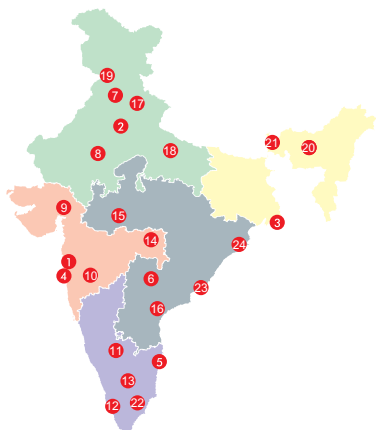

Head office

- 61 & 62, 6th Floor,
Kalpataru Square, Kondivita Road,
Off Andheri-Kurla Road, Andheri (E),
MUMBAI - 400 059.
Tel : (022) 3041 6200
Fax : (022) 3041 6201
Website : www.legrand.co.in

Regional sales offices

- A-25, Mohan Co-operative
Industrial Estate, Mathura Road,
NEW DELHI - 110 044.
Tel : (011) 2699 0028 / 29 / 30, 3990 2200
Fax : (011) 2699 0047
- Bhakta Towers, 2nd & 3rd Floor,
Plot No. KB 22, Salt Lake, Sector - 3,
KOLKATA - 700 098.
Tel : (033) 4021 3535 / 36
Fax : (033) 4021 3537
- 34, 3rd Floor, Kalpataru Square,
Kondivita Road, Off Andheri-Kurla Road,
Andheri (East),
MUMBAI - 400 059.
Tel : (022) 3385 6200
Fax : (022) 3385 6201
- Gee Gee Universal,
8th Floor, Door No. 2, 18/1 & 18/2,
McNichols Road, Chetput,
CHENNAI - 600 031.
Tel : (044) 3024 7200, 2836 4165 / 67 / 68
Fax : (044) 2836 4169
- 205-208, 2nd Floor, Block - II,
White House, Kundan Bagh, Begumpet,
HYDERABAD - 500 016.
Tel : (040) 2341 4398 / 67, 4567 1717
Fax : (040) 6636 6974

Branch offices

- SCO 1-2-3,
Second Floor, Sector 17B,
CHANDIGARH - 160 017.
Tel : (0172) 305 8631 / 32 / 33 / 34 / 35
Fax : (0172) 501 9008
- 507-510, Vth Floor, Soni Paris Point,
Jai Singh Highway, Banipark,
JAIPUR - 302 016.
Telefax : (0141) 511 3129
- 504, Sakar IV,
Opp. M. J. Library, Ellis Bridge,
AHMEDABAD - 380 006. Gujarat
Tel : (079) 2658 6561 / 2
Fax : (079) 2658 6563
- 402, Swastik Chambers,
Near Ashwamegh Marriage Hall,
Behind HP Petrol Pump,
Off Karve Road, Erandwane,
PUNE - 411 004.
Tel : (020) 6729 5600 / 601
Fax : (020) 6729 5604
- 11nd Floor, Al-Latheef Building,
2/1, Union Street, Off. Infantry Road,
BANGALORE - 560 001.
Tel : (080) 2286 1081, 4113 3293 / 4
Fax : (080) 2286 1078
- No. 36/2178, Syda Building, 2nd Floor,
Kaloor - Kadavanthra Road, Kaloor,
KOCHI - 682 017.
Tel : (0484) 234 2921, 658 0921
Fax : (0484) 233 3921
- B-15, Thirumalai Towers,
IV-D, Fourth Floor,
723, Avanasli Road,
COIMBATORE - 641 018.
Tel : (0422) 650 2728, 222 3634 / 0283
Fax : (0422) 222 3164
- Plot No.95, II Floor, Shreyash Heights,
Ramdas Peth, VIP Road,
NAGPUR - 440 010.
Tel : (0712) 662 7857 / 58
Fax : (0712) 662 7859
- 204-205, Megapolis Square,
579, M G Road,
INDORE - 452 001.
Tel : (0731) 393 1650 / 51 / 52
Fax : (0731) 393 1653
- MF-2, Datta's Lords House,
Jammi Chettu Street,
VIJAYAWADA - 520 010.
Tel : (0866) 661 1393, 664 6393
Fax : (0866) 669 9393

Area offices

- ABC Business Club 16,
Tagore Villa,
Chakrata Road,
DEHRADUN - 248 001.
Uttaranchal.
Tel : (0135) 271 5189 / 248 001
- Cabin No.104/105,
Trade Point,
Ground Floor,
Saran Chamber 1,
5, Park Road, Hazratganj,
LUCKNOW - 226 001.
Tel : (0522) 223 9044 / 7285
Fax : (0522) 223 9124
- Cabin No. 9,
Second Floor,
Madhok Trade Centre,
Madhok Complex,
Ferozpur Road,
LUDHIANA - 141 001.
Tel/Fax No.: (0161) 277 0301 / 304
- House No. 97,
Ground Floor,
Rajgarh Main Road,
Opp. City Heart Nursing Home,
GUWAHATI - 781 007.
Tel : (0361) 245 8498
- 94, Udham Singh Sarani,
Ground Floor, Ashrampara,
SILIGURI - 734 001.
Tel : 94341 91635 / 98009 77780
- Aparna Towers, 1st Floor,
2/3, Bypass Road,
MADURAI - 625 010.
Telefax : (0452) 230 8414
- 404, Eshwar Plaza,
Dwaraka Nagar, Main Road,
VISHAKHAPATNAM - 530 020.
Tel : (0891) 663 5652
Fax : (0891) 663 9363
- Plot No. 359,
Saheed Nagar, 2nd Floor,
BHUBANESWAR - 751 007.
Tel : (0674) 254 0623

Technical assistance from Legrand

Telephonic technical assistance for selection of products, technical information, guidance, wiring diagrams and estimation is now made available to you at each Regional Office. Contact the Technical Officer of Legrand at the following telephone numbers

- New Delhi** : Tel.: (011) 2699 0028 / 29 / 30, 3990 2200
Kolkata : Tel.: (033) 4021 3535 / 36
Mumbai : Tel.: (022) 3385 6200
Chennai : Tel.: (044) 3024 7200, 2836 4165 / 67 / 68
Hyderabad : Tel.: (040) 2341 4398 / 67, 4567 1717

For other places, contact the nearest
Regional / Branch / Area offices

customer.care@legrand.co.in

