



Earthing systems guide

Planning, execution and practical implementation

OBO Construct planning aids

Digital selection aids for earthing systems and surge protection

The OBO Construct electronic planning aids are programs developed to support electrical installation engineers and planners in the design of electrical installation systems. In particular, in complex areas such as surge protection and earthing, there are countless technical and standard general conditions to be observed. The two OBO Construct programs for earthing and surge protection systems should provide active help here. Systematic questions simplify the search for suitable products and guaranteed surge protection systems and earthing systems which fulfil the standards.

OBO Construct for earthing systems

The digital selection aid can be used for the easy planning and configuration of earthing systems. The simple and intuitive user guidance leads you through the individual components of the earthing system step by step. The software then automatically calculates the amounts required and the matching accessories. The application can be opened on any end device irrespective of its operating system – be it smartphone, tablet or desktop PC.

Benefits

- Time and place-independent work assistance
- Transmit planning requirements to complete product systems
- Find suitable products quickly and simply
- Calculate material and parts lists automatically
- Download configuration results as Excel or Word files



Contents

1.	Basic principles	4
2.	Normative requirements	4
3.	Earthing systems and their materials	5
3.1	Individual foundations	6
3.2	Foundation earth electrodes	6
3.3	Labelling the connection lugs	8
3.4	Insulated earthing systems	9
3.5	Lightning protection earthing	14
3.5.1	Earth rod – type A	15
3.5.2	Ring earther – type B	17
3.6	Potential control against step voltages	18
3.7	Touch voltage	20
3.8	Short-circuit current carrying capacity of earthing components (50 Hz)	21
3.9	Antenna earthing according to VDE 0855-1 (EN/IEC 60728-11)	23
3.10	Earthing systems for wind power plants	25
4.	Documentation	27
5.	Conclusion	28
6.	OBO selection aid for foundation and ring earthers according to DIN 18014 and IEC/EN 62305-3 (VDE 0185-305-3)	28
7.	Literature notes	30

This guide is based on the currently known and valid rules and regulations, and on our experience.
The contents are not legally binding and make no claim to completeness.

1. Basic principles

The earthing system is the basis for the safe function of every electrical system and its protection devices. It ensures operation and protects people against hazardous currents. Buildings with IT systems and data cabling have high requirements for electromagnetic compatibility measures (EMC). To ensure the EMC shield and personal protection, meshed equipotential bonding and a low-ohmic earthing system integrated in the structure are required.

2. Normative requirements

The earthing system creates the electrical connection to the surrounding earth. The earthing resistance of the system should be as small as possible (less than 10 Ω) and must be coordinated with further protective measures and switch-off conditions.

The equipotential bonding based on the earthing system fulfils the following functions:

- Protection against electric shock – IEC 60364-4-41
- Protective equipotential bonding – IEC 60364-5-54
- Lightning protection equipotential bonding – IEC 62305
- Energy systems and surge protection – IEC 60364-4-44
- Low-voltage electrical installations – IEC 60364-5-54
- Data cabling and shielding – EN 50310
- Electromagnetic compatibility – EMC Directive 2004/108/EC (EMVG)
- Antenna earthing – IEC 60728
- Application of equipotential bonding and earthing in buildings with information technology equipment – EN 50310
- Electrical installations in residential buildings – DIN 18015-1
- Foundation earth electrodes– DIN 18014

In Germany, the foundation earth electrode in new buildings must meet the requirements of DIN 18014 and the technical connection conditions (TAB) of the power supply generator (VNB).

Note

Section 542.1.1 of IEC 60364-5-54: "For protection and function purposes, earthing systems may be used together or separately, according to the requirements of the electrical system. The protection requirements must always have priority."

The earthing system thus represents a safety-relevant part, and installation is only permitted if performed by an electrical or lightning protection specialist. In addition, the responsible specialist must be stated in the prescribed documentation.

The following infringements of the rules of technology are specified in § 319 "Causing danger during construction work" of the German Criminal Code:

1. Whosoever, in the planning, management or execution of the construction or the demolition of a structure, violates generally accepted engineering standards and thereby endangers the life or limb of another person shall be liable to imprisonment not exceeding five years or a fine.
2. Whosoever, in engaging in a profession or trade, violates generally accepted engineering standards in the planning, management or execution of a project to install technical fixtures in a structure or to modify installed fixtures of this nature and thereby endangers the life or limb of another person shall incur the same penalty.
3. Whosoever causes the danger negligently, shall be liable to imprisonment not exceeding three years or a fine
4. Whosoever, in cases under subsections (1) and (2) above, acts negligently and causes the danger negligently shall be liable to imprisonment not exceeding two years or a fine.

The earthing system is a part of the electrical system. Only electrical or lightning protection specialists may install, check and accept the earthing system. Construction companies must allow the supervision of the installation and acceptance of the earthing system by electrical and lightning protection specialists.



Installing a foundation earth electrode

3. Earthing systems and their materials

The standards specify that each system must include an earthing system.

What do we mean by an "earthing system"?

We can find the required definitions in IEC 60050-826 – Low-voltage electrical installations: Terms.

- "Totality of the electrical connections and equipment used to earth a network, a system or a resource." Also:
- "Conductive element, embedded in the earth or in another specific conductive medium in electrical contact with the earth."

The tasks of an earthing system are:

- Arresting of the lightning current into the earth
- Equipotential bonding between the down-conductors
- Equipotential bonding near conductive walls of the building structure

Consequences of an improperly created earthing system:

- Dangerous surge voltages at the equipotential bonding
- No even potential course on the earthing system
- Destruction of the foundation through insufficient arresting area of the energy-rich lightning current
- Destruction of the foundation through improperly made connections (no terminal connection)
- Electrical decoupling of high amounts of lightning energy

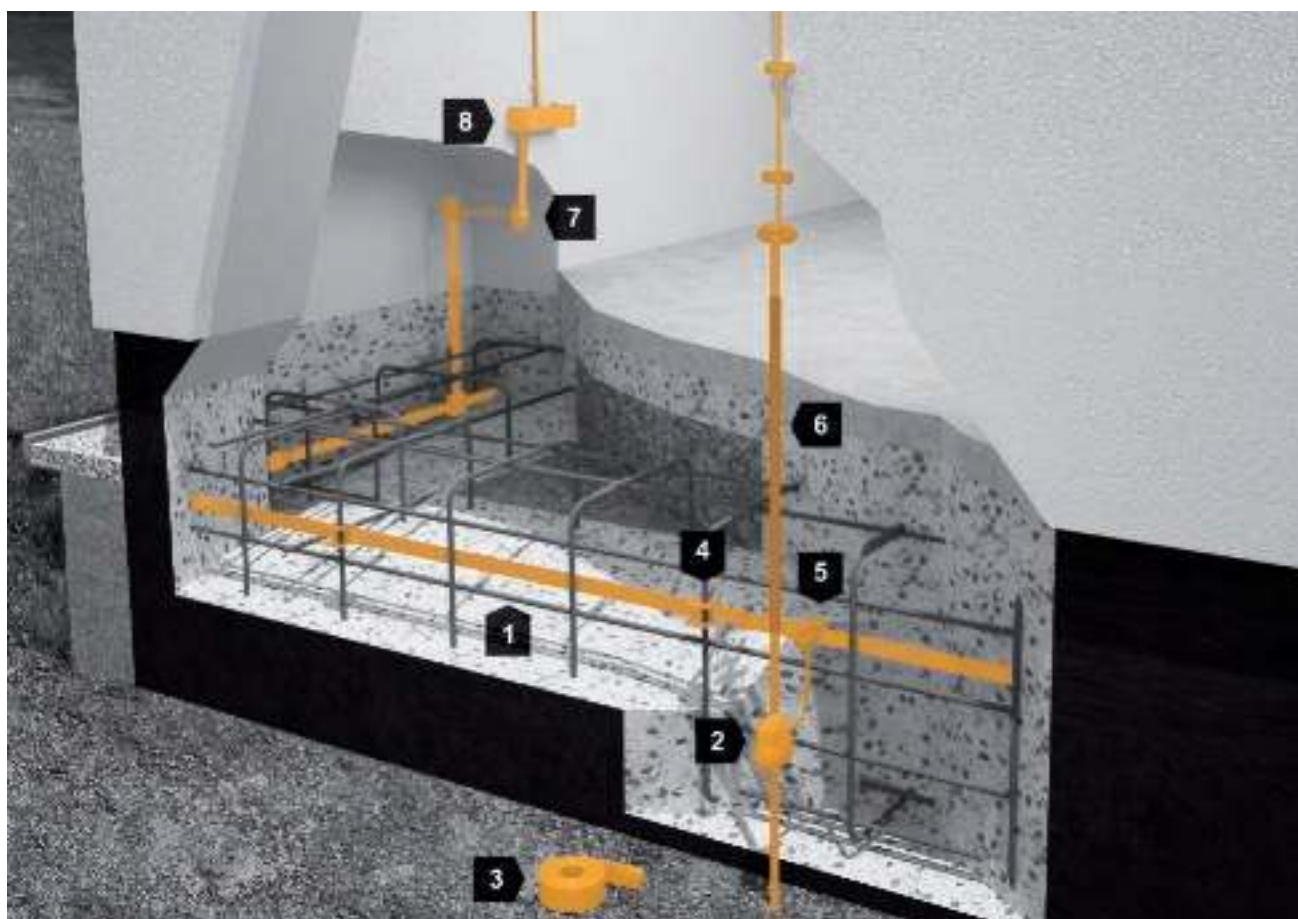

Type B foundation earth electrode

1	Flat conductor
2	Cross-connector with corrosion protection
3	Corrosion protection strip
4	Connection terminal for reinforced steels
5	Cross-connector
6	Earth lead-in rod
7	Earthing fixed point
8	Main earthing busbar (MEB)

3.1 Individual foundations

Individual foundations, e.g. for supports, must have a foundation earth electrode with a length of at least 2.5 m. These foundations should be conductively connected and the maximum grid width of 20 x 20 m may not be exceeded. The corrosion resistance of the individual foundations and the connection cables must be ensured using suitable measures and materials.

3.2 Foundation earth electrodes

A foundation earth electrode is a closed ring, ideally consisting of flat conductors or, alternatively, of round conductors, with a maximum grid width of 20 x 20 m. The foundation earth electrode is connected to the reinforcement at a spacing of approx. 2 m using clamping connectors. To ensure corrosion protection, the foundation earth electrode must be embedded in the concrete with a jacket of at least 5 cm. The concrete sets up the electrical connection between the foundation earth electrode and the earth.

Note!

According to the foundation earth electrode standard DIN 18014, wedge connectors are not approved for use in mechanically compacted concrete. Screwed-on connectors, for example, are considered secure connections.

If the concrete is insulated, then there need be no electrical connection to the earth. The insulation means that the concrete dries out to a great extent. This is the case, for example, with versions as a black trough, with perimeter insulation or as a white trough. To achieve constant earthing resistance, the ring earther must be attached in contact with the earth in moist, frost-free earth outside the foundation. This should be taken into account particularly in the case of large roof overhangs. In this case, a ring earther must additionally be used outside or beneath the concrete foundation. This ring earther in contact with the earth is connected to the functional equipotential bonding conductor of the foundation.

Note!

Systems with high electromagnetic compatibility (EMC) requirements require a powerful foundation earth electrode. In this case, to reduce the impedance, the grid width may not be 20 x 20 m, but usually only 5 x 5 m (VDE 0185-305-4/IEC 62305-4).

The foundation earth electrode can also be used as a lightning protection earther. To allow the connection of the lightning protection system, the connection lugs required for the down-conductors must protrude from the foundation. The materials must correspond to the lightning protection standard VDE 0185-305-3 Table 7 (IEC 62305-3) or the lightning protection components standard VDE 0185-561-2 ed. 2 (IEC 62561-2).

Note!

Floor plates made of steel fibre concrete do not fulfil the corrosion protection requirements with a 5 cm concrete jacket. Before concreting, a ring earther of stainless steel quality V4A (1.4404/316L or 1.4571/316Ti) must be created.

Note!

Connections in the earth must be protected with a corrosion protection strip.

Versions of foundation earth electrodes**Dimensions**

- Round steel (min. diameter 10 mm)¹
- Strip steel (min. dimensions 30 mm x 3.5 mm)¹

¹ For transformer stations, VDE 0101 (EN 61936) states that larger cross-sections may be necessary for the maximum short-circuit currents which occur.

Materials

- Bright and non-galvanised steel (use only with at least 5 cm concrete cladding)
- Stainless steel of quality V4A, e.g. material no. 1.4404/316L or 1.4571/316Ti (can be used in concrete jackets or directly in the earth)
- Copper (can be used in concrete jackets or directly in the earth)

All metals in contact with the ground or water can corrode. Electrochemical corrosion occurs when different metals are connected with one another in soil, water or molten salt. It can also occur when a single type of metal is embedded in two distinct environments, e.g. steel in earth and concrete.

Material	Form	Minimum dimensions		
		Earth rod	Earth conductor	Earth plates
Copper Tin plated copper	Cable		50 mm ²	
	Round, solid		Ø 8 mm	
	Strip, solid		20 x 2.5 mm	
	Round, solid	Ø 15 mm		
	Pipe	Ø 20 mm		
	Solid sheet			500 x 500 mm
	Grid mesh			600 x 600 mm
Hot galvanised steel	Round, solid		Ø 10 mm	
	Round, solid	Ø 14 mm		
	Pipe	Ø 25 mm		
	Strip, solid		30 x 3 mm	
	Solid sheet			500 x 500 mm
	Grid mesh			600 x 600 mm
	Profile (a)	290 mm ²		
Bright steel (b)	Cable	Ø 8 mm	70 mm ²	
	Round, solid		Ø 10 mm	
	Strip, solid		25 x 3 mm	
Copper-coated steel	Round, solid (c)	Ø 14 mm		
	Round, solid (c)		Ø 8 mm	
	Round, solid (d)		Ø 10 mm	
	Strip, solid		30 x 3 mm	
Rustproof steel (e)	Round, solid		Ø 10 mm	
	Round, solid	Ø 15 mm		
	Strip, solid		30 x 3.5 mm	

- (a) Various profiles with a cross-section of 290 mm² and a minimum thickness of 3 mm are permitted, e.g. cross profiles
(b) Must be embedded in concrete to a depth of at least 50 mm
(c) With at least 250 µm copper support with 99.99% copper content
(d) With at least 70 µm copper support with 99.99% copper content
(e) Chromium ≥ 16%; nickel ≥ 5%; molybdenum ≥ 2%; carbon ≤ 0.08%

Materials, form and cross-section of earthers according to VDE 0185-561-2 ed. 2

3.3 Labelling the connection lugs

During the construction phase, metal connection lugs pose a risk of injury to people. For this reason, the connection lugs of the earthing system must be marked clearly during the entire construction phase (DIN 18014).



Protective cap for flat and round conductors, retroreflective
ProtectionBall, item no. 5018014

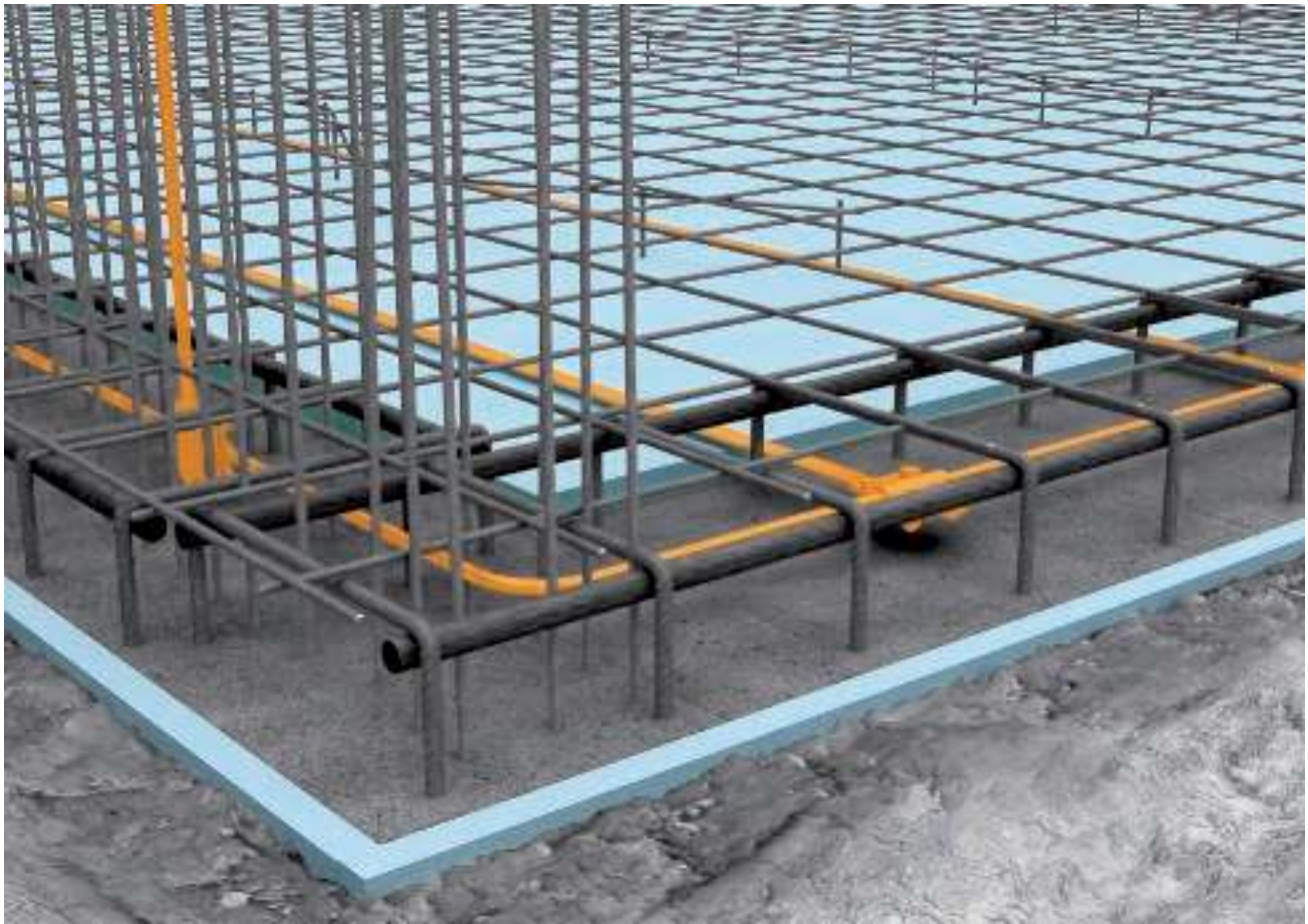

Insulated floor plate (perimeter insulation, shown here in blue)

3.4 Insulated earthing systems

If the concrete is insulated, then there need be no electrical connection to the earth. The insulation means that the concrete dries out to a great extent. This is, for example, the case with the following versions:

- Perimeter insulation: Heat insulation on the underside and side walls of the foundations
- Black trough: Seals with bitumen strips or polymer-modified bitumen thick coating (KMB)
- White trough: Water-impermeable (WU) concrete to DIN 206-1 and 1045-2 of the quality \geq C25/30
- Poorly electrically conductive earth strata, e.g. made of recycled material or crushed glass

In these cases, a ring earther must additionally be used outside or beneath the concrete foundation. This ring earther in contact with the earth is connected to the functional equipotential bonding conductor of the foundation. If the earther is installed under the floor plate of the insulated foundation, then the following grid width must be maintained:

- 10 x 10 m with lightning protection measures
- 20 x 20 m without lightning protection measures

Note!

For this reason, in large buildings, the earthing system must be installed before the concrete work.

Perimeter insulation

Perimeter insulation is created from heat-insulation plates and is used beneath floor plates and on cellar walls. The use of perimeter insulation does not create an electrically conductive connection between the concrete foundation and the earth.

Perimeter insulation surrounding on all sides

If all the walls, foundations and the bottom of the foundation are surrounded by the perimeter insulation of the structure, then the function of the foundation earth electrode will be restricted or non-existent. For this reason, with insulated foundations, a ring earther must be installed in contact with the earth beneath the foundation and the insulation, in order to guarantee the standard-conformant function of the earthing system. Before installing the perimeter insulation, the earther of stainless steel quality V4A (1.4404/316L or 1.4571/316Ti) must be erected.

Perimeter insulation only on the surrounding walls

If the perimeter insulation is only on the surrounding walls, earther contact is often still intact. The foundation earth electrode can be implemented in the concrete. To ensure contact with the earth, no water-impermeable concrete (WU concrete) may be used.

Black trough

If the area of the building in contact with the earth is surrounded on all sides by a bitumen or plastic seal, this is known as a "black trough". Because, in this case, the foundation earth electrode no longer has contact with the earth here, an additional grid ring earther and functional equipotential bonding must be created in the foundation. The foundation earth electrode within the black trough is used for equipotential bonding.

Beneath the seal, there must be a second earthing system with at least the same grid width installed in the cleanliness layer or in the earth. Both earthing systems should be connected to each other. On buildings without a lightning protection system, the maximum spacing between the connections should be 20 metres around the periphery of the building. If there is a lightning protection system, there should be a connection on each down-conductor.

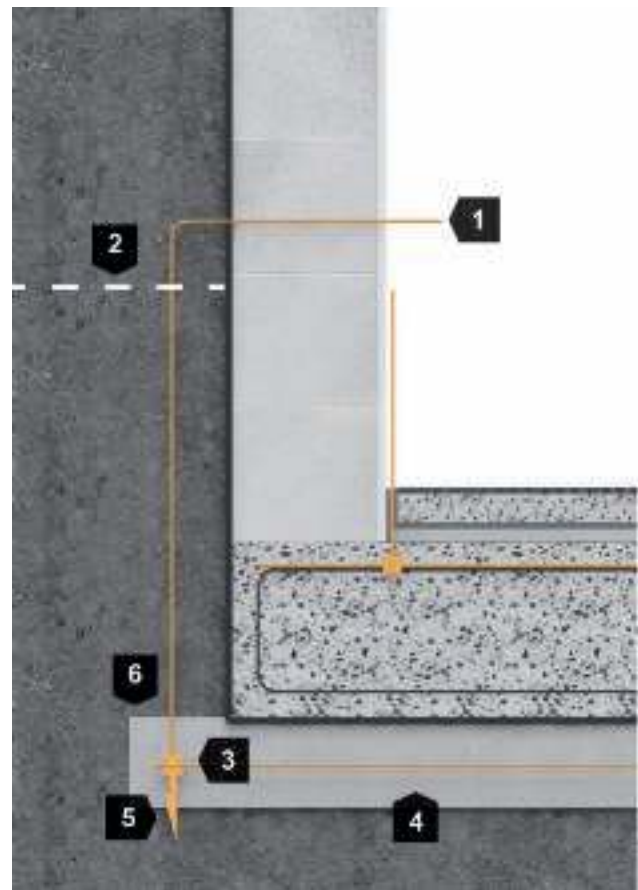

Black trough

1	Connection lug, min. 1.50 m
2	Maximum groundwater level
3	Ring earth electrode
4	Blinding layer
5	Spacer
6	Min. 5 cm concrete cladding is used as corrosion protection

White trough

A "white trough" is a construction consisting of water-impermeable concrete (WU concrete), in which water cannot penetrate right through the concrete. As with the black trough, there is no contact between the earth and the foundation earth electrode.

If there is a lightning protection system and an insulated foundation, two earthing systems must be installed:

- In the foundation: One earther with a 20 x 20 m grid width, in accordance with the foundation earth electrode standard DIN 18014.
- In the earth: One earther with a 10 x 10 m grid width, in accordance with the lightning protection standard VDE 0185-305-3 (IEC 62305-3)

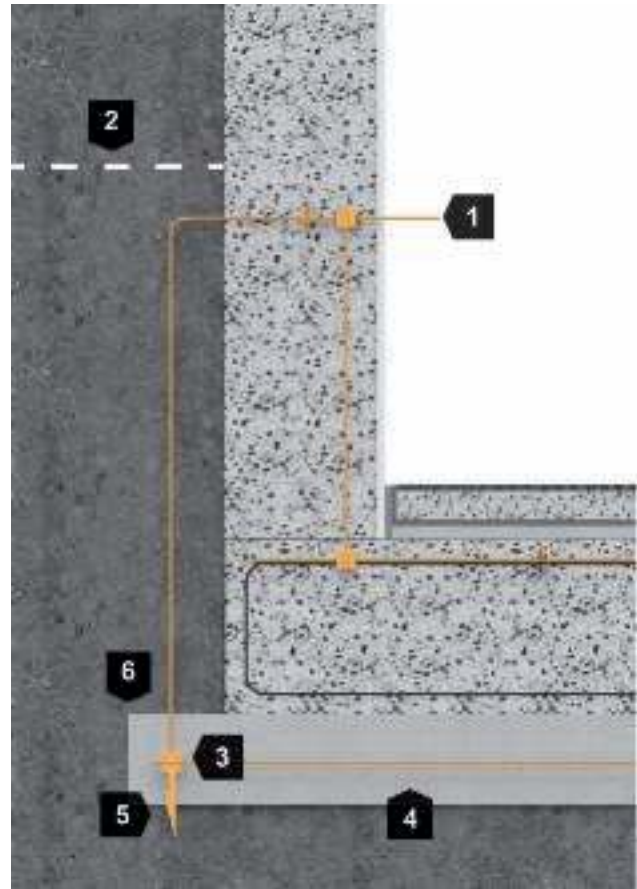

White trough

1	Connection lug, min. 1.50 m
2	Maximum groundwater level
3	Ring earth electrode
4	Blinding layer
5	Spacer
6	Min. 5 cm concrete cladding is used as corrosion protection

Sealing sleeves, expansion pieces and expansion strips

The insertion of the connection lugs into the building should take place above the highest groundwater level. If, for structural reasons, an insertion in the area of the groundwater is necessary, a pressure water-tested sealing sleeve must be used. It prevents the capillary ingress of water into the concrete.

According to VDE 0185-561-5 ed. 2, sealing sleeves must be tested with at least 1 bar of pressurised water for 72 hours.

Within the concrete, the foundation earth electrode may not be run over movement joints. Connection lugs should be run out of the wall with earthing fixed points and connected with flexible bridging parts made of copper or aluminium with a cross-section of at least 50 mm². The connection point can be checked at any time through the use of an expansion piece.

If this is not possible, an expansion strip can be used to pass the foundation earth electrode through the movement joint in expanded systems.



Sealing sleeve for round conductors, type DW RD10, item no. 2360041



Expansion piece, type 1807, item no. 5016142



Expansion strip, type 1807 DB, item no. 5016160



Bridging of movement joints with an expansion piece

3.5 Lightning protection earthing

The earthing system distributes the lightning current in the earth. A low earthing resistance (less than 10 Ω) is recommended. To minimise potential differences, all the system parts, such as the lightning protection, power supply and IT systems, must be connected to the same earthing system. The earthing system must arrest the lightning current into the earth with a low resistance, in order to avoid surge voltages. The external lightning protection system is connected to the earth via the earthing system.

If there is a lightning strike, a large voltage de-energises at the earthing resistor of the building. This voltage, de-energised by the building, generates a voltage funnel in the earth, endangering the people above it. At points with increased numbers of people, these hazardous potential differences should be reduced by installing additional parallel and meshed conductors around the foundation earth electrode as ring earthers in the earth.

<p>Type A</p> <ul style="list-style-type: none"> • Horizontal earth electrodes • Vertical earth electrodes (earth rods) 	<p>Type B</p> <ul style="list-style-type: none"> • Ring earth electrodes (surface earthers) • Foundation earth electrodes
--	--

External and internal lightning protection systems

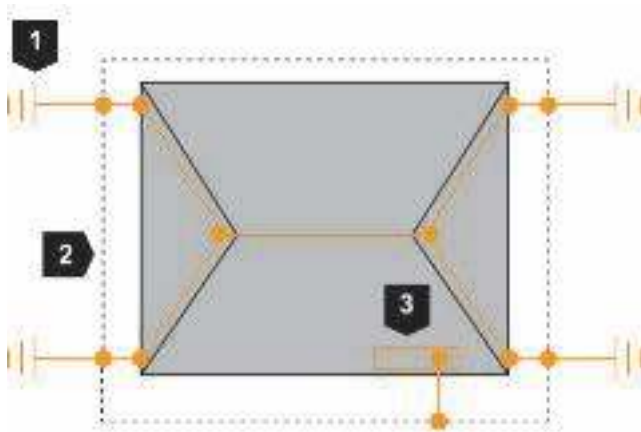

1	Earth rod, type A
2	Underground connection
3	Main earthing rail (MER)

Earthing system, type A: Connection outside the building structure

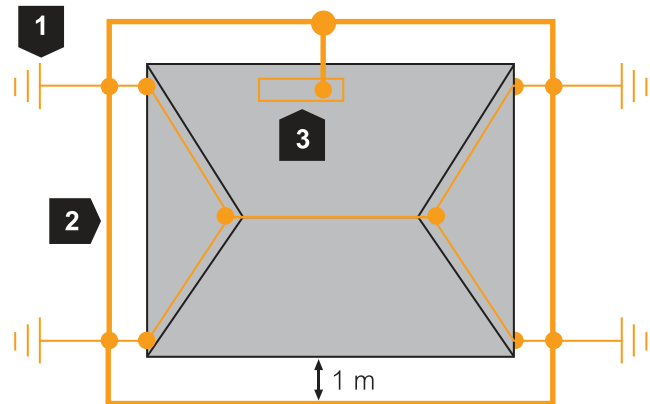

1	Earth rods (optional)
2	Underground connection
3	Main earthing busbar (MEB)

Installation principle, ring earther

3.5.1 Earth rod – type A

Earth rods are inserted vertically into the earth. The ideal installation depth is 9 m. This reaches the permanently moist areas in the earth. Good contact to the earth is created and the step voltage is also reduced. With a measured resistance of under 10 Ω, a sufficient installation depth can be assumed. A greater installation depth of the earth rod often only reduces the earthing resistance to a small extent. The earthing resistance must be checked on installation.

If the earthing resistance is not reduced at an increasing installation depth, parallel installation of multiple earth rods is wise. To minimise the mutual influence of the earth rods, the spacing of the parallel earthers must correspond to at least the length of the inserted earthers.

Note!

The individual earth rods must be interconnected and connected to the building earther. If the connection is not possible outside the building, then this can also take place in the building (cellar).

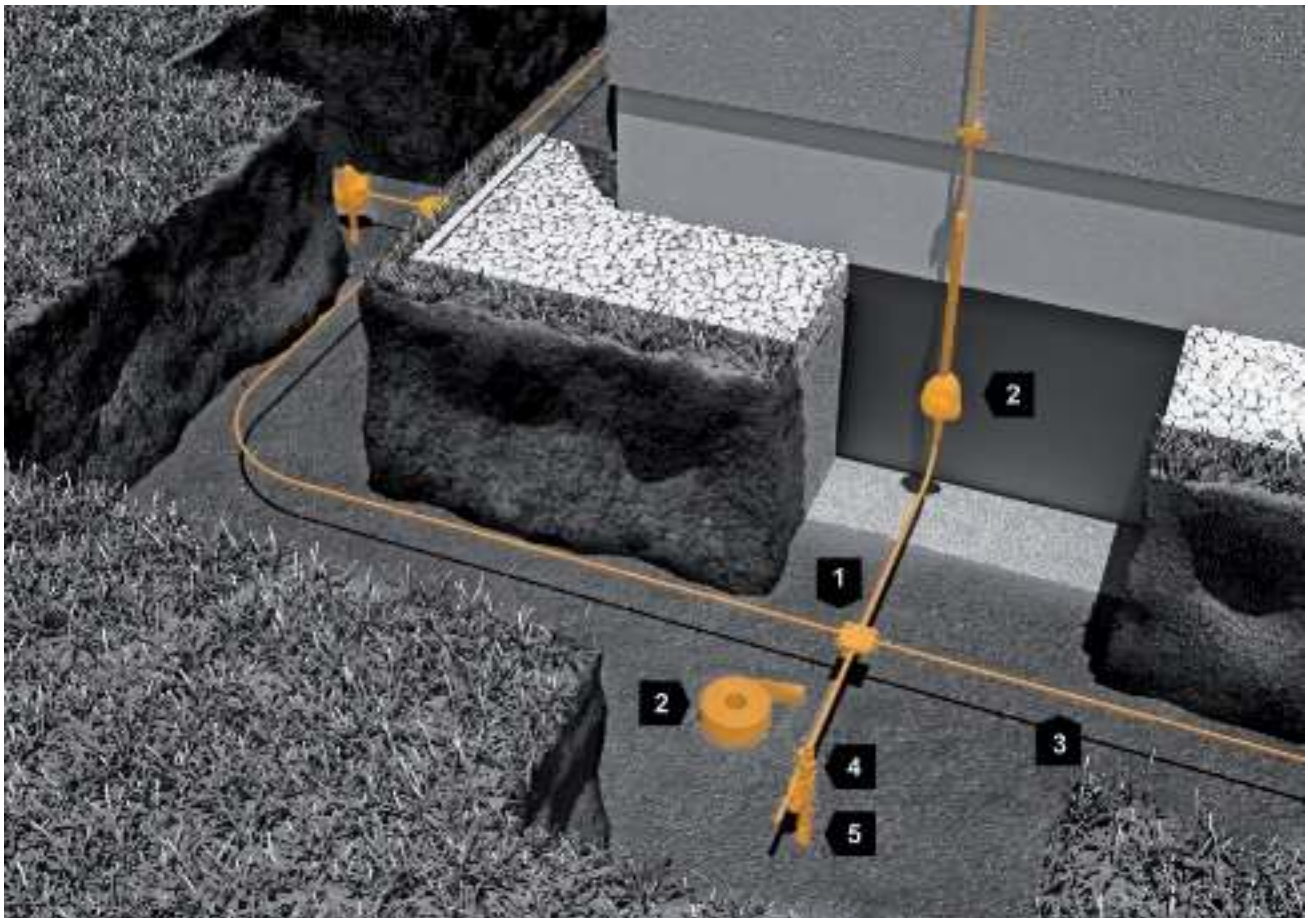

Type A earth rods with ring equipotential bonding

1	Cross-connector
2	Corrosion protection strip
3	Round conductor
4	Connection clips
5	Earth rods (observe corrosion protection for connectors)

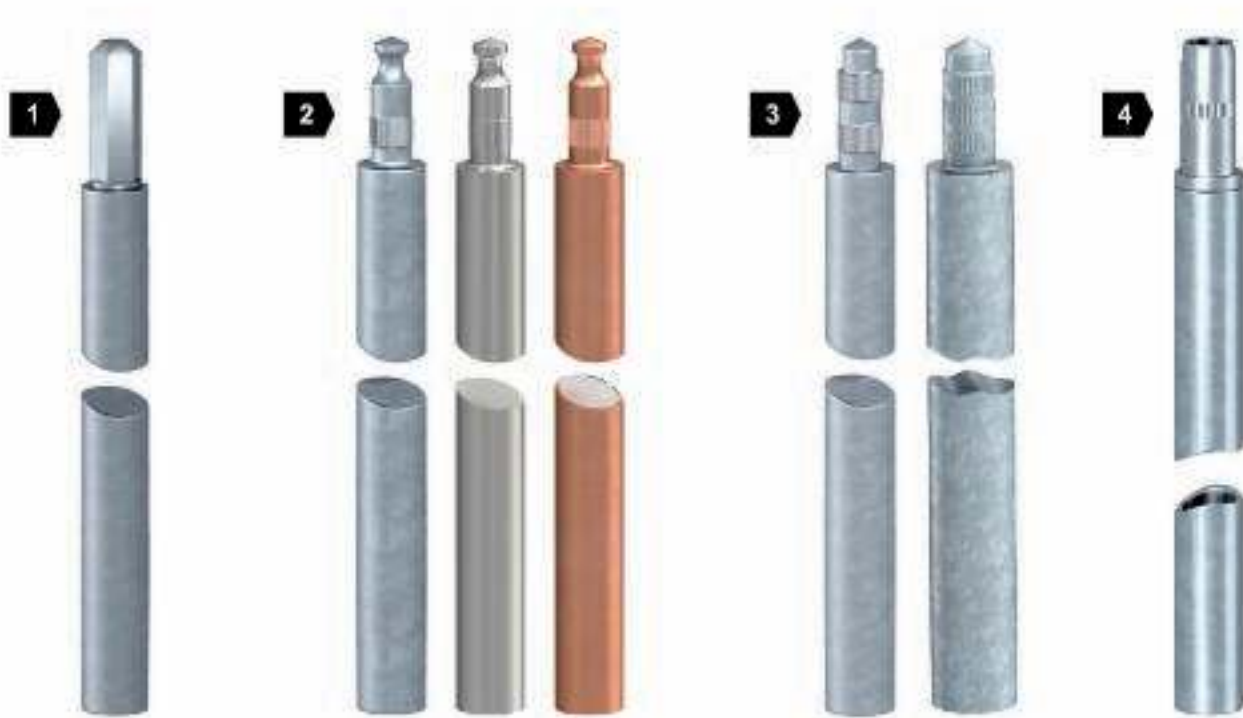

1	Type: OMEX	With soft metal inlay and hardened hexagonal pin for difficult soil conditions.
2	Type: BP	Very good contact properties through soft metal inlay in the bore.
3	Type: Standard	With double (Ø 20 mm) or triple (Ø 25 mm) knurling for strain-resistant connections.
4	Type: LightEarth	Earth rod with very little weight for light to medium-heavy ground conditions.

OBO earth rod versions

Earth rods are differentiated according to the type of connection of the individual earth rods, the external diameter, and the material.

Earth rods consist of combinable individual rods of length 1.5 m. The connection is made using a coupling consisting of a hole and stud. This has the advantage that the coupling closes automatically at the time of installation and creates a secure connection from both a mechanical and an electrical point of view. When an earth rod is driven in, this compacts the ground around it. This is conducive to a good electrical contact.

Striking tools are generally used for driving in the earth rods. The possible penetration depth of the earth rods depends on various geological factors.



Cross-section through the coupling of an OBO earth rod

3.5.2 Ring earther – type B

A ring earther is a closed ring of strip or round steel, created in the earth around the structure. For reasons of corrosion protection, the foundation earth electrode standard DIN 18014 stipulates that, in the earth, only the stainless steel quality V4A (1.4404/316L or 1.4571/316Ti) may be installed.

Note!

The ring earther should have direct contact with the earth along at least 80% of its length. Routing should be at least 0.5 metres deep (frost depth) and at a distance of 1.0 metres to the building.

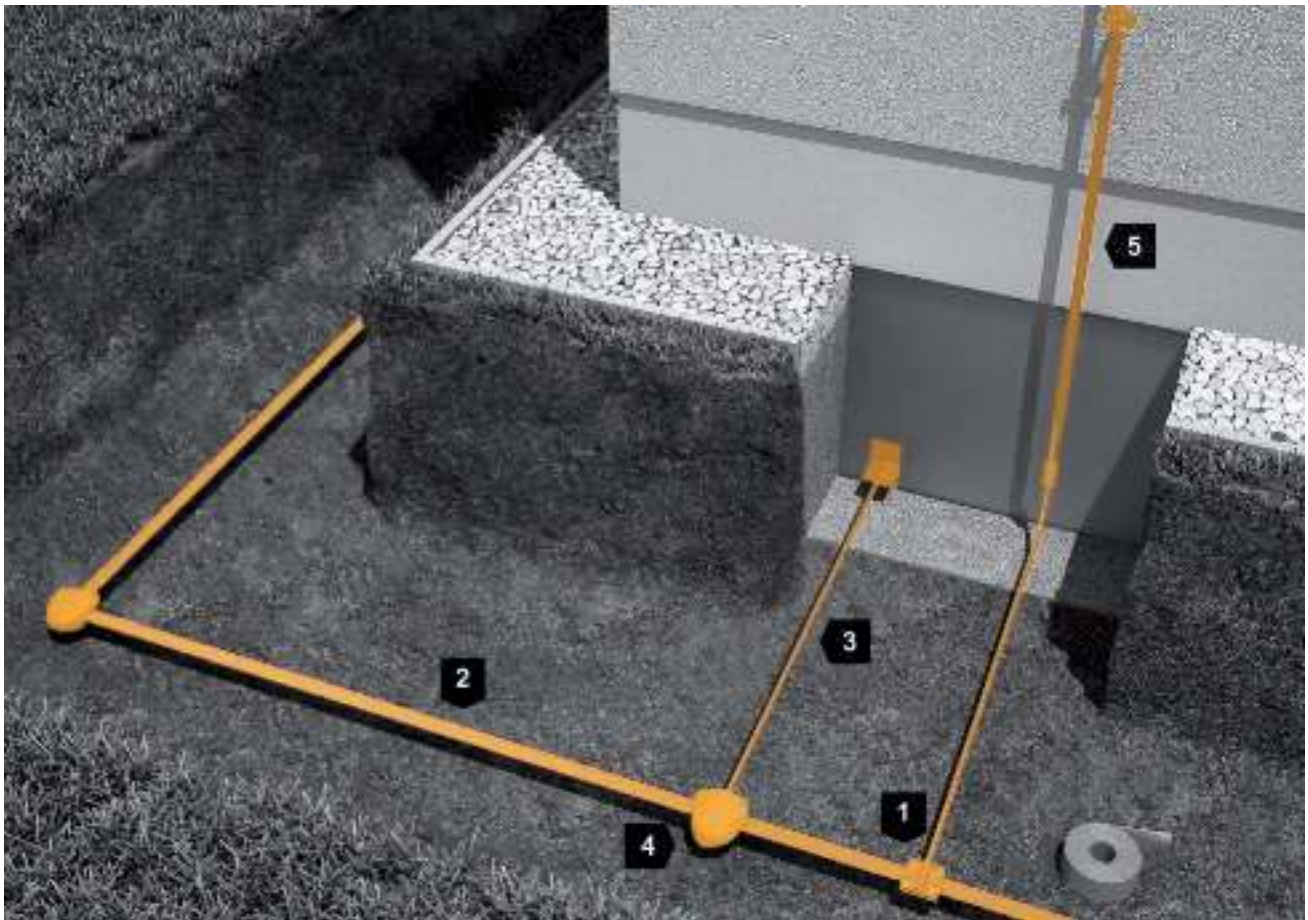

Type B ring earth electrode

1	Cross-connector
2	Flat conductor
3	Round conductor
4	Corrosion protection strip
5	Earth lead-in rod

3.6 Potential control against step voltages

The step voltage is the voltage between a person's feet placed 1 m apart. Here, the compensating current flows between the person's feet through their body. According to the state of the art, a value of 25 kV (10/350) is assumed as the lethal limit value. Equally important, as with any earthing system, is the specific earth resistance ρE . In entrance areas or in front of lookout towers, a densely looped earthing system is installed to minimise step voltage and to protect people.

The lightning current is distributed through the metallic earthing system. Additional earth rods at the outer edges of the potential control conduct the majority of the current into the earth. The voltage drop on the earth's surface and the resulting step voltage are reduced. Here, stainless steel of quality V4A (1.4404/316L or 1.4571/316Ti) should be used as a material.

Option 1: Potential control through ring earthers

Additional ring earthers are routed around the foundation earth electrode and connected with one another in a grid format. As the distance from the rod or down-conductor increases, the ring earther is routed 0.5 m deeper each time at the usual spacing of 3 m.

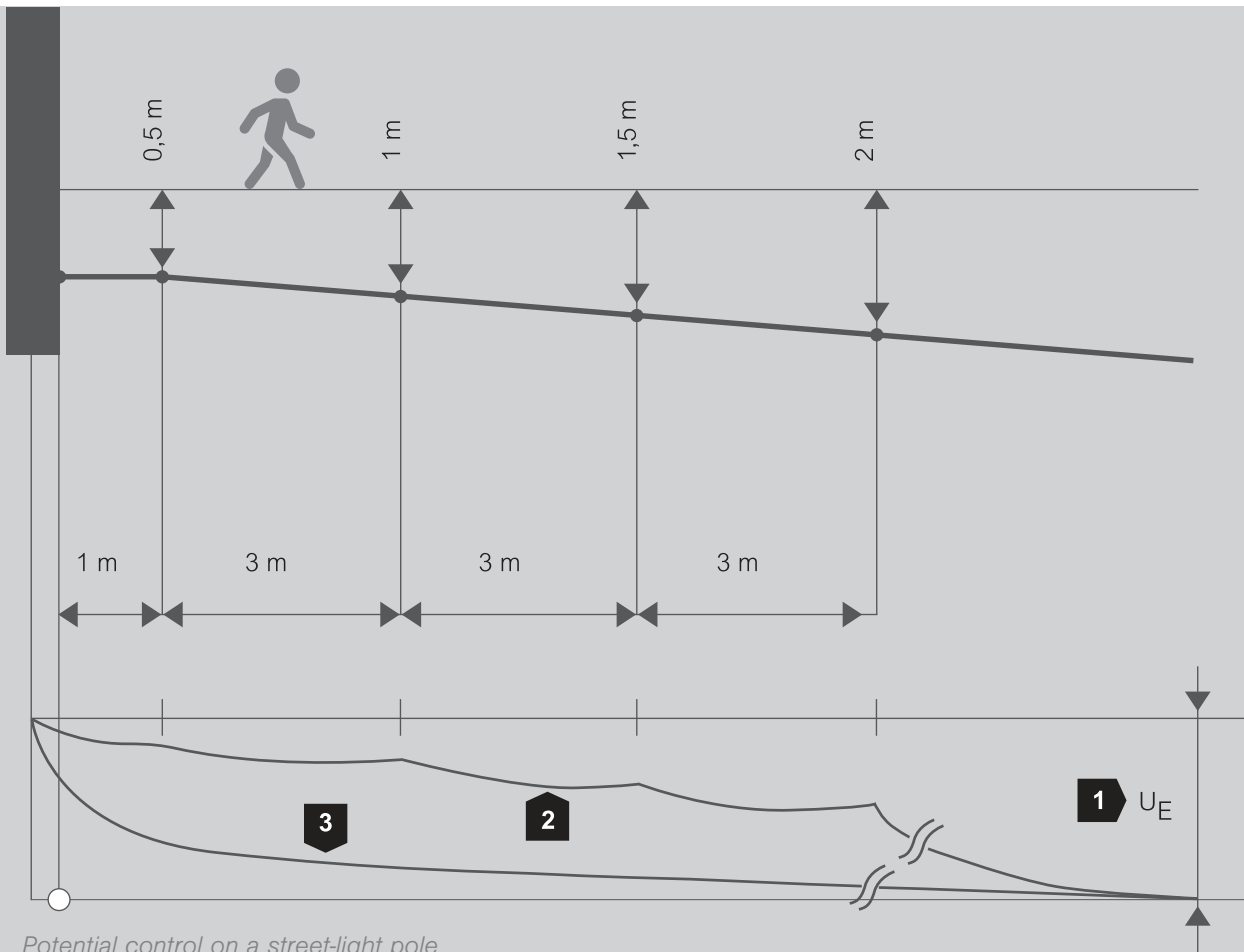

Potential control on a street-light pole

1	Earthing voltage U_E
2	With potential control
3	Without potential control

Option 2: Potential control through mesh grid

In refuges or transport stops, potential control through a tight metal grid is wise. The mesh is installed at a shallow depth (from 0.1 m to max. 0.25 m) below the earth's surface. The metal mesh should have a minimum diameter of 3 mm and a maximum grid width of 0.25 x 0.25 m. The actual grid width required can be determined with a detailed calculation using simulation software, and may deviate from the grid width specified above. For example, a simulation may show that even with a grid width of 0.5 x 0.5 m, the step voltage can be reduced to a value below the limit value (25 kV (10/350) for a ring earther of 10 x 10 m with a specific earth resistance of 1,000 Ohm and additional earth rods at the edge. To minimise the corrosion in the earth, the use of high-quality stainless steel V4A (1.4404/316L or 1.4571/316Ti) is necessary.

The mesh grids are screwed to each other using connection terminals and connected to the existing earthing system. This tightly meshed system greatly reduces the step voltage per metre, as well as touch voltage, and reduces the risk to people.

Note!

The equipotential lines are compacted directly at the end of the grids. This means the highest current density is to be expected at the edges of the mesh. The largest proportion of the current flows into the earth, which results in the highest voltage drop (step voltage). Additional earth rods should be installed here.

The tested isCon® Pro+ conductor provides further protection against dangerous contact voltage.

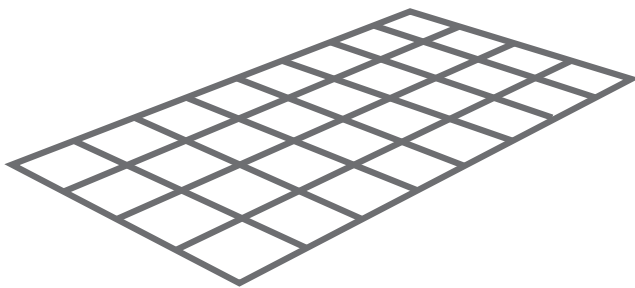

Mesh grid for potential control



Testing of the isCon® Pro+ conductor

3.7 Touch voltage

If there is a lightning stroke, the lightning current is routed through the down-conductors into the earthing system and the earth. The resistance of the down-conductor and the earth causes a voltage drop, which can lead to so-called touch voltage. The touch voltage is the voltage between a component (e.g. the down-conductor) and earth potential. The current flows from the hand to the foot through the body. The potential hazard must be reduced by technical measures, e.g. a control earther.

Note!

If a control earther or the insulation around the down-conductor is not possible, then barriers must be created or warning information attached.

Technical solution

The isCon® Pro+ conductor (5407995, 5407997) from OBO meets the requirements of VDE 0185 305-3 (IEC 62305-3) as a protective measure against dangerous touch voltages! It has been independently tested with a withstand voltage (-100 kV, 1.2/50 μs) under irrigation according to VDE 0432-1 (IEC/EN 60060-1).

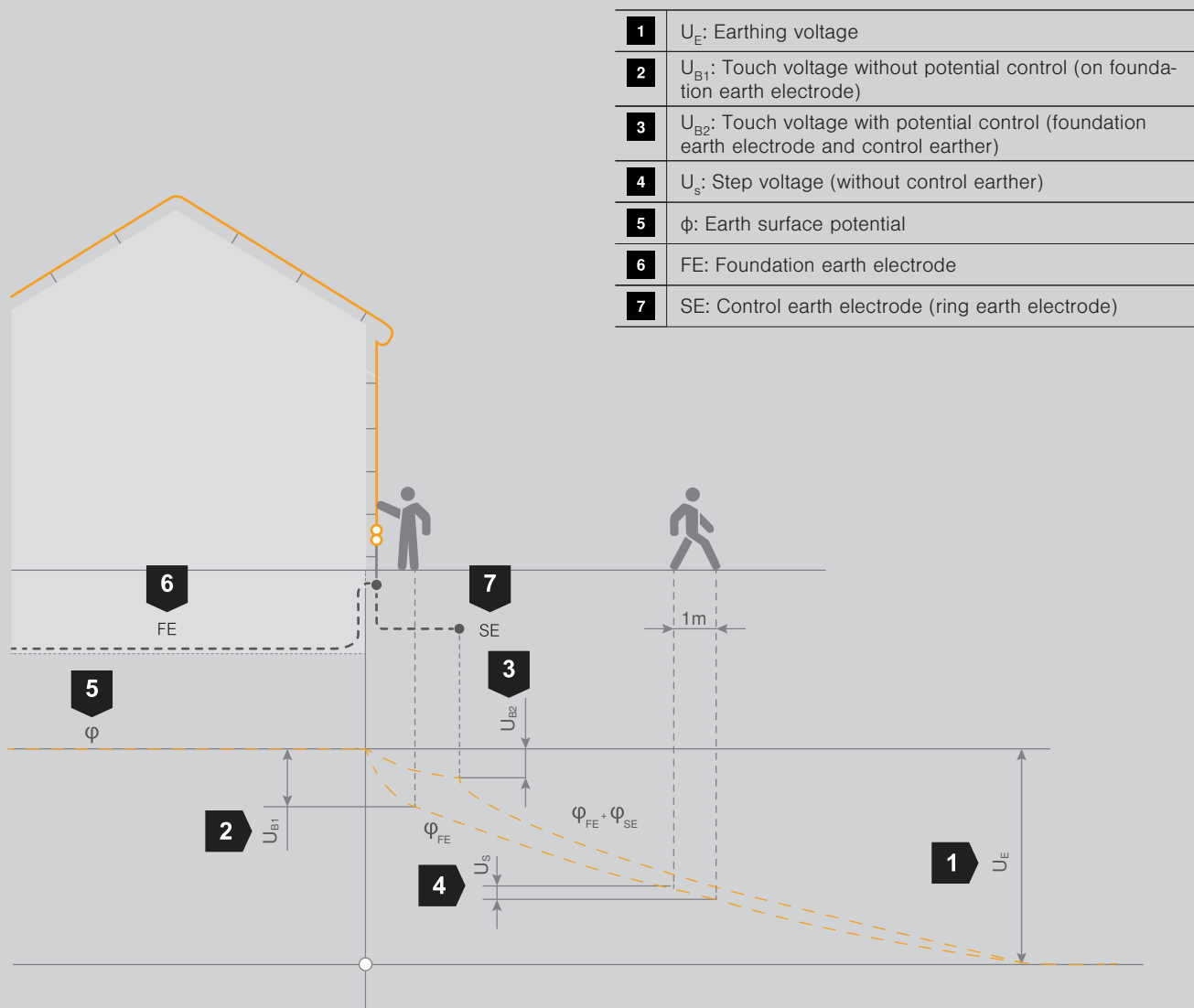

Electrical potential on the earth surface and voltages as current passes through the foundation earth electrode (FE) and control earther (SE)



Short-circuit current test on earth rod terminal



Short-circuit current test on earth rod

3.8 Short-circuit current carrying capacity of earthing components (50 Hz)

VDE 0101-2 (EN 50522) is the basis for considering the special requirements for earthing systems in heavy-current installations in networks with a rated AC voltage over 1 kV and a rated frequency up to 60 Hz. These types of earthing systems and all associated components must be planned and constructed in a way that controls the dangerous effects of a double earth short-circuit. If there are no particular specifications in the project, the duration of the residual current (switch-off time) of 1 second and the maximum permissible temperature of the components used in the earthing system of 300 °C are used as a basis.

OBO offers earth rods and connection components that have been tested for this purpose. The permissible 50 Hz short-circuit current density (G) for earthing materials for the duration of the residual current flow t_F can be taken from the diagram "Current carrying capacity of earthing materials".

The required cross-section of round earthers or earthing strips is calculated from the potential short-circuit current divided by the short-circuit current density. A detailed calculation, including conversion factors for additional max. final temperatures, such as 100 °C, 150 °C or 200 °C, is described in VDE 0101-2 (EN 50522).

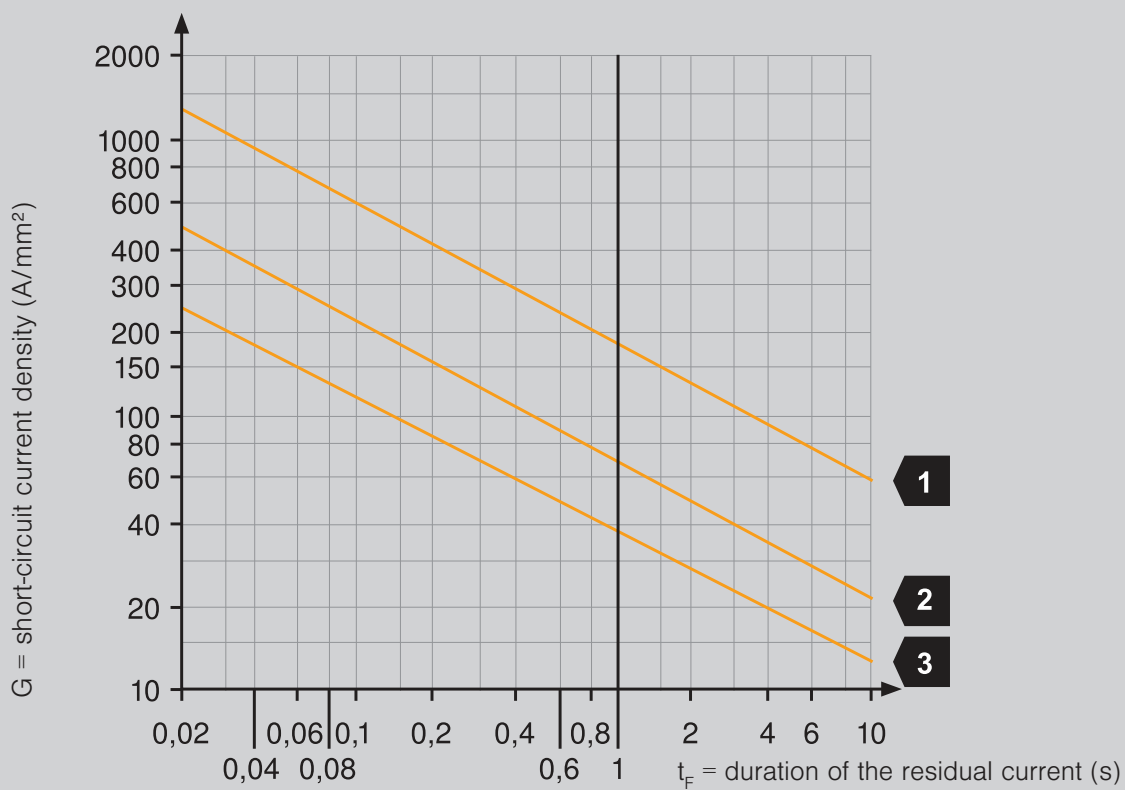

1	Copper
2	Galvanised steel
3	Stainless steel V4A (1.4404/1.457 1)

Current carrying capacity of earther materials

3.9 Antenna earthing according to VDE 0855-1 (EN/IEC 60728-11)

The earthing of the antenna system must be carried out according to VDE 0855-1 (EN/ IEC 60728-11), in one of the ways listed below:

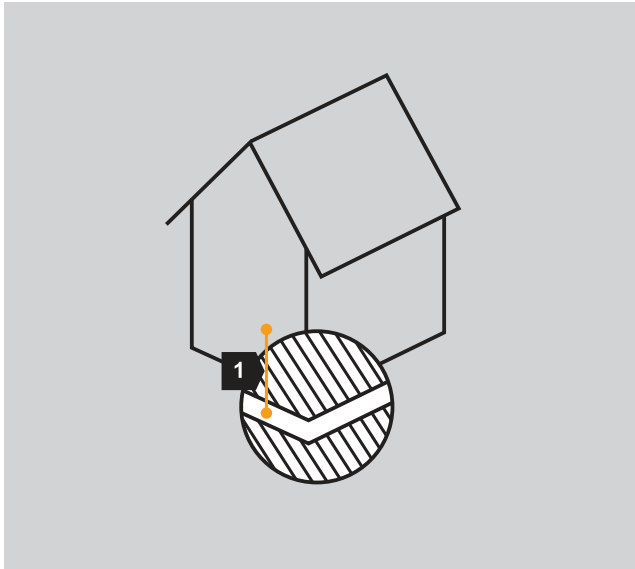

1. Connection with the earthing system of the building, e.g. with the foundation earth electrode

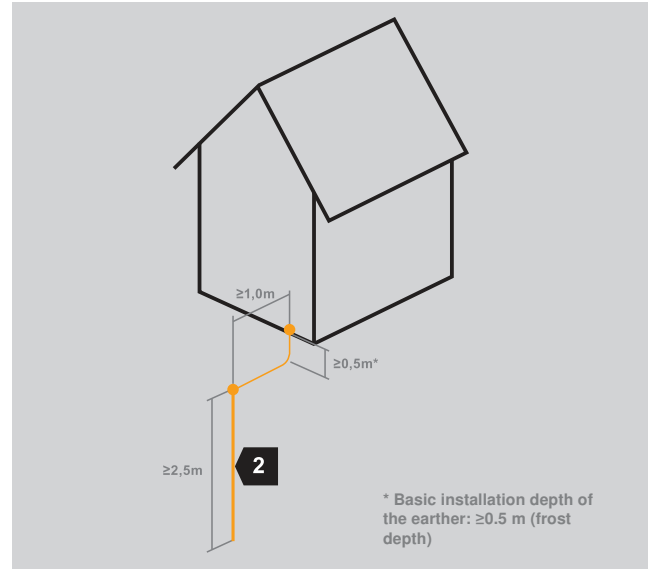

2. Connection with a vertical or slanted earth rod

- at least 2.5 m long
- at least 0.5 m deep in the ground
- at least 1 m away from foundation

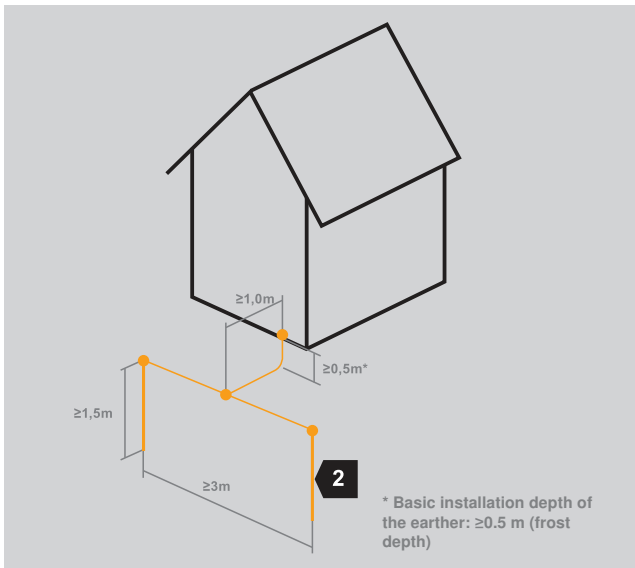

3. Connection with two vertical or slanted earth rods

- at least 1.5 m long each
- with at least 3 m distance between them
- at least 0.5 m deep in the ground
- at least 1 m away from the foundation

1	Foundation earth electrode
2	Earth rod

Earthing of antenna systems

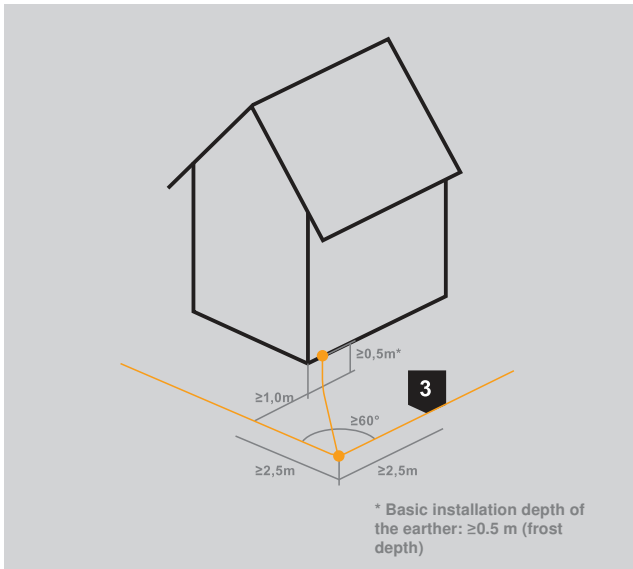

4. Connection with at least two horizontal earth rods

- at least 2.5 m long
- laid in an angle larger than 60°
- at least 0.5 m deep in the ground
- at least 1 m away from the foundation

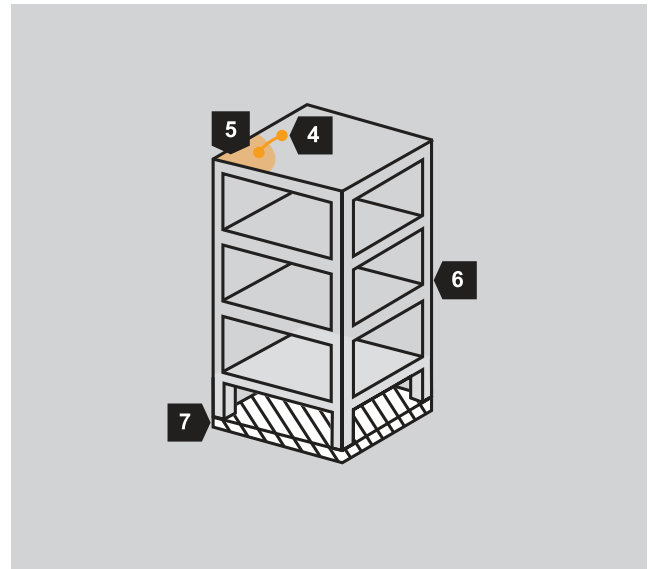

Natural component such as interconnected reinforced concrete (5) or metal constructions (6), such as curtain walls of suitable dimensions and material, when they are connected to the building foundation/earthing system (7).

3	Ring earther
4	Earthing fixed point
5	Reinforcement/steel construction
6	Steel skeleton/steel structures
7	Building foundation

Materials and dimensions

Suitable materials have a minimum cross-section of 50 mm² for copper or 90 mm² for stainless steel V4A. 90 mm² hot-galvanised steel may also be used, if the corrosion conditions in the ground permit.

Earthing of antenna systems

3.10 Earthing systems for wind power plants

The earthing system is the basis for the protection of people, fault-free operation of the electrical system and the basis of the lightning protection system. The main earthing rail creates the connection from the earthing system to the electrical resources and the components of the lightning and surge protection. If there is a lightning strike in the wind power plant (WPP), then the earthing system must distribute the currents into the earth at low impedance. VDE 0127-24 (IEC 61400-24) describes the lightning protection of wind power plants in detail. If there is a transformer station in the foot or immediate vicinity of the tower, then the possible short-circuit voltages should be taken into account.

The interconnected earthing systems of the tower and the transformer station may not exceed a value of 10 Ω. If this is exceeded, additional ring earthers or earth rods are required. In addition, the protection measures and switch-off conditions of the electrical system must be guaranteed.

Note!

In wind parks, each tower must possess its own earthing system, even if this is connected to the earthing system of the other towers, as is standard.

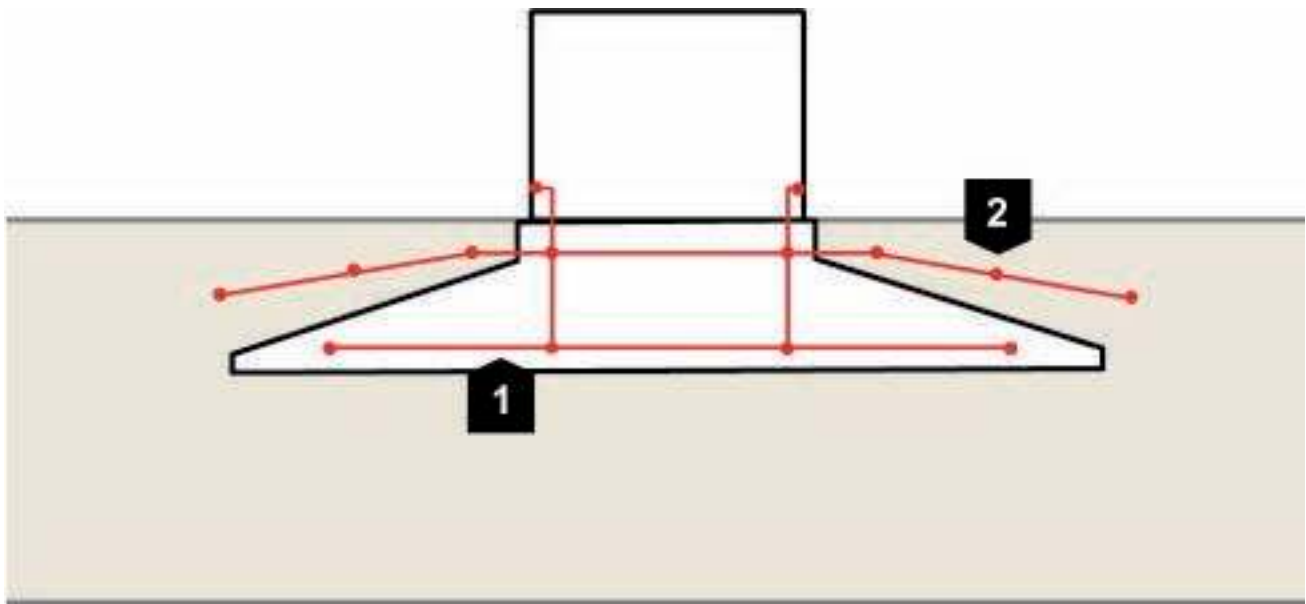

Foundation and ring earthers of a wind power plant

1	Foundation earth electrode
2	Ring earther



Earthing system of a wind power plant



Working on an earthing system of a wind power plant

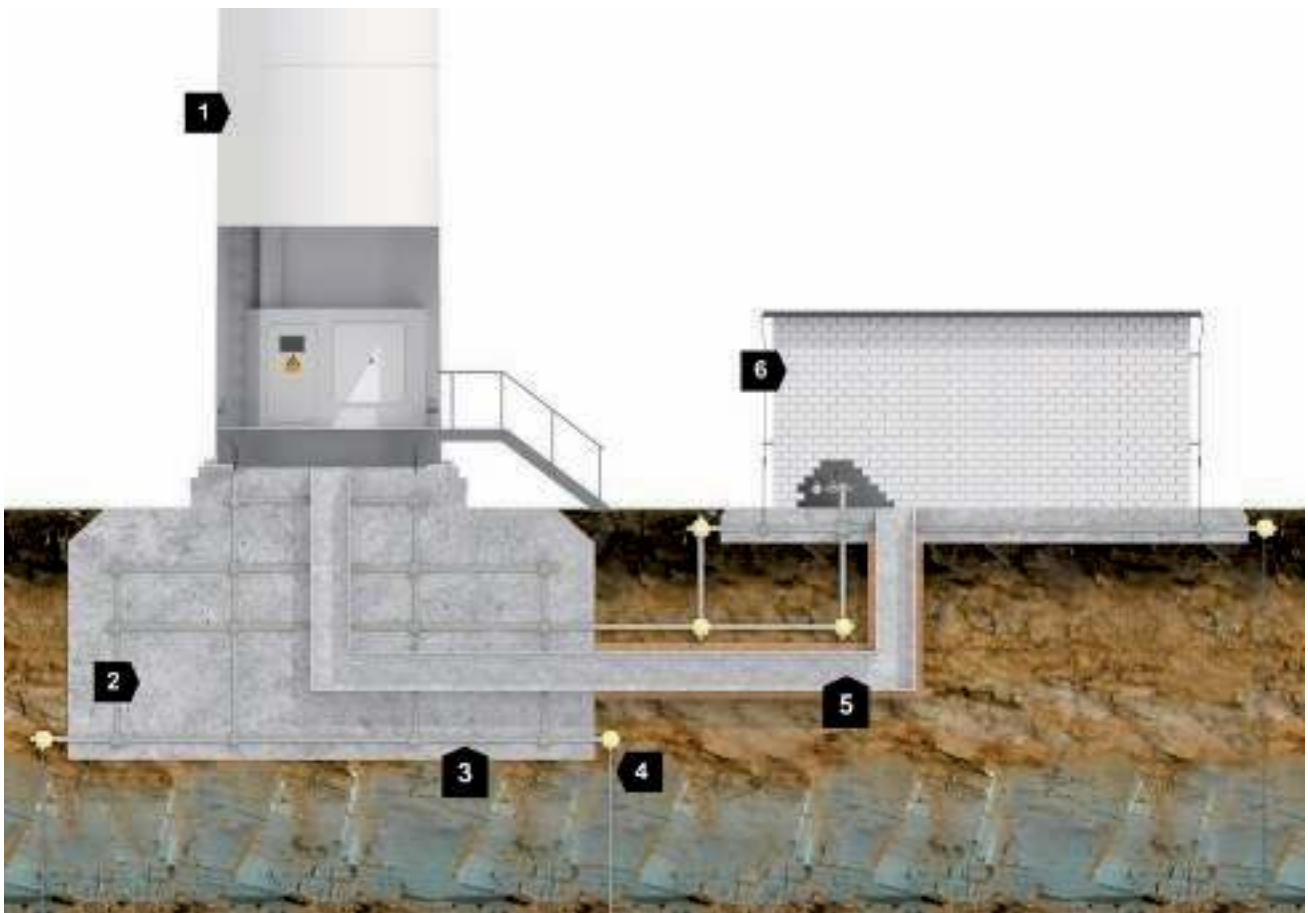

Earthing system of a wind power plant with additional buildings

1	Tower
2	Reinforced concrete foundation
3	Meshed earthing in concrete foundation
4	Earth rod and ring earther
5	Cable duct
6	Outbuilding

Hazardous step and touch voltages can be prevented by a ring earther which controls potential. Earthing systems in the earth must be in stainless steel quality V4A (1.4404/316L or 1.4571/316Ti). VDE 0127-24 (IEC 61400-24) provides information on this and refers to VDE 0140-479 (IEC 60479). According to the lightning protection standard for wind power plants VDE 0127-24 (IEC 616400-24), all metallic structures and installations of the WPP must be connected with the lightning protection equipotential bonding either directly or using suitable lightning conductors in accordance with VDE 0185-305 (EN 62305). The lightning protection standard VDE 0185-305-3 (IEC 62305-3) specifies earthers of type A and type B. For wind power plants (WPP), these arrangements are described as follows:

Earther, type A:

According to VDE 0127-24 (IEC 61400-24 Appendix I), the type A arrangement cannot be used for the earthing system of the WPP but only for additional buildings, housing offices or measuring technology, for example. The type A earthing system consists of horizontal and/or vertical earthers, which are connected to at least two down-conductors on the building.

Earther, type B:

According to VDE 0127-24 (IEC 61400-24 Appendix I), the type B arrangement must be used for the earther system of the WPP. This consists of a ring earther in the earth or an earthing system as a foundation earth electrode. The earthing system must be connected to the tower of the WPP. In addition, the earthing system of the tower and the existing operation building must be connected by a meshed earthing network. This earthing system, connected over a wide area, minimises potential differences.

Note!

To protect people and reduce step voltage, there must be additional potential control (ring earther) in the entrance area (see the chapter "Potential control against step voltages").

4. Documentation

The current foundation earth electrode standard DIN 18014 and also the safety standard for the erection of low-voltage systems DIN VDE 0100-600 (IEC 60364-6) require documentation. The documentation must contain the following elements:

- Plans and versions of the connection lugs
- Photos of the installed earthing system with detailed photographs
- Results of the continuity measurements
- Results of the measurements of the earthing resistances

Note!

There must be a continuity resistance value $\leq 0.2 \Omega$ between the connection parts. The resistance should be measured for the first time before concreting.

5. Conclusion

The earthing system is the basis for the entire electrical system. Together with the equipotential bonding system, a conductive and low-resistance connection to the local earth is created. Voltage differences between the connected parts are shorted and a reference potential is generated. The safety conditions and switch-off systems can only reach their protection aims when the system is implemented correctly. Besides correct planning, the installation must be checked and documented. The continued protective action of the earthing system must be ensured through regular maintenance and testing. Besides the state of the art and the named standards, the directives of the local power generating company must be complied with. A correctly installed earthing system, together with lightning and surge protection devices, can minimise damage and failures.

6. OBO selection aid for foundation and ring earthers according to DIN 18014 and IEC/EN 62305-3 (VDE 0185-305-3)

Foundation earth electrode – without lightning protection

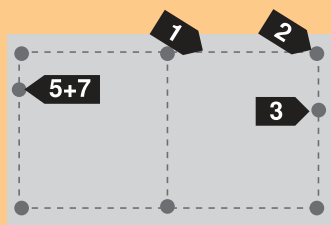

Functional equipotential bonding conductor and ring earther

Without lightning protection → Insulating foundation

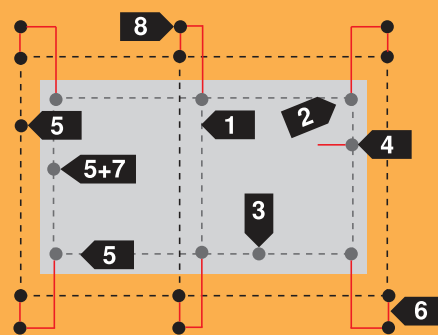

Functional equipotential bonding conductor and ring earther

With lightning protection → Insulating foundation

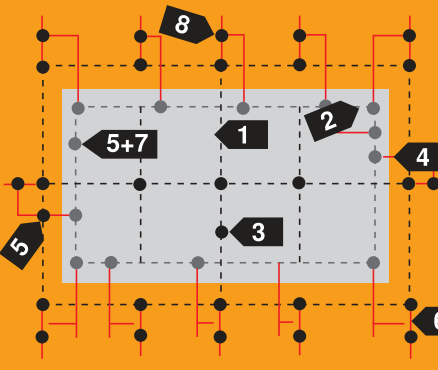

Earthing material, for use in concrete

- Surrounded by min. 5 cm of concrete on all sides; ≤ 2 m connect to reinforcement
- Grid width max. 20 x 20 m; with EMC protection to VDE 0185-305-4: 5 x 5 m
- Unreinforced foundation: Material no. 1.4571/1.4404, V4A

	Type	PU	Item no.	Description
1	5052	60 m	5019347	Strip steel 30 x 3.5 mm FT
	1811 I	25 units	5014026	Spacer 400 mm FT
2	250 A-FT	25 units	5313015	Connector, strip steel with reinforcement FT
3	1814 FT	25 units	5014468	Terminal on reinforcement to Ø 14 mm
	1814 FT D37	25 units	5014469	For reinforcements Ø 16–37 mm
4	205 B-M10 VA	25 units	5420008	Earthing fixed point M10
	DW RD 10	10 units	2360041	Sealing sleeve for round conductors 10 mm
	5011 VA M10	50 units	5334934	End piece for earthing fixed point M10
8	ProtectionBall	25 units	5018014	Protective cap for connection straps

Earthing and connection material, for use in the earth or cleanliness layer

- Material no. 1.4571/ 1.4404, V4A; clamps in earth with corrosion protection strip
- Min. 0.8 m deep, routing outside drainage shaft, frost apron (moist area)
- Grid: Without lightning protection: 20 x 20 m, connection between earth and concrete: Every 20 m, with lightning protection: 10 x 10 m, connection between earth and concrete: Every conductor

	Type	PU	Item no.	Description
5	RD 10 V4A	60 m	5021642	Round conductor Ø10 mm V4A
	5052 V4A 30x3.5	25 m	5018730	Strip steel 30 x 3.5 mm V4A
6	250 V4A	25 units	5312925	Terminal for round conductor and strip steel
	356	10 m	2360101	Corrosion protection strip, width: 100 mm

Material for equipotential bonding

	Type	PU	Item no.	Description
7	1801 VDE	1 unit	5015650	Equipotential busbar, industrial
	1809	1 unit	5015073	Equipotential busbar, residential

Foundation earth electrode:



Insulation foundation when:

- WU concrete (white trough) for WZ<0.6, from C30/B35, (from C25/B30) → Already possible
- Black/brown trough
- Completely enclosed foundation with perimeter insulation or dimpled membranes
- Additionally attached, capillary-breaking, poorly electrically conductive earth strata, e.g. made of recycling

Ring earther:



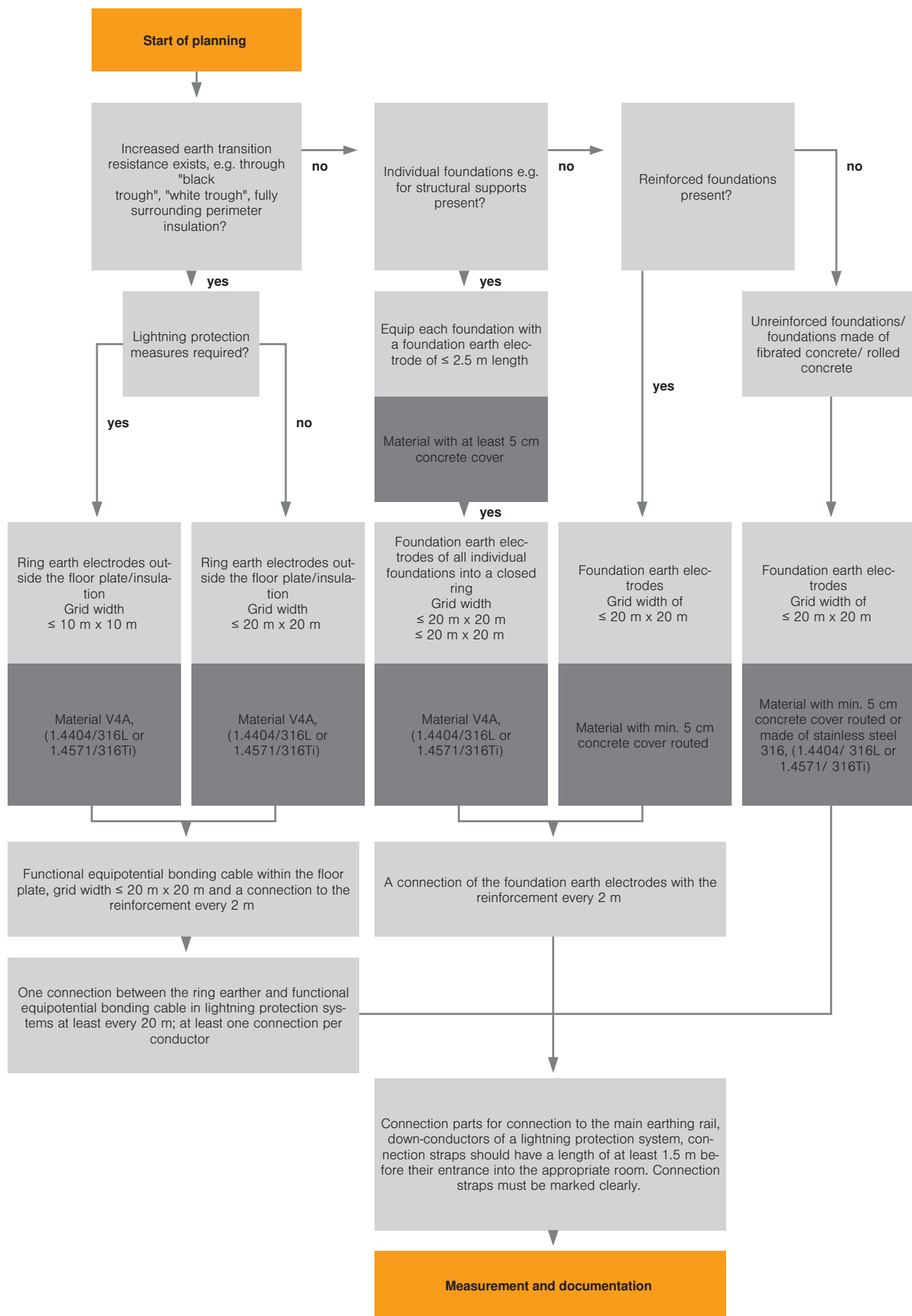

7. Literature notes

Lightning protection standard

- VDE 0185-305 (IEC 62305) Protection against lightning – Part 3: Protection of structural facilities and persons

Lightning protection components standard:

- VDE 0185-561-2 (IEC 62561-2 ed. 2) Lightning Protection System Components (LPSC) – Part 2: Requirements for conductors and earth electrodes

Low-voltage electrical installations

- VDE 0100 (IEC 60634) Low-voltage electrical installations
- VDE 0100-410 (IEC 60634-4-41) Low-voltage electrical installations – Part 4-41: Protection for safety – Protection against electric shock
- VDE 0100-534 (IEC 60634-5-534) Selection and erection of electrical equipment – Isolation, switching and control – Clause 534: Devices for protection against transient overvoltages (SPDs)
- VDE 0100-540 (IEC 60634-5-54) Selection and erection of electrical resources
- VDE 0800-2-310 (EN 50310) Earthing and equipotential bonding in buildings with information technology equipment
- DIN VDE 0100-600 (IEC 60364-6) Low-voltage electrical installations – Part 6: Verification

Earthing systems and protective conductors

- DIN 18014 Foundation earth electrode
- DIN 18015-1 Electrical installations in residential buildings

Antenna systems

- VDE 0855-1 (EN/IEC 60728-11) Cable networks for television signals, sound signals and interactive services – Part 11: Safety

Heavy-current installations

- VDE 0101-2 (EN 50522) Earthing of power installations exceeding 1 kV a.c.

Wind power plants

- VDE 0127-24 (IEC 61400-24) Lightning protection for wind power plants

Lightning protection guide

- OBO Bettermann ordering no. 9131970

Lightning protection guide. Safely routed.

Reference work and planning aid for electrical installation engineers and technical planners

At OBO Bettermann, we can look back on more than 90 years of experience in the field of lightning and surge protection. This experience and, of course, the latest standards and technical innovations have flowed into the company's new lightning protection guide. The brochure allows you to plan installations in the field of lightning and surge protection faster and more easily.

It contains a balanced mixture of both basic and expert knowledge, as well as planning and selection aids for the protection of buildings and systems.

The new lightning protection guide can be requested by calling +49 2373 89 - 1700 and is also available for download on the OBO website.



New in the 2nd edition

- Lightning and surge protection as part of fire protection
- New high-voltage-resistant, insulation isCon® conductors and selection aid
- Lightning protection in potentially explosive areas
- Protection angle calculation and protection rating recommendation
- Formation of equipotential areas
- Combination arrester type 1+2 in mains-side connection compartment
- Definition of construction material classes according to EN 13501-1
- Explanations of DIN VDE 0100-443 and -534

OBO Bettermann Holding GmbH & Co. KG
P.O. Box 1120
58694 Menden
GERMANY

Customer Service
Tel.: +49 (0)23 73 89 - 17 00
Fax: +49 (0)23 73 89 - 12 38
export@obo.de

www.obo-bettermann.com

Building Connections

