

Guide to Low Voltage Circuit-Breakers Standards

In accordance with BS EN 60898-1,
BS EN 60898-2 and BS EN 60947-2



BEAMA Guide to Low Voltage Circuit-breakers Standards in accordance with BS EN 60898-1, BS EN 60898-2 and BS EN 60947-2

Companies involved in the preparation of this Guide



BEAMA would like to thank IEC and BSI for allowing reference to their standards.

Contents

INTRODUCTION	4
ABBREVIATIONS AND DEFINITIONS	5
1. Standards	6
1.1. Low voltage circuit-breaker standards	6
1.2. United Kingdom Standards	7
2. Types of Circuit-Breaker	9
2.1. Miniature circuit-breakers	9
2.2. Moulded Case circuit-breakers	9
2.3. Air circuit-breakers	10
3. Low voltage circuit-breakers for use in household and similar installations	11
3.1 History of the development of BS EN 60898	11
3.2. BS EN 60898 Characteristics	11
3.3. BS EN 60898 Time/Current Characteristics	12
3.4. BS EN 60898 Rated values	13
3.5 Installation Factors	17
4. Low voltage circuit-breakers for use in industrial and similar installations	21
4.1 History of the development of BS EN 60947-2	21
4.2. BS EN 60947-2 Characteristics	22
4.3 BS EN 60947-2 Rated Values	23
4.4 Installation Factors	27
4.5 Determination of maximum earth Loop impedance (Z_s)	27
4.6. Harmonic currents	28
5. Technical And Application Data – all Low Voltage Circuit-breakers to BS EN 60898-1, BS EN 60898-2 and BS EN 60947-2	30
5.1. Circuit-breaker substitution in assemblies	30
5.2. Functional switching with Circuit-breakers	30
5.3. Coordination of Low-voltage Switchgear and Controlgear assemblies with conductors operating at a temperature exceeding 70°C e.g. XLPE	31
5.4. Overcurrent coordination of devices from different manufacturers	31
Companies involved in the preparation of this Guide	34



BEAMA Guide to Low Voltage Circuit-Breakers in accordance with BS EN 60898-1, BS EN 60898-2 and BS EN 60947-2

Introduction

This guide is intended as a practical guide for designers, specifiers and installers to enable them to specify low voltage circuit-breakers in accordance with BS EN 60898-1, BS EN 60898-2 and BS EN 60947-2.

This guide should be read in conjunction with these standards as it provides additional explanation on each section.

This guide has been produced by BEAMA's Industrial & Single Phase Product Group, and explains the characteristics of low voltage circuit-breakers for use in industrial and household and similar installations, which fall within the wide scope of BEAMA's Industrial & Single Phase Product Group.

BEAMA's Industrial & Single Phase Product Group comprises major UK manufacturing companies in this field and has its own officers, technical and other committees, all operating under the guidance and authority of BEAMA, supported by specialist central services for guidance on European Single Market, Quality Assurance, Legal and Health & Safety matters.

Active participation in the work of numerous national, international and regional standards committees has provided the background and support to ensure safety and performance for the design, development and manufacture of its members' products. The result is quality equipment of the highest standard throughout each group of the association.

BEAMA's Industrial & Single Phase Product Group is part of BEAMA's Installation sector, well known for its authoritative industry Guides. Details of other BEAMA Installation Sector guides can be found on the BEAMA website.

www.beama.org.uk

BEAMA is the long established and respected trade association for the electrotechnical sector. The association has a strong track record in the development and implementation of standards, safety and product performance for the benefit of manufacturers and their customers.

DISCLAIMER

This publication is subject to the copyright of BEAMA Ltd. While the information herein has been compiled in good faith, no warranty is given or should be implied for its use and BEAMA hereby disclaims any liability that may arise from its use to the fullest extent permitted under applicable law.

© BEAMA Ltd 2014

Copyright and all other intellectual property rights in this document are the property of BEAMA Ltd. Any party wishing to copy, reproduce or transmit this document or the information contained within it in any form, whether paper, electronic or otherwise should contact BEAMA Ltd to seek permission to do so.

Abbreviations and Definitions

ACB	Air circuit-breaker. A circuit-breaker in which the contacts open and close in air at atmospheric pressure. The term is conventionally applied to high current rated circuit-breakers ($\geq 800\text{A}$). Also referred to as 'power-breakers'.
CENELEC	The body responsible for standards in affiliated countries in Europe.
IEC	International Electrotechnical Commission – the body responsible for standards in member countries world-wide.
LVD	Low-voltage Directive – European directive giving the essential safety requirements for low-voltage equipment.
MCB	Miniature circuit-breaker.
MCCB	Moulded Case circuit-breaker.
r.m.s.	Effective value of an alternating current (heating effect). Mathematically derived from the square root of the mean squares of the instantaneous values.
RCBO	Residual-current circuit-breaker incorporating overcurrent protection.
SCPD	Short-circuit protective device intended to protect a circuit or parts of a circuit against short-circuit currents by interrupting them.

I. Standards

I.1 Low Voltage Circuit-Breaker Standards

I.1.1. Harmonisation

In an ideal world, the compatibility of manufactured goods across a wide geographical area can remove barriers to trade and can result in an efficiency of scale due to increased manufacturing volumes which in turn can reduce costs. In the electrical industry, appropriate standardisation could mean common supply networks and products; and in low-voltage circuit-breaker applications can result in:

- ability to use compatible equipment;
- no need to adapt or modify such products;
- fewer limitations on the source of supply.

To this end considerable progress has already been made by the national standards committees of over 80 nations who are co-operating to formulate world standards which provide a consensus of international opinion on electrical supply and harmonisation.

I.1.2. World Standards

Participating countries comprise the International Electrotechnical Commission (IEC).

Most of these participating countries already have their own national standards which may differ from elements of the IEC Standards. However when a need for harmonisation is identified, documents produced by the IEC may, where appropriate, form the basis for future national standards.

I.1.3. European Standards

Within Europe harmonisation of electrical products is controlled by CENELEC (Comite Européenne de Normalisation Electrotechnique) which produces appropriate European standards generally based on the work of the IEC, once a need has been identified and agreed.

CENELEC is made up of over 30 national standards committees of the European Union and EFTA (European Free Trade Association). Whilst a European Standard can be a direct replica of an IEC standard, discussions within CENELEC may result in the formulation of a standard which includes commonly agreed variations.

Two types of publication exist: the European Norm (prefixed EN-) and the Harmonised Document (prefixed HD-) where EN- qualifies the adoption of the standard by all member countries *without* deviation; and HD- a document that does not have to be adopted as a national standard but no conflicting national standards must exist.

The European Norm, within its scope, covers all the relevant essential requirements as given in Article 4 of the LVD (Low-voltage directive). This means that circuit-breakers complying with the standards quoted in this Guide comply with the essential requirements of the LVD and the CE mark must be applied.

The numbering of an EN- or HD- indicates the presence or otherwise of an IEC Standard. The 6xxxx series indicates that a EN or HD is based on a published IEC document whilst 5xxxx series indicates that the EN or HD originated in Europe and there is no published IEC equivalent document.

1.2. United Kingdom Standards

Adoption of the European Standard (EN) within the EU is mandatory. In the UK such standards are further endorsed with the additional 'BS' prefix, for example: BS EN 60898, the British Standard for circuit-breakers for overcurrent protection for household and similar installations.

BS EN 60898-1 (EN 60898-1, IEC 60898-1) & BS EN 60898-2 (EN 60898-2, IEC 60898-2) relate to low-voltage circuit-breakers for use in household and similar installations. In the UK these are traditionally known as miniature circuit-breakers or (MCB's).



Household



Retail



Schools



Offices

BS EN 60947-2 (EN 60947-2, IEC 60947-2) relate to low-voltage circuit-breakers for use in industrial and similar installations. In the UK these are traditionally known as moulded case circuit-breakers (MCCB's) or air circuit-breakers (ACB's) according to the construction.



Car Assembly



Petrochemical

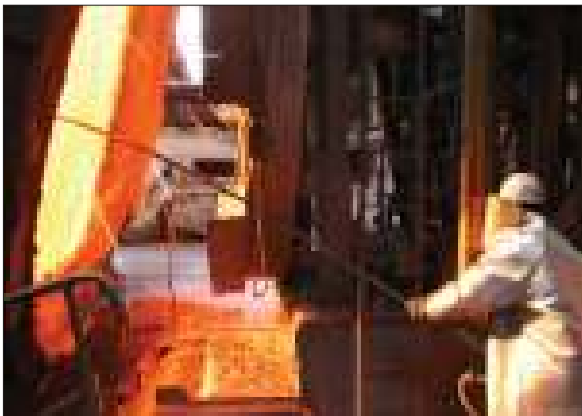

Steel Production



Food Processing

2. Types of Circuit-breaker

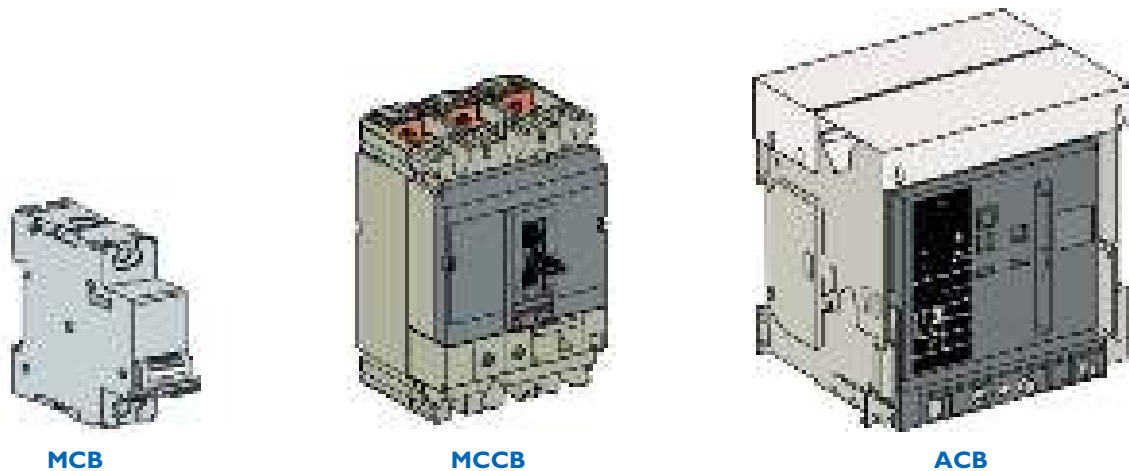

2.1. Miniature Circuit-breakers

(MCBs) to BS EN 60898 are suitable for operation by ordinary persons and have fixed protection settings, generally a two position on/off operating handle and a performance relative to the final circuits in an electrical installation. They would normally be the final overcurrent protection measure in the electrical system, for example before sockets or lighting circuits.

Typical current ratings are from 0.5 A to 125 A. Short-circuit ratings may be up to 25 kA. Performance and testing is in accordance with BS EN 60898 for domestic and similar applications categorised by the trip characteristic types B, C & D. MCBs may also be available with application specific tripping characteristics.

MCBs may also be rated in accordance with BS EN 60947-2 for industrial or similar applications

2.2. Moulded Case Circuit-breakers

(MCCBs) may have fixed or adjustable protection settings, normally a three position toggle operating handle giving on-off-tripped indication plus reset function, and a performance level relative to the incoming supply such that they can be installed at a point close to the supply transformer.

Typical current ratings are from 16 A to 1600 A though ratings up to 3,200 A are available. Short-circuit ratings may be up to 100 kA. Performance and testing is in accordance with BS EN 60947-2.

2.3. Air Circuit-breakers

(ACBs) are normally used as the main incoming protection and have a spring-operated mechanism to open and close the device often charged by an internal motor. The protection settings will include time delays and the devices will have a short-time withstand value to give full discrimination under fault conditions with downstream protection devices.

Typical current ratings are 630 to 6,300 A. Short-circuit ratings may be up to 150 kA. Performance and testing is in accordance with BS EN 60947-2.

3. Low Voltage Circuit-Breakers for use in Household and Similar Installations

3.1. History of the development of 60898

BS EN 60898-1, BS EN 60898-2 (EN 60898-1, EN 60898-2, IEC 60898-1 IEC 60898-2)

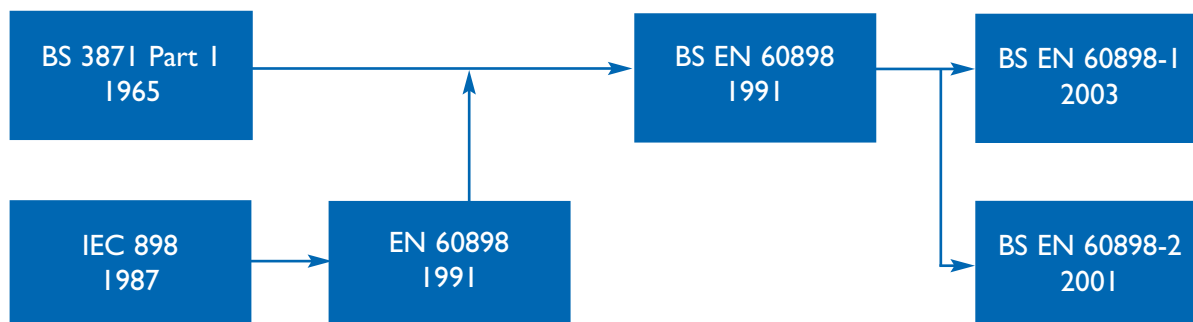

It can be seen from the diagram above that up to 1987 no IEC Standard existed for miniature circuit-breakers that, in the UK, had been manufactured since 1965 to BS 3871, under the title ‘Miniature Air Circuit-breakers for a.c. circuits.’

The introduction in 1987 of IEC 898, under the title ‘Circuit-breakers for Overcurrent Protection for Household and Similar Installations’, formed the basis for acceptance of the European Standard EN 60898; which was published in the UK in 1991, as BS EN 60898. BS 3871 Part I was withdrawn on the 1st July 1994.

Products that complied with BS 3871 Part I before 1st July 1994, as shown by the manufacturer, were allowed to apply for production until 30th June 1999. Since this date all products should comply with BS EN 60898.

BS EN 60898 was further developed into parts 1 and 2. BS EN 60898-1 gives the requirements for circuit-breakers rated for a.c. only and BS EN 60898-2 gives the requirements for circuit-breakers rated for both a.c and d.c.

3.2. BS EN 60898 Characteristics

3.2.1. Preferred values of current

The preferred values are 6, 8, 10, 13, 16, 20, 25, 32, 40, 50, 63, 80, 100 and 125 A.

3.2.2. Isolation

Circuit-breakers conforming to BS EN 60898 are suitable for isolation. However, miniature circuit-breakers (MCBs) manufactured to earlier standards (such as BS 3871) are unlikely to be suitable for isolation.

3.3 BS EN 60898 Time/Current Characteristics

3.3.1. Instantaneous Trip Setting Type to BS EN 60898

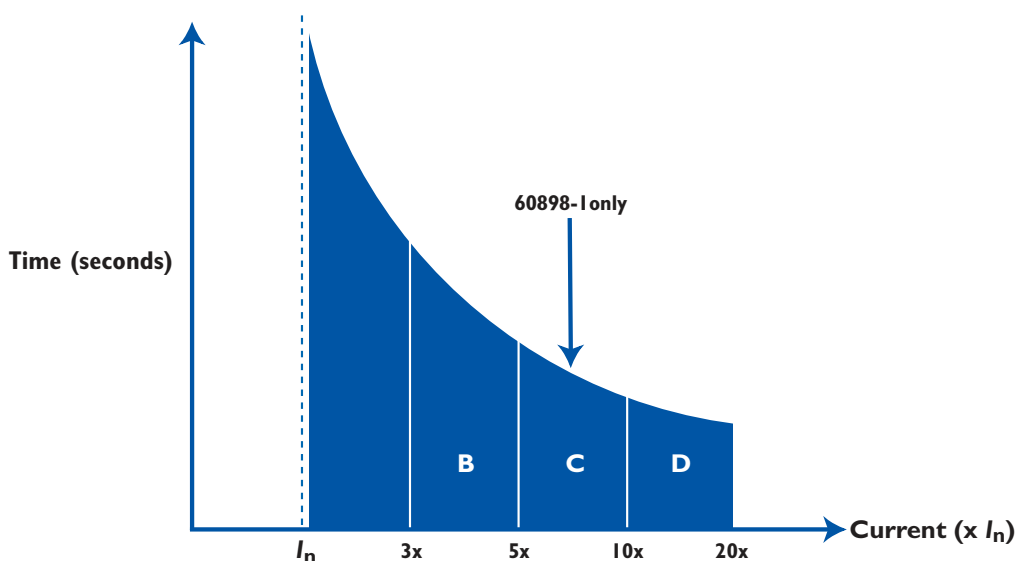

Trip Type	Range of instantaneous Trip (< 0.1 s)	Load Type	Typical Load (see manufacturer's data for application)
BS EN 60898-1 Range			
B	3 to 5 I_n	Resistive	Heaters, showers, cookers, socket outlets.
C	5 to 10 I_n	Inductive	Motors, general lighting circuits, power supplies.
D	10 to 20 I_n	High Inductive	Transformers, motors, discharge lighting circuits, computers.
<i>Note: There is no Type A instantaneous tripping characteristic to avoid confusion with the A abbreviation for amperes.</i>			
BS EN 60898-2 Range			
B	3 to 5 I_n (a.c) 4 to 7 I_n (d.c)	Resistive	Heaters, showers, cookers, socket outlets. Rail, photovoltaic.
C	5 to 10 I_n (a.c) 7 to 15 I_n (d.c)	Inductive	Motors, general lighting circuits, power supplies. Rail, photovoltaic.
BS 3871 Range (Superseded)			
1	2.7 to 4 I_n	Resistive	Domestic, Heaters, Showers, Cookers, general socket outlets
2	4 to 7 I_n	Resistive/Inductive	Small inductive switching loads, lighting and domestic circuits
3	7 to 10 I_n	Inductive	Motors, general lighting circuits, power supplies.
4	10 to 50 I_n	High Inductive	Transformers, motors, discharge lighting circuits, computers

3.4. BS EN 60898 – Rated Values

3.4.1. U_e Rated operational voltage.

The nominal voltage of the system should not exceed U_e .

Example: Single Pole $U_e = 230/400$ V and for Three Pole $U_e = 400$ V

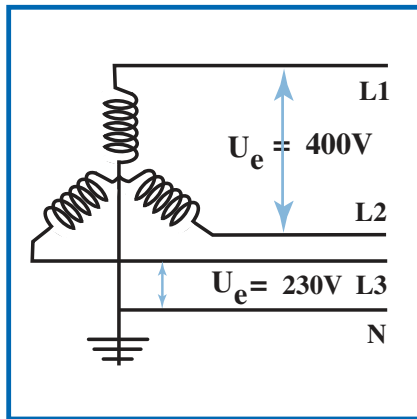

3.4.2. U_i Rated Insulation Voltage

This is the voltage on which the dielectric properties are based using tests at high voltage and mains frequency.

Example: $U_i = 500$ V, test voltage = 2000 V

Unless otherwise stated the rated insulation voltage is the value of the maximum rated operational voltage of the circuit-breaker. In no case shall the maximum rated operational voltage exceed the rated insulation voltage.

3.4.3. U_{imp} Rated Impulse Withstand Voltage

This is the voltage on which clearance distances are based. This is a voltage impulse with a 1.2/50 μ s wave shape, see figure below.

Example: $U_{imp} = 4$ kV for 230/400V rated MCBs

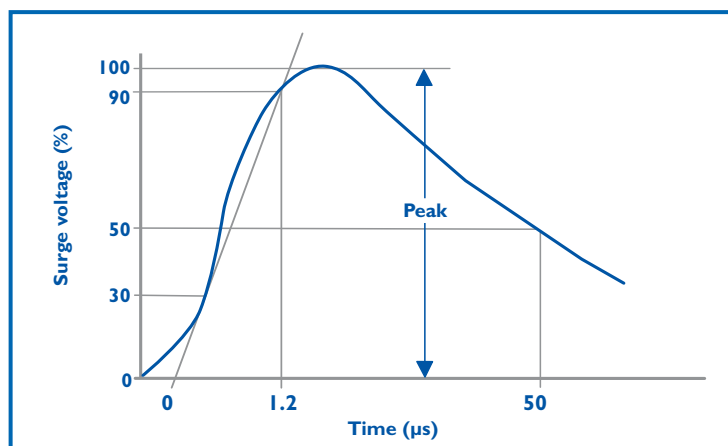

3.4.4. I_n Rated Current

The current that the circuit-breaker will carry continuously under specified conditions and on which the time/current characteristics are based.

Unless otherwise stated I_n is based on a reference ambient temperature of 30°C.

Example $I_n = 32A$ rating, type C marked 'C32'.

3.4.5 I_{cn} Rated Short-Circuit Capacity

The manufacturer must declare the short-circuit capacity of the circuit-breaker. The preferred short-circuit capacities up to 25 kA are recognised with the following values of I_{cn} see table below.

The short-circuit capacity according to BS 3871, now superseded, was expressed as an 'M' value, see table below.

Preferred rated short-circuit capacity I_{cn}

BS EN 60898	
Marking	I_{cn} Amperes
1500	1500
3000	3000
4500	4500
6000	6000
10000	10000
15000	15000
20000	20000
25000	25000

Short-circuit capacity according to BS 3871

BS 3871 (Superseded)	
M1	1000 A
M1.5	1500 A
M3	3000 A
M4.5	4500 A
M6	6000 A
M9	9000 A

The prospective fault current at the incoming terminals of the circuit-breaker should not exceed I_{cn} except that the prospective fault current may exceed I_{cn} when co-ordinated with another short-circuit protective device as specified by the manufacturer.

In order to define the value of I_{cn} the circuit-breakers under test must be subjected to a test sequence of:

$$I_{cn} = O - t - CO$$

Where:

- O = opening operation under fault conditions.
- t = time interval before re-closing (3 minutes.)
- CO = closing operation on to a fault.

After this test sequence, leakage current, dielectric and overcurrent release tests are applied.

3.4.6. I_{cs} Service Short-Circuit Capacity [Not marked on the circuit-breaker]

In order to define the value of I_{cs} the circuit-breakers under test must be subjected to a test sequence of three short-circuit operations:

$$I_{cs} = O - t - CO - t - CO$$

Where:

- O = opening operation under fault conditions.
- t = time interval before re-closing (3 minutes)
- CO = closing operation on to a fault.

After this test sequence, leakage current, dielectric, and time/current characteristics tests are applied. The circuit-breaker must meet certain test parameters to ensure that the circuit-breaker has not deteriorated in performance and can, in fact, be put back into service.

Ratio (K) between service short-circuit capacity (I_{cs}) and rated short-circuit capacity (I_{cn})

I_{cn}	K
≤ 6000	1
$> 6000 < 10000$	0.75 ¹
> 10000	0.5 ²
¹ Minimum value of I_{cs} 6000 A	
² Minimum value of I_{cs} 7500 A	

3.4.7. Energy-Limiting Classes

Circuit-breakers to BS EN 60898 of B-type and C-type, having rated current up to and including 63 A and a rated short-circuit capacity of 3 000 A, 4 500 A, 6 000 A and 10 000 A, are classified according to the limits within which their I^2t characteristics lie. I^2t is a measure of the energy let-through by the circuit-breaker under short-circuit conditions.

This classification is indicated on the circuit-breaker as shown below.



Circuit-breakers are classified into energy limiting classes in order to help the project engineer and installer to obtain selectivity with devices on the supply side and determine cable protection in the case of a fault current (short-circuit).

3.4.8. Permissible I^2t (let-through energy) in A^2s for circuit-breakers type B with rated current up to and including 63A

	Type B				
Rated short-circuit capacity A	Class 1	Class 3			
	≤ 63A	≤ 16A	20 A 25 A 32 A	40 A	50A 63A
3 000	No limits specified	15 000	18 000	21 600	28 000
4 000		25 000	32 000	38 400	48 000
6 000		35 000	45 000	54 000	65 000
10 000		70 000	90 000	108 000	135 000

3.4.9. Permissible I^2t (let-through energy) in A^{2s} for circuit-breakers type C with rated current up to and including 63A

	Type C				
Rated short-circuit capacity A	Class 1	Class 3			
	≤ 63A	≤ 16A	20 A 25 A 32 A	40 A	50A 63A
3 000	No limits specified	17 000	20 000	24 000	30 000
4 500		28 000	37 000	45 000	55 000
6 000		40 000	52 000	63 000	75 000
10 000		80 000	100 000	120 000	145 000

The maximum let through energy values are given in the tables above. The manufacturer may publish data giving actual let-through energy values which may be lower than the maximum values.

Let-through energy characteristics for all other circuit-breakers including Type D and Class 1 are available from the manufacturer.

3.5 Installation Factors

3.5.1. Application of an RCBO to BS EN 61009

An RCBO will have overcurrent characteristics as for the equivalent MCB (see above) and also a residual current characteristic.

In this case the maximum earth loop impedance Z_s is determined according to the residual current characteristic and is given in BS 7671 regulation 411.4.9 and Table 41.5.

The selection of the type of overcurrent characteristic (B, C or D) is made as for the equivalent MCB, according to the application.

3.5.2. Protection against electric shock – Automatic disconnection in case of a fault – determination of maximum earth-loop impedance (Z_s)

The maximum value of earth fault loop impedance may be found in the IET Wiring Regulations (BS 7671) for Type B, C and D circuit-breakers, or from details published by the manufacturer.

For superseded BS 3871 (Types 1, 2, 3 and 4) the maximum value of earth fault loop impedance may be calculated using the formula in the regulations BS 7671 and the manufacturer's tripping characteristic.

Where the requirements cannot be achieved using an overcurrent protective device (OCPD) alone, the use of a residual current device may be used to provide protection against shock due to an earth fault condition. This can be achieved using a device complying with BS EN 61008 or BS EN 61009. At the design stage of the installation, the earth fault loop impedance (Z_s) and the load characteristic may determine the type of circuit-breaker used.

3.5.3. Fault current (short-circuit) protection of cables

The application of fault current protective devices to cable protection is detailed in BS 7671 and is given by:

$$I^2t \leq k^2S^2$$

Where:

I^2t is the energy let-through value of the protective device

k^2S^2 is the energy withstand of the cable

3.5.4. Back-up protection – general

BS 7671 permits the breaking capacity of a circuit-breaker to be less than its associated prospective fault current when back-up protection is employed. Back-up is also referred to as cascading. Back-up protection consists of an upstream short-circuit protective device (SCPD) that helps a downstream circuit-breaker to break fault currents greater than its maximum breaking current (I_{cn} for an MCB), which in effect is a conditional rating, see Figure A below.

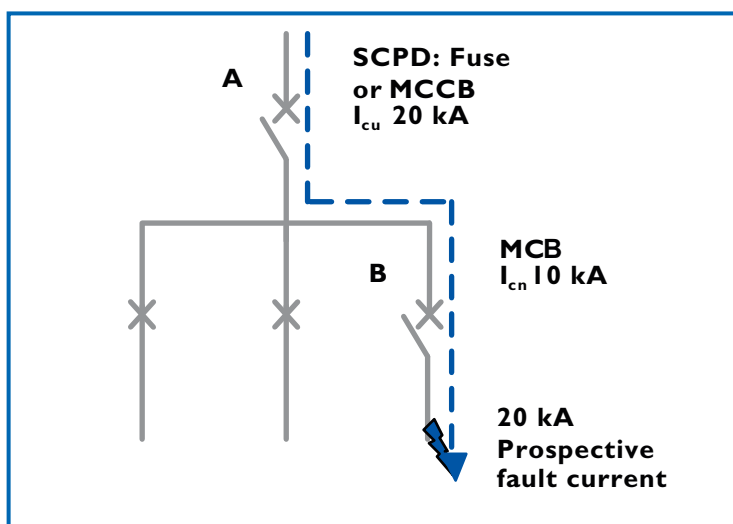

Figure A.
Example
of backup
protection

Circuit-breaker product standards prescribe back-up protection requirements, which can only accurately be verified by test. The energy let-through (I^2t) of the back-up combination, when required, must be derived from testing and obtained from the manufacturer.

3.5.5. Back-up protection methodology

Desk top studies frequently indicate that back-up coordination requires the upstream SCPD to independently limit the energy let-through and peak current, to values that can be withstood by the downstream SCPD, assuming that the downstream SCPD makes no contribution to the fault interruption process. This approach errs on the side of caution in relation to device coordination and cable protection studies.

However, where an MCCB, MCB or fuse is the upstream SCPD, and the downstream SCPD is an MCB, coordination tests can be used to validate that the I^2t of the specific combination will not exceed the I^2t value of the downstream MCB at its maximum breaking capacity.

This reduction in the energy let-through is a result of having two protective devices interrupting the fault current and thus creating superior current limitation and arc extinction than the individual upstream SCPD “A” alone, this is illustrated in Figure B below.

Back-up protection can also be achieved by coordinating the upstream circuit-breaker contacts to separate momentarily with the downstream circuit-breaker. This arrangement allows the upstream device to return to the closed position, having assisted the downstream circuit-breaker to interrupt the fault current.

3.5.6. Consumer Unit fuse conditional rating

Fuse back-up protection to 16 kA is a mandatory test for protective devices in Consumer Units complying with BS EN 61439-3 Annex ZB (previously BS EN 60439-3 Annex ZA.) This is a conditional rating, as the conditions specifically relate to the use of an upstream BS 88-3 (formerly BS 1361) 100 A fuse.

3.5.7. Cable protection in the case of back-up protection

In Figure B below the I^2t of the upstream SCPD “A” and downstream MCB “B” operating together at 20 kA, will be equal to or less than the I^2t of MCB “B” at 10 kA. The I^2t to be used in the conductor fault current assessment would be that of MCB “B” at 10 kA. This combination has to be confirmed by the manufacturer, together with the maximum prospective fault current applicable.

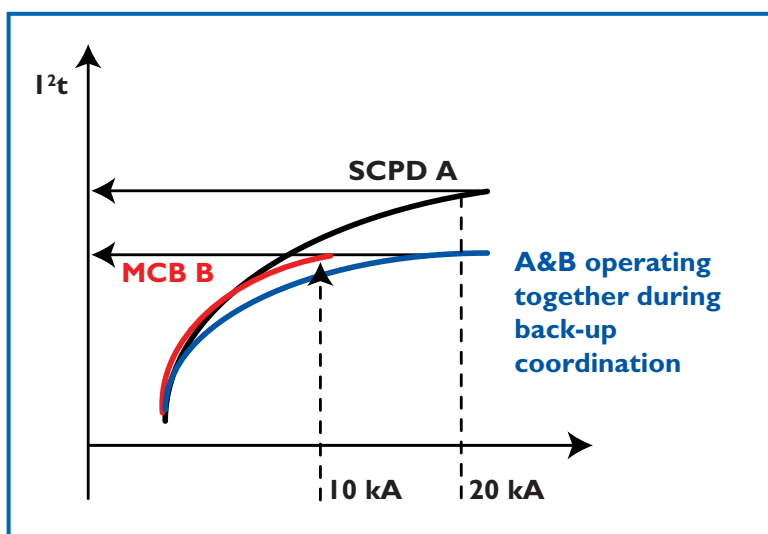

Figure B.
Example of I^2t

3.5.8. Low voltage switchgear and controlgear assemblies

The assembly manufacturer is responsible for ensuring the short-circuit capability of the equipment between the incoming and outgoing terminals of the assembly (incoming and outgoing devices, busbars, connections, etc.). The short-circuit rating is determined in accordance with the applicable product standard and stated by the manufacturer.

LV assemblies are known as: Consumer Units, Distribution Boards, Panelboards and Switchboards.

3.5.9. Harmonic currents

Harmonic currents are those in which the nature of the load distorts the current waveform, generally due to electronic control of the current e.g. electronic ballasts in lighting; power supplies in computers.

Harmonics are expressed as a multiple of the mains frequency (50Hz in the UK) e.g. the 3rd harmonic has a frequency of $3 \times 50 = 150$ Hz.

There are two factors to be considered relative to circuit-breakers:-

3.5.9.1. Overload protection

Circuit-breakers with bimetallic thermal overload protection use a trip release that responds to the heating effect of the overload current i.e. they respond to the true RMS value of the current waveform. This type of circuit-breaker will provide protection to the circuit conductors in the case of overload currents including harmonics.

3.5.9.2. Neutral currents

3.5.9.2.1.

Third harmonics and their multiples in a 3-phase system accumulate in the neutral conductor, even when the load currents in the phases are balanced. This needs to be allowed for in the sizing of the neutral in equipment and conductors.

3.5.9.2.2.

BS 7671:2008 (2015) states “If the total harmonic distortion due to third harmonic currents or multiples of the third harmonic is greater than 15% of the fundamental line current the neutral conductor shall not be smaller than the line conductors”. In the case of significant neutral currents due to harmonics a 4-pole circuit-breaker with a protected neutral pole may be required to protect the neutral conductor.

3.6. Further technical and application information, common to all LV circuit-breakers, is given in section 5.

4. Low Voltage-Circuit-Breakers for use in Industrial and Similar Installations

4.1. History of the development of 60947-2

BS EN 60947-2 (EN 60947-2, IEC 60947-2)

To fully understand the scope of IEC 60947-2, one must refer back to the origins of circuit-breaker standards. The original standard in the UK was BS 3871 Part 2 1966, which was followed by the evolution of IEC 157 Part 1 1973. This was incorporated as BS 4752 in 1977. During the 1980's the concept of the IEC 947 series of standards evolved. This for the first time would bring all products relating to *low-voltage switchgear and control gear under one generic standard.

*Low voltage is defined as up to 1000V a.c. or 1500V D.C.

IEC 60947 Series – Specifications for low-voltage switchgear and control gear Product standards to 60947-X

Standard	Title / Product
IEC 60947-1 ¹	General Rules
IEC 60947-2 ²	Circuit-breakers
IEC 60947-3	Switches, disconnectors, switch disconnectors and fused combination units
IEC 60947-4 series	Contactors and motor starters
IEC 60947-5 series	Control circuit devices
IEC 60947-6 series	Multiple function switching devices
IEC 60947-7 series	Ancillary equipment e.g. terminals

¹ Products must comply with the relevant standard listed in this table. General Rules is a reference for the product standards and no product should be claimed to comply with IEC 60947-1.

² IEC 60947-2 and the corresponding BS EN 60947-2 are continually evolving to keep pace with the latest technology, providing enhanced performance and additional functions. Edition 4 was published in 2006.

In 1989 the International standard for air circuit-breakers IEC 157 was superseded by IEC 947-2. This was adopted as the European norm EN 60947-2 in March 1991. This was published in the UK as British Standard BS EN 60947-2 in May 1992 with the withdrawal of the dual standard IEC 157/BS 4752 in September 1992.

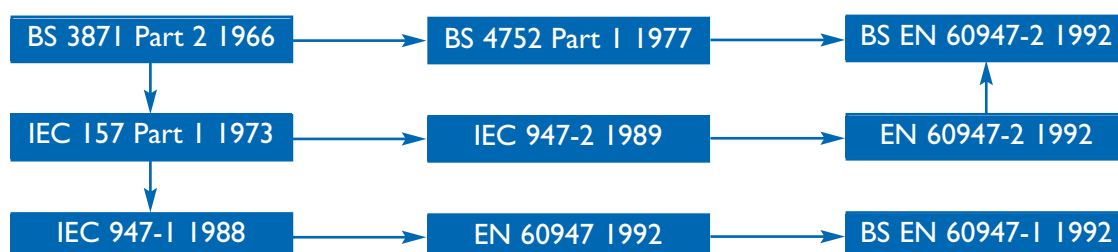

Circuit-breakers that complied with the relevant national standard before 30th September 1992, as shown by the manufacturer or by certification, were allowed to apply for production until September 1997. Since this date all circuit-breakers must comply with BS EN 60947-2.

4.2. BS EN 60947-2 Characteristics

4.2.1. Isolation

BS EN 60947-2 is precise in its requirements for circuit-breakers suitable for isolation by defining tests to which such units must comply. If the criteria for such tests are met the product must, if intended for use as an isolator, display the symbol illustrated below.

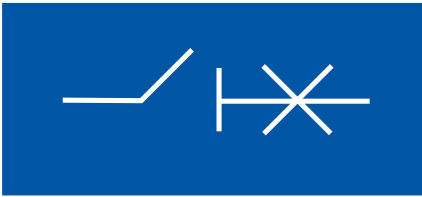

4.2.2. Selectivity Categories

BS EN 60947-2 recognises a classification according to the provision of time-delayed selectivity.

4.2.2.1 Selectivity Category A

Designates circuit-breakers not specifically intended for selectivity with devices on the load side. In other words circuit-breakers will discriminate only up to certain fault levels, above which discrimination with devices on the load side cannot be guaranteed.

4.2.2.2 Selectivity Category B

Designates circuit-breakers specifically intended for selectivity with devices on the load side. Such circuit-breakers will incorporate some form of time delay.

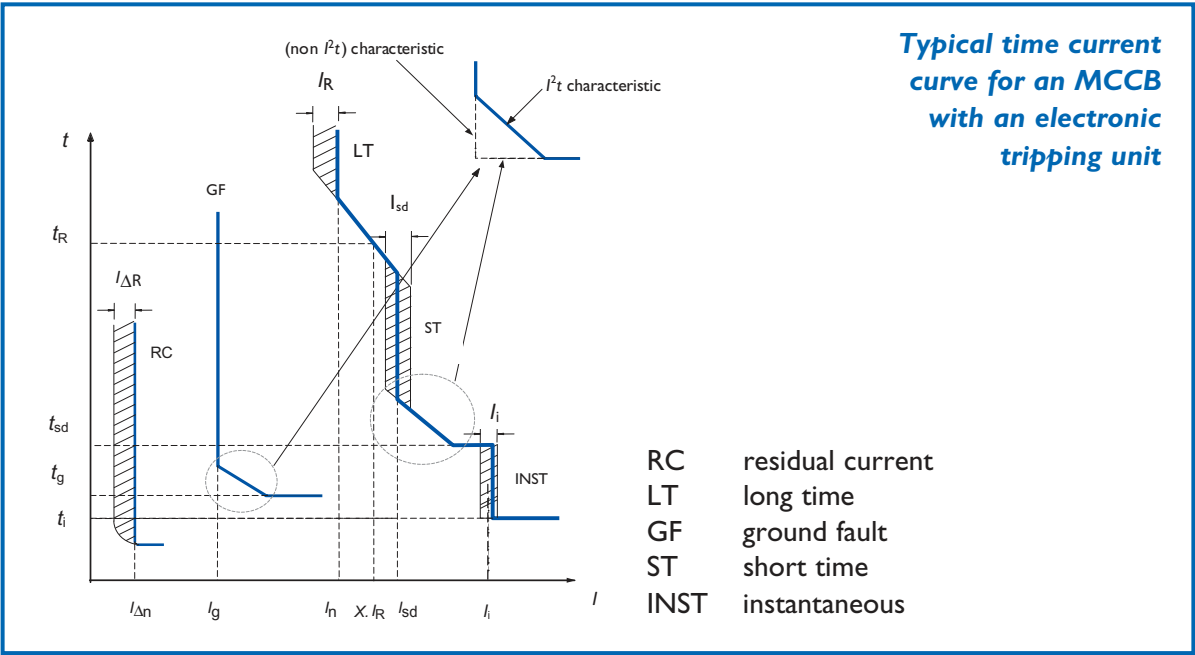

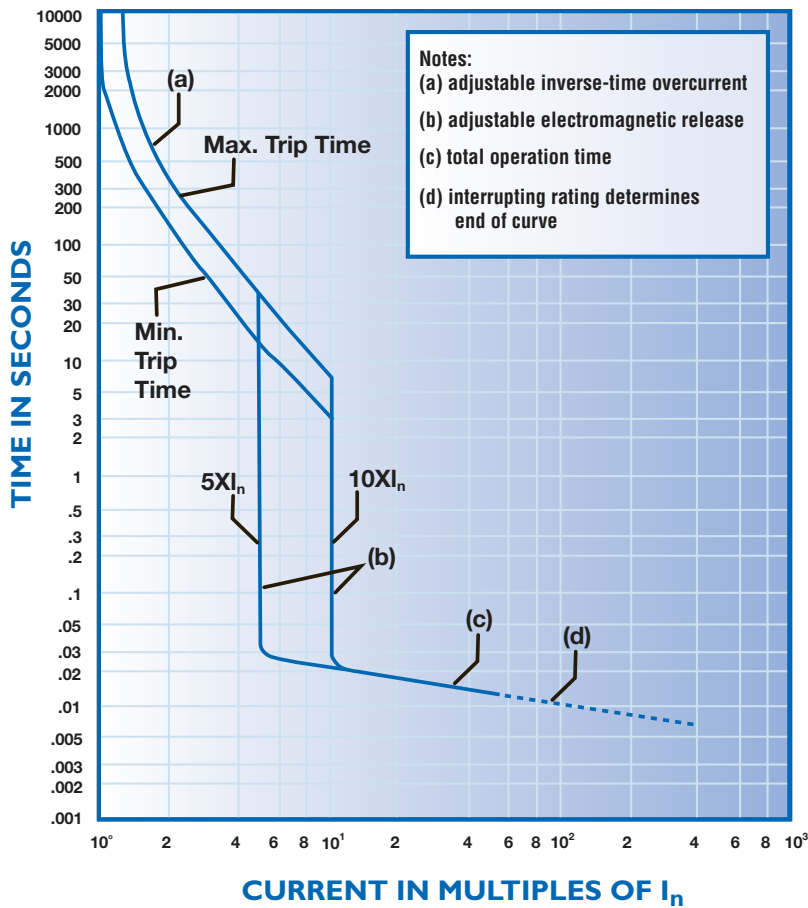

Typical time current curve for an MCCB with a thermal/magnetic tripping unit

4.3. BS EN 60947-2 – Rated Values

4.3.1. U_e Rated Operational Voltage

The nominal line-to-line voltage of the system should not exceed U_e

In IEC 60038 the voltage values of 230 V and 230/400 V have been standardised. These values have progressively replaced the values of 240 V, 220/380 V and 240/415 V.

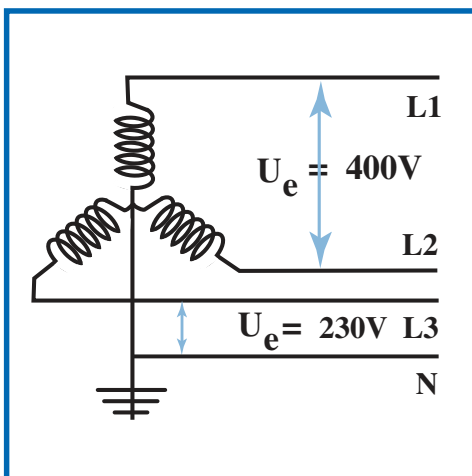

4.3.2. U_i Rated Insulation Voltage

The rated insulation voltage of a circuit-breaker is the value of voltage, assigned by the manufacturer, to which dielectric tests and creepage distances are referred.

Unless otherwise stated the rated insulation voltage is the value of the maximum rated operational voltage of the circuit-breaker. In no case shall the maximum rated operational voltage exceed the rated insulation voltage.

4.3.3. U_{imp} Rated Impulse Withstand Voltage

The peak value of an impulse voltage of prescribed form and polarity which the circuit-breaker is capable of withstanding without failure under specified conditions of test and to which the values of the clearances are referred.

It is the value of transient peak voltage the circuit-breaker can withstand from switching surges or lightning strikes imposed on the supply.

Example. $U_{imp} = 8kV$, Tested at 8 kV peak with 1.2/50 μs impulse wave, as shown below:

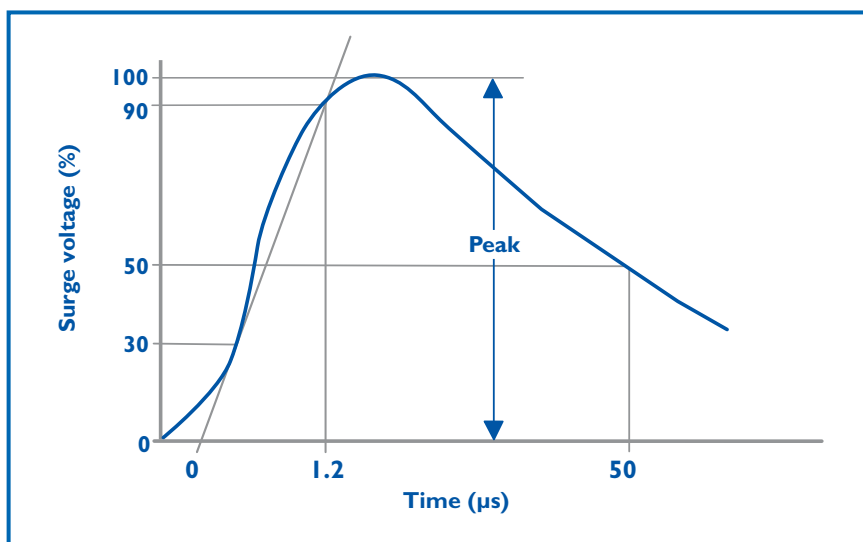

4.3.4. I_n Rated Current

The current that the circuit-breaker will carry continuously under specified conditions and on which the time/current characteristics are based.

Unless otherwise stated I_n is based on a reference ambient temperature of 30 °C.

4.3.5. Short Circuit-breaking Capacities

BS EN 60947-2 recognises both a rated ultimate (I_{cu}) and a rated service (I_{cs}) short circuit-breaking capacity for both selectivity category A and selectivity category B circuit-breakers.

4.3.6. I_{cu} Rated Ultimate Short-circuit Breaking Capacity

In order to define the value of I_{cu} the circuit-breakers under test must be subjected to a test sequence of:

$$I_{cs} = O - t - CO$$

Where:

O = opening operation under fault conditions.

t = time interval before re-closing (not less than 3 mins.)

CO = closing operation on to a fault.

After this test sequence, dielectric and overcurrent release tests are applied.

4.3.7. I_{cs} Rated Service Short-circuit Breaking Capacity

In order to define the value of I_{cs} the circuit-breakers under test must be subjected to a test sequence of:

$$I_{cs} = O - t - CO - t - CO$$

Where:

O = opening operation under fault conditions.

t = time interval before re-closing (not less than 3 minutes)

CO = closing operation on to a fault.

After this test sequence, load-switching, dielectric, terminal temperature and overcurrent release tests are applied. The circuit-breaker must meet certain test parameters to ensure that the circuit-breaker has not deteriorated in performance and can, in fact, be put back into service.

4.3.8. Application of Breaking Capacities

The rated service short circuit-breaking capacity (I_{cs}) applies to short-circuit faults that could occur in practice, whereas the rated ultimate short-circuit-breaking capacity (I_{cu}) is the maximum theoretical fault value of the installation at the point of connection.

Thus a circuit-breaker can remain in service after interrupting a short-circuit up to its rated value of I_{cs} . Where two or more faults occur between the I_{cs} and I_{cu} values, the continued operation of the circuit-breaker must be verified.

I_{cs} may be expressed as a value of current or a percentage of I_{cu} . I_{cs} must be at least 25% of I_{cu} .

The calculated prospective fault current at the incoming terminals of the circuit-breaker should not exceed I_{cu} . Exception: Using back up protection as specified by the manufacturer.

4.3.9. Energy let-through (I^2t)

Energy let-through is not a rated value but is used in the consideration of back-up and selectivity. I^2t is a measure of the energy let-through by the circuit-breaker under short-circuit conditions. I^2t is used at fault current levels where the short time to operate does not lend itself to the use of time current curves.

4.3.10. I_{cw} Rated Short-Time Withstand Current

Circuit-breakers of Selectivity Category B have a short-time delay (STD) allowing time-graded selectivity between circuit-breakers in series.

I_{cw} is the fault current the circuit-breaker will withstand for the maximum short-time delay time.

Preferred times are: 0.05, 0.1, 0.25, 0.5 and 1.0 second.

Example:

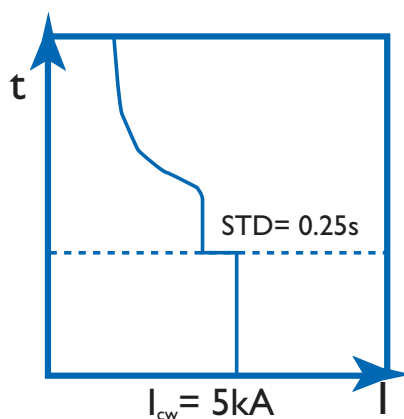

4.3.11. BS EN 60947-2 Additional Functions

Specific functions provided by some circuit-breakers are covered in a number of annexes to BS EN 60947-2. Circuit-breakers with all or some of these additional functions need to comply with both the main body of the standard and the relevant annex.

Annexes of circuit-breaker specific functions

Annex	Subject	Acronym
B	Circuit-breakers incorporating residual current protection (RCD function)	CBR
F	Circuit-breakers with electronic overcurrent protection	-
L	Circuit-breakers without overcurrent protection. (Used for isolation and switching)	CBI
M	Modular residual current devices. A modular arrangement of devices, some remote, arranged to switch-off a circuit breaker under earth fault conditions.	MRCD
O	Instantaneous trip circuit-breakers (without overload releases). Principally coordinated with motor starters for short-circuit protection.	ICB

4.4. Installation Factors

4.4.1. BS EN 60947-2 Overcurrent Co-ordination

Annex A of BS EN 60947-2 gives the principles of back-up protection and selectivity (discrimination) applied to circuit-breakers. The tests therein permit the manufacturer to establish enhanced short-circuit ratings for circuit-breakers in series or when backed-up by fuses. In addition the limits of selectivity between circuit-breakers in series may be established. The data obtained is published in the manufacturer's literature.

Additional information on the principles of back-up and selectivity, as applied to all low-voltage equipment, is available in BSI publications PD IEC TR 61912-1 and PD IEC TR 61912-2.

4.5. Determination of maximum earth-loop impedance (Z_s)

In order to provide protection against electric shock in accordance with the Wiring Regulations (BS 7671), it is necessary to determine the maximum value of Z_s that will give the required disconnection time.

In the case of circuit-breakers to BS EN 60898-1 and fuses, Z_s is tabulated in the Wiring Regulations. This is possible because these devices have standardised, fixed, characteristics common to all such devices.

In the case of circuit-breakers to BS EN 60947-2 the characteristics are not standardised and, in most cases, are adjustable. In addition, circuit-breakers with electronic trip units may have adjustable time-delay and curve-shaping features. These features enhance the ability to provide circuit protection and co-ordination of devices. However the selected settings must then be applied to the determination of Z_s .

In this case Z_s is determined from the basic equation:-

$$Z_s I_a \leq U_o C_{min} \text{ – which transposes to: -}$$
$$Z_s \leq \frac{U_o C_{min}}{I_a}$$

where:-

U_o is the nominal voltage to earth.

I_a is the current required to achieve the disconnection time as given in the Regulations.

C_{min} is the minimum voltage factor to take account of voltage variations depending on time and place, changing of transformer taps and other considerations.

NOTE: For a low voltage supply given in accordance with the Electricity Safety, Quality and Continuity Regulations 2002 as amended, C_{min} is given the value 0.95.

In determining I_a from the tripping characteristic, any applicable tolerances must be taken into account and the maximum value of I_a used. In general the tolerance band for the inverse time/current portion of the curve is given (see example below) and no further allowance needs to be made. In the case of the instantaneous (< 0.2 s) operating portion of the curve e.g. an electromagnetic release, the standard tolerance is $\pm 20\%$ of the current. The manufacturer may alternatively state a lower tolerance. Example: Using the typical characteristic curves illustrated on page 28.

Note that the current axis is in multiples of I_n (rated current) allowing the use of the same characteristic for different ratings.

Assume a rating of $I_n = 100 \text{ A}$ and $U_o = 230 \text{ V}$ with an electromagnetic release setting of $7.5 \times I_n = 750 \text{ A}$.

It can be seen that for both a 0.4 second disconnection time and a 5 second disconnection time the inverse time/current curve is too slow and the electromagnetic release must be used. Thus, applying the tolerance of + 20%:-

$$Z_s \leq \frac{230 \times 0.95}{750 \times 1.2} = 0.24 \text{ ohms}$$

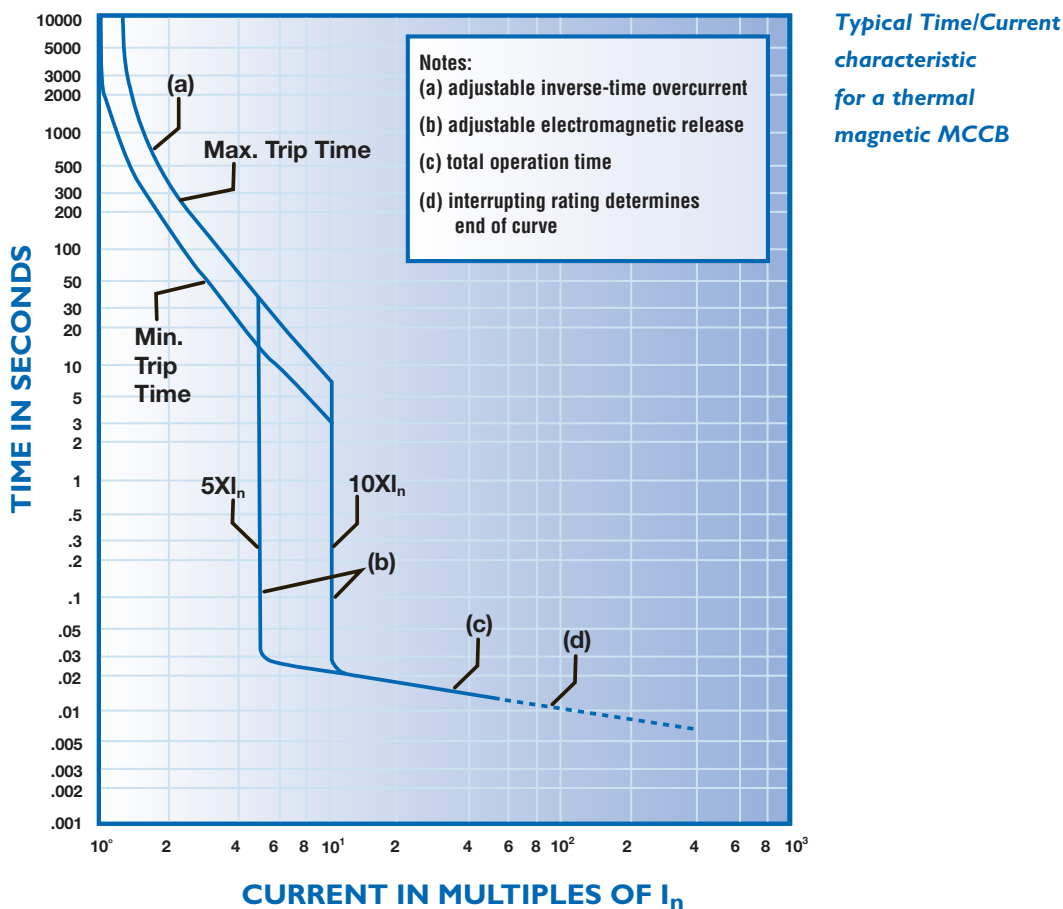

4.6 Harmonic Currents

Harmonic currents are those in which the nature of the load distorts the current waveform, generally due to electronic control of the current e.g. electronic ballasts in lighting, inverter drives, UPS systems.

Harmonics are expressed as a multiple of the mains frequency (50Hz in UK) e.g. the 3rd harmonic has a frequency of $3 \times 50 = 150 \text{ Hz}$.

There are a number of factors to be considered relative to circuit-breakers:-

4.6.1. Overload protection

Circuit-breakers with bimetallic thermal overload protection use a trip release that responds to the heating effect of the overload current i.e. they respond to the true RMS value of the current waveform. This type of circuit-breaker and circuit-breakers with electronic overcurrent protection conforming to Annex F of BS EN 60947-2 will provide protection to the circuit conductors in the case of overload currents including harmonics.

4.6.2. Neutral currents

Third harmonics and their multiples in a 3-phase system accumulate in the neutral conductor, even when the load currents in the phases are balanced. This needs to be allowed for in the sizing of the neutral in equipment and conductors.

BS 7671:2008 (2015) states “If the total harmonic distortion due to third harmonic currents or multiples of the third harmonic is greater than 15% of the fundamental line current the neutral conductor shall not be smaller than the line conductors”.

In the case of significant neutral currents due to harmonics a 4-pole circuit-breaker with a protected neutral pole may be required to protect the neutral conductor.

4.6.3. Unwanted operation due to harmonic currents

Circuit-breakers with electronic overcurrent protection conforming to Annex F of BS EN 60947-2 have immunity to unwanted operation in the presence of specific percentages of odd harmonic currents.

Note: Conformity to Annex F of BS EN 60947-2 is indicated by either marking ‘r.m.s.’ on the circuit-breaker or is given in the manufacturer’s literature or both.

5. Technical And Application Data – all Low Voltage Circuit-breakers to BS EN 60898-1, BS EN 60898-2 and BS EN 60947-2

5.1. Circuit-breaker substitution in assemblies

BEAMA warns against the practice of installing circuit-breakers (e.g. MCCBs, MCBs) of one manufacturer as replacements or substitutions for devices of another manufacturer, without the necessary verification of performance.

Assemblies such as consumer units, distribution boards and panelboards are verified with specific devices installed; these devices are more often than not from the same manufacturer as the assembly. Verification will have been undertaken, by the ASSEMBLY manufacturer, to BS EN 61439-2 or BS EN 61439-3 (formerly BS EN 60439-1 and BS EN 60439-3 respectively).

Substituting devices not verified by the assembly manufacturer invalidates any testing/verification and warranty.

BS 7671 puts the specific responsibility on the installer; regulation 510.3 requires that the installer takes into account the manufacturer's instructions in regard to devices fitted. It is, therefore, the responsibility of the installer who plans to substitute a device, for whatever reason, to a) obtain authority from the assembly manufacturer or b) undertake appropriate verification to ensure conformity with the current BS EN standard. If this is not carried out then there is a probability that, in the event of accident, a fire or other damage, the installer would be accountable under Health and Safety legislation.

Although devices from different manufacturers may appear similar, the technical performance, dimensions, and terminations are not necessarily compatible.

5.2. Functional switching with Circuit-breakers

Circuit-breakers and RCBOs are primarily circuit-protective devices and, as such, they are not intended for frequent load switching. Infrequent switching of circuit-breakers on-load is admissible for the purposes of isolation or emergency switching.

For a more frequent duty the number of operations and load characteristics according to the manufacturer's instructions should be taken into account. Preferably an alternative device should be selected (See Table 53.4 of BS 7671) e.g. a contactor to BS EN 60947-4 or BS EN 61095 or a switch to the BS EN 60669 series.

5.3. Coordination of Low voltage Switchgear and Controlgear assemblies with conductors operating at a temperature exceeding 70°C e.g. XLPE

BS 7671 regulation 512.1.5 requires that “Switchgear, protective devices, accessories and other types of equipment shall not be connected to conductors intended to operate at a temperature exceeding 70°C at the equipment in normal service, unless the equipment manufacturer has confirmed that the equipment is suitable for such conditions”.

BS 7671 regulation; 523.1 (note b) requires that “Where a conductor operates at a temperature exceeding 70°C, it shall be ascertained that the equipment connected to the conductor is suitable for the resulting temperature at the connection”.

BS 7671 90°C cable tables e.g. Table 4E4, state that; “Where cables in this table are connected to equipment or accessories designed to operate at a temperature not exceeding 70°C, the current ratings given in the equivalent table for 70°C thermoplastic insulated cables (Table 4D4A) must be used (see also Regulation 523.1)”.

The above specifically applies to low voltage switchgear and controlgear assemblies which include switchboards, panelboards, distribution boards, busbar trunking systems and consumer units. It also applies to wiring accessories which includes wall switches, socket-outlets, fused spurs and plugs.

The British (BS) and harmonized (BS EN) standards for these products contain test limits that apply to thermoplastic insulation i.e. PVC, and specifically to low-voltage assemblies, where the terminals of the built-in component e.g. MCCBs/MCBs, also contain the terminals for external insulated conductors.

Unless specified by the manufacturer, conductors operating at a temperature exceeding 70°C are not suitable or safe for use with wiring accessories, low-voltage switchgear and controlgear assemblies. However, 90°C rated cable can be used for external wiring provided the conductor operating temperature does not exceed 70°C i.e. where the electrical design is based on current ratings given in the equivalent table for 70°C thermoplastic insulated cables.

Specifically for a low-voltage switchgear and controlgear assemblies, whenever a declaration states that **built-in components (e.g. mcbs / mccbs) which also contain the terminals for external insulated conductors**, are suitable for conductors operating at a temperature exceeding 70°C, then the **components must have been tested in the assembly as part of the appropriate assembly standard**.

5.4. Overcurrent coordination of devices from different manufacturers

Backup protection of a circuit-breaker by use of an SCPD is only accurately verified by test, appropriate data can be obtained from the manufacturer.

Selectivity between devices is only precisely established by test; however, guidance for a method of establishing selectivity by a desk study is given below.

5.4.1. Selectivity in the overload zone

Circuit-breakers in series (downstream (C1) and upstream (C2)) – selectivity determination by comparison of characteristics.

Selectivity in the overload zone is verified by comparison of the time/current characteristics. Separation of the characteristics in both the time and current axes ensures selective operation of C1 with respect to C2, in this zone. There will be a tolerance applicable to the characteristics, which should be taken into account. The manufacturer's data should show a tolerance band or otherwise indicate the tolerance applicable, as required by the product standard.

5.4.2. Circuit-breaker (C1) with fuse as SCPD – selectivity determination by comparison of characteristics

Selectivity in the overload zone is determined by the comparison of time/current characteristics. Separation of the characteristics in both the time and current axes ensures selective operation of C1 with respect to the fuse, in this zone. There will be a tolerance applicable to the characteristics, which should be taken into account. The manufacturer's data should show a tolerance band or otherwise indicate the tolerance applicable, as required by the product standard.

5.4.3. Determination of selectivity in the fault current (short-circuit) zone

Determination from time/current characteristics, of selectivity between two circuit-breakers in the fault current (short-circuit) zone, is limited to the case where C2 has a short-circuit release time-delay function provided by an electronic release.

5.4.3.1 Circuit-breakers in series (C1 and C2) – selectivity determination by consideration of peak let-through current

In the case where the instantaneous tripping of C2 depends on an electromagnetic effect (i.e.. thermal/magnetic or magnetic-only circuit-breaker) or in the case of an electronic trip unit with an instantaneous release, the minimum level of selectivity between two circuit-breakers in the fault current zone may be determined as follows:

Selectivity is assured up to the fault current level at which the peak current let-through of C1 is less than the peak value corresponding to the instantaneous tripping level (I_i) of C2 taking into account the tolerance.

EXAMPLE:

C2 = 800 A MCCB; $I_i = 8 - 12$ kA r.m.s. (10 kA setting ± 20 %); C1 = 125 A MCCB.

Minimum tripping level of C2 is $8 \times 1,414 = 11.3$ kA peak.

Let-through current of C1 at 15 kA r.m.s. prospective, due to the current limitation of C1, is 11 kA peak, from test data.

Therefore the system is selective to at least 15 kA r.m.s. prospective.

Note: the selectivity limit obtained by this method will err on the low side and the actual limit determined by test will be significantly higher in most cases.

5.4.3.2 Circuit-breaker (CI) with fuse as SCPD

Selectivity in the fault-current (short-circuit) zone (see 3.11) is determined from the I^2t characteristics. The selectivity limit current I_s is the maximum value at which let-through I^2t of the circuit-breaker is lower than the pre-arcing I^2t of the fuse. In the absence of an actual curve the manufacturer's quoted I^2t pre-arc value for the fuse is taken.

5.4.4. Determination of selectivity limit current for specific installation conditions

Data on selectivity limits may be supplied in tabulated form, graphically or as software media. Data obtained from either a desk study or tests, to this standard, will be based on the prospective fault current level at the incoming device (C2) and assumes that the coordinated devices are in close proximity. In practice the selectivity limit will be influenced by the impedance between the two devices. Therefore, in the practical situation taking the prospective fault current at the downstream circuit-breaker will give a more precise value for the selectivity limit.

Companies involved in the preparation of this Guide

Eaton Electric Ltd

Reddings Lane
Tyseley
Birmingham
United Kingdom
B11 3EZ

Tel: 08700 545 333
Fax: 08700 540 333
Email: ukcommorders@eaton.com

www.eatonelectrical.com

Electrium Sales Ltd Commercial Centre

Lakeside Plaza
Walkmill Lane
Bridgtown, Cannock
Staffordshire
United Kingdom
WS11 0XE

Tel: +44 (0) 1543 455000
Fax: +44 (0) 1543 455001
Email: info@electrium.co.uk

www.electrium.co.uk

Hager Engineering Ltd

Hortonwood 50
Telford
Shropshire
United Kingdom
TF1 7FT

t: +44 (0) 1952 677899
f: +44 (0) 1952 675581
Email: info@hager.co.uk

www.hager.co.uk

Legrand Electric Ltd

Great King Street North
Birmingham
United Kingdom
B19 2LF

Tel: +44 (0) 121 515 0515
Fax: +44 (0) 121 515 0516
Email: legrand.sales@legrand.co.uk

www.legrand.co.uk

MK Electric

The Arnold Centre
Paycocke Road
Basildon
Essex
United Kingdom
SS14 3EA

Tel: +44 (0) 1268 563000
Fax: +44 (0) 1268 563563
Email:
mk.technical@honeywell.com

www.mkelectric.co.uk

Siemens plc

Sir William Siemens House
Princess Road
Manchester
England M20 2UR

Tel: +44 (0) 161 446 5308
Fax: +44 (0) 161 446 5352
Email:
cdtech@plcman.siemens.co.uk

www.siemens.co.uk

Schneider Electric Ltd

Stafford Park 5
Telford
Shropshire
United Kingdom
TF3 3BL

Tel: +44 (0) 0870 608 8608
Fax: +44 (0) 0870 608 8606

www.schneider-electric.com

Timeguard Ltd

Victory Park
400 Edgware Road
London
NW2 6ND

Tel: 020 8450 8944
Fax: 020 8452 5143
Email: csc@timeguard.com

www.timeguard.com

Western Automation Research & Development Ltd

Poolboy
Ballinasloe
Co Galway
Ireland

Tel: 00 353 90 9643359
Fax: 00 353 90 9643094

Email:
info@westemautomation.com

www.westemautomation.com



BEAMA Limited

Westminster Tower

3 Albert Embankment

London

SE1 7SL

Telephone: +44 (0)20 7793 3000

Fax: +44 (0)20 7793 3003

Email: info@beama.org.uk

www.beama.org.uk

BEAMA Limited is registered in England No. 84313