

Keeping electrical switchgear safe



Failure of electrical switchgear can cause death, serious injury and major damage. If you own or operate this type of equipment in industrial or commercial organisations, this book is mainly aimed at you. It should help you to select, use and maintain switchgear safely and reduce the risk of accidents.

HSG230 (2nd edition)
Published 2015

© *Crown copyright 2015*

First published 2002
Second edition 2015

ISBN 978 0 7176 6557 0

You may reuse this information (excluding logos) free of charge in any format or medium, under the terms of the Open Government Licence. To view the licence visit www.nationalarchives.gov.uk/doc/open-government-licence/, write to the Information Policy Team, The National Archives, Kew, London TW9 4DU, or email psi@nationalarchives.gsi.gov.uk.

Some images and illustrations may not be owned by the Crown so cannot be reproduced without permission of the copyright owner. Enquiries should be sent to copyright@hse.gsi.gov.uk.

This guidance is issued by the Health and Safety Executive. Following the guidance is not compulsory, unless specifically stated, and you are free to take other action. But if you do follow the guidance you will normally be doing enough to comply with the law. Health and safety inspectors seek to secure compliance with the law and may refer to this guidance.

Contents

Introduction 5

- Scope 5
- Background 5
- What does the law require? 5

Switchgear safety 6

- Understand your system 6
- Maintenance 7
- Design rating and system modifications 8
- Design modifications and limitations on use 8
- Dependent manual operating mechanisms 8
- Anti-reflex handles 9

Management of switchgear 9

- Management systems 9
- Training and competence 10
- Operational safety documents 11
- Network diagram 12
- Maintenance systems and asset registers 12
- Maintenance records 13

Operation of switchgear 13

- Fault level and ratings 13
- Effect of on-site generation and other large rotating machines 14

Reducing the risk of switchgear failure 14

- Overstressed switchgear 14
- Dependent manually operated (DMO) switchgear 15
- Fault clearance 16

Care and maintenance of HV switchgear: Common requirements 16

- Time-based preventive maintenance 16
- Condition-based maintenance 17
- Reliability-centred maintenance (RCM) 18
- Switchgear availability 18
- Trip-testing 18
- Protection testing 19
- Tests to be undertaken following maintenance 19
- Routine inspection of substations and switch rooms 19
- Signs of abnormal conditions 19
- Equipment environment 20
- Visual examination of switchgear 20
- General services 20
- Circuit-breakers subject to special duty 21
- Disposal issues, post-maintenance 21

Care and maintenance of oil-filled switchgear 21

- Maintenance procedures 22
- Frequency of maintenance 23

Cleaning and inspection of oil-filled switchgear 23
Tank cleaning techniques 24
Insulating oil 24
Post-fault maintenance of oil-filled circuit-breakers 25

Care and maintenance of non-oil switchgear 25

General guidance 25
Maintenance procedures: Vacuum switchgear 26
Maintenance procedures: Air-brake switchgear 27
Maintenance procedures: SF₆ switchgear 27
SF₆ gas handling and safety precautions 28
Release of SF₆ 28
Hazards 28
Sampling 29

Care and maintenance of ancillary equipment 29

Test probes 29
Earthing equipment 30

Assessment of aged switchgear 31

Protection 34

Protection relay schemes 34
Fuse protection 35
Batteries and chargers 35

Selection of new, replacement or refurbished switchgear 36

General advice 36
Retrofit circuit-breakers for withdrawable switchgear 37
Second-hand equipment 37

Measures to limit fires 37

Compartmentation 37
Control and extinction 37
Detection 37
Safety issues 38

Appendix 1: Examples of switchgear configurations 39

References and further reading 47

Glossary 49

Further information 50

Introduction

1 This guidance is aimed at owners and operators of electrical switchgear in industrial and commercial organisations. It may also be useful to others. It will help managers, engineers and others to understand their responsibilities and duties in the selection, use, operation and maintenance of high-voltage switchgear. Some knowledge of electrical switchgear and distribution systems is necessary to gain most benefit from this document. Owners and operators of electrical switchgear with little electrical knowledge or expertise should refer to *Electrical switchgear safety: A guide for owners and users*.¹

Scope

2 Guidance is given on the selection, use, operation and maintenance of three-phase electrical switchgear with voltage ratings from 1 kV alternating current (AC) up to and including 33 kV AC. This includes circuit-breakers, switches, switch fuses, isolators and high-voltage (HV) contactors that use oil, air, sulphur hexafluoride (SF₆) or vacuum as the interrupting medium. Guidance is also provided on assessing risks associated with aged switchgear and the actions necessary when considering replacement or refurbishment of switchgear. Low-voltage (ie below 1 kV) equipment is out of the scope of this guidance, although some references are made to low-voltage (LV) equipment where it is an essential part of an HV system.

3 This guidance does not address direct current (DC) switchgear, switchgear used on single-phase AC traction systems, or power electronic switching devices used at high voltage such as inverters, cyclo-converters and rectifiers.

Background

4 Switchgear failures are rare, but when they do occur, the results can be catastrophic. In the case of oil-filled switchgear, burning oil and gas can be ejected, causing death or serious injury to people who may be nearby, and major damage to equipment and buildings. Switchgear using SF₆ gas or vacuum as the insulating medium presents other risks that need to be controlled and managed.

5 Failures are most likely to occur during, or shortly after, switchgear operation. The way switchgear is operated, its condition and the conditions in the electrical system at the time it operates will largely determine whether it will function safely.

What does the law require?

6 The Health and Safety at Work etc Act 1974 (the HSW Act),² the Management of Health and Safety at Work Regulations 1999 (the Management Regulations)³ and the Electricity at Work Regulations 1989 (EAWR)⁴ are applicable to the selection, use, operation and maintenance of high-voltage switchgear. The HSW Act also places duties on the manufacturers of switchgear.

7 Older switchgear may contain parts that were manufactured from asbestos or asbestos-containing materials (ACMs). The Control of Asbestos Regulations 2012⁵ place a duty on those who have responsibility for the maintenance and repair of equipment to manage the risks from the potential for exposure to asbestos. This includes the responsibility to determine if asbestos is present so that others can be made aware of the hazard and take appropriate action. Advice should be sought from the original equipment supplier or a specialist maintenance provider on the likelihood of asbestos or ACMs being present in switchgear.

8 The HSW Act requires employers to ensure, so far as is reasonably practicable (see paragraph 11), the safety of employees and other people who may be affected by their activities. Similarly, self-employed people while at work must ensure that they do not expose themselves to risks to their own health and safety, and that they do not affect the health and safety of others.

9 The Management Regulations require an employer or self-employed person to make an assessment of the risks to employees and others. To do this, they should consider what might cause harm to people and decide whether they are doing enough to prevent that. For more information on risk assessment, see *Risk assessment: A brief guide to controlling risks in the workplace*.⁶

10 The EAWR requires electrical equipment, which includes switchgear, for use at work to be constructed, maintained and operated in such a way as to prevent, so far as is reasonably practicable, danger. Electrical equipment, including switchgear, must not be used where its strength or capability may be exceeded, unless it is used in such a way that nobody could be exposed to danger. This includes protection against the effects of excess current and exposure to the physical environment in which the switchgear is located. People who work on or near to electrical equipment, and those responsible for managing such work activities, must be suitably competent for the activity to be undertaken (ie they must have the appropriate level of technical knowledge or experience). Alternatively, those working on switchgear must be suitably supervised.

11 'So far as is reasonably practicable' means balancing the level of risk against the measures needed to control the real risk in terms of money, time or trouble. However, you do not need to take action if it would be grossly disproportionate to the level of risk. In the context of HV switchgear, the procedures to select and maintain suitable equipment and to ensure the safety of those working on or near it are well established. These are supported by existing standards, guidance and training qualifications. Many organisations successfully apply these measures to the management of their switchgear. For certain work activities on switchgear, there can be a risk of death, and this must be taken into account when considering the measures needed to ensure safety when such tasks are completed. For more information, see *Risk assessment: A brief guide to controlling risks in the workplace*.

Switchgear safety

12 The use, maintenance and operation of high-voltage switchgear must be managed to prevent both the equipment giving rise to danger and to ensure the safety of the people who use it. Allowing equipment to become unsafe and, as a result, exposing people to danger during its use is likely to breach the law. Oil-filled switchgear presents particular issues not encountered with other types of equipment.

Understand your system

13 Switchgear varies in size, age and appearance. Examples are shown in Appendix 1. Different types of switchgear such as switches, isolators, switch fuses, contactors and circuit-breakers have different switching and fault-handling capabilities. It is important to be able to recognise the different types of switchgear and understand the differences in their capability. Failure to do so can result in switchgear being used incorrectly, which may be dangerous for the operator.

14 Some switchgear may appear to be of robust construction due to its size. Despite appearances, it may have limited operational capability and be restricted in

the way it should be used. Any limitations or restrictions must be understood by those who operate or maintain the equipment.

15 HV switchgear may be located close to machinery controlled by it. People who have access to the switchgear may not be electrically competent, but must be made aware of its presence and the potential hazards associated with it. They should know what to do if they notice anything unusual or wrong with the switchgear.

16 In certain industries, the location of switchgear in relation to the process activity is important. For example, for explosives manufacture and storage, HV equipment should be sited outdoors, see *Explosives Regulations 2014: Safety provisions. Guidance on Regulations*.⁷ It is important that the location of HV switchgear is considered if the use of a premises changes.

17 Switchgear must only be operated by people who are competent to do so. Being competent means having sufficient knowledge or experience to prevent danger or injury; or being under such degree of supervision as may be appropriate for the nature of the work. Switchgear operated incorrectly can result in danger both to those operating it and others. Experience will include an understanding of the operation of the switchgear and knowledge of the arrangement of the system in which it is installed. People who are required to operate older switchgear must be specifically trained and experienced in its use. They must be aware of its limitations. People trained only on more modern equipment may not have such knowledge.

18 People with the necessary competence to operate switchgear are often referred to as 'authorised persons'. A system should be in place to assess and appoint the people who can operate switchgear (authorised persons), record who they are, what training they have received, what experience they have, what items of switchgear they are permitted to operate, and what duties they are authorised to undertake. If no one within an organisation has the necessary competence to make the assessments to appoint people or to operate switchgear, someone should be developed to fulfil this role, or it must be given to an independent organisation with the necessary competence. It may be necessary to consider arrangements for support outside normal working hours. Even if the operation and maintenance of switchgear is contracted to an external provider, the owner of the switchgear retains a legal responsibility for its safe operation and maintenance.

19 A number of organisations (eg electricity distribution companies or specialist training organisations) can provide training. Attending a training course alone is unlikely to demonstrate that an individual has adequate technical knowledge or experience to satisfy the legal requirement for competence. Depending on the work to be undertaken, it is likely that specific experience of the switchgear to be operated and an understanding of the system in which it is installed will be necessary to prevent danger.

Maintenance

20 A system must be in place to ensure that switchgear is maintained appropriately by people competent to do so, at an appropriate frequency to provide assurance that it remains in a safe condition. Oversights, lack of knowledge, lack of the necessary skills, or concerns over the impact of a loss of power are common reasons for failing to maintain HV switchgear. Failure to carry out maintenance may result in the switchgear not operating when required to do so. This can place unnecessary stress on switchgear elsewhere within a system and result in more extensive damage if faults do occur. The switchgear may also become dangerous to operate.

Design rating and system modifications

21 Switchgear is described as being 'overstressed' when it is operated beyond its design rating. This could be due to excess load or where the fault energy (the energy that the switchgear would need to carry, make or interrupt in the event of an electrical fault) exceeds the capability of the switchgear. If required to operate under these conditions, overstressed switchgear may not cope with the electrical, magnetic and thermal stresses imposed upon it. This can result in it failing catastrophically with the potential to cause injury. Switchgear must not be used where its strength and capability may be exceeded, unless it is used in such a way that nobody could be exposed to danger.

22 When originally installed, switchgear should have been adequately rated for the duty it was intended to perform. Changes to an electrical system can result in switchgear becoming overstressed. Careful consideration must be given to system modifications to ensure that dangerous conditions are not created. Changing the configuration of a system through switching operations that put transformers into parallel operation can result in an increase in fault energy. Such arrangements may result from a response to abnormal system conditions or be necessary during planned maintenance work. Interlock systems should be used to prevent overstressing in such circumstances. Where it is not possible to use interlocks, clear operating instructions must be provided to prevent configurations that have the potential to overstress switchgear.

Design modifications and limitations on use

23 During the life of switchgear, defects with the original design or manufacturing process may become apparent. Manufacturers may recommend modifications, some of which may be required for the continued safe operation of the switchgear. While manufacturers must inform the original purchaser of modifications required to prevent danger, it is the current owner and operator of the switchgear who has the legal duty to ensure it remains safe. Audits at appropriate intervals can be helpful to identify switchgear that may require modification. These could involve either the switchgear manufacturer or specialist maintenance providers. Modifications essential for safety must be completed. If defects relating to safety are identified and result in restrictions on the use of switchgear, the people who operate or maintain the equipment must be made aware of the restrictions so that they can perform their work safely.

Dependent manual operating mechanisms

24 Dependent manual operating (DMO) mechanisms used to be fitted to both HV and LV switchgear. Although no longer made, they may still be in use on some systems. In switchgear fitted with DMO mechanisms, the operator opens and closes the contacts within the switchgear solely by manual effort. Movement of the contacts is dependent on the speed and actions of the operator. Hesitancy can lead to failure of the switchgear with potentially fatal consequences. Under some circumstances, such as operation during fault conditions, it may be physically impossible to close a DMO switch due to the electromagnetic forces involved. Attempting to operate switchgear under fault conditions can cause it to fail.

25 Where DMO switchgear is in service, it must only be used by people who have been trained specifically in its use and are aware of the potential danger associated with its operation. In general, the switchgear should only be operated after first being made dead by the operation of other switchgear which is suitably rated and does not have a DMO mechanism. Similarly, it should only be put back into service through the operation of such switchgear. See paragraphs 56–59 for further information on DMO switchgear.

26 There is a foreseeable risk associated with the use of DMO switchgear. It is foreseeable that such equipment present within an electrical system may at some time be used. It is a legal requirement that all systems shall at all times be of such construction as to prevent, so far as is reasonably practicable, danger. It is highly recommended that DMO switchgear is replaced.

Anti-reflex handles

27 Oil switches, such as those incorporated within ring main units, may be rated to close onto a fault but not to interrupt fault current (sometimes referred to as fault make, load break switches). Where switchgear using oil switches is also fitted with integral earthing, incidents have resulted when a failure to check the position of the selector mechanism has led to operators switching from OFF to EARTH instead of from OFF to ON. This action has the potential to put an earth fault onto the HV system. This is not necessarily a dangerous situation as oil switches are designed to close onto a fault, but danger arises if the operator, realising that a mistake has been made, instinctively reacts and attempts to open the switch. Oil switches are not rated to interrupt fault current, and where this has occurred, switches have failed, causing serious injury to the operator.

28 To address this problem, manufacturers supply 'anti-reflex' handles. These are handles that have to be removed and re-inserted before they can be used to reverse the operation of an oil switch. They are provided to ensure that if a mistake is made, it is not possible to immediately reverse a switching action. This may allow sufficient time for circuit protection to operate, clearing a fault by operating a circuit breaker or other device designed to break fault current, or it will provide thinking time for an operator before making the conscious decision to reverse a switching action.

29 A review of oil switches and oil switch fuses present on a system should be undertaken to determine if anti-reflex handles have been provided. If not, it is advisable to replace standard handles with anti-reflex handles.

Management of switchgear

Management systems

30 Establishing and implementing a formal system for the management and control of an electrical distribution system is an effective and practical way of demonstrating compliance with a number of legal requirements. When correctly implemented, a management system can help address the safety issues identified with the operation, use and maintenance of HV switchgear. A management system for a distribution system need not be complex; the requirements should be proportionate to the complexity of the system.

31 Record keeping is an important part of a management system, in terms of having both adequate information about the equipment on a system, and information about the competency and responsibilities of those authorised to work on it. A management system for HV switchgear may include:

- policies and procedures for the installation, commissioning, operation and maintenance of HV switchgear. These should include the arrangements for authorising people to work on the switchgear and the training, experience and development requirements to be satisfied before people are authorised to operate switchgear. Procedures should include safe systems of work which are likely to include the use of safety documents such as permit-to-work systems (see *Electricity at work: Safe working practices*);⁸

- manufacturers' operating instructions for each item of switchgear and associated ancillary equipment (such as battery chargers, protection relays and fire detection systems). This should include access to any safety bulletins issued by the equipment manufacturers;
- drawings (such as a network diagram – see paragraph 41) and technical information (such as protection type, grading and fault level studies);
- definition of responsibilities and training records for people who have been authorised to use or work on the equipment;
- maintenance and operating records; recording the results of maintenance activities, repairs, modifications and any significant faults that may have occurred for each item of equipment; and
- systems for auditing the effectiveness of the management system, records of the audits completed and the actions taken to rectify any deficiencies found.

32 Policies and procedures should be developed by people who have an understanding of the risks associated with HV switchgear and the specific system in which it is installed. Competent staff should implement the policies and procedures and review the effectiveness of the management system. If the expertise necessary to do this is not available in-house, someone should be developed to obtain this expertise, or assistance should be sought from others. Assistance may be obtained from:

- distribution network operators;
- electricity generators;
- switchgear manufacturers;
- switchgear maintenance providers;
- consulting organisations specialising in switchgear and HV training; and
- technical services companies.

33 The British Electrotechnical and Allied Manufacturers Association (BEAMA) can provide up-to-date details of manufacturers (see www.beama.org.uk).

Training and competence

34 People who are required to operate or maintain switchgear must be competent to do so. Being competent means having sufficient knowledge or experience to prevent danger or injury, or to be under such degree of supervision as may be appropriate for the nature of the work. Appropriate training must be given to enable such people to carry out their duties safely and without risk to health. It is also important that they understand the limits of what they are able to do, including tasks they must not undertake unless appropriately supervised. It is unlikely that attending a training course on its own will enable someone to demonstrate competence in all circumstances. Appropriate supervision may also be necessary. A number of organisations offer training courses, from general appreciation of site access and responsibilities through to detailed courses on operation, safety and maintenance practice etc. Training providers include:

- distribution network operators;
- switchgear manufacturers; and
- technical services companies.

35 To ensure that the different types of activity necessary when operating and maintaining switchgear are performed safely, it is useful to define levels of authorisation for people. This will enable a clear definition of the duties that are expected to be documented. It will also help the people who carry out work to understand the limitations of what they are authorised to do and what they should not do. For example, someone trained to close a circuit breaker as part of an

isolation procedure may not be authorised to close the same circuit breaker if it has operated due to the detection of a fault condition.

36 Typically, there will be a designated competent person or persons (also known in some industries as an 'authorised person' or 'senior authorised person', depending on their level of responsibility). The description 'competent person' (or 'authorised person') in the context of someone appointed to operate switchgear implies:

- a person appointed by the employer, preferably in writing, to undertake certain specific responsibilities and duties, which may include the issue and/or receipt of safety documents such as permits-to-work. The person must be competent by way of training, qualifications and/or experience and knowledge of the system to be worked on.

Operational safety documents

37 The implementation of a safety document scheme, generally referred to as a permit-to-work system, is recommended as part of a safe system of work for the use, care and maintenance of high-voltage switchgear. The naming of documents may vary between organisations, but most schemes will include three types of control document:

- limitation of access – issued to define the physical limits within which a work activity may be carried out, specifying any precautions necessary and hazards that may be present within the work area;
- permit-to-work – when issued, clearly identifies the equipment to be worked on, the work to be carried out and the actions taken to achieve the conditions which safeguard people working from the dangers which are inherent in an HV system. A permit-to-work should never be issued on equipment that is still live; it should only be issued when the measures required for safety have been completed; and
- sanction for test – issued to allow specified HV equipment to be tested, identifying the conditions under which the testing is to be carried out and the actions taken to safeguard the people performing the test, and anyone else who may have access to the area. A sanction for test may allow temporary earth connections applied as part of the protective measures specified for a work activity to be removed for the purposes of testing.

38 HV permits-to-work should not be used for general work control purposes. Further guidance on their use can be found in *Electricity at work: Safe working practices* and BS 6626.⁹

39 Everyone who is reliant on operational safety documents for their safety should be familiarised with the relevant procedures and made aware of their responsibilities. A permit-to-work should only be issued by someone who is competent and authorised to do so. Permits-to-work should only be given to people capable of understanding the precautions and limitations of the activity described on the permit. Ideally, a permit should be issued at the work location and the task clearly explained to the recipient before the permit is handed over. The recipient of a permit is responsible for ensuring that the safety precautions identified are adhered to, and that only the permitted work is completed, confined to the area defined in the permit. It is important that the recipient understands these responsibilities and is, to the best of their knowledge, satisfied that the precautions are adequate for the work they or their work group are about to complete when the permit is received. When work is to be carried out on HV switchgear or equipment, it is likely that those doing the work will need to be designated 'competent persons'.

40 Working alone should be avoided whenever possible. If the person issuing the permit will also be doing the work, it is strongly recommended that someone else makes an independent check of the control measures. It is important that the person doing the work follows the process of issuing and receiving the permit in full, even though it is their signature on both parts of the document. Following this process reinforces the requirement to consider the risks associated with the task and the identification of the safety precautions required. It also helps to confirm that the necessary precautions have been put in place before work begins. Accidents have occurred when experienced people have failed to implement the requirements of permit systems.

Network diagram

41 A network diagram (also referred to as a single line diagram) is a schematic representation of an electrical network identifying the interconnection of an electrical distribution system from the supply intake point(s) to the loads that it feeds. It provides an overview of the system and identifies all the switchgear and its location within the network. A network diagram is an important reference document for the operation and maintenance of an HV system.

42 The network diagram should include prospective fault current/energy values and information about the capability of switchgear. It is a useful way to record and communicate operational restrictions such as those created by the presence of overstressed equipment or DMO switchgear. It can also be used to identify the interaction of the LV system with the HV system, which is important if there are alternative sources of energy on the LV network.

43 A network diagram can be used to identify network configurations that may increase fault levels or other operations that need to be avoided to prevent danger. It can be used for the development of safe operating procedures. It can also help to identify the different types of equipment present on a network for which training may be required.

44 For all but the most simple distribution system, a network diagram is an important reference document for the planning, coordination and control of work activities. It should be accurate and up-to-date. Providing an up-to-date copy in each substation on a site with multiple substations can provide a useful reference, particularly during abnormal system conditions. In this situation, diagrams should be controlled through an appropriate management system to ensure they stay up-to-date.

Maintenance systems and asset registers

45 Many businesses use maintenance management systems for the scheduling and recording of maintenance work. Corporate requirements are likely to determine the choice of system used. Most maintenance systems will incorporate an asset register to identify all items of equipment that require maintenance. Asset registers can usefully be used to store and reference records relating to switchgear. A maintenance system can drive inspections and preventative maintenance processes based on the equipment identified in the asset register, ensuring that equipment is not overlooked. Some form of hierarchical structure is useful within an asset register to enable referencing on larger systems. Such structures need not be complex. There are legal requirements to maintain equipment so that it does not give rise to danger. Typical information in an asset register for an item of switchgear may include:

- physical location;
- manufacturer and type reference, including the standard to which the equipment was manufactured;

- serial number and year of manufacture;
- date of installation;
- voltage rating, current rating, fault rating;
- type of operating mechanism (dependent manual, independent manual, dependent power, independent power and stored energy);
- details of any modifications, eg fitted anti-reflex handles;
- type of electrical protection installed and details of the settings;
- references to the location of manufacturer's data sheets, drawings and operating and maintenance instructions; and
- references to the location of maintenance records and other history associated with the operation and use of the equipment.

Maintenance records

46 Records are a key part of an effective maintenance system. Keeping records provides confidence that maintenance has been completed and, when used with an asset register, can be used to verify that the maintenance of switchgear has not been missed. Measurements recorded during maintenance inspections are useful in determining switchgear performance, as trends in recorded values are often more valuable than specific, one-off measurements. Trends and historical data may be used to assess the effectiveness of a maintenance programme or justify chosen maintenance frequencies.

47 A maintenance record for an item of switchgear will typically include:

- the date on which the work was performed and confirmation of the item worked on;
- who performed the work and a schedule confirming what was done;
- any observations or comments made during the maintenance, including any recommendations for further work;
- the results of any tests or measurements taken, including a record of functional checks when completed; and
- a means of raising urgent or important findings that may mean intervention is required before the next scheduled maintenance period.

Operation of switchgear

Fault level and ratings

48 Electrical equipment must not be used where its strength and capability may be exceeded, unless it is used in such a way that nobody could be exposed to danger. Before operating any switchgear, you have to determine if the switchgear is capable of performing the duties expected of it. British Standards or other standards (see 'Further reading') relevant to the manufacture of switchgear may provide information about fault-handling capability. Details may also be found on the rating plate of the switchgear itself. System studies are likely to be required to determine the fault current/energy level at the specific point in a system where the switchgear is installed, although this may not be necessary if the rating of the equipment cannot be exceeded. Where switchgear was designed to now obsolete British Standards, reassessment of the rating by the original manufacturer or switchgear specialists may be necessary.

49 To determine the fault current/energy at each point in a network, it may be necessary to include the fault energy contribution from rotating plant such as large induction motors, synchronous motors and generators. Where practical, for more complex networks, fault current/energy calculations should be performed

for all possible configurations of the network, as fault levels are likely to vary depending on the network configuration. The distribution network operator (DNO) responsible for the supply from the public supply network has a legal obligation to provide, on request, the maximum short-circuit current at the incoming supply terminals (see the Electricity Safety, Quality and Continuity Regulations 2002, regulation 28).¹⁰

50 The calculation of fault current/energy is a specialist topic, and is likely to require support from people experienced in undertaking and interpreting such calculations. Many specialists use software modelling of electrical networks to determine fault levels.

51 The information from a fault current/energy study can be recorded on a network diagram and referenced against the known ratings of the switchgear. In this way, it is possible to identify and communicate the presence of overstressed switchgear and identify any network configurations that may lead to equipment becoming overstressed.

Effect of on-site generation and other large rotating machines

52 On-site generation and large rotating machines can have an impact on the duty required of switchgear. Both contribute to fault current/energy, and this must be taken into account when determining if switchgear is adequately rated. Where a network includes large machines, the following actions should be taken:

- check that the fault current/energy at the circuit-breaker(s) controlling generators and other large rotating machines is within the capability of the circuit-breaker(s), paying particular attention to older switchgear. If the capability of the switchgear is exceeded, then treat the circuit-breaker(s) as overstressed;
- provide equipment to ensure that generators and synchronous motors are synchronised before it is possible to close the controlling circuit-breaker(s). Attempting to close a generator or synchronous motor circuit-breaker or switch onto networks that are not synchronised can lead to overstressing and damage to the driven plant;
- estimate the effects of transient voltages that may be created in a network when clearing a fault being fed by a generator or by the inertia of large, rotating machines. If this exceeds the rating of the circuit-breaker(s), treat the circuit-breaker(s) as overstressed; and
- confirm whether the protection settings in use are appropriate for the situations when the generator is operating and when it is not operating. For guidance, refer to the Energy Network Association publication ER G59/3.¹¹

Reducing the risk of switchgear failure

Overstressed switchgear

53 Where switchgear has been identified as being overstressed, immediate precautions must be implemented for safety. These may include:

- preventing people gaining access to the area containing the switchgear while it is live (blast protection may be needed if access into the immediate area such as combined HV/LV rooms cannot be prevented);
- prohibiting operation of the switchgear unless it has been made dead;
- disabling automatic tripping of the switchgear. Protection elsewhere may need to be adjusted to ensure adequate levels of fault protection for the system; and

- reducing the fault current/energy, eg by operating transformers as single feeders rather than in parallel.

54 The immediate precautions are intended as short-term measures to be implemented for safety on determining that switchgear is overstressed. Unless the situation can be remedied, the switchgear must be replaced. Fault current/energy may be reduced by the installation of reactors or reconfiguration of the network. Where network configuration is critical to the safe operation of switchgear, interlocking should ideally be fitted to prevent overstressing. Being aware that equipment is overstressed, and failing to take action to prevent danger, is likely to be a breach of the law.

55 Where overstressed switchgear has to remain connected to a network while arrangements are made to resolve the issue, it is important to have confidence that the switchgear is in good condition. If there is doubt about its condition, it should be maintained in accordance with the manufacturer's instructions. While this action will not remedy the situation, it may lessen the risk of catastrophic failure while the switchgear is in use. In making the switchgear available for maintenance, the guidance given in paragraphs 53–54 should be followed and the switchgear must not be operated unless it has been made dead.

Dependent manually operated (DMO) switchgear

56 DMO mechanisms are generally found only on older types of oil and air circuit-breakers. The risks associated with the use of this type of switchgear have been described in paragraphs 24–26. Even in situations where the equipment is known to be in good condition and its use is restricted to appropriately trained people, its live operation creates a foreseeable risk of injury. Safety is dependent on the physical actions of the operator. Its presence on a live system makes it foreseeable that it may be operated live, despite procedures that may be in place intended to prevent its use. It is a requirement in law that all systems shall be constructed at all times so as to prevent, so far as is reasonably practicable, danger. In HSE's view, the presence of this type of equipment on a system is likely to lead to a breach of the law. DMO switchgear has not been manufactured for many years, and the dangers associated with its use have been widely publicised. It is HSE's opinion that this equipment should have been replaced with switchgear that does not have a DMO mechanism.

57 For some DMO switchgear, it may be possible to fit a power closing mechanism. Only power closing mechanisms specifically designed and approved by the original equipment manufacturer should be used. The equipment then ceases to have a DMO mechanism. Where power closing mechanisms can be or have been fitted, it is essential that the owner of the switchgear is able to determine the fault-handling capability of the modified equipment to ensure that the modified switchgear is not overstressed. The determination of the fault-handling capability of DMO switchgear manufactured before the 1960s is likely to be difficult to achieve. The fitting of power closing mechanisms to equipment of this age is unlikely to resolve all of the issues associated with its safe use, and it should be replaced.

58 If DMO switchgear is found to be present in a system, its operation and maintenance must be restricted to specifically trained people. There are few circumstances where it is acceptable to operate such equipment live. Even in such cases, it is advisable to operate the equipment only after it has been made dead. When DMO switchgear is to be closed, the recommended method of operation is:

- make the system dead upstream using a suitably rated switch or circuit-breaker;
- check, where practicable, the system beyond the DMO switchgear to ensure that it is fault-free;

- close the DMO switchgear to ON (while dead); and
- energise the system from the remote point, ensuring that no people are in the vicinity of the DMO switchgear.

59 Provided the DMO switchgear is not overstressed and the risks from its operation whilst live are reduced then, in the following circumstances only, live operation of the switchgear may take place subject to risk control measures being carried out:

- bus-section and bus-coupler circuit-breakers on a fully energised system (ie live both sides);
- circuit-breakers controlling circuits which have been tested immediately before closure; and
- where the DMO switchgear has recently been operated for the purpose of routine isolation, it may be reclosed manually, providing the electrical circuit it feeds has not been disturbed.

Fault clearance

60 Circuit-breakers should be inspected after clearing a fault before being put back into service. In some situations, such as auto-reclosing systems for overhead power line protection, a number of reclose operations may be permitted before the circuit-breaker is locked out. Following inspection, if a circuit-breaker shows any signs of distress, it must be maintained before being put back into use. Signs of distress include a smell of burning or ozone on entering the substation, the ejection of oil from the circuit-breaker if it is oil-filled, distortion of the tank or enclosure, signs of soot or sounds of electrical discharge or arcing. Where possible, the reason for the circuit-breaker tripping should be identified and dealt with before any attempt is made to reclose.

Care and maintenance of HV switchgear: Common requirements

61 HV switchgear must be maintained to prevent danger. Maintenance of high-voltage equipment is practical to achieve. Detailed guidance on the maintenance of HV electrical switchgear can be found in BS 6626.

62 The frequency and type of maintenance needed can be determined from an assessment of the risks, knowledge of the equipment, how frequently it is likely to operate, and the expectation for the reliability and availability required from the system. Typically, maintenance programmes will be time-based, condition-based, reliability-centred or use a combination of all three techniques. Whatever approach is used, it is important to investigate and learn from instances of equipment failure. An analysis of switchgear failures and the results of maintenance inspections can be used to determine if the chosen maintenance regime is delivering the required results, and can allow changes to be made based on evidence obtained.

Time-based preventive maintenance

63 The rigorous application of time-based schedules for switchgear maintenance has provided high levels of reliability, particularly with equipment used in distribution networks. Oil-filled switchgear was designed and introduced at a time when the predominant maintenance philosophy consisted of equipment overhauls at fixed time intervals. Manufacturers' recommendations typically formed the basis of a maintenance programme. This approach is suitable for all types of switchgear and not just oil-filled switchgear, but the operating requirements of the equipment

must also be considered. Where it is known that switchgear will be subjected to variable operating conditions or frequent duty, eg frequent motor starting, maintenance at fixed time intervals may not be adequate, and other techniques may be more appropriate. Evidence from the investigation of switchgear failures or the findings from equipment overhauls can be used to determine if a time-based approach is appropriate.

Condition-based maintenance

64 Condition-based monitoring using predictive maintenance methods can be used to determine when maintenance of switchgear is required. Careful assessment of the parameters to be monitored, the techniques for acquiring the condition data and, most importantly, an understanding of the degradation mechanisms affecting the switchgear are needed to justify the criteria on which the decisions to take action are based.

65 When considering moving to a condition-based maintenance approach, the options available should be carefully assessed. This should be done with the assistance of organisations with experience in this area, since the performance of switchgear is influenced by the electrical and environmental conditions under which it operates. Applying techniques and criteria from one industry sector to another, or even another area of a site, may not be appropriate as conditions may vary.

66 Diagnostic tests, both intrusive and non-intrusive, can be applied to switchgear. Tests may be undertaken during commissioning in order to establish a baseline for future comparison. Examples of diagnostic testing include partial discharge detection measurements, thermographic surveys, trip mechanism timing profiles, insulation resistance measurements, polarisation index calculations, partial discharge and loss angle/tan delta testing.

Partial discharge detection

67 Partial discharge (PD) measurements can enable an assessment of the condition of the insulation in high-voltage plant to be made. Non-intrusive techniques for performing PD measurements using portable instruments include:

- measurement of transient earth voltages (TEVs);
- ultrasonic detection; and
- radio frequency interference (RFI) detection.

68 Some surface discharges are better detected using ultrasonic detection equipment. In practice, a combination of 'TEV' and ultrasonics is generally used on indoor, metal-clad switchgear. RFI can be used to detect some advanced partial discharge activity, but the technique is limited in application. On strategically important switchboards, permanent partial discharge monitoring can be installed based on the TEV principle. It is important that, if reliance is being placed on these types of measurement, the people making the measurements understand how to correctly use the instruments and the correct interpretation is made from the measurements taken. There are a number of specialist service companies who can take PD measurements and provide interpretative guidance on the significance of the results.

Thermographic surveys

69 Thermographic surveys to identify the surface temperature of components can be undertaken using infra-red thermal imaging equipment or non-contact thermometers. One of the strengths of this technique is the ability to monitor equipment while in use. The techniques are useful for detecting overheating conductors, connections and hot fuses or circuit-breakers, but only in

circumstances where it is possible to safely gain access to make the measurements. Quartz glass viewing windows may be incorporated into equipment to allow external temperature measurement, although such modifications may affect the explosion containment capability of the enclosure in which they are installed. This technique has limitations with high-voltage, metal-clad switchboards where the risks associated with opening compartments and the potential for exposure to live parts must be carefully evaluated against the benefits and reasonableness of such actions. In most cases, if a hot component is detected, the equipment should be isolated to make a repair. Consideration must be given to undertaking inspections, with equipment isolated in the first place if risks are created by taking measurements live. Industry guidance is available on completing thermographic surveys.¹²

Mechanism timing tests

70 Many problems with circuit-breakers are attributable to damage of the mechanical parts or 'stiction' in the tripping mechanism. This results in a failure of the circuit-breaker to open or close, or be slow opening. Detection of a problem in a mechanism may not be possible through invasive maintenance, but potentially can be detected by timing tests. Trip-profile measurements provide a detailed assessment of mechanism performance and are a valuable, additional test that can be incorporated into the routine trip-testing procedure. When used immediately before intrusive maintenance, trip testing can give an indication of the adequacy of the maintenance frequency.

71 A number of instruments for performing mechanical timing tests are available on the market, and specialist switchgear maintenance providers can offer a testing and assessment service.

Reliability-centred maintenance (RCM)

72 RCM can assist in the process of determining a maintenance strategy by analysing the maintenance tasks in a structured way to determine the maintenance requirements of an item of switchgear in its operating environment. It does so by taking account of plant usage and condition, the causes and consequences of failure, and the required performance standards of the organisation.

Switchgear availability

73 It can be difficult for HV switchgear to be made available for maintenance. If there are scheduled shut-down or closure periods, maintenance may become time-based, with the interval for maintenance determined by the shut-down frequency. Provided the intervals between maintenance are no greater than the manufacturer's recommended maintenance intervals, or the interval determined through an assessment of the duty of the equipment, this situation should be acceptable. Predictive techniques may be used to determine the extent of work required and minimise outage time. For organisations where a loss of power cannot be tolerated, redundant configurations of switchgear need to be employed to enable maintenance to take place. The potential difficulty of arranging for equipment to be made available for maintenance is not a justification for a failure to complete adequate maintenance.

Trip-testing

74 Trip-testing of circuit-breakers (taking action to make a circuit-breaker trip) is a simple operational test that 'exercises' the mechanism of the breaker and gives confidence that it will operate when required to do so. Annual trip-testing is undertaken by many users and, when combined with tripping via the protection

scheme, should confirm the satisfactory (or otherwise) operation of the tripping circuit. Careful movement of the disc in mechanical relays or specific command inputs into electronic relays can be used to simulate a trip condition and make a circuit-breaker trip.

Protection testing

75 Periodic testing of the protection relay scheme is a separate requirement to the maintenance of switchgear, and is needed to ensure the integrity of a system. It is not always carried out when the switchgear is maintained and requires specialist knowledge and equipment to complete. The type of testing required and frequency with which it is completed will depend largely on the type of protection equipment installed, the purpose of the testing and the consequences of protection failure. Electronic relays often incorporate self-diagnostic features and may be configured to generate alarms if faults are detected. Further guidance is provided in paragraphs 137–142.

Tests to be undertaken following maintenance

76 Before being returned to service, switchgear should be subjected to an operational check to ensure as a minimum correct close and open operations. Reference should be made to the manufacturer's instructions. Testing should also include checking that interlocks, position indicators, indicator lamps, local (and remote, if applicable) trip indications, trip counters and other associated devices are working correctly.

77 Automatic circuit-breakers should be tripped using the protection system to test the complete tripping circuit and verify that the reclosing mechanism is functioning correctly.

Routine inspection of substations and switch rooms

78 Switchgear is generally located in substations or switch rooms that may be visited infrequently. Depending on the risk, access should be restricted to specific people such as designated competent or authorised persons. One way to achieve this is by keeping doors locked and controlling access to the keys. Routine inspection is necessary to ensure deterioration has not occurred to the switchgear, any ancillary equipment or the building fabric which may have an adverse effect on the switchgear environment. Where defects are found which have the potential to give rise to danger, they must be dealt with. Minor defects should also be rectified to prevent dangerous situations from developing. Recording visits and any actions taken is a useful way to ensure that inspections are being completed and to identify trends. When undertaking an inspection, you should be aware of any signs of abnormal conditions that may give rise to danger.

Signs of abnormal conditions

79 A check for abnormal conditions should be carried out immediately on entering a substation or switch room. Persons authorised to enter a substation or switch room must have an understanding of what to look for. If any danger is suspected, the inspection should be aborted and an investigation carried out by someone who has the necessary knowledge and experience to be able to determine what actions may be necessary. Typical warning signs are:

- high temperature in the building;
- presence of smoke;
- smell of 'hot' substances (oil, compound etc);

- audible discharges or arcing;
- smell of ozone;
- nauseous odour (potentially indicative of a release of SF₆);
- signs of leaked oil in the vicinity of oil-filled equipment;
- signs of fresh compound leaks; and
- distortion of, or evidence of soot on enclosures.

80 The use of hand-held partial discharge equipment may be considered for use as an additional safety measure during a routine inspection or when entering a substation. The detection of the early onset of potential faults through the use of such equipment can reduce the risks to people who perform inspections by providing a warning that something may be wrong.

Equipment environment

81 During a routine inspection, the fabric of the substation or switchroom building should be examined to confirm that:

- there are no signs of water ingress;
- the building is clean, tidy and not being used as storage space;
- services such as lighting and telephones are working;
- doors and windows are secure and, where required, locked;
- there are no signs of damage or unwanted interference with the equipment or building;
- the building is not overgrown with vegetation, and access is acceptable; and
- there are no signs of rodent activity.

82 Routine inspection of outdoor switchgear compounds is also necessary to identify deterioration, damage or unauthorised access.

Visual examination of switchgear

83 During routine inspections of switch rooms and substations, switchgear should be examined to check:

- for signs of corrosion, oil leaks, or leaking compound;
- for the presence of earthing connections and other copper connections that may have been removed without affecting the immediate operation of the equipment;
- for evidence of water ingress into the equipment enclosures;
- that signs that ammeters, voltmeters, operation indicators, protection equipment indicators or flags, oil level or gas pressure (where sight glasses or gauges are fitted) appear to be operating and are displaying acceptable values;
- that protection equipment indicators or flags have not dropped to indicate warnings; and
- that labelling, padlocks and key exchange interlocks are present.

General services

84 Inspections should be carried out of substation lighting, including emergency lighting, tripping batteries, heaters, battery chargers, control panels, fire detection and extinguishing systems, and the telephone line, if fitted for emergency purposes. It is also useful to check for the presence of an up-to-date network diagram, substation log book and tools such as winding handles, circuit breaker lifting trolleys, test spouts or earthing equipment. Some of these items may also require a more formalised inspection (see paragraphs 131–135).

85 Battery systems may be fitted with test facilities to indicate battery condition. Where fitted, they should be used to test battery condition. Some protection devices may provide information regarding unusual conditions which have occurred on the network but not resulted in a trip. Recording this information can be useful, particularly where condition-based maintenance is being used.

Circuit-breakers subject to special duty

86 Circuit-breakers that regularly interrupt large load currents such as those controlling arc furnaces or frequently operated motors will require more frequent maintenance than circuit-breakers on normal distribution duty. The degree of maintenance will depend on the nature of the duty being performed in relation to the rated capability (electrical and mechanical) of the circuit-breakers and the frequency with which they operate. Recording information from the operation counter can be useful in assessing this. Particular attention should be paid to monitoring the rate of contact/arc control device deterioration, oil carbonisation and, where applicable, mechanism wear.

87 Where circuit-breakers operate frequently, it is possible that the rating of the circuit-breaker may be reduced after completing a number of operations. Guidance should be sought from the manufacturer of the equipment. Where frequent switching operations are likely to be required, the use of contactors rather than circuit-breakers is likely to reduce the requirements for maintenance, although such devices may not provide a suitable means of isolation.

Disposal issues, post-maintenance

88 Anyone who produces, treats, keeps, stores, transports or disposes of waste, including insulating oil and equipment that may be contaminated with SF₆ gas, must comply with the relevant requirements for the disposal of such waste. In England this is regulated by the Environment Agency, in Scotland by the Scottish Environment Protection Agency and in Wales by Natural Resources Wales.

89 Some capacitors and transformers may contain polychlorinated biphenyls (PCBs). The disposal of this type of equipment or oil that may be contaminated must only be carried out having taken into account the harmful effects and the legal requirements for the disposal of these potentially hazardous materials or substances. Advice should be sought from companies who have the necessary experience and facilities to be able to deal with these types of materials.

Care and maintenance of oil-filled switchgear

90 Examples of the arrangements of oil-filled switchgear are shown in Appendix 1 Figures 6, 7, 9, 10 and 11. If oil-filled switchgear fails, it has the potential to cause an explosion that may cause extensive damage to the switchgear and surrounding buildings, and serious injury or death to people, if present. The main failure modes for oil switchgear are:

- faults within oil compartments;
- failure of oil circuit-breaker to trip (which may result in an extended disconnection time due to fault clearance by upstream equipment); and
- solid insulation faults (external to oil compartments).

91 Faults within the oil compartment can result from:

- contaminated insulating oil;

- poor maintenance of the arc interruption system (contacts and arc control devices);
- breakdown of solid insulation;
- making or breaking fault current above the rated capability (in the case of a circuit-breaker); or
- internal component failure.

92 Actions that should be taken to minimise the risk of catastrophic failure include:

- external inspection (non-intrusive) to identify signs of abnormal condition detectable by sight, smell and sound to a person familiar with the appearance and expected condition of an item of switchgear;
- maintenance (intrusive) – a detailed inspection and examination requiring dismantling of the equipment to identify possible mechanism defects, insulating oil contamination and deterioration, erosion of contacts and arc control devices; and
- condition monitoring and assessment by partial discharge techniques – the detection and location of deterioration of solid insulation through the use of a partial discharge measuring device. Such devices can record electrical discharge activity, which gives an indication of insulation condition from the outside of live, high voltage equipment.

Maintenance procedures

93 Maintenance of oil-filled switchgear should include a thorough internal examination of circuit-breakers and switches. Maintenance should include:

- examination and cleaning of the tank interior, internal mechanism, contacts, arc control devices, bushings, phase barriers and tank lining;
- dressing, refurbishing or replacing main/arc contacts if found to be necessary;
- assessment of contact alignment using the circuit-breaker slow-close facility;
- cleaning of arc control devices, or replacement if burnt or worn beyond acceptable tolerances (cross-jet pots, turbulators etc);
- replacement of insulating oil with new, reclaimed or reconditioned oil (it is often more efficient to plan for oil replacement during maintenance than to undertake oil analysis to confirm the suitability of the insulating oil during the inspection);
- lubrication of operating mechanism and adjustment where required;
- replacement of seals and gaskets as recommended in the manufacturer's maintenance instructions, clearing vents and checking indicator windows;
- examination of primary isolating contacts for damage, burning and corrosion – cleaning and refurbishing (as necessary);
- checking and lubrication of the oil circuit-breaker isolating mechanism;
- checking correct function of position indicators and interlocks;
- checking shutter operating mechanisms as appropriate and where safe to do so;
- examining inside of cable termination chambers and current transformer chambers, as appropriate;
- examining and checking voltage transformer (as required and where safe to withdraw);
- secondary injection testing on circuit-breaker protection system, or, if this is not scheduled, carry out manual trip-test;
- on fuse switches/switch fuses, trip-testing with an appropriate fuse trip-testing device;
- examination of secondary contacts, wiring and auxiliary switches; and
- checking the truck goes fully into position and switchgear is level as appropriate when putting back into service.

94 Only remove tank covers for the minimum time necessary when maintaining oil switches, fuse switches and ring main units, and replace immediately after the work

is completed. This will minimise the risk of contamination of the tank interior by moisture, airborne particulates, dust, insects and vegetation (if outdoors). Care should be exercised when emptying and replenishing oil to minimise the risk of contamination of the new with the old.

Frequency of maintenance

95 Carrying out intrusive maintenance on oil-filled switchgear can introduce risks. Undertaking maintenance more often than is necessary can increase exposure to those risks. The risks associated with completing maintenance must be balanced against the legal requirement to maintain equipment so that it remains safe, and the need for maintenance for operational reasons. In doing so, it must be considered that:

- errors can be made during maintenance, leaving the equipment at greater risk of failure than if the maintenance had not been carried out; and
- switching is required to release the equipment for maintenance – the risk of a failure for switchgear is greatest during a switching operation.

Cleaning and inspection of oil-filled chambers

96 Oil-filled chambers should only be cleaned using proprietary wipes or synthetic sponges. It is extremely important that wipes should not release fibres, as failures have occurred due to the contamination of oil by fibres. Suppliers of cleaning products and switchgear manufacturers can provide advice on appropriate types of wipes and their performance.

97 Care is needed to avoid tearing sponges, which can allow small fragments to be introduced into chambers. Using disposable gloves and overalls can minimise the potential for fibre contamination.

98 Trace contaminants in insulating oil, such as acids, peroxides and moisture, can cause the switchgear plating metals (eg zinc and cadmium) to form metal salts and soaps, resulting in the degradation of both the plating surfaces and the oil.

99 Zinc and tin platings can degrade and form a large number of small 'whiskers'. For switchgear with tin- and/or zinc-plated components, particular care should be taken to check components for whiskers immediately following the removal of the oil. Remove any whiskers with an oil-soaked wipe, and then dispose of the wipe.

100 The phosphated coatings of steel components in switchgear are known to degrade in service, resulting in the presence of loose, phosphorous-rich particles contaminating the oil and coming to rest on the horizontal surfaces of the tank and other components, including bushings and insulators. Switches that contain phosphated components should be rigorously cleaned to remove contamination from insulating surfaces. Coated components should also be thoroughly cleaned to reduce the rate of recontamination of the oil.

101 Cadmium from the plating of mechanism metalwork can react with oil and moisture to form a cadmium soap, leading to the degradation of the plating surfaces and the oil. Cadmium soaps on the surface of solid insulation may lead to electrical degradation of the insulation. To prevent degradation, insulator surfaces should be cleaned with an appropriate solvent. Cadmium and cadmium compounds are highly toxic substances and need to be handled safely. For more information, see *Cadmium and you: Working with cadmium. Are you at risk?*¹³

102 Where oil is particularly contaminated, all components which have been in contact with the oil should be rigorously inspected to check for signs of corrosion, tracking, delamination or other degradation. Degraded components should be replaced. Densified wood laminate and pressboard are most susceptible to degradation if water has been present in the oil. Examination of these components may not reveal if they have a high moisture content, and insulation resistance measurements are recommended to establish their fitness for continued service. Guidance from the manufacturer may need to be sought to establish a suitable test method and determine the acceptable pass levels for insulation resistance measurements.

103 Fungal growth can occur in insulating oil that contains free water. The growth occurs at the interface between water from below and the carbon compounds from above. While it is rare to find fungal growth in insulating oil, any occurrence needs to be dealt with because, as the fungus grows, the oil is degraded, producing more water, various volatiles and acidic conditions that can cause corrosion. The production of water and resultant corrosion of materials in contact with the oil will also reduce the insulating properties of the oil.

104 The most common fungal growth in insulating oil is *Cladosporium Resinae*, whose spores can be airborne. They can lay dormant for periods of time and germinate when adequate moisture becomes available. Growth of the fungus from germinated spores can occur in a temperature range of -25 °C to +40 °C. Biocides can be used to kill the spores, and it is important to eradicate them because, if they are not destroyed, the fungal growth is likely to reoccur.

Tank cleaning techniques

105 To clean inside the tanks associated with oil-filled switchgear, once the old oil is removed, all accessible parts should be sprayed with clean oil under pressure. This now dirty oil should then be removed using a liquid vacuum cleaner, and the process repeated after examining the interior of the tank to determine if all the contamination has been removed.

106 Spraying is likely to create an oil mist, so suitable personal protective equipment must be worn to prevent the inhalation of oil. It is possible that the residual oil or sludge in a tank will contain cadmium as a result of the degradation of plated components which have been immersed in the oil. This presents a particular health risk to those cleaning the tank. In addition to respiratory protection, oil-resistant, disposable overalls, gloves and fitted safety goggles should be used. Workers need to be made aware of the hazards of ingestion of cadmium, and that good personal hygiene is needed after handling dirty oil and before eating.

107 Separate pumps and hoses should be used for removing and refilling equipment with oil to avoid contamination. Pumps and hoses used for clean oil should be dedicated to this purpose.

Insulating oil

108 The reliable performance of oil-filled switchgear depends on the characteristics of mineral insulating oil. Oil must be tested before being introduced into equipment, even if new, to ensure that it meets the required level of performance.

109 Laboratory assessments of oil samples taken from switchgear can provide information on the condition of both the switchgear and the oil. The results can be used to assess the effectiveness of a maintenance programme. Guidance on the

monitoring and maintenance for mineral insulating oils in electrical equipment is provided in BS EN 60422:2013.¹⁴

110 Oil taken from HV electrical equipment can be reclaimed. Oil companies have quality assurance/quality control procedures, which are intended to maintain acceptable quality and performance of reclaimed oil when it is supplied back to users. Switchgear oil may contain polychlorinated biphenyls (PCBs), so the procedures for handling used oil must take account of the procedures for PCB-contaminated materials or substances. For more information, see:

- EU Directive 96/59/EC The Disposal of Polychlorinated Biphenyls and Polychlorinated Triphenyls;¹⁵
- Statutory Instrument SI 2000 No 1043 The Environmental Protection (Disposal of Polychlorinated Biphenyls and other Dangerous Substances) (England and Wales) Regulations 2000;¹⁶
- The Environmental Protection (Disposal of Polychlorinated Biphenyls and other Dangerous Substances) (Scotland) Regulations 2000.¹⁷

111 In the UK, there are statutory requirements for the disposal of waste products. These make the holder of the waste responsible for its fate even after it has left their premises. In cases of doubt, consult the Environment Agency in England, the Scottish Environment Protection Agency in Scotland or Natural Resources Wales in Wales. These waste products include the oil removed from the switchgear (which may contain cadmium or cadmium sludge), and any new oil or solvent used to clean the components within the tank. All wipes, gloves or clothing which have come into contact with the cadmium should be collected and sealed in suitable containers labelled as special waste.

Post-fault maintenance of oil-filled circuit-breakers

112 Oil-filled circuit-breakers should be maintained as soon as possible after they have either been closed onto a fault or have operated automatically to disconnect a fault. Some organisations will inhibit the automatic tripping of a circuit-breaker after three operations on fault until maintenance has been completed. Care should be taken to distinguish tripping due to mal-operation of protection systems or inter-tripping for safety reasons from fault clearance so as not to force unnecessary maintenance of equipment. Post-fault maintenance should consist of:

- inspection and cleaning of all insulation within the tank to eliminate carbon, metal vapour/particle contamination;
- restoration of the contacts and arc control devices to an acceptable condition (including a check on contact alignment by slow-closing the oil circuit-breaker);
- replacement of the insulating oil; and
- inspection of the tank, tank gaskets and tank internal mechanism for signs of damage or distortion.

113 Where provision is made in the design for venting, this should be checked to ensure that the vents are not obstructed and any seals are intact and functioning.

Care and maintenance of non-oil switchgear

General guidance

114 Non-oil switchgear makes use of air, sulphur hexafluoride (SF₆) or vacuum as the interrupting medium. In some designs, vacuum interrupter bottles are housed within SF₆ chambers. An example of an arrangement of a vacuum circuit-breaker is

given in Appendix 1 Figure 8, an SF₆ insulated vacuum circuit-breaker is in Appendix 1 Figure 13, and an air circuit-breaker is in Appendix 1 Figure 12.

115 The sealed envelopes of SF₆ and vacuum switchgear improve reliability by removing the potential degradation of the interrupting medium due to adverse environments such as those containing dust, moisture etc. This has led to the introduction of the terms 'low maintenance' or 'reduced maintenance' for such switchgear. This does not mean that this equipment is maintenance-free; failures do occur, and inspection and maintenance procedures are required.

Maintenance procedures: Vacuum switchgear

116 Vacuum bottles may need re-certification or replacement after a specified operating life. Typically, the design life expectancy quoted by manufacturers is 20 years, although vacuum equipment of this age and older can be found in use. Testing during maintenance may identify a failed vacuum bottle, but is unlikely to provide information about the continued fitness for purpose of a bottle that does not fail the test. It is possible for a bottle which has lost vacuum while in use to remain in service under normal load conditions with no obvious signs of defect. Failure is likely only if the device is switched or required to break a heavy load or fault current. Failure is likely to be catastrophic.

117 Owners of vacuum switchgear should be aware of the design life expectancy of their equipment. While the equipment does have a high level of reliability, it cannot be assumed that this level of performance will be maintained indefinitely, or that extension to life is justifiable solely on failure rates experienced while operating the equipment within the manufacturer's design life expectancy. There must be a strategy in place to manage the risks associated with the potential for loss of vacuum when equipment reaches the limit of its design life expectancy.

118 X-rays may be generated when the open contact gap of vacuum switchgear is stressed at high voltage. High-voltage tests can be used to verify that vacuum is present, there being no other indication of the presence of vacuum within a bottle. There are no harmful emissions at normal service voltage. If a high-voltage pressure test is carried out with the switchgear in an open position, X-rays may be generated. Guidance should be sought from the applicable standards and the manufacturer.

119 Maintenance activities for vacuum switchgear should be based on manufacturers' recommendations, but are likely to include:

- inspection of the external condition;
- verification of the design life expectancy of the vacuum bottles and a check to determine the age of the equipment being maintained (note design life expectancy);
- measurement of contact wear where a measurement method is available;
- measurement of contact resistance when closed;
- a check on the vacuum integrity, eg by a high-voltage pressure test (X-ray risk);
- inspection, adjustment and lubrication of mechanisms, including shutters, where appropriate;
- on withdrawable equipment, examination of primary isolating contacts for damage, burning or corrosion – cleaning and refurbishing (as necessary);
- on withdrawable equipment, checking and lubrication of circuit-breaker isolating mechanism;
- checking correct function of position indicators and interlocks;
- examining the inside of cable termination chambers and other chambers as appropriate – removal of surface contamination from accessible solid insulation (where applicable);

- checking the operation and integrity of any automatic earthing facility, where applicable;
- examining and checking the voltage transformer, as required;
- secondary injection testing on circuit-breaker protection systems or the use of proprietary electronic simulation devices (or, if this is not scheduled, carry out manual trip-test); and
- examination of secondary contacts, wiring and auxiliary switches.

Maintenance procedures: Air-break switchgear

120 Maintenance work should be based on manufacturers' recommendations, but is likely to include:

- inspection of the external condition;
- examination of main/arcing contacts for excessive burning/damage. Recondition or renew as required, taking account of manufacturer's requirements for different contact construction and materials;
- checking/adjusting spring contact force and contact alignment, as required;
- removal, examination and cleaning of the arc chutes – renew if damaged or eroded;
- inspection, adjustment and lubrication of mechanisms, including shutters, where appropriate;
- on withdrawable equipment, examination of primary isolating contacts for damage, burning or corrosion – cleaning and refurbishing (as required);
- on withdrawable equipment, checking and lubrication of circuit-breaker isolating mechanism;
- checking correct function of position indicators and interlocks;
- examining inside of cable termination chambers and other chambers as appropriate – removal of surface contamination from accessible solid insulation (where applicable);
- examining and checking voltage transformer (as required);
- secondary injection testing on the circuit-breaker protection system (or, if this is not scheduled, carry out manual trip-test); and
- examination of secondary contacts, wiring and auxiliary switches.

Maintenance procedures: SF₆ switchgear

121 With SF₆ switchgear, a significant proportion of known problems are associated with loss of gas through defective/worn seals. Maintenance activities should be based on manufacturers' recommendations, and are likely to include:

- inspection of the external condition;
- checking of gas pressure;
- if 'topping up' of the gas is necessary, then refer to precautions in the following section;
- inspection, adjustment and lubrication of mechanisms (including shutters, where appropriate);
- on withdrawable equipment, examination of primary isolating contacts for damage, burning or corrosion – cleaning and refurbishing (as required);
- on withdrawable equipment, checking and lubrication of circuit-breaker isolating mechanism;
- checking correct function of position indicators and interlocks;
- examining the inside of cable termination chambers and other chambers as appropriate, with removal of surface contamination from accessible solid insulation (where applicable);
- examining and checking the voltage transformer (as required);

- secondary injection testing on the circuit-breaker protection system (or, if this is not scheduled, carry out manual trip-test); and
- examination of secondary contacts, wiring and auxiliary switches.

SF₆ gas handling and safety precautions

122 Under normal conditions, SF₆ gas remains inside switchgear, and any decomposition products formed during interruptions are neutralised by molecular sieves and natural recombination processes. SF₆ can be released at all stages of the equipment life cycle, and procedures for dealing with the effects of a release are required. A warning notice must be posted inside the substation clearly stating this.

123 During maintenance, refilling, condition testing and end-of-life disposal of the gas, precautions must be taken to minimise the risk of releasing gas to the environment and prevent exposure to potentially harmful substances that may form within switchgear. Procedures for dealing with accidental release due to equipment failure must be in place. Advice, training and support can be obtained from equipment manufacturers, SF₆ gas suppliers, and other organisations with experience of operating and maintaining this type of equipment.

Release of SF₆

124 SF₆ is a greenhouse gas and control over its use is essential. It must not be deliberately released into the atmosphere:

- SF₆ should be recycled and re-used to the maximum possible extent;
- losses of SF₆ from electrical equipment must be minimised;
- all new SF₆ equipment should allow for recycling; and
- recycling procedures should be formulated.

Hazards

125 Procedures for safe handling of SF₆ are available from a number of sources, including BS EN 62271-4:2013,¹⁸ ENA Engineering Recommendation G69¹⁹ and manufacturers.

126 SF₆ in its pure state is inert, colourless, tasteless, non-flammable and non-toxic. It is heavier than air, and can accumulate in cable trenches, pits and tunnels. A volume greater than 19% in the air may cause asphyxiation. An appropriate risk assessment should be undertaken in order to determine if cable trenches/tunnels are classified as confined spaces, in which case appropriate control measures for access must be implemented.

127 By-products are generated by the decomposition of SF₆ when exposed to an electric arc. Decomposition may lead to the presence of a white powder. This powder is irritating to the skin, eyes and respiratory mucous membranes. Users of switchgear containing SF₆ must be aware of the risks and have in place procedures to cover:

- emergency situations – release of SF₆ gas;
- scheduled maintenance of contaminated SF₆ equipment involving access to the SF₆ compartment;
- testing SF₆ gas and filling procedures;
- possible contamination in areas surrounding the switchgear; and
- storage, transport and disposal of contaminated gas.

128 The presence of small quantities of decomposition products is accompanied by a pungent and unpleasant odour. Irritation occurs within seconds, well in advance of any dangers arising from poisoning.

129 Where work is necessary which involves contact with equipment contaminated through contact with SF₆ or its decomposition products, the following precautions should be taken:

- use disposable protective overalls;
- maintain a high standard of personal hygiene;
- do not eat, drink or smoke;
- avoid cleaning nose, eyes or face other than with clean paper tissues;
- clean off any decomposition products from the work area, clothing and equipment;
- dispose of protective overalls in an approved manner; and
- wash all exposed parts of the body as soon as possible after leaving the working area.

Sampling

130 The majority of switchgear up to 33 kV uses sealed containment with the SF₆ gas at a small, positive gauge pressure (typically 0-1 bar gauge). The equipment is assembled, filled with SF₆ and tested in the factory, and no further handling of the gas is expected during its operating life. There may be occasions where sampling and testing of the gas is required. Gas removed from switchgear for sampling should be treated as contaminated. Guidelines for assessing the quality of SF₆ gas are available in BS EN 60376:2005.²⁰ This also provides guidance on the quality of gas to be used for topping up switchgear.

Care and maintenance of ancillary equipment

Test probes

131 Serious incidents have occurred involving failings with portable test probes. These items must be included in an inspection and maintenance programme. Incorporating them into an asset register so that routine inspection is scheduled and recorded should ensure that they are not overlooked. Use of a safety colour-coding procedure or some other method to indicate the current period of use will ensure that probes that have not been maintained are not inadvertently used. Test probes should be stored in clean, dry containers when not in use. Checks should include:

- inspection of general condition, damage and deterioration;
- inspection for correct and legible identification;
- cleaning to remove oil films and loose dirt (using wipes that do not release fibres);
- inspection of contacts for wear, burning or other signs of abnormal condition, and to ensure they are securely attached;
- inspection of bushings for cracks, damage, burning etc;
- inspection of any guide pins, interlocking tabs and locking bolts to ensure they and any other parts are securely attached;
- measurement of the insulation resistance using an insulation tester, and comparison against an agreed pass figure;
- for those probes which are shown to be in satisfactory condition, mark with the correct code for the current period of use; and
- removal of any damaged or defective probes from use, and initiation of repair or replacement.

Earthing equipment

132 Earthing equipment for switchgear can be categorised as:

- integral – part of the permanent operating mechanism of the switchgear;
- extensible – a system of probes that can be attached to a circuit-breaker truck which is then racked into an earth position; or
- portable – a system of probes for insertion into the switchgear and leads for connection to a suitable earth point by flexible cables and clamps.

133 The following recommendations are applicable to the care and maintenance of extensible and portable earthing equipment. The maintenance of integral earthing systems should be incorporated as part of the maintenance regime of the switchgear itself.

134 Portable and extensible earthing equipment are vital pieces of safety equipment. Like test probes, they should be inspected on a regular basis and included in an asset register. The use of a safety colour-coding procedure or other system to indicate the current period for use will help ensure that equipment which is outside that period is not inadvertently used.

135 Checks should include:

- inspection of general condition, specifically to identify damage or deterioration;
- inspection for correct and legible identification;
- cleaning as required;
- inspection of contacts, connections and leads for wear, burning or other signs of abnormal condition, and to ensure they are securely attached;
- inspection of all insulation components for damage;
- inspection of any guide pins, interlocking tabs and locking bolts to ensure they are present, functional and secure;
- for earthing equipment which is shown to be in satisfactory condition, mark with the correct colour code for the current period of use; and
- removal of any damaged or defective earthing equipment from use, and initiation of repair or replacement.

Assessment of aged switchgear

136 Since the risk of catastrophic failure increases with age (especially oil switchgear), a process of assessment should be used to decide on the appropriate action for dealing with aged switchgear in service. Such an approach should incorporate condition assessment. This will enable decisions to be made on whether to retain, refurbish or replace aged switchgear and allow investment to be directed to best effect. Decisions should be made on the basis of condition and on the potential risk of leaving individual switchboards in service. The decision-making process follows the assessment actions displayed in Figures 1–5.

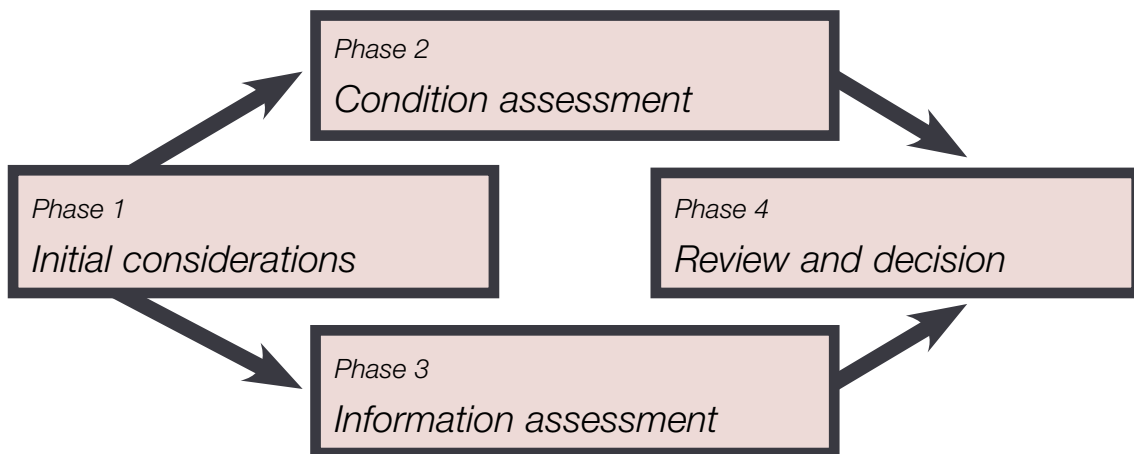

Figure 1 Assessment process overview

Notes:

- (a) If the switchgear has either a DMO mechanism or, in the case of oil circuit-breakers, plain break contacts (ie no arc control system), it should be scheduled for replacement (or upgrading, if practicable).
- (b) If the calculated fault current/energy at the switchboard exceeds the switchgear capability and there is no possibility of reconfiguring the network to reduce the fault current/energy, usually the only viable option will be to replace the switchgear.

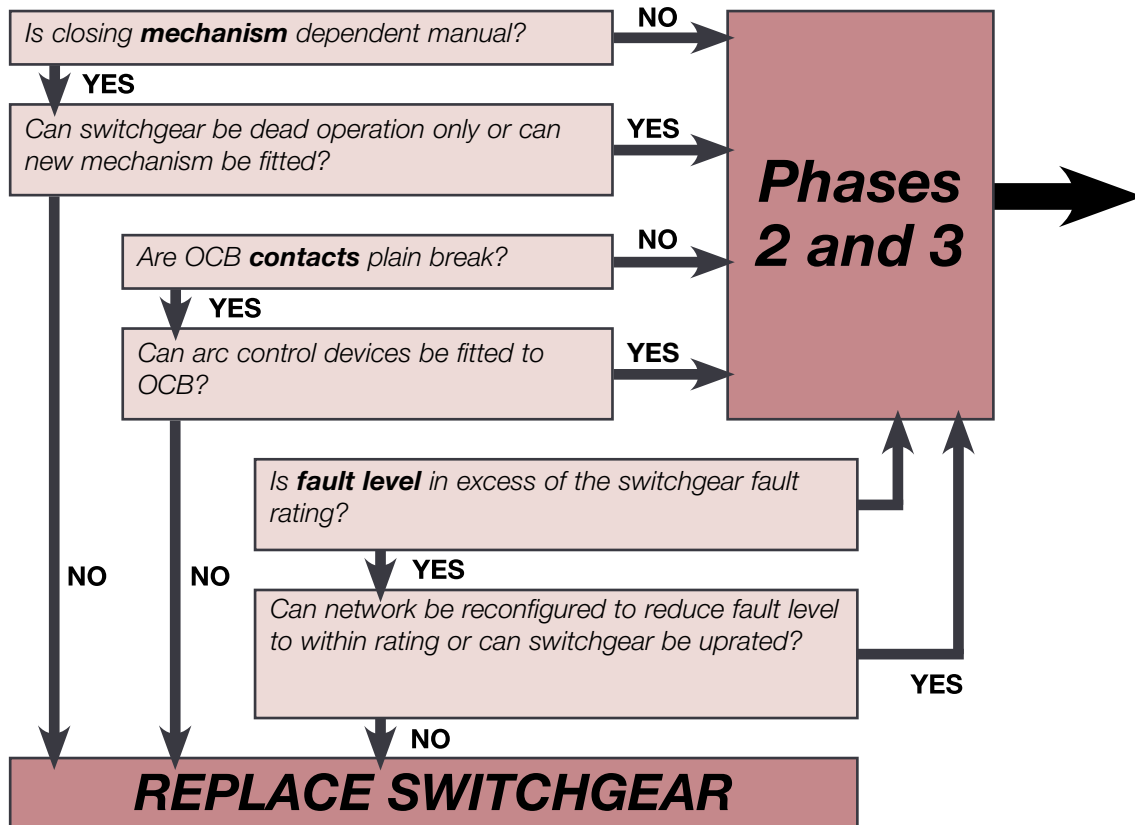

Figure 2 Phase 1: Initial considerations

Notes:

- (a) If the switchgear has either a DMO mechanism or, in the case of oil circuit-breakers, plain break contacts (ie no arc control system), it is strongly recommended that it be scheduled for early replacement (or upgrading, if practicable).
- (b) If the calculated fault current/energy at the switchboard exceeds the switchgear fault capability and there is no possibility of reconfiguring the network to reduce the fault current/energy, then usually the only viable option will be to replace the switchgear.

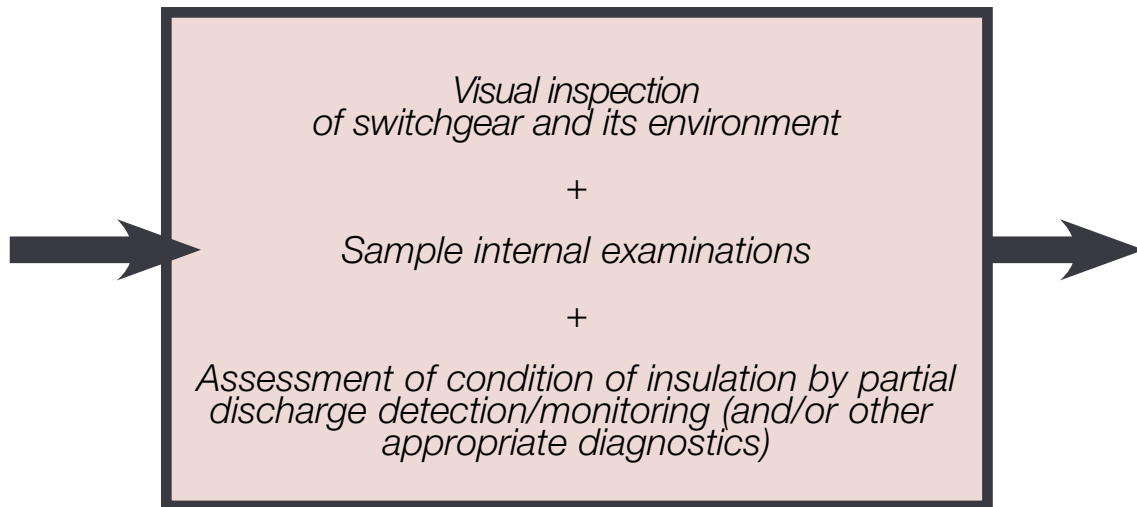

Figure 3 Phase 2: Condition assessment procedures

Notes:

(a) If the switchgear is not to be replaced as a result of the Phase 1 considerations, it will be necessary to carry out condition assessment in order to establish the suitability of the switchgear for continuing service. The condition assessment should embrace a mixture of external and internal examination, together with appropriate diagnostic tests to ascertain the condition of HV insulation.

(b) Information on diagnostics for assessing insulation condition is provided in paragraphs 67–71.

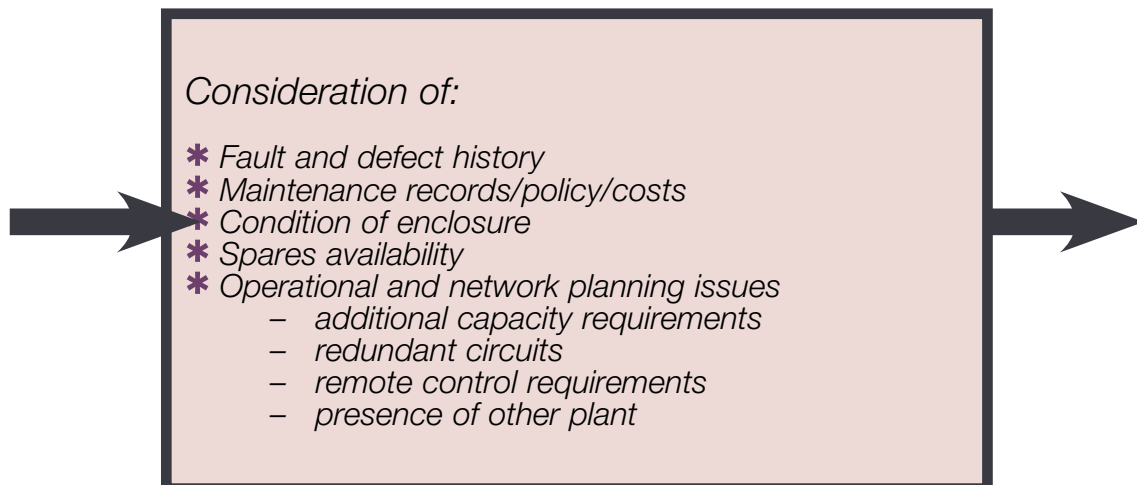

Figure 4 Phase 3: Information assessment

Note:

The above information needs to be acquired from the appropriate sources and assessed.

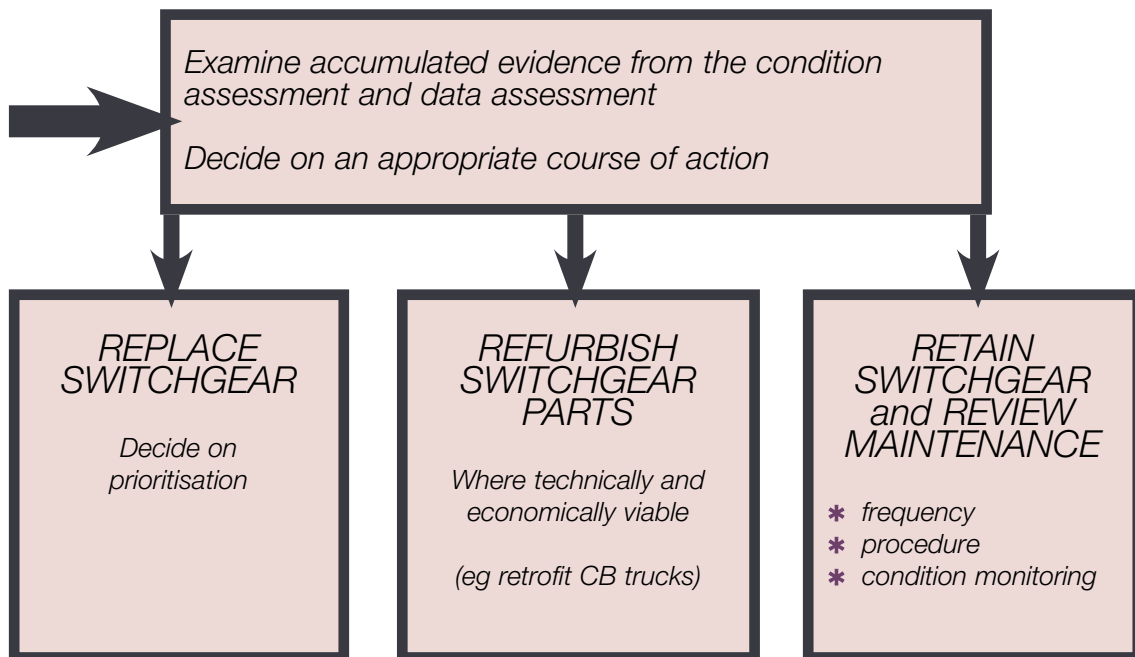

Figure 5 Phase 4: Review and decision

Note:

If it is decided to retain the switchgear in service, an estimate of remaining life should be made and the maintenance regime modified to include regular condition monitoring.

Protection

Protection relay schemes

137 Protection relays and associated systems should be inspected and tested in addition to completing routine maintenance actions. For electronic relays, there may be no specific requirements for routine maintenance other than the inspection that will take place during a routine substation or switch room check. Testing will give an indication of the condition of the equipment and provide confirmation that the relays are functioning as intended. Comparison of test results with previous results can provide a guide to possible deterioration and assist in determining the appropriate testing/maintenance interval. Testing also provides an opportunity to verify that relay settings have not been changed. For programmable relays, software tools may be required to verify the settings within a relay. Specialist equipment may also be needed if testing by current injection is not an option.

138 Insulation resistance testing should be carried out on the secondary wiring associated with protection systems, including pilot wires if they form part of the protection circuitry. This is important since current leakage across the wiring will affect the characteristics of the protection scheme and may have a detrimental effect on operation and discrimination.

139 For an electromechanical type relay, testing will include:

- verification that the relay movement runs freely;
- checking that magnet gaps and the induction disc are clean;
- inspection of the contacts for signs of burning or pitting (refurbish as necessary);

- verification by measurement that the induction disc resetting time (electromechanical IDMT relays) is not excessive;
- verification by operation that flag mechanisms and reset knobs operate correctly;
- checking that the front cover glass and seals are satisfactory;
- checking by measurement that current transformer shorting contacts operate satisfactorily; and
- performing secondary injection tests to check the operating characteristics of the relay are within the correct limits of operation dependent on the protection type. Guidance on the test procedure can be obtained from standards, manufacturer's information or specialist testing companies.

140 Harmonics can affect the operation of electromechanical (induction) type relays. Operators of switchgear may need to take account of this in the design of protection systems, and are advised to consider power quality issues when testing or fault finding on protection systems.

141 For electronic relays, the manufacturer's instructions should be referred to for guidance. Specialist equipment may be needed to interrogate the relay to determine if any internal errors have been detected. Regardless of the relay type, secondary injection testing of the relay will enable its operation to be verified. Where secondary injection is not possible, manufacturers may provide test equipment to simulate fault operation.

Fuse protection

142 For switchgear where the protection is dependent on fuse operation, the operational tests involve carrying out fuse trip-testing (a test-trip fuse can be used, if available) to ensure that:

- single fuse operation causes all other phases to operate; and
- the manual ON/OFF trip mechanism operates correctly.

Batteries and chargers

143 Batteries for circuit-breaker tripping and closing supplies play a vital role in the overall performance of switchgear. Batteries and their associated chargers require an appropriate maintenance regime to ensure reliable performance. The failure of a tripping battery set or battery charger can result in the inability of switchgear to operate. Battery condition monitoring with alarm annunciation or remote monitoring is recommended to give early warning of any problems.

144 The battery/charger installation should be inspected, tested and maintained. The level of maintenance will depend on the type of battery and charger system in use. The battery manufacturer's operation and maintenance instructions should be followed. Recommended charging rates should be adhered to and batteries should be replaced in accordance with the life expectancy declared by the manufacturer.

145 Load testing of batteries is recommended as it is not unknown for apparently healthy batteries to fail when more than a single tripping operation is demanded by the protection system.

146 When batteries or chargers are replaced, the remaining equipment must be compatible with the new. Old batteries must be disposed of observing relevant environmental legislation.

Selection of new, replacement or refurbished switchgear

General advice

147 A number of options are available when considering the replacement or refurbishment of switchgear:

- replace the switchboard in its entirety;
- replace individual switchgear units (moving and fixed pattern);
- refurbish the switchboards or individual switchgear units; and
- retrofit new circuit breakers into existing switchgear.

148 Where the decision is made to install a complete new switchboard, the opportunity exists to consider whether direct replacement is necessary or whether the switchboard arrangement can be reconfigured and simplified. It may be opportune to include provision of spare capacity, since new equipment is likely to require less space than the equipment it replaces. New equipment is likely to incorporate improved safety features such as interlocking, and may also provide the opportunity to benefit from the additional functionality available with programmable protection systems. The provision of remote operating facilities should be considered in order to minimise the risks to personnel operating the equipment. The decision to install new equipment may also lead to a reduction in maintenance requirements.

149 Where only individual switchgear panels are to be replaced, the decision is one of like-for-like replacement, if the switchgear is still available, or the selection of an equivalent from the same manufacturer. If switchgear from a different supplier is to be used, consideration must be given to the connection of the busbar systems to ensure that the rating of both the existing and new equipment is not compromised.

150 The retention or replacement of the existing cables should also be considered. Paper insulated cables can be internally damaged by significant disturbance, and appropriate measures such as through-jointing the cables should be considered if the cables are re-used.

151 A major consideration in the decision to retain existing equipment is the level of confidence that the insulation components associated with the busbar system, transformer chambers and terminations have adequate remaining life to justify anticipated expenditure saving. An overall assessment of the switchgear should be carried out before evaluating the economics of refurbishment/retrofit against replacement. This may include condition assessment of the HV insulation using partial discharge measurement techniques.

152 The load rating and the short-circuit rating of any items of original equipment which are to be retained in a retrofit or refurbishment scheme must be carefully considered. If there is a difference between the replaced/refurbished equipment and the existing equipment, the lowest load and short-circuit rating must apply. Consequently, although new switchgear may have been installed with an increased rating, it may not be possible to use the equipment to its full rating due to the limiting effects of the remaining components. Current transformer ratings for protection relays are an example where ratings must be carefully reviewed.

153 Where the replacement of circuit-breakers within existing enclosures is intended, the following should be considered:

- the condition of the secondary wiring, protection and control equipment;
- interlocking and earthing arrangements in relation to current safety standards;

- short-circuit ratings; and
- venting arrangements (where appropriate).

Retrofit circuit-breakers for withdrawable switchgear

154 Retrofitting usually involves updating the existing moving portions of switchgear generally to incorporate vacuum or SF₆ technology. Two options can be considered:

- replacing a complete circuit-breaker truck; or
- modifying an existing truck.

155 Retrofit systems can be obtained either from switchgear manufacturers or specialist suppliers. When selecting a system, particular attention should be paid to the mechanical compatibility between the fixed portion and the new moving portion. Such problems can be minimised by close liaison between the user and supplier at all stages of a retrofit operation.

Second-hand equipment

156 Second-hand switchgear may be purchased from companies specialising in its recovery and refurbishment. If second-hand switchgear is being considered, it is important to only deal with reputable and experienced organisations. Make sure the equipment is suitable for the intended use. It may be necessary to employ an independent consultant to oversee the selection, installation and commissioning of second-hand equipment if sufficient knowledge or expertise is not available in-house.

Measures to limit fires

157 Failure of switchgear can lead to fires, and with oil-filled switchgear, this can result in a major incident. This not only poses potential fire and smoke risks to people in the vicinity and to the building fabric, but may also affect other plant, thus escalating the primary event. There are a number of techniques that can be used singularly or in combination to mitigate the effects of a fire and limit smoke spread.

Compartmentation

158 Substation plant items can be separated by fire-resisting barriers to limit the extent of any fire to the item of fire origin. There may be contradictory requirements between fire safety and explosion safety. Compartmentation needs to be carefully designed so that it can contain a fire but not inhibit any venting required for explosion control.

Control and extinction

159 Fire-extinguishing systems using extinguishing mediums such as fire-suppressant gases, water or water mist and carbon dioxide (CO₂) can be installed.

160 Portable fire-extinguishers should be provided, and procedures for checking these and any permanent systems should be carried out during the routine inspection of the switchroom or substation building.

Detection

161 The use of an appropriate automatic fire detection system can provide the electrical plant room or area with early fire detection and alarm features which

could also be linked with a control/extinction system to provide fast response fire suppression or control.

Safety issues

162 Where automatic fire protection systems are installed, there may be risks to people in the protected area when the system operates. These include:

- asphyxiation by the gases or chemical extinguishants used;
- poisoning if extinguishants are toxic;
- physical injury (falling, striking objects etc) due to poor visibility after release of the gases or chemical extinguishants; and
- effect of low temperature due to release of the gases or chemical extinguishants.

163 Entry procedures must be communicated if people are to enter an area fitted with automatic fire protection equipment. These include:

- the automatic control to be rendered inoperative before entry;
- caution notices indicating that the control is on 'non-automatic' to be fitted to the automatic/non-automatic selector;
- precautions taken to render the automatic control inoperative to be noted in any safety documents issued for work in the protected area; and
- instructions issued to staff to ensure that the system is restored to automatic control as soon as all staff have withdrawn from the area.

164 Notices requiring the above actions should be prominently displayed at the point(s) of access to the area.

Appendix 1: Examples of switchgear configurations

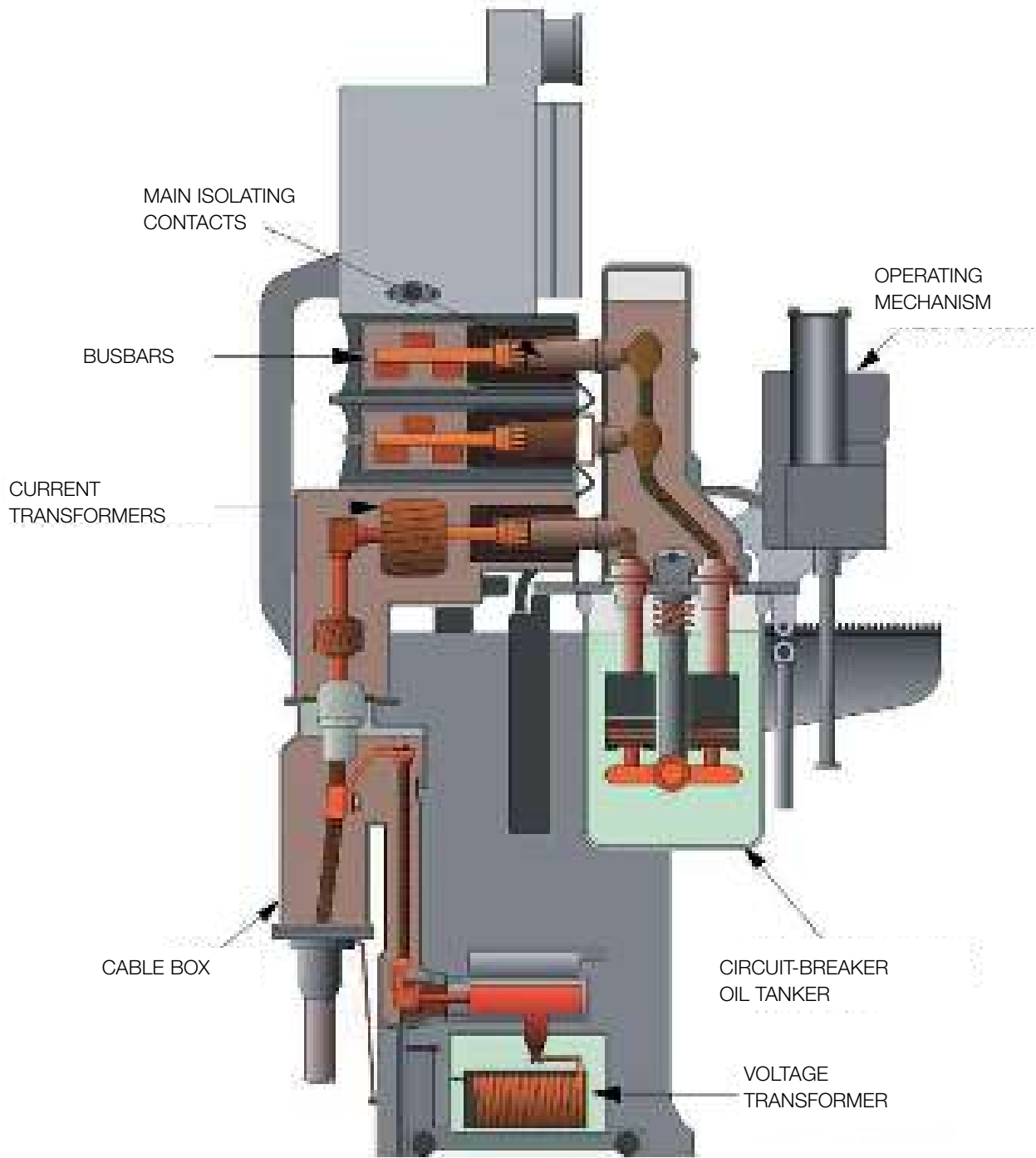

Figure 6 Typical arrangement of a horizontal isolation duplicate busbar 11 kV oil circuit-breaker

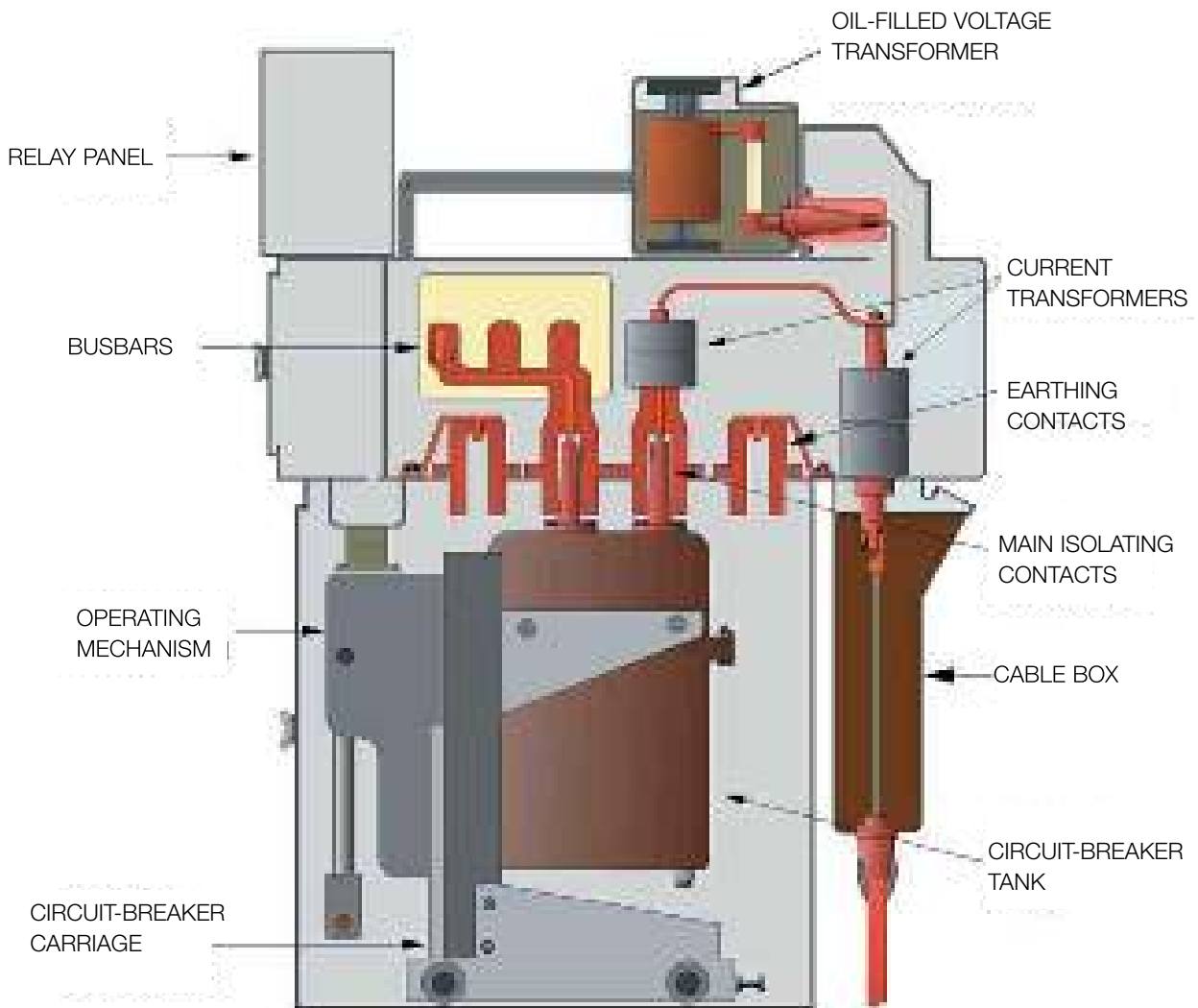

Figure 7 Typical arrangement of a vertical isolation 11 kV oil circuit-breaker panel (single busbar with feeder earthing via circuit-breaker transfer)

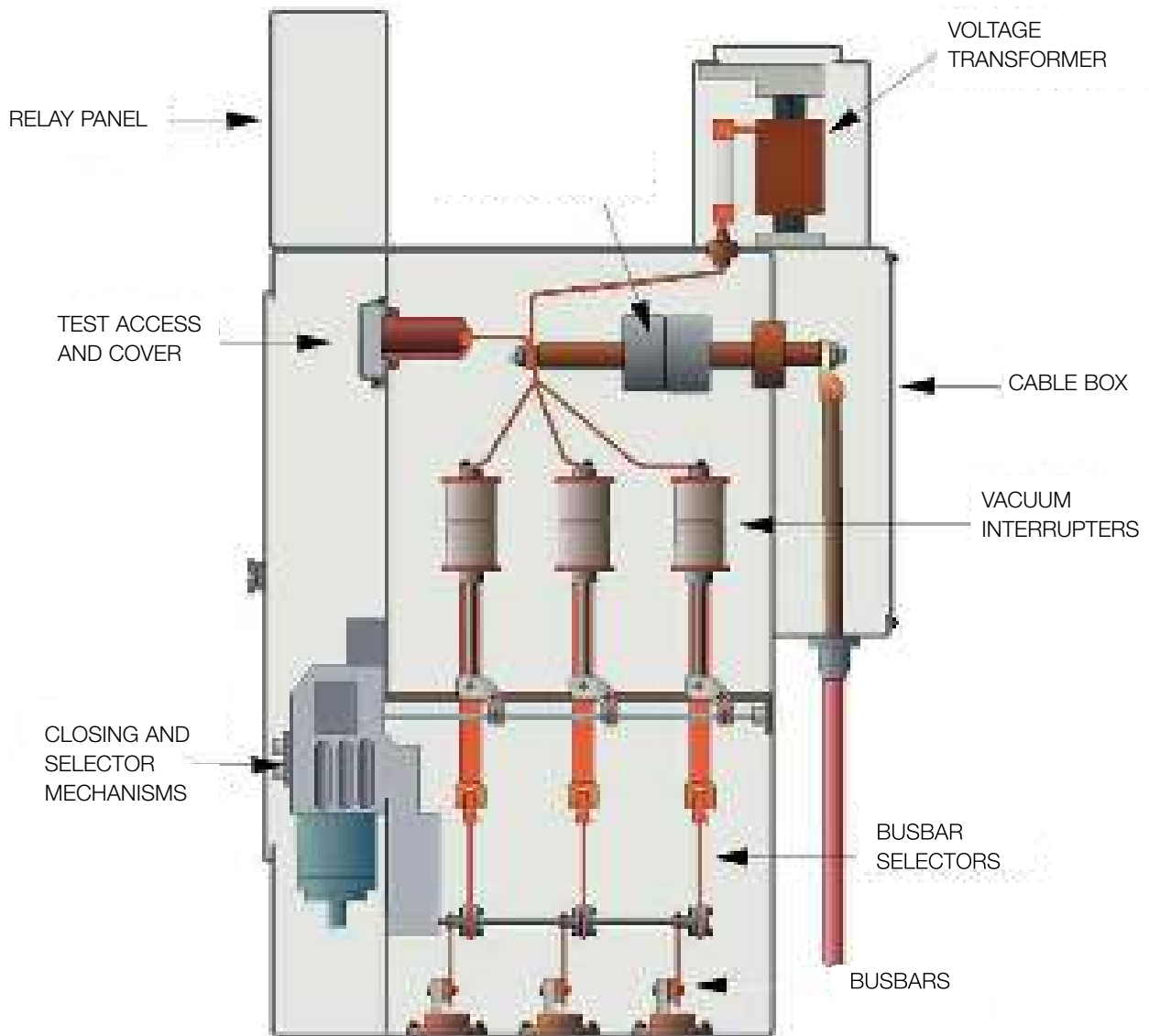

Figure 8 Typical arrangement of a single selector fixed pattern 11 kV vacuum circuit-breaker

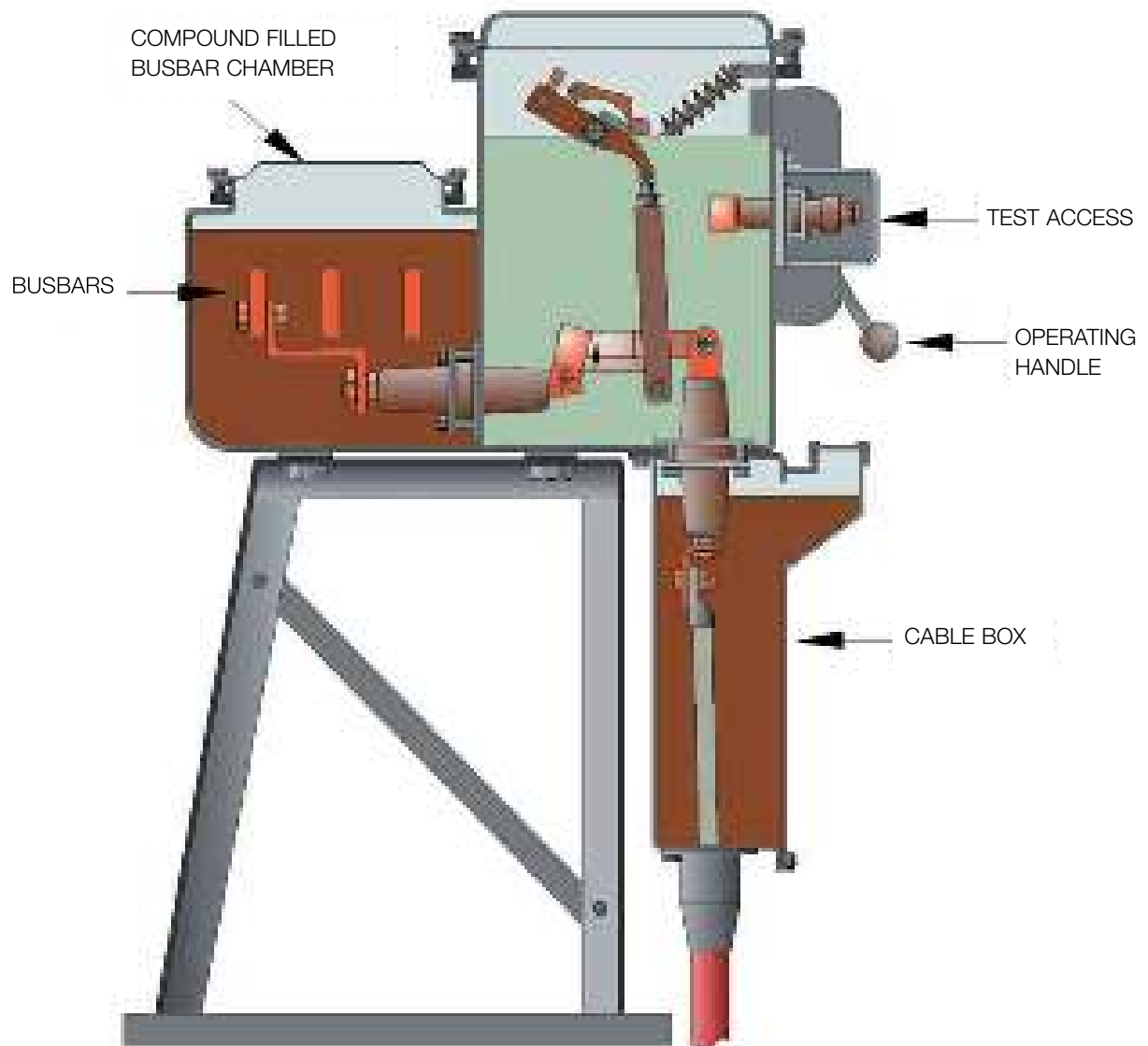

Figure 9 Typical arrangement of an 11 kV oil switch

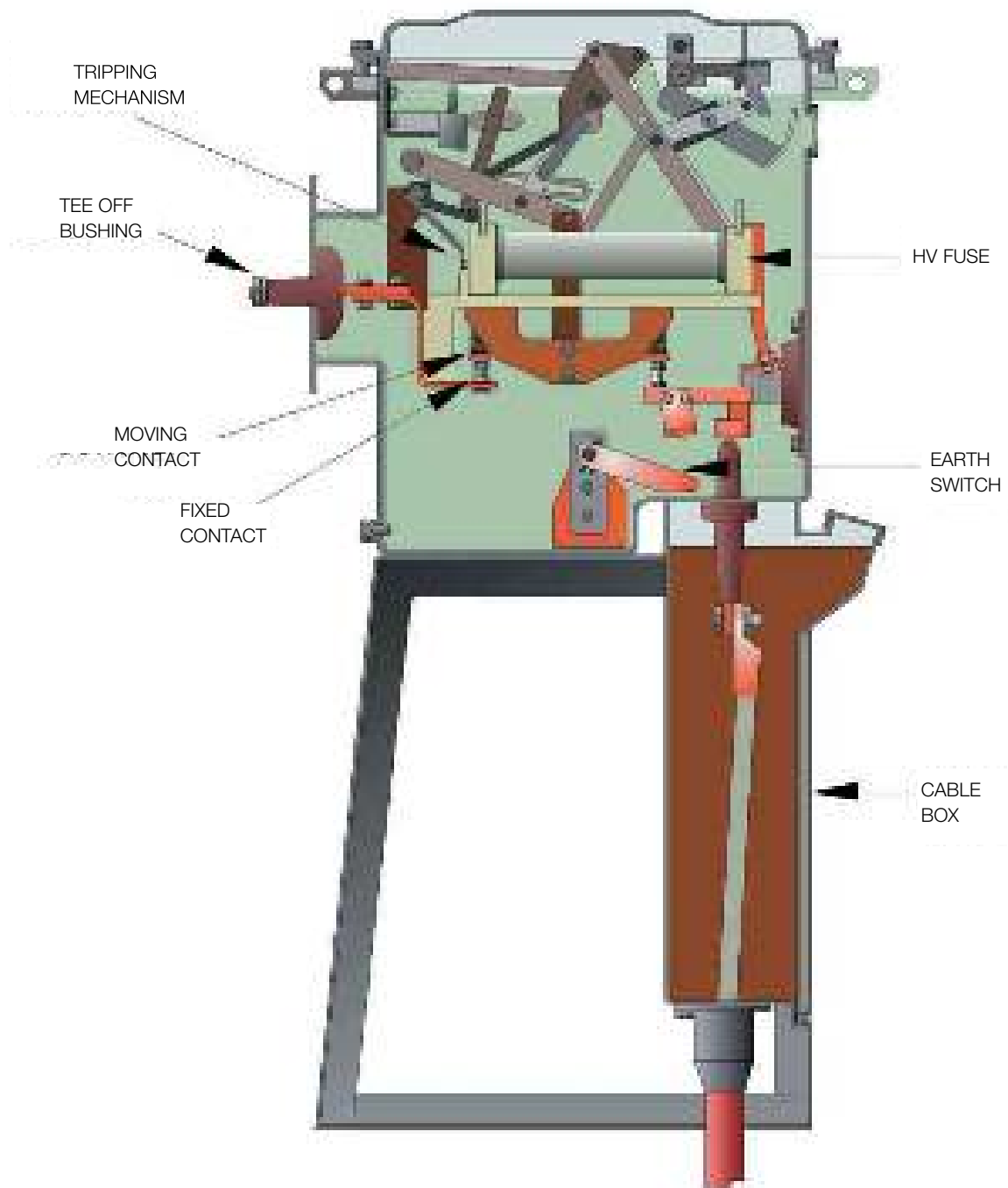

Figure 10 Typical arrangement of an 11 kV oil fuse switch

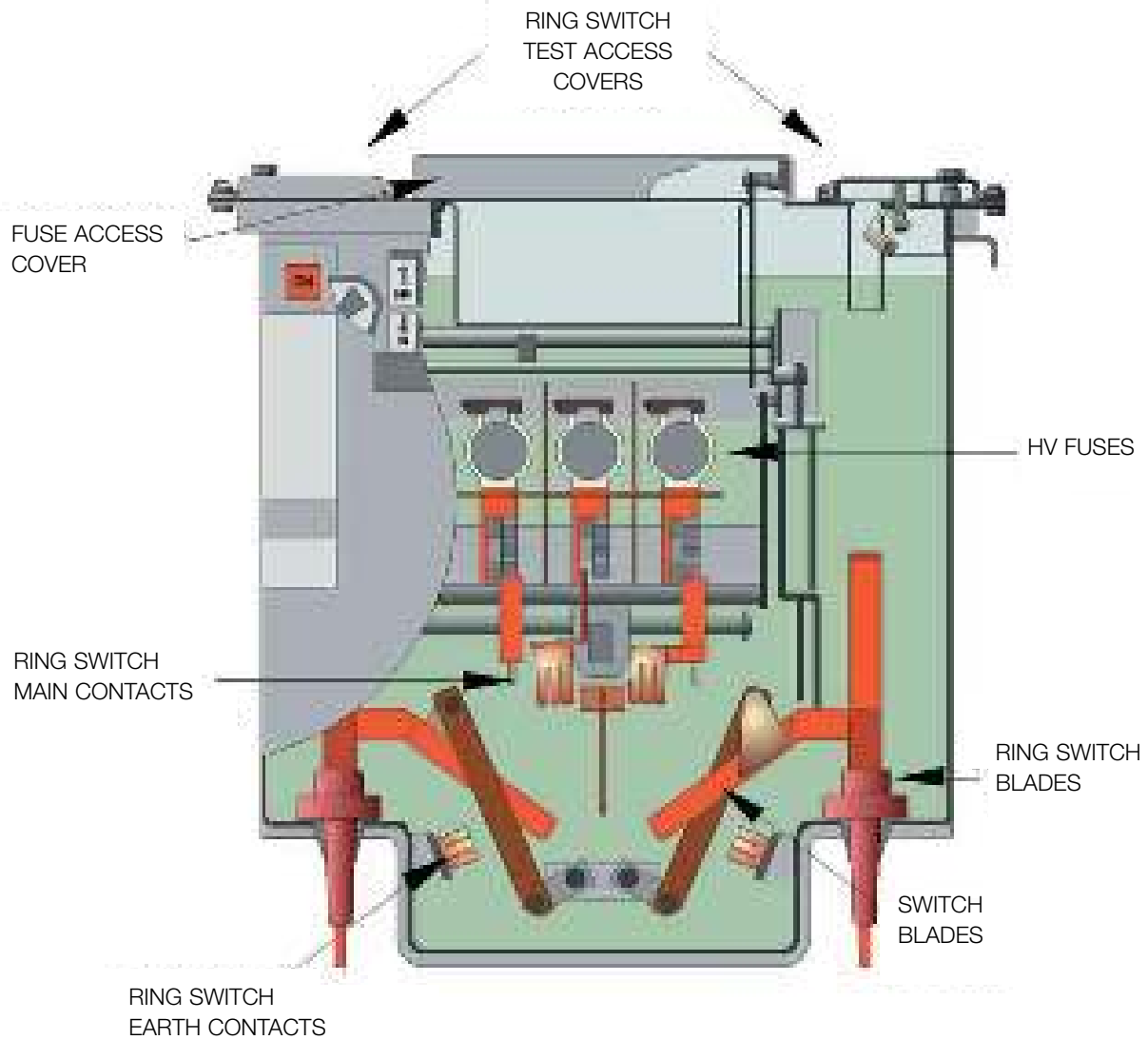

Figure 11 Typical arrangement of an 11 kV oil-filled common tank ring main unit (incorporating two ring switches and one fuse switch)

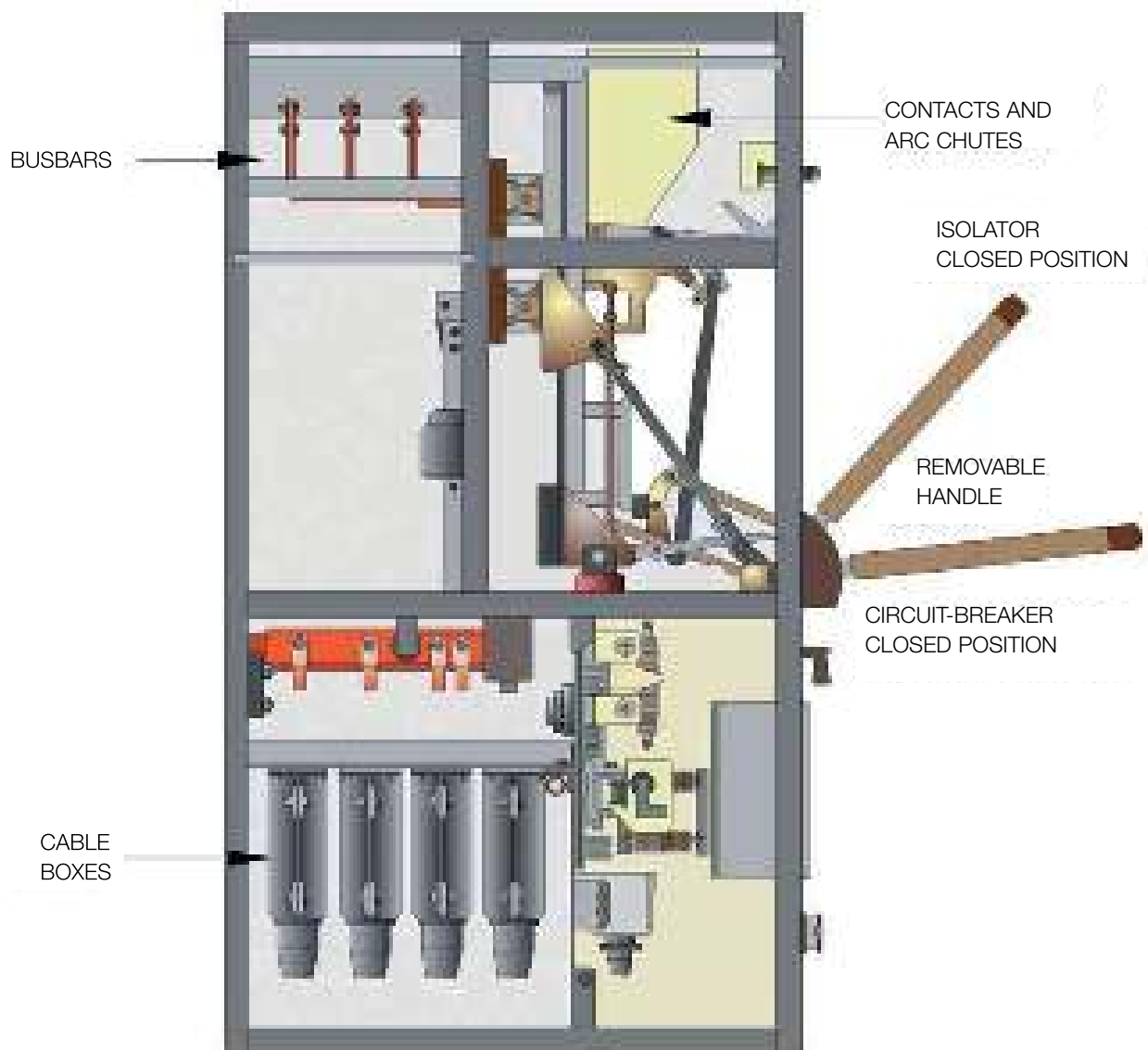

Figure 12 Typical arrangement of a 415 V air circuit-breaker

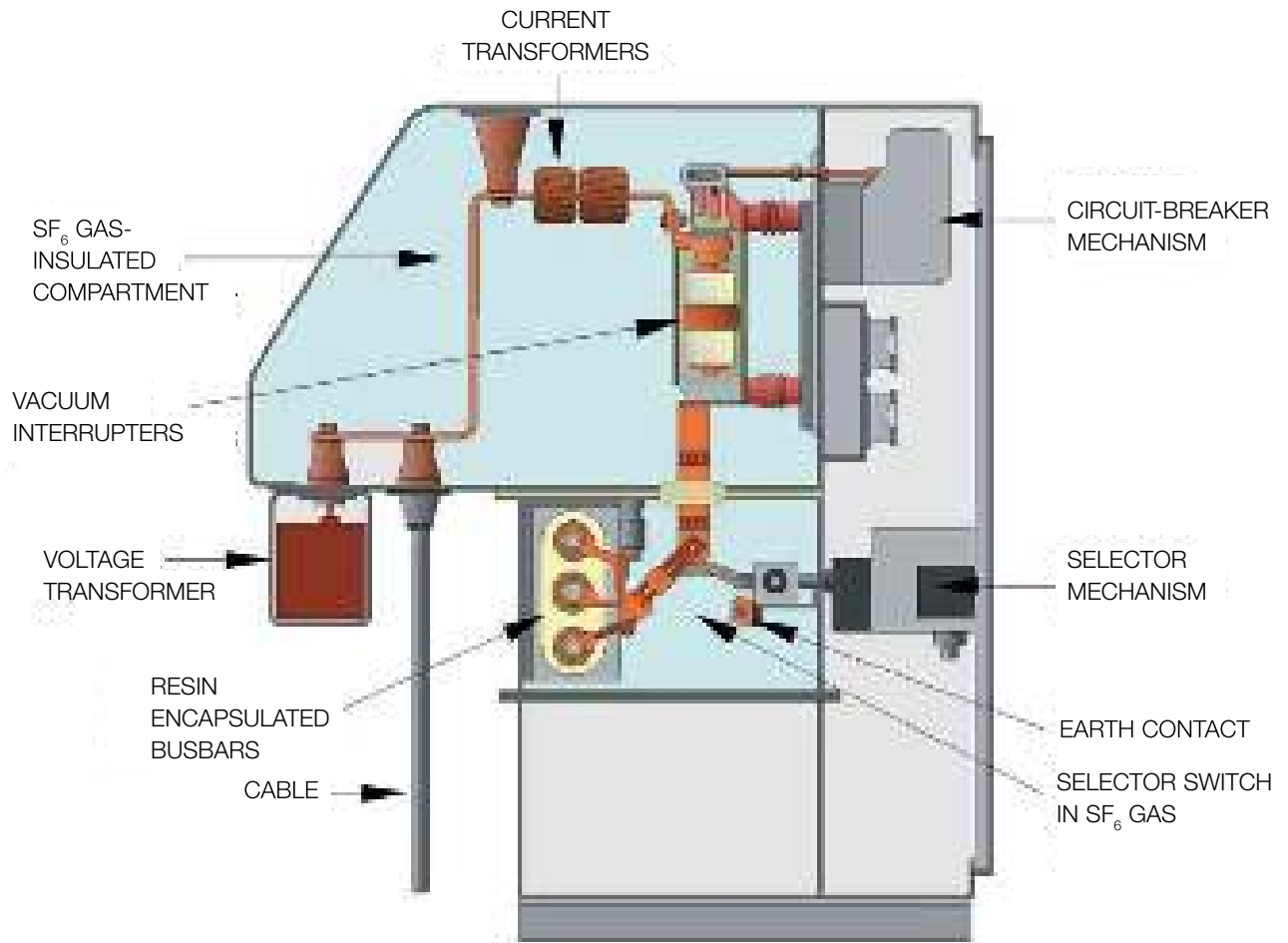

Figure 13 Typical arrangement of a 33 kV fixed-pattern vacuum circuit-breaker with sulphur hexafluoride (SF₆) gas insulation

References and further reading

References

- 1 *Electrical switchgear safety: A guide for owners and users* Leaflet INDG372(rev1) HSE Books 2013 www.hse.gov.uk/pubns/indg372.htm
- 2 *Health and Safety at Work etc Act 1974 (c37)* The Stationery Office 1974 www.legislation.gov.uk
- 3 *The Management of Health and Safety at Work Regulations 1999* SI1999/3242 The Stationery Office www.legislation.gov.uk
- 4 *The Electricity at Work Regulations 1989. Guidance on Regulations* HSR25 (Third edition) HSE Books 2015 www.hse.gov.uk/pubns/books/hsr25.htm
- 5 *Managing and working with asbestos: Control of Asbestos Regulations 2012. Approved Code of Practice and guidance* L143 (Second edition) HSE Books 2013 www.hse.gov.uk/pubns/books/l143.htm
- 6 *Risk assessment: A brief guide to controlling risks in the workplace* Leaflet INDG163(rev4) HSE Books 2014 www.hse.gov.uk/pubns/indg163.htm
- 7 *Explosives Regulations 2014: Safety provisions. Guidance on Regulations* L150 HSE Books 2014 www.hse.gov.uk/pubns/books/l150.htm
- 8 *Electricity at work: Safe working practices* HSG85 (Third edition) HSE Books 2013 www.hse.gov.uk/pubns/books/hsg85.htm
- 9 BS 6626:2010 *Maintenance of electrical switchgear and controlgear for voltages above 1 kV and up to and including 36 kV. Code of Practice* British Standards Institution
- 10 *The Electricity Safety, Quality and Continuity Regulations 2002* SI 2002/2665 The Stationery Office www.legislation.gov.uk
- 11 *Recommendations for the connection of generating plant to the distribution systems of licensed distribution network operators* G59/3 Energy Networks Association 2014 www.energynetworks.org
- 12 *Guidance and the standard specification for thermal imaging of LV electrical installations* FMS 5/99 www.bsria.co.uk
- 13 *Cadmium and you: Working with cadmium. Are you at risk?* Leaflet INDG391(rev1) HSE Books 2010 www.hse.gov.uk/pubns/indg391.htm
- 14 BS EN 60422:2013 *Mineral insulating oils in electrical equipment. Supervision and maintenance guidance* British Standards Institution
- 15 EU Directive 96/59/EC *The Disposal of Polychlorinated Biphenyls and Polychlorinated Triphenyls* <http://eur-lex.europa.eu>
- 16 *The Environmental Protection (Disposal of Polychlorinated Biphenyls and other Dangerous Substances) (England and Wales) Regulations 2000* SI 2000/1043 The Stationery Office www.legislation.gov.uk

17 *The Environmental Protection (Disposal of Polychlorinated Biphenyls and other Dangerous Substances) (Scotland) Regulations 2000* SSI 2000/95
The Stationery Office www.legislation.gov.uk

18 BS EN 62271-4:2013 *High-voltage switchgear and controlgear. Handling procedures of sulphur hexafluoride (SF₆) gas and its mixtures*
British Standards Institution

19 *Guidance on working with sulphur hexafluoride* ER G69
Energy Networks Association 2013 www.energynetworks.org

20 BS EN 60376:2005 *Specification of technical grade sulphur hexafluoride (SF₆) for use in electrical equipment* British Standards Institution

Further reading

General advice (including HSE publications)

Managing for health and safety www.hse.gov.uk/managing

Workplace exposure limits: Containing the list of workplace exposure limits for use with the Control of Substances Hazardous to Health Regulations 2002 (as amended) EH40 HSE Books www.hse.gov.uk/pubns/books/eh40.htm

British Standards relating to switchgear

BS EN 62271-103:2011 *High-voltage switchgear and controlgear. Switches for rated voltages above 1 kV up to and including 52 kV* British Standards Institution

BS EN 62271-200:2012 *High-voltage switchgear and controlgear. AC metal-enclosed switchgear and controlgear for rated voltages above 1 kV and up to and including 52 kV* British Standards Institution

BS EN 62271-106:2011 *High-voltage switchgear and controlgear. Alternating current contactors, contactor-based controllers and motor-starters*
British Standards Institution

BS EN 62271-102:2002+A2:2013 *High-voltage switchgear and controlgear. Alternating current disconnectors and earthing switches* British Standards Institution

BS EN 60947 (Series) *Low-voltage switchgear and controlgear. General requirements and circuit-breakers* British Standards Institution

British Standards relating to oil for switchgear

BS 148:2009 *Reclaimed mineral insulating oil for transformers and switchgear. Specification* British Standards Institution

Disposal of hazardous materials

Classify different types of waste

www.gov.uk/how-to-classify-different-types-of-waste

Glossary

Circuit-breaker A mechanical switching device capable of making, carrying and breaking currents under normal circuit conditions, and also making, carrying for a specified time and breaking currents under abnormal circuit conditions such as those of a short-circuit.

Contact A mechanical switching device (IEV Definition 441-14-33) having only one position of rest, operated otherwise than by hand, capable of making, carrying and breaking currents under normal circuit conditions, including operating overload conditions.

Dependent manual operation (of a mechanical switching device) (IEV Definition 441-16-13). An operation solely by means of directly applied manual energy such that the speed and force of the operation are dependent upon the action of the operator.

Dependent power operation (of a mechanical switching device) (IEV Definition 441-16-14). An operation by means of energy other than manual, where the completion of the operation is dependent upon the continuity of the power supply (to solenoids, electric or pneumatic motors etc).

Fuse switch A switch in which a fuse link or fuse carrier forms the moving contact.

High voltage Normally exceeding low voltage (see below).

Independent manual operation (of a mechanical switching device) (IEV Definition 441-16-16). A stored energy operation where the energy originates from manual power, stored and released in one continuous operation, such that the speed and force of the operation are independent of the action of the operator.

Isolator A mechanical switching device which provides in the open position an isolating distance in accordance with specified requirements. Also called a disconnect. An isolator is capable of opening and closing a circuit either when negligible current is broken or made, or when no significant change in the voltage across the terminals of each of the poles of the isolator occurs.

Low voltage Normally exceeding 50 V AC or 120 V DC, but not exceeding 1000 V AC or 1500 V DC between conductors, or 600 V AC or 900 V DC between conductors and earth.

Stored energy operation (of a mechanical switching device) (IEV Definition 441-16-15). An operation by means of energy stored in the mechanism itself prior to the completion of the operation and sufficient to complete it under predetermined conditions. This kind of operation may be subdivided according to:

- the manner of storing the energy (spring, weight etc);
- the origin of the energy (manual, electric etc); and
- the manner of releasing the energy (manual, electric etc).

Switch A mechanical switching device capable of making, carrying and breaking currents under normal circuit conditions, and also making and carrying for a specified time currents under abnormal circuit conditions such as those of a short-circuit. A switch cannot be used to break current under abnormal circuit conditions.

Switch fuse A switch in which one or more poles has a fuse connected in series in a composite unit.

Switchgear A combination of one or more switching devices together with associated control, measuring, signal, protective and regulating equipment etc completely assembled under the responsibility of the manufacturer with all the internal electrical and mechanical interconnections and structural parts.

Further information

For information about health and safety, or to report inconsistencies or inaccuracies in this guidance, visit www.hse.gov.uk/. You can view HSE guidance online and order priced publications from the website. HSE priced publications are also available from bookshops.

British Standards can be obtained in PDF or hard copy formats from BSI: <http://shop.bsigroup.com> or by contacting BSI Customer Services for hard copies only Tel: 0845 086 9001 email: cservices@bsigroup.com.

The Stationery Office publications are available from The Stationery Office, PO Box 29, Norwich NR3 1GN Tel: 0870 600 5522 Fax: 0870 600 5533 email: customer.services@tso.co.uk Website: www.tsoshop.co.uk. (They are also available from bookshops.) Statutory Instruments can be viewed free of charge at www.legislation.gov.uk where you can also search for changes to legislation.