



Southwire®



INSTALLATION INFORMATION

**POWER CABLE
INSTALLATION GUIDE**

Southwire Company
One Southwire Drive
Carrollton, Georgia 30119

© 2005 Southwire Company. All rights reserved.
Printed in the United States of America.

Hypalon is a registered trademark of E.I. DuPont DeNemours & Company.
National Electrical Code and NEC are registered trademarks of the
National Fire Protection Association.

This publication is a collection of items of general information related to the subject of power cable. It is not intended to be nor should it be used as authority for design, construction, or use of power cable. The design, construction, and use of power cable should only be undertaken by competent professionals in light of currently accepted design and engineering practices.

While great care has been employed to ensure that the tables and formulas contained herein are free of errors, absolutely no warranties, either expressed or implied, are made as to the accuracy or completeness of any such tables and formulas contained herein.

Those preparing and/or contributing to this publication specifically disclaim any warranty of any kind, either expressed or implied. The warranties of merchantability and fitness for a particular purpose are hereby specifically disclaimed by Southwire and all other parties involved in the creation, production, or delivery of this publication.

Neither Southwire nor anyone else who has been involved in the creation, production, or delivery of this publication shall be liable for any direct, indirect, consequential, or incidental damages arising out of the use, the results of the use, or inability to use such publication, even if Southwire has been advised of the possibility of such damages or claim. Some states do not allow the exclusion or limitation for consequential incidental damages, so the above limitation may not apply to you.

USING THIS GUIDE

Southwire Company's *Power Cable Installation Guide* provides installation information for extruded dielectric power cable systems. This guide covers copper and aluminum conductors from No. 14 AWG through 1000 kcmil, insulated for operation from 600 volts through 35 kilovolts. Although this guide includes specific recommendations, it is impossible to cover all possible design, installation, and operating situations for every application. Please use the information in this guide as general guidelines only. This guide is intended for users who have an understanding of the engineering fundamentals of power cable systems.

This guide includes many tables, equations, and related data for the convenience of the user. Southwire's comprehensive Product Catalog provides additional data on cable weights, dimensions, and specifications to be used in concert with this guide. This and other information can be found at www.southwire.com.

This guide is not a complete representation of the full range of wire and cable products offered by Southwire. For information on any of your wire and cable needs, please contact your local Southwire representative.

We welcome your suggestions so that we can make future editions more relevant, more current, and easier to use.

POWER CABLE INSTALLATION GUIDE

Introduction	01
GENERAL FIELD PRACTICES	01
Introduction	01
Preplanning	01
Low Ambient Temperature	02
Equipment	02
Training Radius	04
Handling and Storage Guidelines	05
Dynamometer Corrections	07
Diameters of Nonjacketed Cable Assemblies	08
Pull Boxes	08
Cable Lubrication Selection	09
INSTALLATION IN CONDUIT	10
Allowable Tension on Pulling Device	10
Maximum Tension on Cable Conductors	10
Equations for Pulling Tension	13
Coefficient of Friction	14
Configuration	15
Weight Correction Factor	15
Sidewall Pressure	16
Clearance	17
Jamming	17
Conduit Fill	18
Calculation Procedure	19
INSTALLATION IN CABLE TRAY	20
Rollers and Sheaves	20
Pulling Tensions	21

TYPICAL CALCULATION FOR CABLES IN CONDUIT	23
--	-----------

CABLES BURIED DIRECTLY IN EARTH	28
--	-----------

Depth of Burial	28
Trenching	28
Plowing	29
Supplemental Information	29

AERIAL INSTALLATION	29
----------------------------	-----------

Sag and Tension	29
Ice and Wind Loading	30
Additional Information	31

CABLES UNDER VERTICAL TENSION	31
--------------------------------------	-----------

ICEA Support Requirements	31
NEC Support Requirements	32

FIELD REMOVAL OF MOISTURE FROM POWER CABLES	33
--	-----------

Required Materials	33
General Purging Process	33
Purging Cable Conductors	34
Purging Cable Shield	35
Cable on Reels	35

FIELD TESTING	35
----------------------	-----------

Safety	35
Cable System Integrity	37
Low Potential Testing of Dielectric	37
High-Voltage Withstand Testing	39
Time-Leakage Test	41

POWER CABLE INSTALLATION GUIDE

Cables installed into conduits or trays have installation parameters such as maximum pulling tensions, sidewall pressure, clearance, and jamming, which must be considered. Other installations, such as buried and aerial, have different installation parameters. Most installations involve some general considerations, such as field handling, storage, training of ends, and junction box sizes. These and other considerations can make the difference between a good installation and one resulting in damaged cable.

Cable damaged during installation can cause service failures. Mechanical stresses during installation are generally more severe than those encountered while in service.

The following information provides guidance in recognizing these conditions and provides a methodology to aid in keeping them within acceptable limits.

GENERAL FIELD PRACTICES

Introduction

The small details can make the difference between successful installations and having to remove damaged cable. In preparing for a cable pull, it is just as important to cover the small details as it is to assure that the cable does not exceed maximum sidewall pressure; minimum bending radii and maximum pulling tensions. General field practices are provided to aid in preparing for large and small cable installations.

Preplanning

Preplanning for a pull is very important and should include the following steps:

1. Review all applicable local, state, and federal codes.
2. Consult local inspector.
3. Consult applicable information provided by national standards, cable manufacturers, and accessory and other suppliers.
4. Check cable for:
 - a. Correct size and type
 - b. Shipping damage
 - c. End seals
 - d. Special instructions
5. Check reels for:
 - a. Damage
 - b. Protruding nails that might damage cable
 - c. Staples

6. Consult equipment and cable manufacturer for approval of proper pulling equipment:
 - a. When using wood reels, use reel jack stands to support an axle through the arbor hole during payoff.
 - b. Steel reels or special reinforced wood reels are acceptable for use with electric roller payoff methods. *Caution: Electric rollers can severely damage or completely collapse non-reinforced wood reels during installation.*

Low Ambient Temperature

Low temperatures are a cause for concern when installing cables. Cable should be handled more carefully and pulled more slowly during cold weather. When cables are to be installed in cold weather, they should be kept in heated storage for at least 24 hours before installation. Cables should not be installed at ambient temperatures lower than the following:

Type of Insulation or Jacket	Minimum Temperature for Installation	
PVC	-10°C	14°F
EPR	-40°C	-40°F
PE	-40°C	-40°F
XLPE	-40°C	-40°F
SOLONON	-40°C	-40°F
PVC (Arctic)	-40°C	-40°F
CSPE (Hypalon®) or CPE	-20°C	-4°F

In climates where there are large temperature swings either intermittently or from summer to winter, jacket movement and shrinkback can occur at splices and terminations. This is probably due to a ratcheting effect associated with the expansion and contraction cycles of the environment and cable. Under certain conditions, terminations may allow entry of moisture and contaminants into the cable, thus precipitating insulation failure. Mechanical restraints, such as hose clamps and shrinkable sleeves that extend over part of the jacket and termination, that apply pressure at those points, have proven to be effective at restraining the jacket movement.¹

Equipment

Some of the equipment and arrangements used to install cable are illustrated in the following figures:

- a) At the feed-in, the curvature of the cable feed is in the same continuous arc with no reverse bends. At the pull-out, the pulling rope exits the duct directly to a pulling sheave.

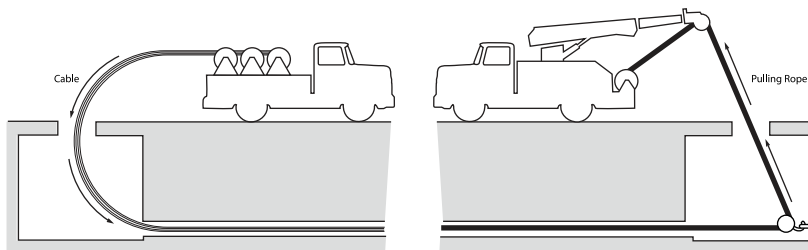

Figure F-1
Pulling Cable in Duct

¹IEEE 532-1993 "Guide for Selecting and Testing Jackets for Underground Cables."

- b) The cable is fed from the cable reel directly into the conduit at floor level. The cable is fed from the bottom of the reel so that its curvature is continuous with no reversed bends.

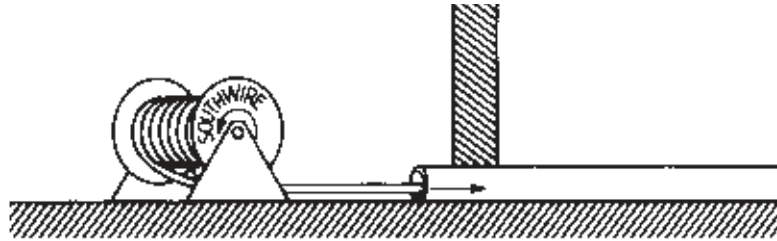

Figure F-2
Cable Feed into Conduit at Floor Level

- c) From cable reel to cable tray, the cable is fed from the top of the reel to maintain required curvature. Sheaves, or a shoe, may be used to guide the cable into the tray.

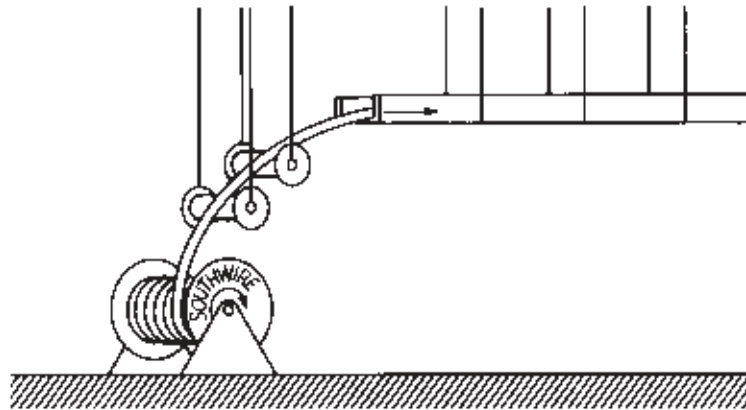

Figure F-3
Cable Feed into Cable Tray

- d) Cable sheaves or a shoe may be used to guide cable into the desired direction, maintain minimum bend radius, and reduce friction. Examples of proper and improper sheave arrangements are illustrated in the following figures.

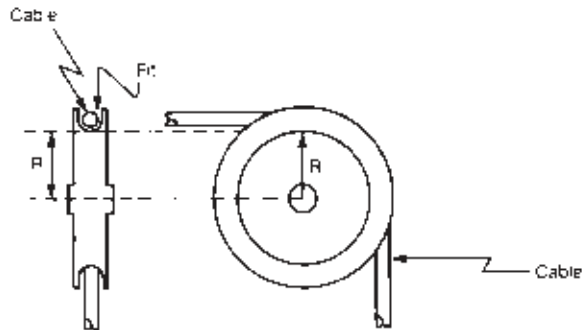

Figure F-4
Single Sheave for 90° Change of Direction
(R is radius used to calculate sidewall pressure, SP)

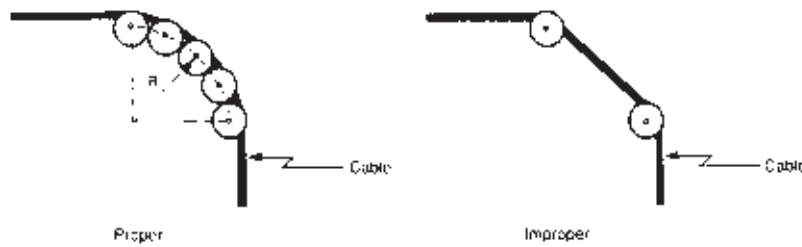

Figure F-5
Multiple Sheaves

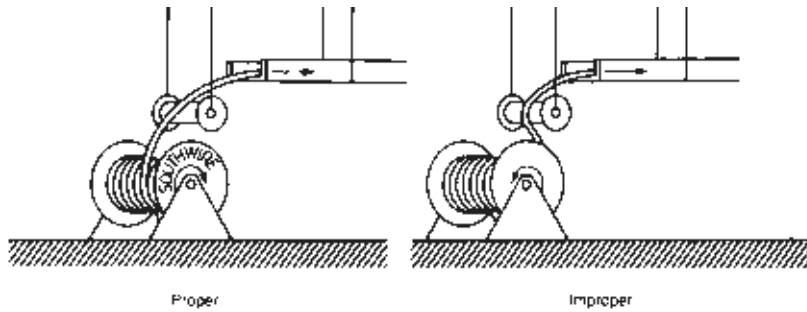

Figure F-6
Sheave Arrangements for Feeding into Cable Tray

Training Radius

The training radius is the final positioning of cable ends after the cable has been placed in the raceway. These limits should not be used for cables subjected to pulling tensions during installation.

Larger bend radii shall be considered for conduit bends, sheaves, or other curved surfaces around which the cable may be pulled under tension while being installed, due to sidewall bearing pressure limits (Table 7) of the cable.

TABLE 1

NEC RECOMMENDED MINIMUM BENDING RADII	
600 Volt Cable Constructions	Multiple of Cable O.D.
Type MC (Metal Clad) Cables (NEC 300.24)	
a) Interlocked	7
b) Smooth Sheath	
- Max diameter 0.750 inches	10
- Max diameter 1.500 inches	12
- Diameter larger than 1.500 inches	15
c) Shielded Conductors	12/7*
Type TC (Tray Cable) (NEC 336.24)	
a) Diameter 1.0 inch or less	4
b) Diameter between 1.0 inch to 2.0 inches	5
c) Diameter larger than 2.0 inches	6
d) Metallic Shielding	12

*12 times individual shielded conductor diameter or 7 times overall cable diameter, whichever is greater.

TABLE 2

NEC RECOMMENDED MINIMUM BENDING RADII	
Single and Multiple Conductors Over 600 Volts	
Shielded and Lead Covered (NEC 300.34)	12
Nonshielded and Nonarmored	8
Multiconductor or Multiplexed Cable	12/7*

*12 times individual shielded conductor diameter or 7 times overall cable diameter, whichever is greater.

A nonshielded cable can tolerate a sharper bend than a shielded cable. When bent too sharply, helical metal tapes can separate, buckle, and cut into the insulation. This problem is compounded by jackets concealing such damage. Corona problems related to metal shield damage may be initially masked by the semiconductive shielding bedding tapes or extruded polymers.

Handling and Storage Guidelines

- a. Unloading equipment should not come in contact with the cable or its protective covering.
- b. If a crane is used to unload cable, a shaft through the arbor hole or a cradle supporting both reel flanges should be used.
- c. Forklifts must lift the reel by contacting both flanges.
- d. Ramps must be wide enough to support both reel flanges.
- e. Store reels on hard surface so that the flanges will not sink and allow reel weight to rest on cable.

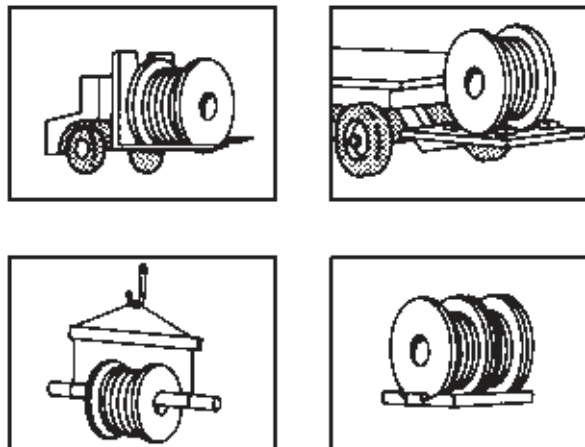

Figure F-7
Proper Reel Handling

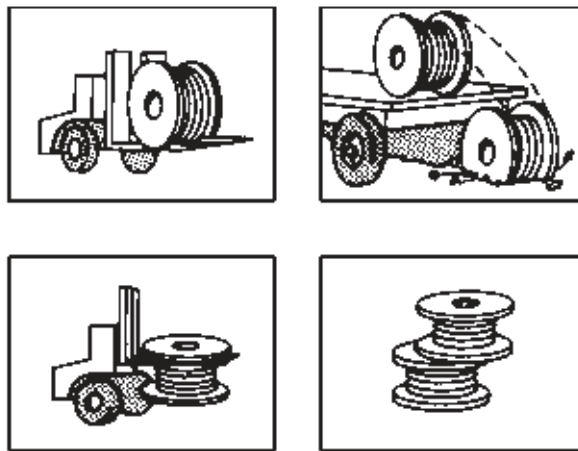

Figure F-8
Improper Reel Handling

- f. Reels should be stored out of harm's way. Consider both physical and environmental hazards.
- g. Cable ends must always be sealed to prevent the entrance of moisture, etc.
- h. Remove temporary cable lashing.
- i. While pulling, in order to eliminate sharp bend and crossovers, always have a person feed the cable(s) straight into the conduit by hand or, for larger cables, over a large diameter sheave.

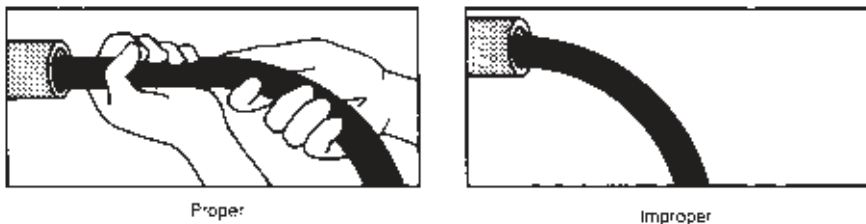
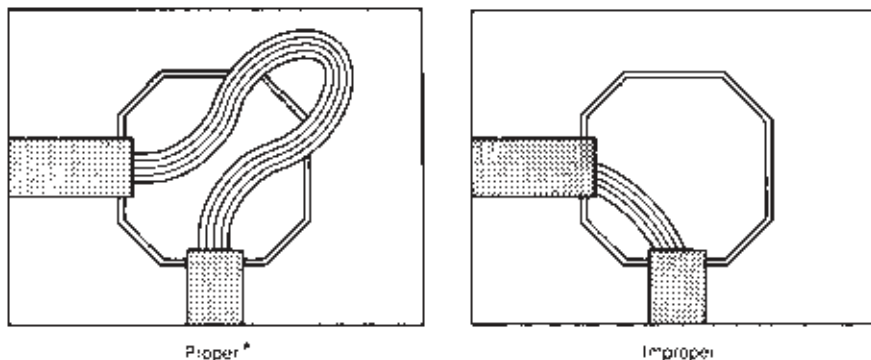

Figure F-9
Feed Into Conduit

- j. Do not pull cable directly across short, sharp angles. After pulling completely out of one side of the enclosure, feed cable into the other side of the enclosure and pull that segment.



*Caution: Minimum bending radii must be maintained.

Figure F-10
Pull-Through Enclosure

Dynamometer Corrections

The dynamometer reading (R) is dependent upon the angle of pulling line (β) from the cable to the dynamometer idler and then to the pulling mechanism; therefore, a correction to the dynamometer reading may be required to obtain the actual pulling tension (T).

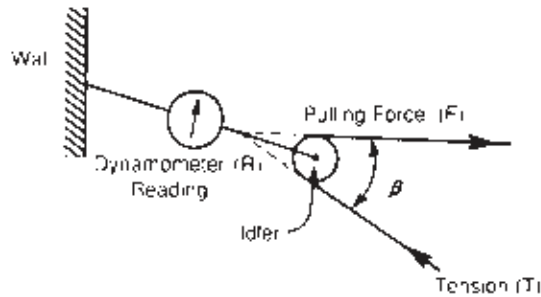

Figure F-11
Variables for Dynamometer Correction Equation

$$T = R \cdot \left[\frac{1}{2 \cos\left(\frac{\beta}{2}\right)} \right] - W \quad (E-1)$$

where: R = dynamometer reading, in pounds

β = angle between pulling line, in degrees

W = tare weight of idler pulley assembly, in pounds

Example:

What is the actual pulling tension of a cable pull where the dynamometer reading is 5000 pounds, the angle of the pulling line is 45° and the tare weight of the idler assembly is 15 pounds? Using (E-1):

$$T = 5,000 \cdot \left[\frac{1}{2 \cos\left(\frac{45}{2}\right)} \right] - 15$$

$$T = 2,690 \text{ pounds}$$

Diameters of Nonjacketed Cable Assemblies

The overall diameters of the cables in a multiple conductor assembly are used in determining the circumscribed diameter of that assembly

$$D_A = d \cdot \text{Factor} \quad (\text{E-2})$$

where: D_A = circumscribed diameter of assembly

d = diameter of one cable of assembly

Factor = for the following list

Number of Cables	Factor
1	1.000
2	2.000
3	2.155
4	2.414
5	2.700
6	3.000
7	3.000
8	3.310
9	3.610

Pull Boxes

To estimate the size of a pull box, take the greater of:

For Straight Pulls

$$L \geq 48xD_s$$

$$L \geq 32xD_N$$

For Angle or "U" Pulls

$$L_o \geq (24xD_N) + (D_1 + D_2 + \dots)$$

$$L_o \geq (24xD_N) + (D_1 + D_2 + \dots)$$

$$L_A \geq 36xD_S$$

$$L_A \geq 24xD_N$$

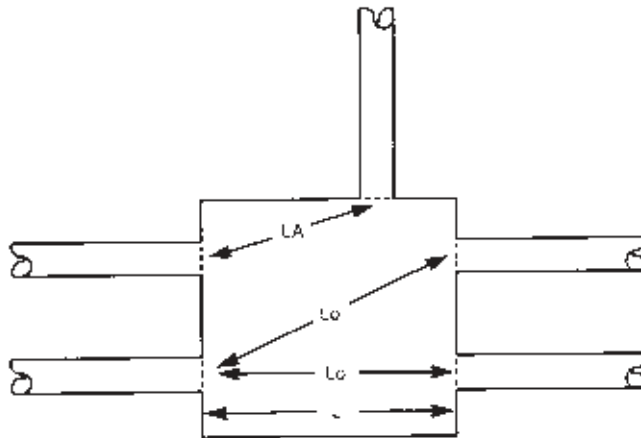

Figure F-12
Pull Box Dimensions

where: L = minimum box length, in inches

L_o = minimum distance between cable entry and exit on the opposite side of the box, in inches

L_A = minimum distance between the cable entry and the exit of the adjacent walls of the box, in inches

D_s = diameter of the largest shielded cable, in inches

D_N = diameter of the largest nonshielded cables, in inches

D_1, D_2, \dots = diameters of the remaining cable entering through the same wall of the box, in inches

For more information on sizing of pull and junction boxes, refer to the NEC Article 314. Information on spacing of conductors at pull and junction boxes is presented in Table 3.

TABLE 3

CONDUIT SPACING (INCHES)												
CENTER-TO-CENTER SPACING												
Size	1/2	3/4	1	1 1/4	1 1/2	2	2 1/2	3	3 1/2	4	5	6
1/2	1.38											
3/4	1.50	1.62										
1	1.75	1.88	2.00									
1 1/4	2.00	2.12	2.25	2.50								
1 1/2	2.12	2.25	2.38	2.62	2.75							
2	2.38	2.50	2.75	3.00	3.12	3.38						
2 1/2	2.62	2.75	3.00	3.25	3.38	3.00	4.00					
3	3.00	3.12	3.38	3.62	3.75	4.00	4.38	4.75				
3 1/2	3.38	3.50	3.62	3.88	4.00	4.38	4.62	5.00	5.38			
4	3.69	3.88	4.00	4.25	4.38	4.75	5.00	5.38	5.62	6.00		
5	4.38	4.50	4.62	4.88	5.00	5.38	5.62	6.00	6.25	6.62	7.25	
5	5.00	5.12	5.25	5.50	5.62	6.00	6.25	6.62	7.00	7.25	8.00	8.62

Cable Lubrication Selection

1. Reducing the coefficient of friction is the primary factor in the selection of a lubricant.
2. Compatibility of the lubricant with cable and conduit is extremely important. The lubricant should not have any deleterious effects on the conduit or on the physical or electrical properties of the cable insulation, semiconducting, or jacket materials.
3. The lubricant and its residue should not propagate flame.
4. The lubricant should be UL or CSA listed.
5. The lubricant should contain no waxes or greases.

Use

The cable jacket and/or conduit walls should be completely lubricated. The lubricant should be applied immediately before, and/or, during the pull. This quantity should be increased as needed for difficult pulling situations.

An estimate of the quantity of required lubricant can be determined from.²

$$Q = (0.0015) \cdot L \cdot D \quad (\text{E-3})$$

where: Q = quantity, in gallons

L = conduit length, in feet

D = outside diameter of cable or inside diameter of conduit, in inches

INSTALLATION IN CONDUIT

Calculations should be made to indicate whether the pull looks “easy” or “impossible,” making the decision to pull an obvious choice. When a “marginal” situation is encountered, the entire pull should be reviewed. This review may include more rigorous calculations or trial pulls. A final decision should be made based on installation factors known to the end user and installer.

The sizes of the conduit are determined based on the calculations of the clearances, jamming, and fill. Pulling tensions may then be evaluated by determining the maximum tension based on the pulling device used and the maximum tension that can be applied to the conductors. The lesser of these two values is the maximum allowable tension (T_m).

The pulling tension (T) required to pull the cable through the conduit is then calculated and compared to the maximum allowable tension. If the pulling tension exceeds the allowable tension, then conditions should be changed to ensure a successful pull. After calculating pulling tensions, sidewall pressures (SP) may be calculated.

For further study on this subject, AEIC Publication G5-90 and IEEE Standard 1185 present additional details.³

Allowable Tension on Pulling Device

Do not exceed the allowable tension stated by the manufacturer of the pulling eye or 10,000 pounds, whichever is less. Traditional conservative practices limit the allowable tension of a basket grip to 1,000 pounds. Under specific conditions, this limit can be safely exceeded.

Maximum Tension on Cable Conductors

The conductors of the cable are generally the only members that can bear the pulling forces without damage. Do not use metallic shielding wires, tapes, braids or armor not designed for the purpose in pulling tension calculations.

² Polywater, “Technical Talk,” volume 4.

³ AEIC Publication no G5-90, “Underground Extruded Power Cable Pulling, AEIC Task Group 28,” 2nd edition, May 2001; and IEEE Standard 1185-1994, “Guide for Installation Methods for Generating Station Cables.”

Definitions for the following equations and examples:

T_c = tension on each conductor, in pounds

S = allowable stress from Table 1, in pounds/cmil

A = area of each conductor, in cmil

N = number of conductors

T_{cable} = maximum allowable tension in the cable in pounds

T_{device} = maximum allowable tension on device in pounds

T_m = maximum allowable tension is the lesser of T_{device} or T_{cable} in pounds

TABLE 4

MAXIMUM ALLOWABLE CONDUCTOR STRESS (S)			
Cable Type	Material	Temper	lb/cmil
All	Copper	Soft	0.008
Power	Aluminum	Hard	0.008
Power	Aluminum	3/4 Hard	0.006
Power	Aluminum	AA-8000*	0.006
URD	Aluminum	1/2 Hard	0.003
Solid	Aluminum	Soft	0.002

TABLE 5

CONDUCTOR AREA			
Size	Cross-Sectional Area		
AWG or kcmil	cmil	inches²	mm²
14	4110	0.00323	2.082
12	6530	0.00513	3.308
10	10,380	0.00816	5.261
8	16,510	0.01297	8.368
7	20,820	0.01635	10.55
6	26,240	0.02061	13.30
5	33,090	0.02599	16.77
4	41,740	0.03278	21.15
3	52,620	0.04133	26.66
2	66,360	0.05212	33.63
1	83,690	0.06573	42.41
1/0	105,600	0.08291	53.49
2/0	133,100	0.1045	67.42
3/0	167,800	0.1318	85.03
4/0	211,600	0.1662	107.2
250	250,000	0.1963	126.6
300	300,000	0.2356	152.0
350	350,000	0.2749	177.4
400	400,000	0.3142	202.7
450	450,000	0.3534	228.0
500	500,000	0.3927	253.4
550	550,000	0.4320	278.7
600	600,000	0.4712	304.0
650	650,000	0.5105	329.4
700	700,000	0.5498	354.7
750	750,000	0.5890	380.0
800	800,000	0.6283	405.4
900	900,000	0.7069	456.1
1000	1,000,000	0.7854	506.7

*3/4 hard aluminum is allowed for power cable. The 2005 NEC defines use of AA-8000 for solid (8, 10, and 12 AWG) and stranded (8 AWG through 1000 kcmil) conductors.

Single Conductors

$$T_c = S \cdot A \text{ pounds} \quad (\text{E-4})$$

$$T_{\text{cable}} = T_c$$

Example:

Power Cable, single conductor, 4/0 AWG aluminum, hard

$$T_{\text{cable}} = (0.008) \cdot (211,600) \text{ pounds}$$

$$T_{\text{cable}} = 1,693 \text{ pounds}$$

Multiple Conductors

Multiple conductors in parallel, or multiplexed, and multiple conductor cables.

Three or fewer conductors

$$T_{\text{cable}} = N T_c \text{ pounds} \quad (\text{E-5})$$

Example 1: Power cable, two single conductor, 4/0 AWG aluminum, hard

$$T_{\text{cable}} = (2) \cdot (1,693) = 3,386 \text{ pounds}$$

Example 2: Power Cable, three-conductor, 4/0 AWG aluminum, hard

$$T_{\text{cable}} = (3) \cdot (1,693) = 5,079 \text{ pounds}$$

More than three conductors

$$T_{\text{cable}} = (0.8) \cdot N T_c \text{ pounds} \quad (\text{E-6})$$

Example 3: Control Cable, four conductor, 6 AWG copper

Using equation (E-4):

$$T_{\text{cable}} = S \cdot A = (0.008) \cdot (26,240) = 210 \text{ pounds}$$

Using equation (E-6)

$$T_{\text{cable}} = (0.8) \cdot N T_c \text{ pounds}$$

$$T_{\text{cable}} = (0.8) \cdot 4 \cdot (210) = 672 \text{ pounds}$$

CAUTION:

Pulling different conductor sizes at the same time is not recommended if the conductor size or other cable characteristics are significantly different.

If you must pull different size conductors, it must be done with care. For example, if a run requires three 350 kcmil and three 8 AWG single conductor cables, it would be preferable, though not necessarily ideal, to pull the three 350 kcmil single conductor cables and one three conductor 8 AWG multiple conductor cable at the same time.

Pulling additional cables into an existing conduit system is generally not recommended. If this must be done, extreme caution must be taken. Of special concern is the cutting action of the tensioned pulling rope.

Equations for Pulling Tension

The following equations are used to calculate pulling tension. They include the following variables:

- T_{in} = tension into a section in pounds
- T_{out} = tension out of a section in pounds
- w = weight correction factor, dimensionless
- μ = coefficient of dynamic friction, dimensionless
- W = total cable assembly weight on pounds/foot
- L = straight section length in feet
- Θ = straight section angle from horizontal in radians
- ϕ = bend section angle in radians
- R = bend section radius in feet
- e = 2.71 natural logarithm base

Horizontal Straight Section

$$T_{out} = w\mu WL + T_{in} \quad (E-7)$$

Inclined and Vertical Straight Section

Pulling Up a Straight Section

$$T_{out} = WL(\sin\theta + w\mu \cos\theta) + T_{in} \quad (E-8)$$

Pulling Down a Straight Section

$$T_{out} = -WL(\sin\theta - w\mu \cos\theta) + T_{in} \quad (E-9)$$

Horizontal Bend Section

$$T_{out} = T_{in} (\cosh w\mu\phi) + (\sinh w\mu\phi) \cdot \sqrt{T_{in}^2 + (WR)^2} \quad (E-10)$$

Vertical Concave Up Bend

Pulling Up Through a Bend

$$T_{out} = T_{in} e^{w\mu\phi} - \frac{WR}{1 + (w\mu)^2} \cdot [2w\mu \sin\phi - (1 - (w\mu)^2) \cdot (e^{w\mu\phi} - \cos\phi)] \quad (E-11)$$

Pulling Down Through a Bend

$$T_{out} = T_{in} e^{w\mu\phi} - \frac{WR}{1 + (w\mu)^2} \cdot [2w\mu e^{w\mu\phi} \sin\phi + (1 - (w\mu)^2) \cdot (1 - e^{w\mu\phi} \cos\phi)] \quad (E-12)$$

Vertical Concave Down Bend

Pulling Up Through a Bend

$$T_{out} = T_{in} e^{w\mu\phi} + \frac{WR}{1 + (w\mu)^2} \cdot [2w\mu e^{w\mu\phi} \sin\phi + (1 - (w\mu)^2) \cdot (1 - e^{w\mu\phi} \cos\phi)] \quad (E-13)$$

Pulling Down Through a Bend

$$T_{out} = T_{in} e^{w\mu\phi} + \frac{WR}{1 + (w\mu)^2} \cdot [2w\mu \sin\phi - (1 - (w\mu)^2) \cdot (e^{w\mu\phi} - \cos\phi)] \quad (E-14)$$

Commonly Used Approximation for Bends

It is common practice to use the following approximation in lieu of bend equations E-10, E-11, E-12, E-13, and E-14

$$T_{out} = T_{in} \cdot e^{\mu\phi} \quad (E-15)$$

Coefficient of Friction

The coefficient of dynamic friction (μ) is a measure of the friction between a moving cable and the conduit. The coefficient of friction can have a large impact on the tension calculation. It can vary from 0.1 to 1.0 with lubrication and can exceed 1.0 for unlubricated pulls. Typical values for the coefficient of friction are presented in Table 6. Pulls should never be stopped and restarted because the coefficient of static friction will always be higher than the coefficient of dynamic friction.

TABLE 6

TYPICAL COEFFICIENTS OF DYNAMIC FRICTION (μ) ADEQUATE CABLE LUBRICATION DURING PULL ^(A)				
Cable Exterior	Type of Conduit ^(B)			
	M	PVC	FIB	ASB
PVC- Polyvinyl Chloride	0.4	0.35	0.5	0.5
PE- Low Density HMW Polyethylene	0.35	0.35	0.5	0.5
PO- SOLONON™ (Polyolefin)	0.35	0.35	0.5	0.5
CSPE- Hypalon® (Chlorosulfonated Polyethylene)	0.5	0.5	0.7	0.6
XLPE- Cross-Linked PE	0.35	0.35	0.5	0.5
Nylon	0.4	0.35	0.5	0.5
CPE- Chlorinated PE	0.5	0.5	0.7	0.6

(A) These represent conservative values for use in lieu of more exact information.⁴

(B) Conduit Codes:

- M = metallic, steel or aluminum
- PVC = polyvinyl chloride, thin wall or heavy schedule 40
- FIB = fiber conduit—Orangeburg or Nocrete
- ASB = asbestos cement—Transite or Korduct

The coefficient of friction between a cable exterior (jacket/sheath) and conduit varies with the type of jacket or sheath, type and condition of conduit, type and amount of pulling lubricant used, cable temperature, and ambient temperature. High ambient temperatures (80°F and above) can increase the coefficient of dynamic friction for cable having a nonmetallic jacket.

Pulling lubricants must be compatible with cable components and be applied while the cable is being pulled. Pre-lubrication of the conduit is recommended by some lubricant manufacturers.

⁴Gene C. Neetz, "Coefficient of Friction Measurement Between Cable and Conduit Surfaces Under Varying Loads," in 1985 IEEE Transactions on Power Apparatus and Systems, vol. PAS-104, no. 1, pp. 16-21.

Configuration

The configuration of three single-conductor cables in a conduit is determined by the ratio of the conduit inner diameter (D) to the outer diameter (d) of one of the single cables (D/d ratio).

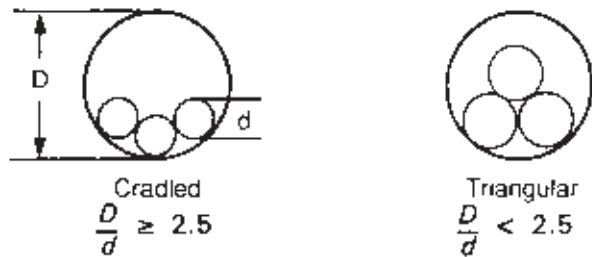

Figure F-13
Configuration of Three Single Conductors

A cradled configuration develops when three single-conductor cables are pulled into a conduit where the D/d ratio is 2.5 or greater. A triangular configuration develops when three single conductor cables are pulled into a conduit where the D/d ratio is less than 2.5. These cables may be pulled from individual reels, tandem reels, or a single reel with parallel wound cables.

Weight Correction Factor

The configuration of cables can affect cable tension. A weight correction factor (w) is used in the tension equations to account for this effect. The value for the weight correction factor is determined from the equations that follow:

1 cable (single)

$$w = 1 \quad (\text{E-16})$$

3 cables (triangular)

$$w = \frac{1}{\sqrt{1 - \left(\frac{d}{D-d}\right)^2}} \quad (\text{E-17})$$

3 cables (cradles)

$$w = 1 + \frac{4}{3} \cdot \left(\frac{d}{D-d}\right)^2 \quad (\text{E-18})$$

4 cables or more (complex)

$$w = 1.4 \quad (\text{E-19})$$

where: w = weight correction factor

D = inner diameter of conduit

d = outside diameter of the cable

Note: When pulling dual cables, use the conservative three-cable (triangular) factor.



Figure F-14
Cable Configurations

Sidewall Pressure

Sidewall Pressure (SP) is exerted on a cable as it is pulled around a bend. Excessive sidewall pressure can cause cable damage and is the most restrictive factor in many installations.

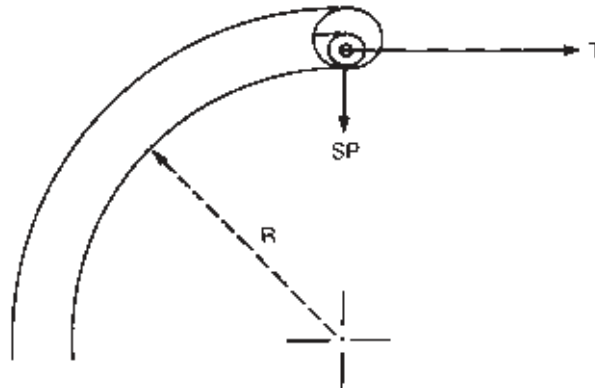

Figure F-15
Sidewall Pressure Factors

Sidewall pressure is calculated as follows:

For one single-conductor cable or multiple-conductor cable under a common jacket

$$SP = \frac{T}{R} \quad (E-20)$$

For three single-conductor cables, cradled

$$SP = (3w - 2) \cdot \frac{T}{3R} \quad (E-21)$$

For three single-conductor cables, triangular

$$SP = w \cdot \frac{T}{2R} \quad (E-22)$$

where: T = tension coming out of the bend in pounds
(See Table 5 for sweep elbows only)

R = bend radius, in feet

w = weight correction factor, dimensionless

SP = sidewall pressure in pounds/foot

Recommended maximum sidewall pressures are provided in Table 7 in the range of 300 to 500 pounds per foot, depending on type of cable. The AEIC publication "Underground Extruded Power Cable Pulling Guide" provides maximum sidewall pressures ranging from 1,000 to 2,000 pounds per foot depending on construction. Consult the cable manufacturer prior to using these higher values.

TABLE 7

RECOMMENDED MAXIMUM SIDEWALL PRESSURES

Cable Type	SP lbs/ft.
600V 1 kV nonshielded power	500
5-15 kV power	500
25-35 kV power	300
Interlocked armored cable (All Voltage Classes)	300

Clearance

Clearance is the distance between the top of the uppermost cable in the conduit and the inner top surface of the conduit. It should be at least 10% of the conduit inner diameter or one inch for large cables or installations involving numerous bends.

Equations for calculating clearance (CL) are presented as follows:

For single cable

$$CL = D - d \quad (E-23)$$

For three cables, triplexed, triangular

$$CL = \frac{D}{2} - 1.366d + \frac{D-d}{2} \cdot \sqrt{1 - \left(\frac{d}{D-d}\right)^2} \quad (E-24)$$

For three cables, cradles

$$CL = \frac{D}{2} - \frac{d}{2} + \frac{D-d}{2} \cdot \sqrt{1 - \left(\frac{d}{2(D-d)}\right)^2} \quad (E-25)$$

where: D = conduit inner diameter, in inches

d = cable outer diameter, in inches

When calculating clearance, ensure all cable diameters are equal. If in doubt, use the triplexed configuration equation. The cables may be single or multiple-conductor construction.

Jamming

Jamming is the wedging of three or more cables when pulled into a conduit. This usually occurs because of crossovers when the cables twist or are pulled around bends.

The jam ratio is the ratio of the conduit inner diameter (D) and the cable outside diameter (d).

$$\text{Jam Ratio} = \frac{D}{d} \quad (E-26)$$

The probability for jamming is presented in Figure F-16

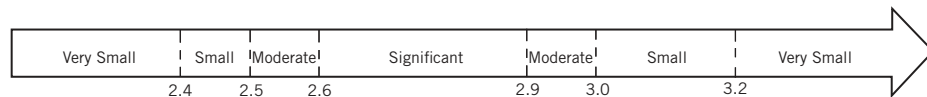

Figure F-16
Jamming Probabilities Using the Jam Ratio

In calculating jamming probabilities, a 5% factor was used to account for the oval cross-section of conduit bends.

The cable diameters should be measured, since actual diameters may vary from the published nominal values.

Conduit Fill

Conduit fill is the percentage of the area inside the conduit taken up by the cable(s). Consult applicable codes, industry standards, and manufacturers' data for further information on fill. Dimensions and percent area of conduit and tubing are provided in Table 8. Dimensions for additional types of conduits can be found in Chapter 9 of the 2005 National Electrical Code.

$$Fill = \left[\frac{d}{D} \right]^2 \cdot N \cdot 100 \text{ percent} \quad (E-27)$$

where: d = outside diameter of the cable in inches

D = inside diameter of the conduit in inches

N = number of cables

**TABLE 8
DIMENSIONS AND PERCENT AREA CONDUIT AND TUBING**

ELECTRICAL METALLIC TUBING (EMT)							
Trade Size		Internal Diameter		Total Area	2 Wires	Over 2 Wires	1 Wire
Inches	mm	Inches	mm	100% Sq. In.	31% Sq. In.	40% Sq. In.	53% Sq. In.
1/2	16	0.622	15.8	0.304	0.094	0.122	0.161
3/4	21	0.824	20.9	0.533	0.165	0.213	0.283
1	27	1.049	26.6	0.864	0.268	0.346	0.458
1 1/4	35	1.380	35.1	1.496	0.464	0.598	0.793
1 1/2	41	1.610	40.9	2.036	0.631	0.814	1.079
2	53	2.067	52.5	3.356	1.040	1.342	1.778
2 1/2	63	2.731	69.4	5.858	1.816	2.343	3.105
3	78	3.356	85.24	8.846	2.742	3.538	4.688
3 1/2	91	3.834	97.38	11.545	3.579	4.618	6.119
4	103	4.334	110.1	14.753	4.573	5.901	7.819

RIGID PVC CONDUIT SCHEDULE 40 AND HDPE CONDUIT						
Trade Size	Internal Diameter		Total Area	2 Wires	Over 2 Wires	1 Wire
Inches	Inches	mm	100% Sq. In.	31% Sq. In.	40% Sq. In.	53% Sq. In.
1/2	0.602	15.3	0.285	0.088	0.114	0.151
3/4	0.804	20.4	0.508	0.157	0.203	0.269
1	1.029	26.1	0.832	0.258	0.333	0.441
1 1/4	1.360	34.5	1.453	0.450	0.581	0.770
1 1/2	1.590	40.4	1.986	0.616	0.794	1.052
2	2.047	51.99	3.291	1.020	1.316	1.744
2 1/2	2.445	62.10	4.695	1.455	1.878	2.488
3	3.042	77.27	7.268	2.253	2.907	3.852
3 1/2	3.521	89.43	9.737	3.018	3.895	5.161
4	3.998	101.5	12.554	3.892	5.022	6.654
5	5.016	127.4	19.761	6.126	7.904	10.473
6	6.031	153.2	28.567	8.856	11.427	15.141

TABLE 8 (CONTINUED)

RIGID PVC CONDUIT, SCHEDULE 80						
Trade Size	Internal Diameter		Total Area	2 Wires	Over 2 Wires	1 Wire
Inches	Inches	mm	100% Sq. In.	31% Sq. In.	40% Sq. In.	53% Sq. In.
1/2	0.526	13.4	0.217	0.067	0.087	0.115
3/4	0.722	18.3	0.409	0.127	0.164	0.217
1	0.936	23.8	0.688	0.213	0.275	0.365
1 1/4	1.255	31.88	1.237	0.383	0.495	0.656
1 1/2	1.476	37.49	1.711	0.530	0.684	0.907
2	1.913	48.59	2.874	0.891	1.150	1.152
2 1/2	2.290	58.71	4.119	1.277	1.647	2.183
3	2.864	72.75	6.442	1.997	2.577	3.414
3 1/2	3.326	84.48	8.688	2.693	3.475	4.605
4	3.786	96.16	11.258	3.490	4.503	5.967
5	4.768	121.1	17.855	5.535	7.142	9.463
6	5.709	145.0	25.598	7.935	10.239	13.567

FLEXIBLE METAL CONDUIT						
Trade Size	Internal Diameter		Total Area	2 Wires	Over 2 Wires	1 Wire
Inches	Inches	mm	100% Sq. In.	31% Sq. In.	40% Sq. In.	53% Sq. In.
3/8	0.384	9.75	0.116	0.036	0.046	0.061
1/2	0.635	16.1	0.317	0.098	0.127	0.168
3/4	0.824	20.9	0.533	0.165	0.213	0.282
1	1.020	25.91	0.817	0.256	0.327	0.433
1 1/4	1.275	32.39	1.277	0.396	0.511	0.677
1 1/2	1.538	39.07	1.857	0.576	0.743	0.984
2	2.040	51.82	3.269	10.13	1.307	1.732
2 1/2	2.500	63.50	4.909	1.522	1.964	2.602
3	3.000	76.20	7.069	2.191	2.827	3.746
3 1/2	3.500	88.90	9.621	2.983	3.848	5.099
4	4.000	101.6	12.566	3.896	5.027	6.660

Calculation Procedure

The following is a recommended procedure for calculating installation parameters for cables in conduit:

- a. Select conduit size based on required fill, clearance, jamming, and applicable codes and standards.
- b. Select values for conduit type, bend radii, and coefficient of friction. Table 9 lists the inside radius for manufactured rigid steel conduit sweep elbows.
- c. Determine cable weight (W) from manufacturers' data sheets.
- d. Calculate weight correction factor (w).
- e. Calculate maximum allowable tension.
- f. Calculate pulling tension (T) and sidewall pressure (SP) for each segment.
- g. Compare calculated results to established limits.
- h. If limits are exceeded, consider one or more of the following:
 - 1) Increase bend radii
 - 2) Decrease fill
 - 3) Reduce number of bends
 - 4) Reverse pull
 - 5) Pull in stages
 - 6) Decrease length of pull

TABLE 9

SWEEP ELBOW RADIUS								
Elbow Centerline Radius (inches)								
	12	15	18	24	30	36	42	48
Conduit Size	Elbow Centerline Radius (feet)							
1	0.96	1.21	1.46	1.96	2.46	2.96	3.46	3.96
1 1/4	0.94	1.19	1.44	1.94	2.44	2.94	3.44	3.94
1 1/2	0.93	1.18	1.43	1.93	2.43	2.93	3.43	3.93
2	0.91	1.16	1.41	1.91	2.41	2.91	3.41	3.91
2 1/2		1.15	1.40	1.90	2.40	2.90	3.40	3.90
3			1.37	1.87	2.37	2.87	3.37	3.87
3 1/2			1.35	1.85	2.35	2.85	3.35	3.85
4				1.83	2.33	2.83	3.33	3.83
5					2.29	2.79	3.29	3.79
6						2.75	3.25	3.75

INSTALLATION IN CABLE TRAY

When pulling cable into cable trays the same approach should be used for cable installed into conduit. Care must be given to the run lengths, number of cable turns, and cable sheave size to ensure the cable's maximum pulling tension, minimum bending radius, and maximum allowable sidewall pressure are not exceeded, subjecting the cable to possible damage.

Rollers and Sheaves

When pulling around bends in cable tray, excessive sidewall pressure can damage the cable. Sidewall pressure can be reduced by using a large radius sheave. Many times, a large radius sheave cannot be used and an assembly of multiple smaller sheaves is used. Care should be given to prevent damage due to high sidewall pressure on the individual sheaves. The individual sheaves should have a minimum inside radius of 1.25 inches with at least one sheave per 20° of the bend. A three-sheave assembly for a 90° bend should never be used.

Rollers and sheaves must be well-maintained and lubricated to achieve the lowest possible coefficient of friction.

Roller Mounting

- Rollers must be properly spaced to prevent the cable from touching the tray.
- Rollers must be free-turning.
- When the tray changes direction, vertically or horizontally, sheave radii must be large enough to meet the minimum bending and maximum allowable sidewall pressure limits.

Roller Spacing

Roller spacing will vary with:

- Cable weight
- Cable tension
- Cable construction
- Roller height above the tray

To estimate roller spacing, the following equation can be used:

$$s = \sqrt{\frac{8hT}{w}} \text{ feet} \quad (\text{E-28})$$

where: s = distance between rollers, in feet

h = height of top roller above the tray bottom, in feet

T = tension, in pounds

w = weight of cable, per foot

The distance will be conservative for armored cable because the equation assumes a perfectly flexible cable. When possible, a length of cable should be used to determine maximum spacing under no tension, as a check for the calculated values.

Pulling Tensions

Calculations of pulling tensions for cable trays are similar to those for pulling cable in conduit, adjusting the coefficient of friction to reflect using rollers and sheaves.

Horizontal Straight Sections

The tension for a horizontal straight section of cable tray can be estimated with the following equation:

$$T_{out} = \mu WL + T_{in} \text{ pounds} \quad (\text{E-29})$$

where: T_{out} = tension out of a section, in pounds

μ = coefficient of dynamic friction ($\mu = 0.15$)

W = total cable assembly weight, in pounds/foot

L = straight section length, in feet

T_{in} = tension into a section, in pounds

The coefficient of friction (μ) equal to 0.15 accounts for the low-rolling friction of well-maintained rollers.

Inclined Straight Sections

Use the following equation for pulling **up** an inclined straight section:

$$T_{out} = WL(\sin\theta + \mu \cos\theta) + T_{in} \text{ pounds} \quad (\text{E-30})$$

Use the following equation for pulling **down** an inclined straight section:

$$T_{out} = -WL(\sin\theta - \mu \cos\theta) + T_{in} \text{ pounds} \quad (\text{E-31})$$

where: T_{out} = tension out of a section, in pounds

W = total cable assembly weight, in pounds/foot

θ = straight section angle from horizontal, in radians

L = straight section length, in feet

μ = coefficient of dynamic friction ($\mu = 0.15$)

T_{in} = tension into a section, in pounds

Vertical Sections

When pulling straight up or down, the equation for inclined pulls simplifies to the following equations:

Pulling Straight Up

$$T_{out} = WL + T_{in} \text{ pounds} \quad (\text{E-32})$$

Pulling Straight Down

$$T_{out} = -WL + T_{in} \text{ pounds} \quad (\text{E-33})$$

where: W = total cable assembly weight, in pounds/foot

L = straight vertical section length, in feet

Tension in Bends

If the sheaves in the bends in cable trays are well-maintained, they will not have the multiplying effect on tension that bends in conduit have. The sheaves will turn with the cable, allowing the coefficient of friction to be assumed zero. This results in the commonly-used approximation for conduit bend equation ($e^{\mu\theta}$), becoming one. Even though cable tray bends produce no multiplying effect, it is essential for heavier cables to include the force required to bend the cable around the sheave. A 200-pound adder per bend should be used for a three-conductor 500 kcmil copper conductor armored cable. If the sheaves are not well-maintained, the bend will have a multiplying effect. The tension in the pull must then be calculated using the same equations used for installations in conduit.

Tension Entering Cable Tray

Because the tension entering the cable tray is rarely zero, it is critical that the tension required to remove the cable from the reel be used to calculate the total tension for the installation.

Many times it is difficult to know the location of the reel of cable until the cable is being installed. The following equations are used to approximate the tension entering the cable tray and can be used to determine how critical the reel position will be for the cable pull.

Feeding Off Reel Horizontally

When the cable reel can be elevated so that the cable can be pulled directly into the tray, the following equation should be used to approximate the tension required to remove the cable from the reel:

$$T_{reel} = 25W \text{ pound} \quad (\text{E-34})$$

where: T_{reel} = tension, in pounds

W = total cable assembly weight, in pounds/foot

Feeding Off Reel Vertically

When the cable reel must be positioned directly below the cable tray the following equation should be used to approximate the tension required to pull the cable into the tray.

$$T = WL \text{ pounds} \quad (\text{E-35})$$

where: W = total cable assembly weight, in pounds/foot

L = straight vertical section length, in feet

The tension can now be approximated for pulling the cable into the tray from a horizontal position when the reel is placed directly under the tray. To estimate the tension entering the cable tray when the reel must be placed away from and below the entrance to the tray, use the equation for feeding off the reel vertically where the height (L) is the vertical distance between the reel and cable tray. To allow for bending forces as the cable comes off the reel, the minimum tension added should be $25W$.

TYPICAL CALCULATION FOR CABLES IN CONDUIT

Example:

Three THHN single-conductor 4/0 AWG copper

Single-conductor diameter (d) = 0.626 inches

Cable weight (W) = 3x 0.711 lbs/ft = 2.13 lbs/ft

Pulling device (T_{device}) = 10,000 pound eye

EMT conduit, trade size 2 inch

Bends 1-2, 3-4, and 5-6 are 90° (1.57 radians)

Use 36-inch sweep elbows (inside radius 2.91 feet)

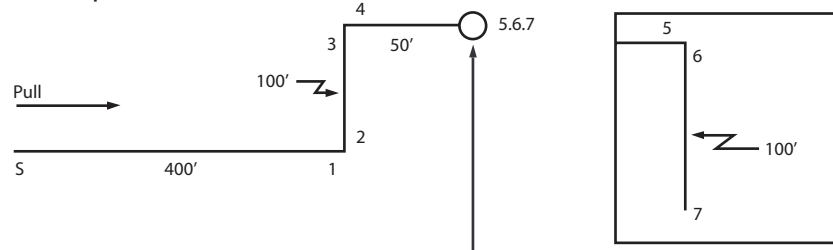

Figure F-17
Conduit Layout

1. Select conduit size based on required fill, clearance, jamming, and applicable codes and standards.
 - a) EMT trade size 2 inch: $D = 2.067$ inches from Table 8
 - b) Conduit fill, using equation (E-27):

$$Fill = \left[\frac{d}{D} \right]^2 \cdot N \cdot 100 \text{ percent}$$

$$Fill = \left[\frac{0.626}{2.067} \right]^2 \cdot 3 \cdot 100 \text{ percent}$$

$$Fill = 27.5\%$$

Within limits, if we assume 40% fill as the maximum specification requirements.

- c) Configuration, jamming, clearance

First determine **configuration** (See Figure F-13)

$$\frac{D}{d} = \frac{2.067}{0.626} = 3.3$$

Because:

$$\frac{D}{d} = \text{is greater than } 2.5$$

Configuration will be cradled.

Jamming can now be evaluated using equation (E-26)

$$\frac{D}{d} = 3.3$$

Jamming is acceptable because the probability for jamming is very small since:

$$\frac{D}{d} \text{ is greater than } 3.2$$

Clearance can be determined using equation (E-25)

$$CL = \frac{D}{2} - \frac{d}{2} + \frac{D-d}{2} \cdot \sqrt{1 - \left[\frac{d}{2(D-d)} \right]^2}$$

$$CL = \frac{2.067}{2} - \frac{0.626}{2} + \frac{2.067 - 0.626}{2} \cdot \sqrt{1 - \left[\frac{0.626}{2(2.067 - 0.626)} \right]^2}$$

$$CL = 1.424 \text{ inches}$$

Clearance is acceptable because clearance is significantly greater than 10% of the conduit inside diameter, and is also greater than 1 inch.

2. Select values for conduit type, bend radii, and coefficient of friction
 EMT conduit, trade size 2 inch from Table 8
 All bends are 90° (= 1.57 radians)
 36-inch sweep elbow from Table 9
 Bend radii = 2.91 feet
 Coefficient of friction (μ) = 0.4 from Table 6

3. Calculate weight correction factor (w) using equation (E-18), three cables, cradled.

$$w = 1 + \frac{4}{3} \cdot \left(\frac{d}{D-d} \right)^2$$

$$w = 1 + \frac{4}{3} \cdot \left(\frac{0.626}{2.067 - 0.626} \right)^2$$

$$w = 1.25$$

4. Calculate maximum allowable tension (T_m) using equations (E-4) and (E-5):

$$T_c = S \cdot A = (0.008) \cdot (211,600) = 1,693 \text{ pounds}$$

$$T_{cable} = N \cdot T_c = (3) \cdot (1,693) = 5,079 \text{ pounds}$$

$$T_{device} = 10,000 \text{ pounds}$$

Because T_{cable} is less than T_{device}

$$T_m = T_{cable} = 5,079 \text{ pounds}$$

5. Calculate pulling tension for each segment of the cable run.

- a) Tension at point S , assuming no reel drag.

$$T_s = T_{in} \approx 0 \text{ pounds}$$

- b) Segment S to 1

For horizontal straight section using equation (E-7), calculate tension T_{out} at point 1.

$$T_{out} = w\mu WL + T_{in}$$

$$T_{out} = (1.25) \cdot (0.4) \cdot (2.13) \cdot (400) + 0$$

$$T_{out} = 426 \text{ pounds}$$

Within limits, below 5,079 lbs. (T_m)

c) Segment 1 to 2

For horizontal bend section using approximate equation (E-18), calculate tension T_{out} at point 2.

$$T_{out} = T_{in} \cdot e^{w\mu\phi}$$

$$T_{out} = (426) \cdot e^{[(1.25) \cdot (0.4) \cdot (1.57)]}$$

$$T_{out} = 934 \text{ pounds}$$

Within limits, below 5,079 lbs. (T_m)

d) Segment 2 to 3

For horizontal straight section using equation (E-7), calculate tension T_{out} at point 3.

$$T_{out} = w\mu WL + T_{in}$$

$$T_{out} = (1.25) \cdot (0.4) \cdot (2.13) \cdot (100) + 934$$

$$T_{out} = 1,041 \text{ pounds}$$

Within limits, below 5,079 lbs. (T_m)

e) Segment 3 to 4

For horizontal bend section using approximate equation (E-15), calculate tension T_{out} at point 4.

$$T_{out} = T_{in} \cdot e^{w\mu\phi}$$

$$T_{out} = (1,041) \cdot e^{[(1.25) \cdot (0.4) \cdot (1.57)]}$$

$$T_{out} = 2,282 \text{ pounds}$$

Within limits, below 5,079 lbs. (T_m)

f) Segment 4 to 5

For horizontal straight section using equation (E-7), calculate tension T_{out} at point 5.

$$T_{out} = w\mu WL + T_{in}$$

$$T_{out} = (1.25) \cdot (0.4) \cdot (2.13) \cdot (50) + 2,282$$

$$T_{out} = 2,335 \text{ pounds}$$

Within limits, below 5,079 lbs. (T_m)

g) Segment 5 to 6

Vertical concave downbend using approximate equation (E-15), calculate tension T_{out} at point 6.

$$T_{out} = T_{in} \cdot e^{w\mu\phi}$$

$$T_{out} = (2,335) \cdot e^{[(1.25) \cdot (0.4) \cdot (1.57)]}$$

$$T_{out} = 5,119 \text{ pounds}$$

CAUTION:

Probably acceptable even through slightly above 5,079 lbs. (T_m)

h) Segment 6 to 7

Pulling down vertical straight section using equation (E-9), calculate tension T_{out} at point 7.

$$T_{out} = -WL(\sin\theta - w\mu \cos\theta) + T_{in}$$
$$T_{out} = -(2.13) \cdot (100) \cdot [(1) - (1.25) \cdot (0.4) \cdot (0)] + 5,119$$
$$T_{out} = 4,906 \text{ pounds}$$

Within limits, below 5,078 lbs. (T_m)—caution is advised.

6. Calculate sidewall pressures (SP) at each bend of the pull for cradled configuration (E-18) and a maximum value of 500 pounds per foot from Table 7.

a) Segment 1 to 2

$$SP = (3w - 2) \cdot \frac{T}{3R}$$
$$SP = [(3 \cdot 1.25) - 2] \cdot \left[\frac{934}{3 \cdot 2.91} \right]$$
$$SP = 187 \text{ pounds/ft}$$

Within limits, less than 500 pounds per foot.

b) Segment 3 to 4

$$SP = [(3 \cdot 1.25) - 2] \cdot \left[\frac{2,282}{3 \cdot 2.91} \right]$$
$$SP = 457 \text{ pounds/ft}$$

Within limits.

c) Segment 5 to 6

$$SP = [(3 \cdot 1.25) - 2] \cdot \left[\frac{5,119}{3 \cdot 2.91} \right]$$
$$SP = 1,026 \text{ pounds/ft}$$

Exceeds limits. Not Acceptable: For possible solutions, refer to page 19, Calculation Procedure section.

CABLES BURIED DIRECTLY IN EARTH

The NEC, NESC, and IEEE provide basic information regarding direct burial of electrical cables.⁵

Depth of Burial

1. The depth of burial shall be sufficient to protect the cable from damage imposed by expected surface usage.
2. Burial depths as indicated in Table 6 are considered adequate for supply cables or conductors, except as noted in a, b, or c.

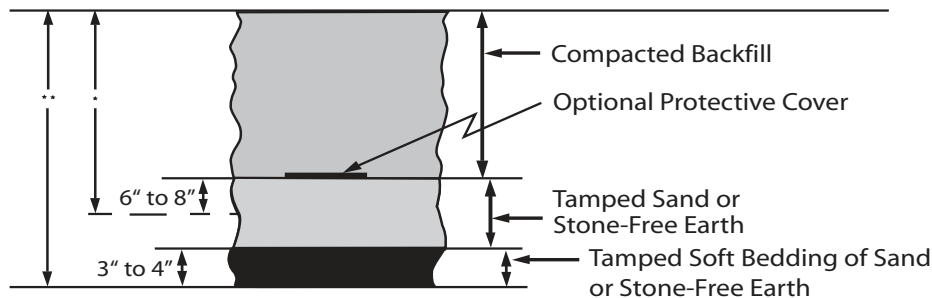

Figure F-18
Typical Burial Cross-Section

TABLE 10

NESC TABLE 352-1 SUPPLY CABLE OR CONDUCTOR BURIAL DEPTH		
Voltage Phase to Phase	Depth of Burial	
	(in.)	(mm)
0 to 600	24	600
601 to 50,000	30	750
50,001 and above	42	1070

EXCEPTION: Street light cables operating at not more than 150 V to ground may be buried at a depth not less than 18 in. (450mm).

- a. In area where frost conditions could damage cables, burial depths should be greater.
- b. Lesser depths may be used where supplemental protection is provided. The supplemental protection should be sufficient to protect the cable from damage imposed by expected surface usage.
- c. Where the surface is not to final grade, the cable should be placed to meet or exceed the requirements indicated above, both at the time of installation and when the surface is to final grade.

Trenching

The bottom of the trench should be smooth, undisturbed, well-tamped earth or sand. When excavation is in rock or rocky soils, the cable should be laid on a protective layer of well-tamped backfill. Backfill within 4 inches of the cable should be free of materials that may damage the cable. Backfill should be adequately compacted. Machine compaction should not be used within 6 inches of the cable.

A protective covering above the cable will warn excavators of the presence of an underlying cable.

⁵NEC, section 300.5; National Electrical Safety Code (NESC), 2002 edition, section 35; ANSI C2-2002, Secretariat IEEE."

Plowing

Plowing of cable should not result in damage to the cable from rocks or other solid materials. The design of cable plowing equipment and the plowing of cable should not damage the cable by exceeding bend, sidewall pressure, cable tension, or other allowable limits.

Supplemental Information

A jacketed multiconductor is preferable to the installation of single-conductor cables to ease installation and avoid crossovers.

Under vehicular and pedestrian traffic ways, it is good practice to pull cable through a conduit.

AERIAL INSTALLATION

Sag and Tension

This information is intended for initial design information only. The cable manufacturer can supply detailed data, which include thermal expansion and creep. These factors increase the arc length after initial stringing, resulting in an increased sag.

The calculation for sag and tension is based on the equation for parabolas. This equation closely approximates a catenary curve for small deflections, as given by:

$$T_H = \frac{s^2 w}{8d} \text{ pounds} \quad (\text{E-36})$$

where: T_H = horizontal tension in conductor or messenger, in pounds

s = length of span between supports, in feet

w = weight of cable assembly, includes supporting conductor/
messenger, saddles, lashings, etc., in pounds per foot

d = sag, in feet

The total messenger tension, at its support, consists of a horizontal and a vertical component. The vertical component has been neglected.

The tension shall not exceed:

- a) 50% of rated breaking strength of the messenger under the assumed ice and wind loading
- b) 25% of rated breaking strength for final unloaded tension at 60°F (15°C)

Ice and Wind Loading

Ice and wind loading on aboveground cables and conductors are determined by location. The NESC divides the United States into three loading districts—Light, Medium, and Heavy.

The weight of the ice, force of the wind, and resultant weight of the cable can be calculated by the following equations.⁶

$$i = (1.24) \cdot (t) \cdot (D + t) \quad (\text{E-37})$$

$$h = \frac{P(D + 2t)}{12} \quad (\text{E-38})$$

$$W_L = \sqrt{(w + i)^2 + h^2} + K \quad (\text{E-39})$$

where: i = weight of ice, in pounds per foot

t = thickness of ice, in inches

D = outside diameter of cable, in inches

h = force of wind, in pounds per foot

P = horizontal wind pressure, in pounds per square foot

W_L = resultant weight of loaded cable, in pounds per foot

W = weight of cable only (i.e. without ice), in pounds per foot

K = constant from NESC Table 251-1

Values of t , P , and K are presented in Table 11. This information is extracted from Tables 250-1 and 251-1 of the NESC.

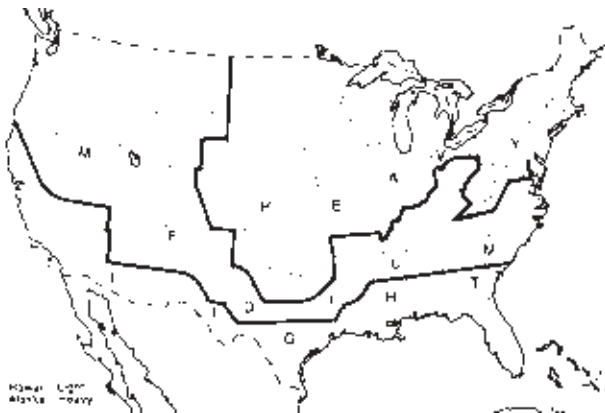

Figure F-19
NESC Loading District Boundaries

⁶Archer E. Knowlton, ed. Standard Handbook for Electrical Engineers, 8th edition (McGraw-Hill, 1949).

TABLE 11

LOADING DISTRICT VARIABLES			
Variables	Loading District*		
	Heavy	Medium	Light
t, radial thickness of ice (in.)	0.50	0.25	0
**P, horizontal wind pressure (Pa)	4	4	9
K, a constant (lb/ft.)	0.30	0.20	0.05
Temperature (°F)	0	15	30

*Figure F-19 presents Loading District boundaries.

** For horizontal wind velocity of 70 mph and above, refer to NESC Table 250-2.

Additional Information

Additional information can be found in ICEA Publication P-79-561 "Guide for Selecting Aerial Cable Messengers and Lashing Wires."⁷

Typical breaking strengths of messengers are presented in the following table:

TABLE 12

MESSENGER CHARACTERISTICS			
Nominal Messenger Size (inch)	Number of Strands	EHS Galvanized Steel	
		Weight (Lb/ft.)	Breaking Strength (lbs.)
1/4	7	0.121	6,650
5/16	7	0.205	11,200
3/8	7	0.273	15,400
7/16	7	0.399	20,800
1/2	7	0.512	26,900
9/16	7	0.671	35,000
9/16	19	0.637	33,700

CABLES UNDER VERTICAL TENSION

ICEA Support Requirements

ICEA suggests that for supported vertical installations, such as vertical shafts or risers and bore holes, the supporting member may be the conductor(s) or the armor wires in wire armored cables.⁸ Strength requirements are expressed in terms of a minimum safety factor (F_s), which is the ratio of rated cable strength to supported cable weight. The equation is:

$$F_s = \frac{NAT}{W\ell} \quad (E-40)$$

where: F_s = safety factor, per Table 9

N = number of conductors

A = cross-sectional area of one conductor or one armor wire, in square inches

T = tensile stress allowed on supporting member from Table 10, in psi

W = weight of cable, in pounds/foot

ℓ = length of cable, in feet

⁷ ICEA P-79-561-1985, "Guide for Selecting Aerial Cable Messengers and Lashing Wires."

⁸ ICEA S-68-516, section 4.5, and IEEE Standard 635-1989, "IEEE Guide for Selection and Design of Aluminum Sheaths for Power Cables."

TABLE 13

SAFETY FACTOR FOR CABLES UNDER VERTICAL TENSION	
Cable Type	Safety Factor F_s
Unarmored	7
Armored Riser & Shaft	7
Armored Borehole	5

TABLE 14

MAXIMUM STRESS ALLOWED ON SUPPORTING MEMBERS	
Materials	Tensile Stress, (T) psi
Annealed Copper	24,000
Medium Hard Copper	40,000
Aluminum 1350	17,000
Armor Wire, Galvanized Steel	50,000

Support can be achieved by cable clamps that will not damage cable components. The spacing (S) of clamps can be determined by using the following equation which results in an approximate value.

$$S = \frac{9DL}{W} \text{ feet} \quad (\text{E-41})$$

where: D = outer diameter of cable in inches

L = length of clamp along cable axis in inches

W = weight of cable in pounds/foot

NEC Support Requirements

The NEC defines support in vertical raceways — one vertical support at the top, or as close as practical, plus a support for each spacing interval as defined in Table 15.

TABLE 15

NEC TABLE 300.19 (A) SPACING FOR CONDUCTOR SUPPORTS*			
Size of Wire AWG or kcmil	Support of Conductors in Vertical	Aluminum or Copper-Clad Aluminum	Copper
18 AWG through 8 AWG	Not Greater Than	100 feet	100 feet
6 AWG through 1/0 AWG	Not Greater Than	200 feet	100 feet
2/0 AWG through 4/0 AWG	Not Greater Than	180 feet	80 feet
Over 4/0 AWG through 350 kcmil	Not Greater Than	135 feet	60 feet
Over 350 kcmil through 500 kcmil	Not Greater Than	120 feet	50 feet
Over 500 kcmil through 750 kcmil	Not Greater Than	95 feet	40 feet
Over 750 kcmil	Not Greater Than	85 feet	35 feet

* Reprinted with permission from NFPA 70-2-5, the National Electric Code®, Copyright 2005, National Fire Protection Association, Quincy, MA 02269. This reprinted material is not the complete and official position of the National Fire Protection Association on the referenced subject which is represented only in the standard in its entirety.

FIELD REMOVAL OF MOISTURE FROM POWER CABLES

Normally, cable ends are sealed until the cable is installed to prevent moisture from entering the cable. When open cable ends are submerged or exposed, water can migrate inside the cable. If water remains in a medium-voltage cable, it can accelerate insulation deterioration and lead to premature failure.

You can remove water from wet cable by purging the cable with dry nitrogen gas under pressure. Any wire or cable product that does not contain fillers and is suitable for wet locations, can be purged under engineering supervision.

If you do have to purge a length of wire or cable, always test it before you energize it. At a minimum, conduct an insulation resistance test with a megohm-meter.

NOTE: The purging procedures described here assume the water in the wire or cable does **not** contain unusually high concentrations of oils or chemicals, such as may be found in floodwaters. If you suspect that water inside a cable carries unusual contaminants, consult the manufacturer before deciding to continue using the wire or cable. If you are not certain about the source of water in cable, water samples from the cable, the work site, and the manufacturer can be analyzed for mineral content. Comparing mineral contents can, many times, identify the source of the water.

Required Materials

The medium for purging moisture from cable is dry nitrogen gas, available at most welding supply houses. You will need:

1. A cylinder of dry nitrogen gas with a dew point of -60°C .
2. A regulator to reduce the gas pressure to approximately 15 psi.
3. Some 1/4" gas hose—and some hose clamps—to run between the tank and the cable end.
4. A hose nipple to connect the hose to the regulator.
5. A cable cap that fits the cable end and a radiator hose clamp that fits the end cap.
6. An automobile tire valve stem assembly—with no valve core installed—to connect the hose to the cable cap.
7. Plastic bags to enclose gas-exit end of the cable. One-gallon bags are a good size.
8. Color indicating desiccant: anhydrous cupric sulfate or Silica Gel desiccant. Cupric sulfate is available from laboratory supply houses. These desiccants absorb water and change color—to either off-white or pink—when exposed to moisture.

General Purging Process

The purging setup is shown in Figure F-20. To purge several cables at once, connect them to the gas supply with a manifold, as shown in Figure F-21. If only one end of the cable contains water, apply purging gas to the dry end. If the whole cable is wet, apply purging gas to the higher end.

Always purge the cable shield separately from the insulated strands. If you try to do them at the same time, the gas will flow only through the path offering the least resistance. Before purging installed cables, remove cable terminations and splices. Do not try to purge across or through splices.

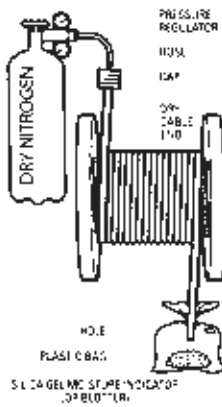

Figure F-20
Cable Purging Setup

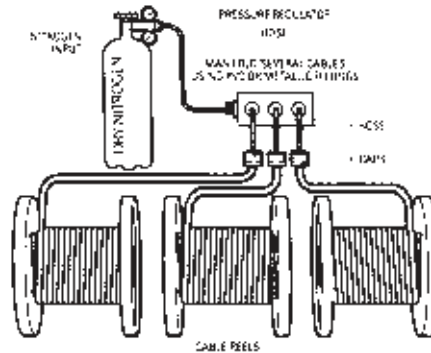

Figure F-21
Multiple Cable Purging Setup

Purging Cable Conductors

1. Select an end cap that fits over the cable core.
2. Cut a hole in the end cap for the valve stem and install the valve stem.
3. At the dry (or higher) cable end, apply two layers of half-lapped high voltage insulating tape as a sealing cushion for the end cap.
4. Install the end cap on the cable using the radiator hose clamp.
5. Connect the low pressure side of the nitrogen regulator to the end cap with the gas hose.
6. Turn on the nitrogen and adjust the regulator to 15 psi.
7. If water is not running or dripping out of the open cable end, sprinkle a tablespoon of color-indicating desiccant into a plastic bag and tape or clamp the bag to the open cable end.
8. Check to make sure the bag is filling with nitrogen. If it is, make a small vent hole by clipping off one corner of the bag.
9. After a few hours, check the desiccant to see if it has changed from the blue to off-white or pink. This indicates moisture coming out of the cable. If the desiccant has changed color, replace it with fresh desiccant and continue purging. (You can also check for moisture by holding a piece of tissue or blotter paper next to the vent hole for a few minutes. If the paper gets damp, moisture is still coming out of the cable.)
10. Change the desiccant every few hours until it stops changing color. When you have gone several hours with no sign of moisture, you can assume the cable is dry. Depending on how much moisture is in the cable, purging may take up to eight hours—occasionally even longer. One cylinder of nitrogen should be enough for at least one cable run.

You can also drive water vapor from conductor strands by lightly loading the cable with low voltage and low current. This process does **not** dry out the shield assembly. The cable terminations must have an open strand design or terminations must be removed to let the water vapor escape.

Purging Cable Shield

You can purge cable shield systems by following the conductor purging process with the following exceptions: (1) block the conductor strands so no gas can pass through them, and (2) place end caps over the jacket rather than the cable core. Apply gas pressure and check for moisture as before. Do not exceed 15 psi maximum.

Cable on Reels

You will have to unlash the cable ends to connect the purging set-up to cables on reels. If you find water in only one end of a reel of cable, position the reel so the wet end is in its lowest possible elevation. If you see moisture at both ends of the cable, position the inside end of the cable as low as possible and purge from the outer end of the cable.

FIELD TESTING

The purpose of this section is to summarize procedural and technical information for the performance of field testing cable systems. The procedural aspects cover subjects related to personnel and safety, but are not intended to be all-inclusive.

Manufacturers perform various electrical tests on finished wire and cable products to ensure they can safely handle their maximum voltage and current ratings. Some installation procedures—such as pulling through conduit, installation into cable trays, or framing members— can damage conductors and cables enough to create an electrical hazard. For example, incorrect calculations of pulling force, sidewall pressure, or conduit fill may lead to the tearing of a conductor's insulation as it is pulled through conduit. Because post-installation testing is a good general practice, some installation contracts may require testing by the installer.

Safety

Electrical tests can be dangerous and should be conducted by personnel who are qualified to perform the tests. Both low-potential and high-potential testing have inherent hazards to personnel and equipment. Thus, a thorough understanding of the safety rules, test equipment, wiring system, and connected equipment is essential in preventing damage to the conductors and equipment, and in preventing electrical shock to the persons performing the tests. IEEE Standard 510 typifies recommended industry practices for safely conducting field testing.⁹

⁹ IEEE Standard 510-1992, "Recommended Practices for Safety in High Voltage and High Power Testing."

Preparation for Testing

Before conducting tests on any cable system, verify that the cable system is properly de-energized. If the cable system has been previously energized, you must follow the prescribed rules for conducting the switching necessary to de-energize, lock-out, tag, and ground the cable system.

High-voltage conductors that are energized can induce voltage in ungrounded conductors in close proximity. It is good practice, therefore, to disconnect cables from non-cable system equipment and to ground all conductors not under test for safety concerns and to prevent erroneous test results. In the case of High-Voltage testing, disconnecting the cable will prevent damage to equipment and apparatus.

Check that adequate physical clearances exist between the cable ends and other equipment, other energized conductors, and to electrical ground.

At all ends remote from where the test equipment is to be connected, position a personnel guard, or barricade the area to prevent unauthorized access to the cable system under test.

NOTE: Verify the procedures are taken to clear all tap(s) or lateral(s) in the circuit.

Remove grounds from the cable phase to be tested. Phases not under test are to remain grounded at all ends.

Conducting Test

Follow the instructions provided by the manufacturer of the test equipment for its proper operation.

Conduct test in accordance with prescribed procedures and instructions.

Record test results and retain for future reference.

Conclusion of Testing

Maintain grounds on all conductors until the test equipment is disconnected and packed for removal.

Caution: For HVDC tests, the accumulation of a potentially dangerous voltage can remain on the cable system if the conductors have not been grounded for a sufficient time period after the completion of the test. A rough guide is to maintain the grounds for one to four times the test duration before they are removed and the cable is reconnected into the circuit.¹⁰

Follow prescribed procedures to return or place the cable circuit into service.

¹⁰ IEEE Standard 400-1991. "Guide for Field Testing and Evaluation of the Insulation of Shielded Power Cable Systems."

Cable System Integrity

During the design of the power cable system, it is appropriate to evaluate the requirements of the field acceptance tests that can determine the integrity of the installed system. The following types of tests may be readily conducted:

Conductor Continuity

Tests for conductor continuity can include a simple check with an ohmmeter, 500-Volt megohm meter, or a device that measures conductor resistance. This test determines if the conductors complete an electrical circuit by ensuring the conductor metal has not been broken.

Dielectric Condition of the Cable

The electrical integrity of the system dielectric can be measured by the use of ohmmeters or megohm meters for insulation resistance. A more complex high-voltage dc test, commonly referred to as a dc high-pot test, can also be done to evaluate "leakage currents."

Metallic Shield Condition

For shielded cables, the metallic component of the insulation shield of jacketed cables can be tested for its condition. A continuity test can be accomplished with an ohmmeter or megohm meter tester. A more complex test arrangement is required to measure the value of the shield resistance. A comparison of the shield resistance value can then be made against specified values..

Jacket Integrity

Insulating jackets of directly-buried or water-submerged cables can be tested for insulation resistance (IR). It may be possible to test integrity of conductive, non-metallic jackets or sheaths.

Low Potential Testing of Dielectric

Insulation Resistance (IR)

The IR of the insulation components of the cable system is commonly tested using an unidirectional (dc) potential as opposed to using the ac operating frequency. Low voltage, nonshielded cables can be tested using a battery-powered ohmmeter. The reading from an ohmmeter for shielded higher voltage cables may be questionable as it does not have the capability to promote an inherent defect into an electrical fault, even though it can detect a low-resistance or bolted fault.

A megohm meter is commonly employed for the detection of questionable conditions in shielded and nonshielded cables.

Equipment and Voltage Output

Hand-held ohmmeters generally have outputs from 6 to 24 volts. They are excellent for detecting direct “shorts” such as bolted faults and low-resistance measurements in the kilohm range.

Manual- or motor-driven megohm meters are available for a range of fixed dc voltages. Typical fixed dc voltages are 500, 1000, 2500, and 5000 volts. These instruments are also available with multi-voltage selections within the same device.

Interpretation of Results

Industry practice recognizes tests with a dc potential of 500 or 1000 volts dc. The insulation resistance reading should be taken after 1 minute to allow the reading to stabilize.

- For spot short time readings, IR readings should be evaluated with respect to the test conditions to determine if the results should be considered acceptable. IR readings can vary greatly depending on the environmental conditions. Conditions such as humidity, moisture in the conduits, and leftover residue on the conductor from pulling compounds are among some of the factors that influence IR readings and make detection of problems more difficult. The following “2 to 50 Megohm Rule” is a good indicator to use for evaluating IR readings:

Acceptable: A megohm meter reading of 50 megohms or higher should be considered acceptable.

Investigate: A megohm meter reading of 2 to 50 megohms may be used for deciding when to investigate the cable installation. In most cases, a 2 to 50 megohm reading does not indicate the insulation quality, therefore, 2 to 50 megohms should not be specified as a pass/fail value. These readings are usually associated with long circuit lengths, moisture, or contamination. Ends of conductors that are dirty or damp may need to be cleaned and dried.

Unacceptable: Readings less than 2 megohms will most likely indicate damaged insulation or severe test conditions.

- A more technically-oriented evaluation is to use the “time-resistance” technique. Good insulation shows an increasing IR with respect to time at a constant dc voltage. This is commonly called an “absorption” test.
- Some credence is given to determining the “dielectric absorption ratio.” This is the ratio of the 60-second megohm meter reading divided by the 30-second reading. This method is common for coil insulation, but is not widely accepted for cable system insulation.
- Some standards recognize a “polarization index.” This method typically is a 10-minute reading divided by the 1-minute reading.
- For tests requiring several seconds to minutes, it is important that the voltage be constant. Typically, a motor-driven megohm meter is used.

If further sophistication is desired, use the previous techniques at varying voltage levels. A downward trend of results at a higher voltage(s) is an indication of a questionable condition.

High-Voltage Withstand Testing

High-voltage withstand tests help determine whether a conductor can withstand a prescribed test voltage without breakdown or failure. One way to ensure that a conductor is free from major defects or installation damage is to test it at a higher ac or dc voltage than the maximum operating voltage of the conductor. The cable either withstands the voltage or it breaks down. The test does not indicate how close the cable came to failure.

High-Potential DC Testing of Dielectric

The normal high-potential testing procedure is to employ direct current voltages.¹⁰ The use of alternating current voltages requires that the test equipment be of sufficient kVA capacity to supply the charging current requirements of the circuit under test. Direct current voltage test equipment is much smaller and lighter than ac test equipment of equivalent test voltage output. Thus, for reasons of economics and handling, dc test equipment is predominantly used.

It is common practice when conducting high-potential testing to use high-voltage direct current levels (HVDC). For these situations, personnel should be familiar with IEEE Standard 400.¹⁰

Withstand Test

During Installation

Tests should be conducted on the cable prior to installation for damage that may have occurred during transit and subsequent handling. This minimizes labor and productivity losses. Applicable cable specifications define limitations on voltage and time of test. These limitations are generally within those presented in IEEE Standard 400.

Field Acceptance

After installation of the cable and prior to installing terminations or splices, it is recommended to test the cable for possible damage that may have occurred during installation. This test can be performed at a reduced level as defined in the applicable specification. The cable system may be subjected to a final acceptance test after the system is assembled, terminated, and spliced, and before connection to any non-cable equipment or devices. This test will reveal any errors in final termination of the cable system. As for the previous test, applicable specifications define voltage and time limits. These specifications also are generally within those presented in IEEE Standard 400.

Periodic Maintenance

Although not a design criteria, this topic is presented here for completeness on the types of HVDC tests that can be conducted. After the system has been in service, some organizations conduct periodic tests as a maintenance procedure to evaluate any possible deterioration of the system dielectric.

¹⁰IEEE Standard 400-1991. "Guide for Field Testing and Evaluation of the Insulation of Shielded Power Cable Systems."

Interpretation of Results

With any HVDC testing, it is highly recommended that IEEE Standard 400 be understood and that the manufacturers of the cables, terminals, and splices concur prior to the performance of any proposed testing.

The test voltages and times for HVDC tests are defined in IEEE Standard 400. For convenience, Table 16 is a reproduction of a part of Table 4 of IEEE Standard 400.

TABLE 16

FIELD TEST VOLTAGES FOR SHIELDED POWER CABLE SYSTEMS FROM 5 KV TO 35 KV SYSTEM VOLTAGE			
System Voltage (kV rms) (phase-phase)	System BIL (kV) (crest)	Acceptance Test Voltage* (kV dc) (cond-gnd)	Maintenance Test Voltage* (kV dc) (cond-gnd)
5	75	28	23
8	95	36	29
15	110	56	46
25	150	75	61
28	170	85	68
35	200	100	75

*Acceptance test voltage duration is normally 15 minutes. Maintenance test voltage duration is normally not less than 5 minutes or more than 15 minutes.

IEEE Standard 400 tests are “go, no-go” tests. The system is required to withstand the specified voltage for the specified time duration. These tests will normally reveal gross imperfections resulting from improper field handling, such as excessive bending or air gaps between the insulation and shield interfaces.

TABLE 17

DC TEST VOLTAGES AFTER INSTALLATION PER ICEA¹¹			
Rated Circuit Voltage (Phase-to-Phase Voltage in Volts)	Conductor Size (AWG or kcmil)	Maximum dc Field Test Voltage (kV)	
		100 Percent Insulation Level	133 Percent Insulation Level
2001-5000	8-1000	28	28
	1001-3000	28	36
5001-8000	6-1000	36	44
	1001-3000	36	44
8001-15000	2-1000	56	64
	1001-3000	56	64
15001-25000	1-3000	80	96
25001-28000	1-3000	84	100
28001-35000	1/0-3000	100	124
35001-46000	4/0-3000	132	172

DC test voltages are applied to discover gross problems, such as improperly installed accessories or mechanical damage. DC testing is not expected to reveal deterioration due to aging in service. Evidence exists that dc testing of aged cables can lead to early cable failure. For alternative testing methods of dc testing, consult IEEE P-400. The dc voltage proof test shall be made immediately after installation, not exceeding the maximum specified value. The voltage shall be applied between the conductor and the metallic shield with the shield and all other metallic components of the cable grounded. The rate of increase from the initially-applied voltage to the specified test voltage shall be approximately uniform and shall not be more than 100 percent in 10 seconds nor less than 100 percent in 60 seconds.

The duration of the dc voltage test shall be 15 minutes.

¹¹ ICEA S-93-639 (NEMA WC 74-2000): “5 - 46 kV Shielded Power Cable for Use in the Transmission & Distribution of Electric Energy.”

Time-Leakage Test

For more sophisticated evaluations, it is important to recognize the components of dc "leakage" current. The output current of the test set into the cable is not the true leakage current. The output current is the sum of three currents: geometric capacitance, absorption, and true leakage current. The absolute value of output current is not of primary importance. This value is virtually impossible to predict and is dependent upon the previously mentioned factors, which can affect the resultant output current from a few to hundreds of microamperes.

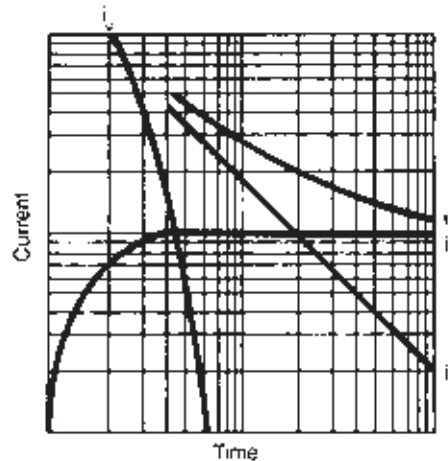

Figure F-22
Components of DC Test Output Current

$$\text{where: } i_t = i_a + i_g + i_c$$

$$i_g = \text{geometric capacitance current}$$

$$i_a = \text{absorption current}$$

$$i_c = \text{leakage/conduction current}$$

$$i_t = \text{total current}$$

The shape of the total current curve (i_t) with respect to time indicates the condition of the dielectric. A drop-off of current with respect to time is an indication of sound insulation. A distinct or fast-rising current is an indication of questionable condition, or impending failure. A flat curve is generally a result of test conditions.

The output current variation with respect to time of voltage application is generally considered more indicative than the absolute value. The characteristic shapes of the time-leakage current curve and probable causes are outlined below.

1. A **fast-rising leakage curve at a steady voltage** may be indicative of faulty insulation. However, other leakage paths (over porcelain surfaces and through insulating fluids) can contribute to such a result.
2. A **falling leakage curve** is indicative of good insulation characteristics especially if it is at similar levels for all phases.

3. A **flat leakage curve** at low value is generally indicative of acceptable insulation. Flatness may be influenced by circuit length, cable geometry, and possible presence of moisture or contaminants over terminal surfaces.

4. A **flat leakage curve** at high value may indicate any of the following conditions:
 - a. presence of moisture
 - b. contaminants over terminal surfaces or other creepage surfaces
 - c. surface leakage greater than volume leakage
 - d. moist laminated insulation
 - e. condition of insulating fluids
 - f. air ionization losses (corona) from projections

5. **Dissimilar leakage curves** are indicative of non-uniformity of circuit insulation. The characteristic curve of each phase should be analyzed to determine the cause of dissimilarity. Air ionization losses from projections may affect one phase more than the others, dependent upon corona shielding (such as at terminals), temperature and humidity transients, air movement, and the like.

Generally speaking, the increase of current with test voltage is approximately linear for sound insulation. Care should be exercised to prevent terminal corona and minimize terminal surface leakage as these can mask test results.

REFERENCE PUBLICATIONS

R.C. Rifenberg, "Pipe Line Design for Pipe Type Feeders," in "AIEE Transactions on Power Apparatus and Systems" (December 1953), volume 8, paper no. 53-389.

ANSI/IEEE Standard 525-1992, "IEEE Guide for the Design and Installation of Cable Systems in Substations." ANSI/IEEE Standard 690, "IEEE Standard for the Design and Installation of Cable Systems for Class 1E Circuits in Nuclear Power Generating Stations. 2002."

T.A. Balaska and A.L. McKean, "Fault Location Experience and Practice on Industrial Systems," 1966 IEEE Special Technical Conference on Underground, Chicago, IL.

1. IEEE 532-1993 "Guide for Selecting and Testing Jackets for Underground Cables."

2. Polywater, "Technical Talk," volume 4.

3. AEIC Publication no G5-90, "Underground Extruded Power Cable Pulling, AEIC Task Group 28," 2nd edition, May 2001; and IEEE Standard 1185-1994, "Guide for Installation Methods for Generating Station Cables."

4. Gene C. Neetz, "Coefficient of Friction Measurement Between Cable and Conduit Surfaces Under Varying Loads," in 1985 IEEE Transactions on Power Apparatus and Systems, vol. PAS-104, no. 1, pp. 16-21.

5. NEC, section 300.5; National Electrical Safety Code (NESC), 2002 edition, section 35; ANSI C2-2002, Secretariat IEEE."

6. Archer E. Knowlton, ed. Standard Handbook for Electrical Engineers, 8th edition (McGraw-Hill, 1949).

7. ICEA P-79-561-1985, "Guide for Selecting Aerial Cable Messengers and Lashing Wires."

8. ICEA S-68-516, section 4.5, and IEEE Standard 635-1989, "IEEE Guide for Selection and Design of Aluminum Sheaths for Power Cables.

9. IEEE Standard 510-1992, "Recommended Practices for Safety in High Voltage and High Power Testing."

10. IEEE Standard 400-1991. "Guide for Field Testing and Evaluation of the Insulation of Shielded Power Cable Systems."

11. ICEA S-93-639 (NEMA WC 74-2000): "5 - 46 kV Shielded Power Cable for Use in the Transmission & Distribution of Electric Energy."

INSTALLATION



Southwire Company
Electrical Division
102 City Hall Avenue, Carrollton, Georgia 30117, USA
800.444.1700