



Technical catalog

Distribution boards Classic range

Index

Contents	Page no
Classic series – Distribution Boards	4
Classic series – SPN-SHC	5
Classic series – SPN-SHC – Dimensional drawing	6
Classic series – TPN-SHDB	8
Classic series – TPN-SHDB – Dimensional drawing	9
Classic series – Per Phase Isolation DB-SHPPI (Horizontal)	13
Classic series – Per Phase Isolation DB-SHPPI – Dimensional drawing	14
Classic series – Per Phase Isolation DB-SVDB (Vertical)	18
Classic series – Per Phase Isolation DB-SVDB – Dimensional drawing	19
Classic series – Vertical DB – SVTDB-MCB I/C	20
Classic series – Vertical DB – Dimensional drawing	21
Classic series – Vertical DB-SVTDB T1	23
Classic series – Vertical DB-SVTDB T1 – Dimensional drawing	24
Classic series – Vertical DB-SVTDB T3	26
Classic series – Vertical DB-SVTDB T3 – Dimensional drawing	27
Classic series – Flexi Tier DB-SVFL	29
Classic series – Flexi Tier DB-SVFL – Dimensional drawing	30
Classic series – 7 segment MCB I/C DB-S7SEG	31
Classic series – 7 segment MCB I/C DB-S7SEG – Dimensional drawing	32
Classic series – 7 Segment MCCB I/C DB-E-S7SEG T1	34
Classic series – 7 Segment MCCB I/C DB-E-S7SEG T1 – Dimensional drawing	35
Classic series – Phase Selector DB-SPVS	37
Classic series – Phase Selector DB-SPVS – Dimensional drawing	38
Classic series – Metal enclosures-SEN	39
Classic series – Metal enclosures-SEN – Dimensional drawing	39
Classic series – Plug and Socket DB – SGK	40

Distribution boards

Classic series

ABB's Classic-series of distribution boards meet all the requirements of modern installations for domestic, commercial and industrial applications

Construction

Blending aesthetics, functionality and safety, the Classic-series of ABB distribution boards are manufactured with high precision and high quality CRCA steel sheets. These distribution boards undergo a seven-tank phosphating process to ensure anti-rust conditioning, superior finish and lasting strength. Premier quality powder coating is applied using the latest techniques

Colour

ABB's Classic-series of distribution boards is available in standard Ivory (RAL 9010)

Installation

The Classic-series of ABB distribution boards are universal mounting Type, hence can be flush or wall mounted. These distribution boards are provided with top and bottom removable gland plates with adequate number of knock outs, which enable easy installation and connection of conduits of sizes up to 32mm diameter.

Protection

Classic-series distribution boards offer three types of protection - IP 43 & IP 54 degree with a metal door and IP 30 degree without a door.

The highest degree of attention has been paid to the safety aspect of the distribution boards, considering that they are installed in close proximity to people. An intermediate plate ensures total safety, as no live parts are exposed when the door is opened



Distribution boards

Classic series – SPN – SHC



Horizontal single phase consumer unit with provision for 2 pole (MCB / Isolator / RCD) incoming and single phase outgoing.

These distribution boards come with earth link, neutral link and tinned electrolytic copper busbar. Top and bottom, removable gland plates with knockouts. Mounting of these boards can be flush or surface.

Available in IP 30 (without door)
IP 43 & IP 54 (with metal door)
IP 43 (Metal door with acrylic)

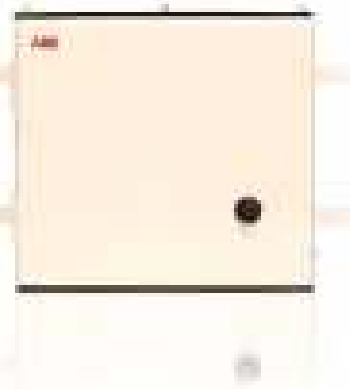

IP 30

Product description	Product code	No of ways	No of modules	
			I/C	O/G
SHC WD 4	1SYN869006R0001	4 way	2	4
SHC WD 6	1SYN869007R0001	6 way	2	6
SHC WD 8	1SYN869008R0001	8 way	2	8
SHC WD 10	1SYN869006R0010	10 way	2	10
SHC WD 12	1SYN869009R0001	12 way	2	12
SHC WD 14	1SYN869010R0001	14 way	2	14
SHC WD 16	1SYN869006R0016	16 way	2	16
SHC WD 20	1SYN869006R0020	20 way	2	20

IP 43 with metal door

Product description	Product code	No of ways	No of modules	
			I/C	O/G
SHC M 4	1SYN869001R0001	4 way	2	4
SHC M 6	1SYN869002R0001	6 way	2	6
SHC M 8	1SYN869003R0001	8 way	2	8
SHC M 10	1SYN869004R0101	10 way	2	10
SHC M 12	1SYN869004R0001	12 way	2	12
SHC M 14	1SYN869005R0001	14 way	2	14
SHC M 16	1SYN869001R0016	16 way	2	16
SHC M 20	1SYN869001R0020	20 way	2	20

IP 43 metal door with acrylic

Product description	Product code	No of ways	No of modules	
			I/C	O/G
SHC P 4	1SYN869011R0041	4 way	2	4
SHC P 6	1SYN869011R0042	6 way	2	6
SHC P 8	1SYN869013R0001	8 way	2	8
SHC P 10	1SYN869013R0002	10 way	2	10
SHC P 12	1SYN869015R0012	12 way	2	12
SHC P 14	1SYN869015R0001	14 way	2	14
SHC P 16	1SYN869011R0161	16 way	2	16
SHC P 20	1SYN869011R0201	20 way	2	20

IP 54

Product description	Product code	No of ways	No of modules	
			I/C	O/G
SHC M WP 4	1SYN869002R0004	4 way	2	4
SHC M WP 6	1SYN869004R0020	6 way	2	6
SHC M WP 8	1SYN869002R0008	8 way	2	8
SHC M WP 10	1SYN869004R0021	10 way	2	10
SHC M WP 12	1SYN869002R0012	12 way	2	12
SHC M WP 14	1SYN869004R0022	14 way	2	14
SHC M WP 16	1SYN869004R0023	16 way	2	16
SHC M WP 20	1SYN869002R0013	20 way	2	20

Distribution boards

Classic series – dimensional drawing

IP 30 SHC WD range

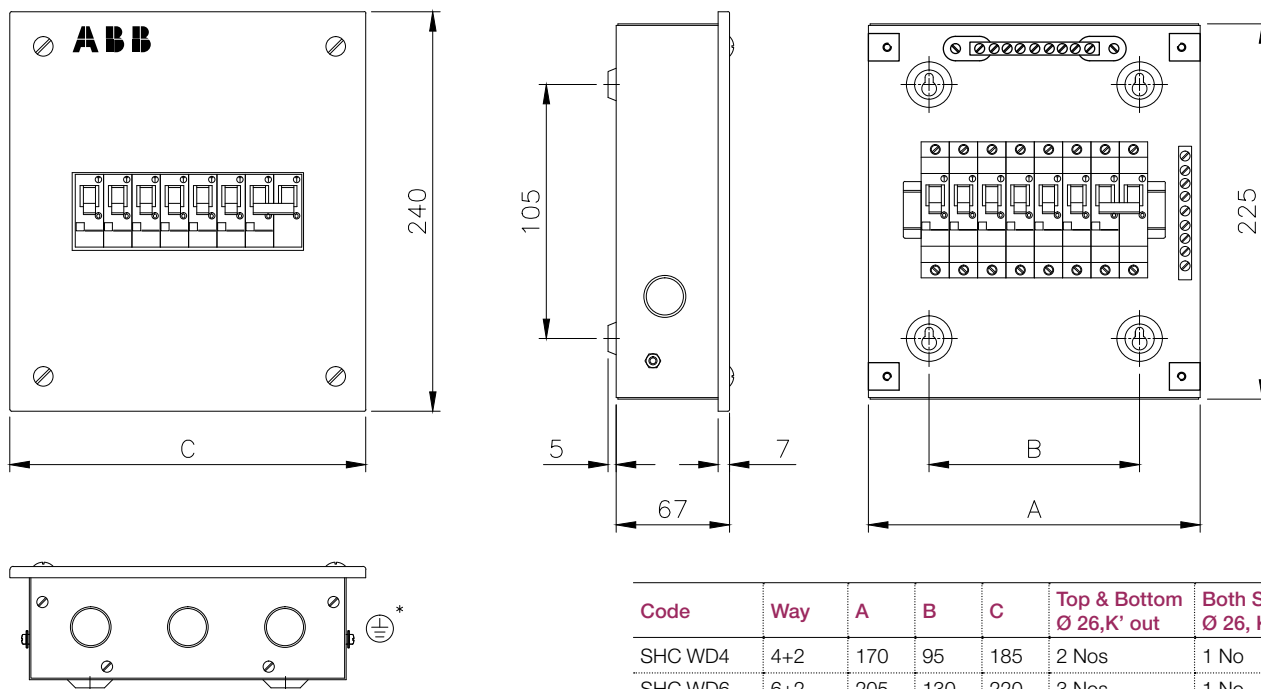

Code	Way	A	B	C	Top & Bottom Ø 26, K' out	Both Sides Ø 26, K' out
SHC WD4	4+2	170	95	185	2 Nos	1 No
SHC WD6	6+2	205	130	220	3 Nos	1 No
SHC WD8	8+2	240	165	255	3 Nos	1 No
SHC WD10	10+2	275	200	290	4 Nos	1 No
SHC WD12	12+2	310	235	325	4 Nos	1 No
SHC WD14	14+2	350	275	365	5 Nos	1 No
SHC WD16	16+2	385	310	400	6 Nos	1 No
SHC WD20	20+2	475	400	490	8 Nos	1 No

IP 43 SHC M range

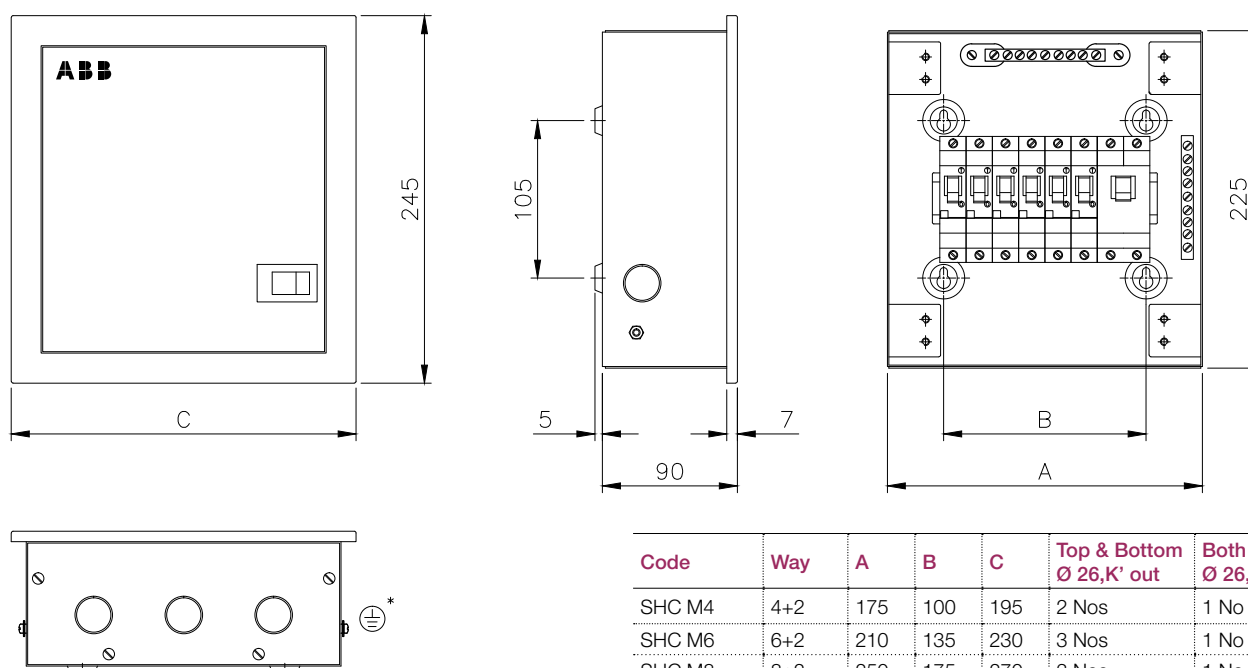

Code	Way	A	B	C	Top & Bottom Ø 26, K' out	Both Sides Ø 26, K' out
SHC M4	4+2	175	100	195	2 Nos	1 No
SHC M6	6+2	210	135	230	3 Nos	1 No
SHC M8	8+2	250	175	270	3 Nos	1 No
SHC M10	10+2	285	210	305	4 Nos	1 No
SHC M12	12+2	325	250	345	4 Nos	1 No
SHC M14	14+2	365	290	385	5 Nos	1 No
SHC M16	16+2	400	325	420	6 Nos	1 No
SHC M20	20+2	475	400	495	8 Nos	1 No

All dimensions are in mm

Distribution boards

Classic series – dimensional drawing

IP 43 SHC P range

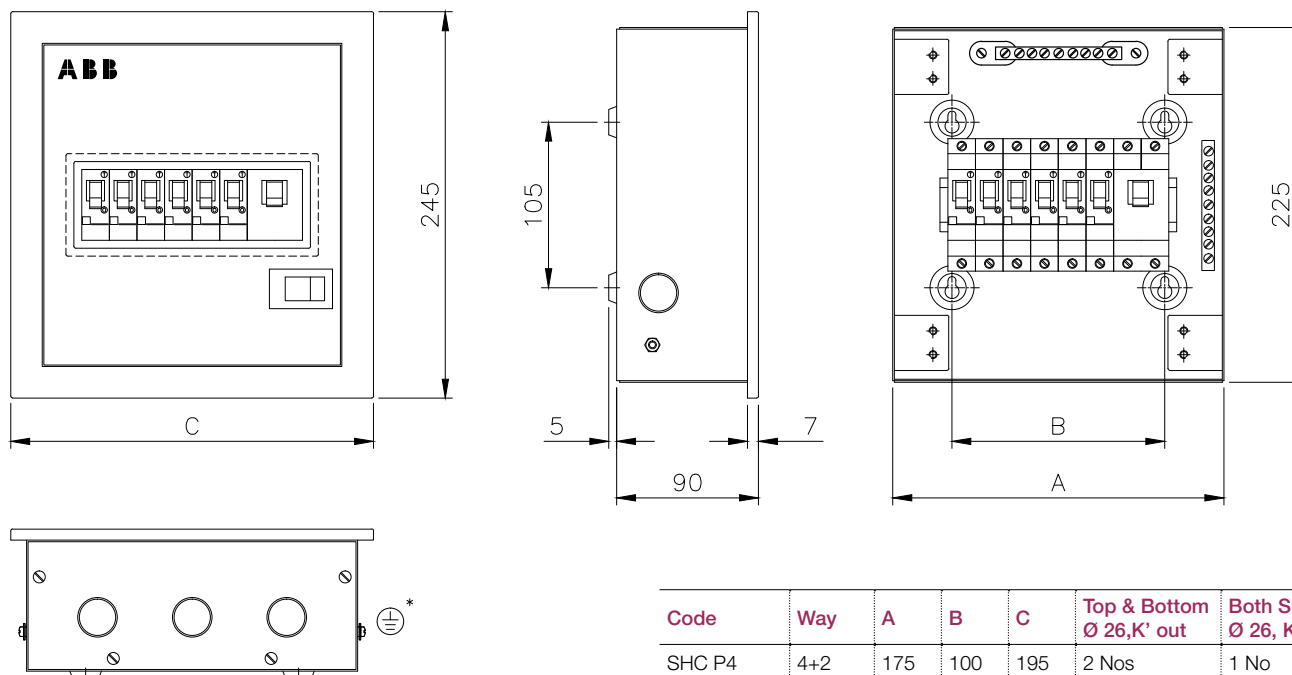

Code	Way	A	B	C	Top & Bottom Ø 26, K' out	Both Sides Ø 26, K' out
SHC P4	4+2	175	100	195	2 Nos	1 No
SHC P6	6+2	210	135	230	3 Nos	1 No
SHC P8	8+2	250	175	270	3 Nos	1 No
SHC P10	10+2	285	210	305	4 Nos	1 No
SHC P12	12+2	325	250	345	4 Nos	1 No
SHC P14	14+2	365	290	385	5 Nos	1 No
SHC P16	16+2	400	325	420	6 Nos	1 No
SHC P20	20+2	475	400	495	8 Nos	1 No

IP 54 SHC M WP range

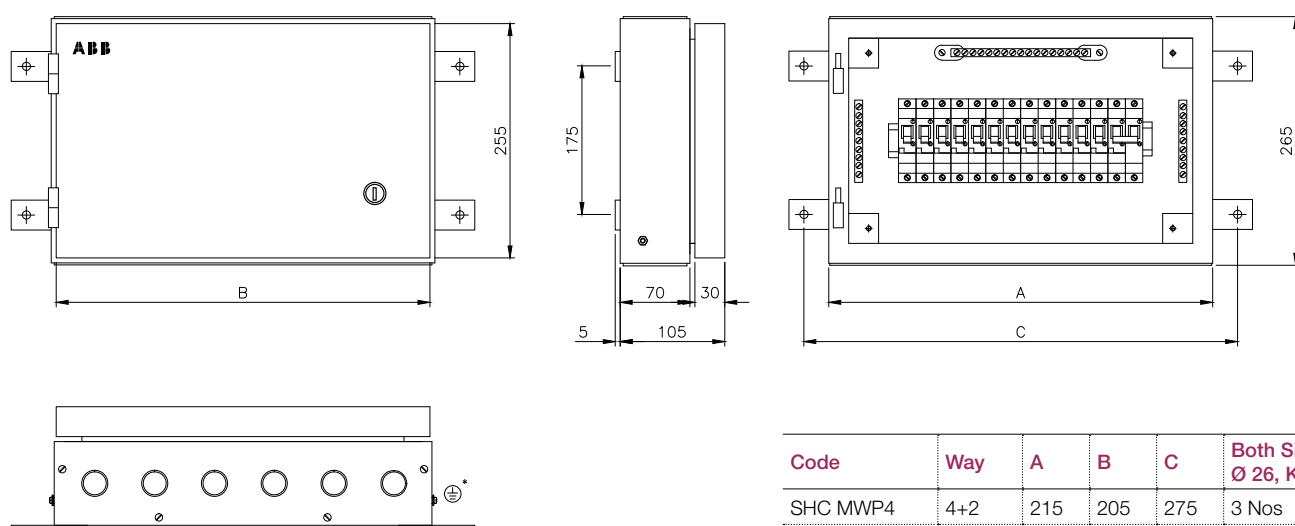

Code	Way	A	B	C	Both Sides Ø 26, K' out
SHC MWP4	4+2	215	205	275	3 Nos
SHC MWP6	6+2	250	240	310	4 Nos
SHC MWP8	8+2	290	280	350	4 Nos
SHC MWP10	10+2	325	315	385	5 Nos
SHC MWP12	12+2	365	355	425	5 Nos
SHC MWP14	14+2	405	395	465	6 Nos
SHC MWP16	16+2	440	430	500	7 Nos
SHC MWP20	20+2	535	525	595	8 Nos

All dimensions are in mm

Distribution boards

Classic series – TPN – SHDB



Horizontal three phase distribution board with provision for incomer 8 pole (MCB / Isolator / RCD) and single phase outgoing.

These distribution boards come with earth link, neutral link, tinned electrolytic copper busbar and wire sets for cable management.

Top and bottom, removable gland plates with knockouts. Mounting of these boards can be flush or surface.

Available in IP 30 (without door)
IP 43 & IP 54 (with metal door)
IP 43 (Metal door with acrylic)



IP 30

Product description	Product code	No of ways	No of modules	
			I/C	O/G
SHDB WD 4	1SYN869020R0001	4 way	8	12
SHDB WD 6	1SYN869021R0001	6 way	8	18
SHDB WD 8	1SYN869022R0001	8 way	8	24
SHDB WD 12	1SYN869023R0001	12 way	8	36
SHDB WD 16	1SYN869004R0024	16 way	8	48



IP 43 with metal door

Product description	Product code	No of ways	No of modules	
			I/C	O/G
SHDB M 4	1SYN869016R0001	4 way	8	12
SHDB M 6	1SYN869017R0001	6 way	8	18
SHDB M 8	1SYN869018R0001	8 way	8	24
SHDB M 12	1SYN869019R0001	12 way	8	36
SHDB M 16	1SYN869004R0025	16 way	8	48

IP 43 with metal door with acrylic

Product description	Product code	No of ways	No of modules	
			I/C	O/G
SHDB P 4	1SYN869024R0001	4 way	8	12
SHDB P 6	1SYN869025R0001	6 way	8	18
SHDB P 8	1SYN869026R0001	8 way	8	24
SHDB P 12	1SYN869027R0006	12 way	8	36
SHDB P 16	1SYN869004R0026	16 way	8	48



IP 54

Product description	Product code	No of ways	No of modules	
			I/C	O/G
SHDB M WP 4	1SYN869001R0004	4 way	8	12
SHDB M WP 6	1SYN869001R0006	6 way	8	18
SHDB M WP 8	1SYN869001R0008	8 way	8	24
SHDB M WP 12	1SYN869004R0027	12 way	8	36
SHDB M WP 16	1SYN869004R0028	16 way	8	48

Distribution boards

Classic series – dimensional drawing

IP 30 SHDB WD range

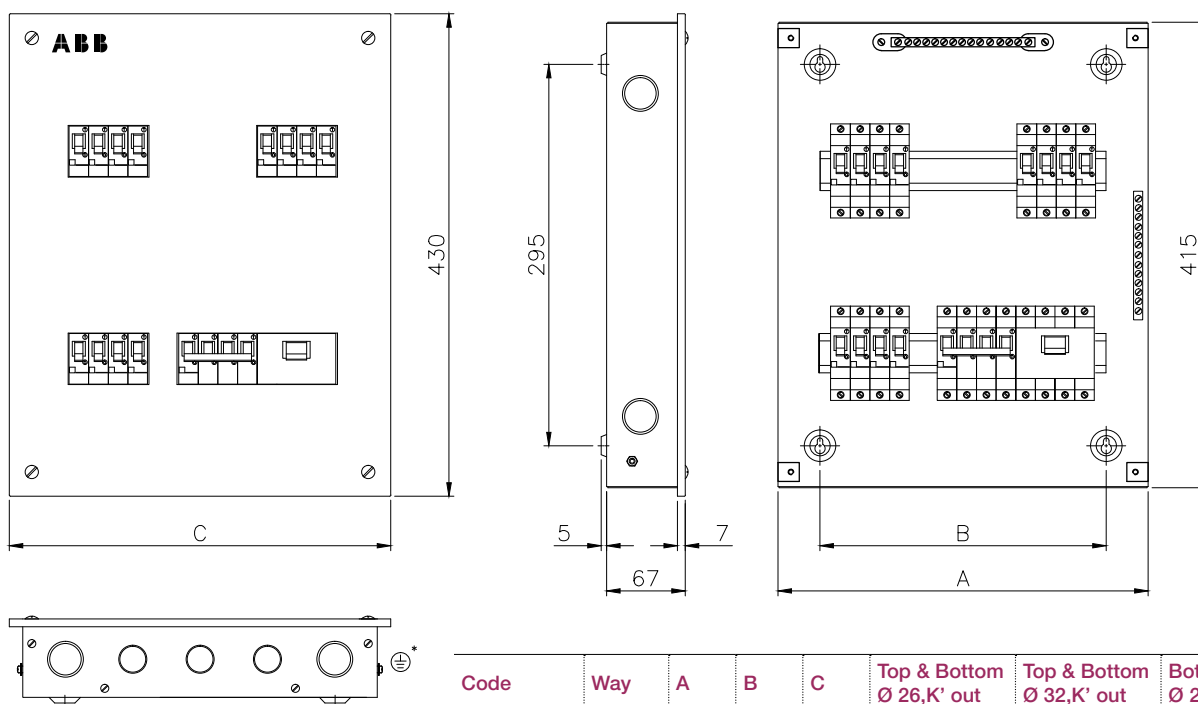

Code	Way	A	B	C	Top & Bottom Ø 26,K' out	Top & Bottom Ø 32,K' out	Both Sides Ø 26, K' out
SHDB WD4	4	330	255	345	3 Nos	2 Nos	2 Nos
SHDB WD6	6	365	290	380	4 Nos	2 Nos	2 Nos
SHDB WD8	8	410	335	425	4 Nos	2 Nos	2 Nos
SHDB WD12	12	555	480	570	7 Nos	2 Nos	2 Nos
SHDB WD16	16	725	650	740	9 Nos	2 Nos	2 Nos

IP 43 SHDB M range

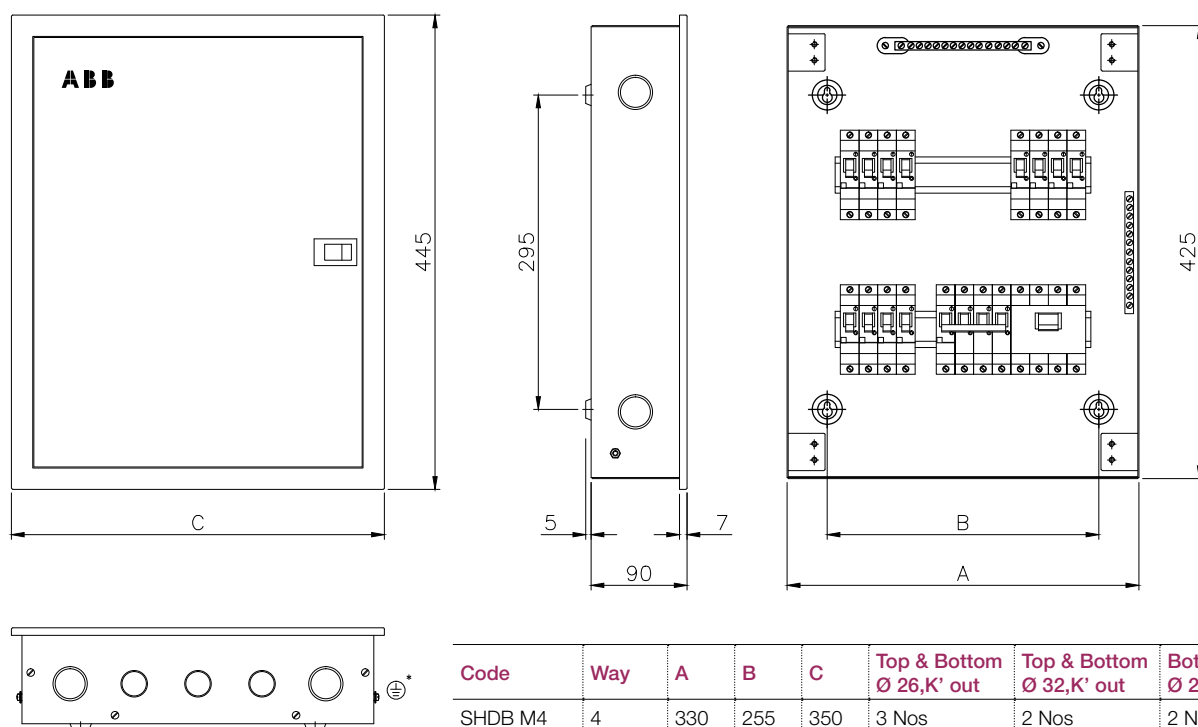

Code	Way	A	B	C	Top & Bottom Ø 26,K' out	Top & Bottom Ø 32,K' out	Both Sides Ø 26, K' out
SHDB M4	4	330	255	350	3 Nos	2 Nos	2 Nos
SHDB M6	6	365	290	385	4 Nos	2 Nos	2 Nos
SHDB M8	8	460	385	480	4 Nos	2 Nos	2 Nos
SHDB M12	12	600	525	620	7 Nos	2 Nos	2 Nos

All dimensions are in mm

Distribution boards

Classic series – dimensional drawing

IP 43 SHDB M 16 range

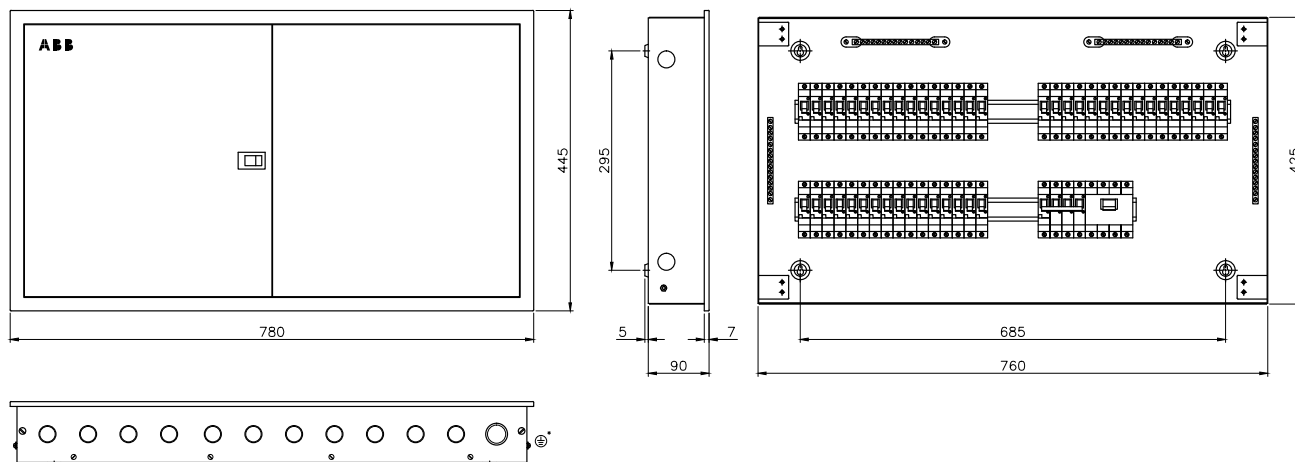

IP 43 SHDB P range

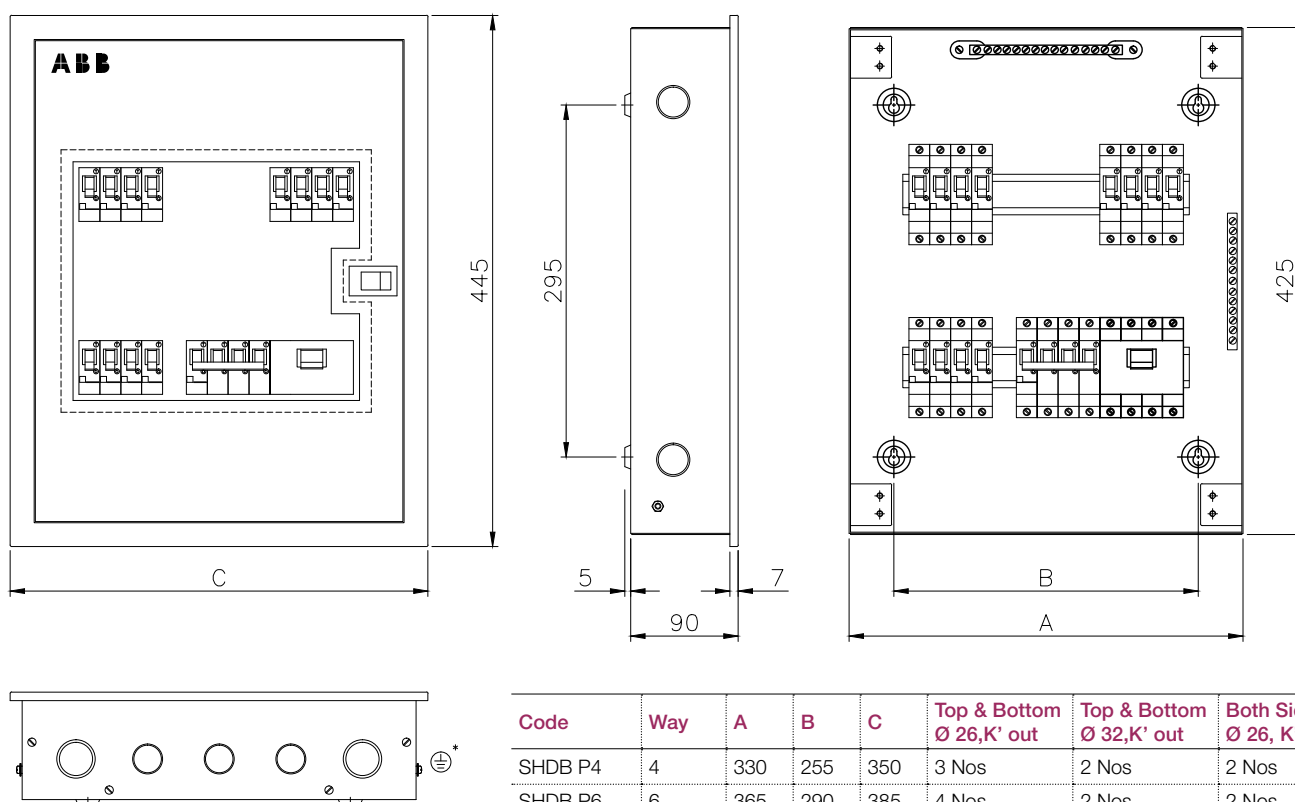

Code	Way	A	B	C	Top & Bottom Ø 26, K' out	Top & Bottom Ø 32, K' out	Both Sides Ø 26, K' out
SHDB P4	4	330	255	350	3 Nos	2 Nos	2 Nos
SHDB P6	6	365	290	385	4 Nos	2 Nos	2 Nos
SHDB P8	8	460	385	480	4 Nos	2 Nos	2 Nos
SHDB P12	12	600	525	620	7 Nos	2 Nos	2 Nos

All dimensions are in mm

Distribution boards

Classic series – dimensional drawing

IP 43 SHDB P 16 range

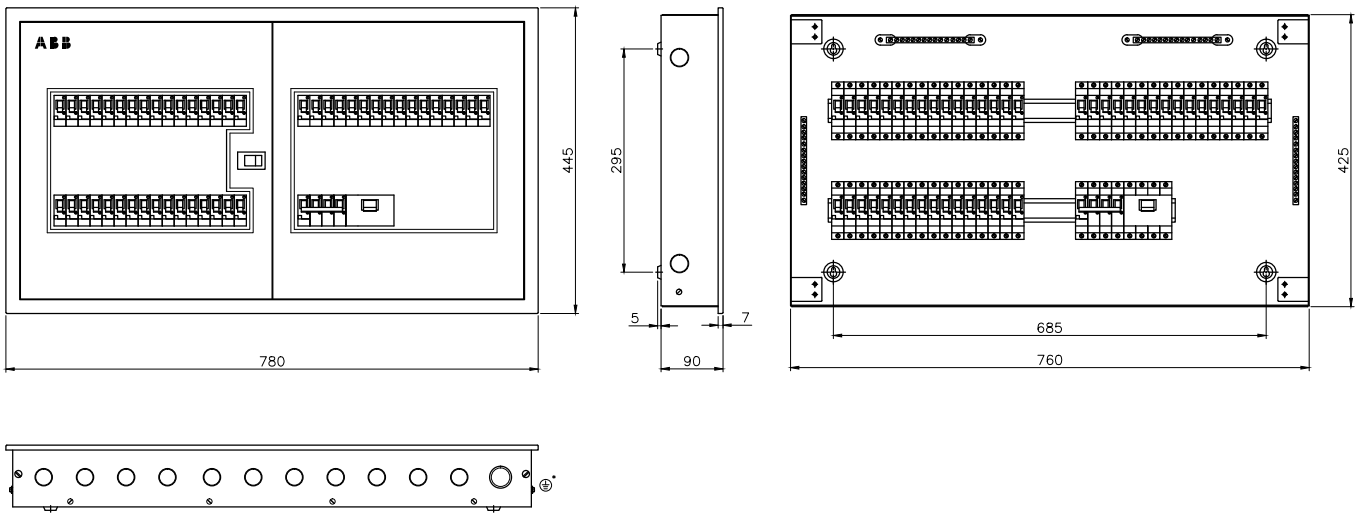

IP 54 SHDB M WP range

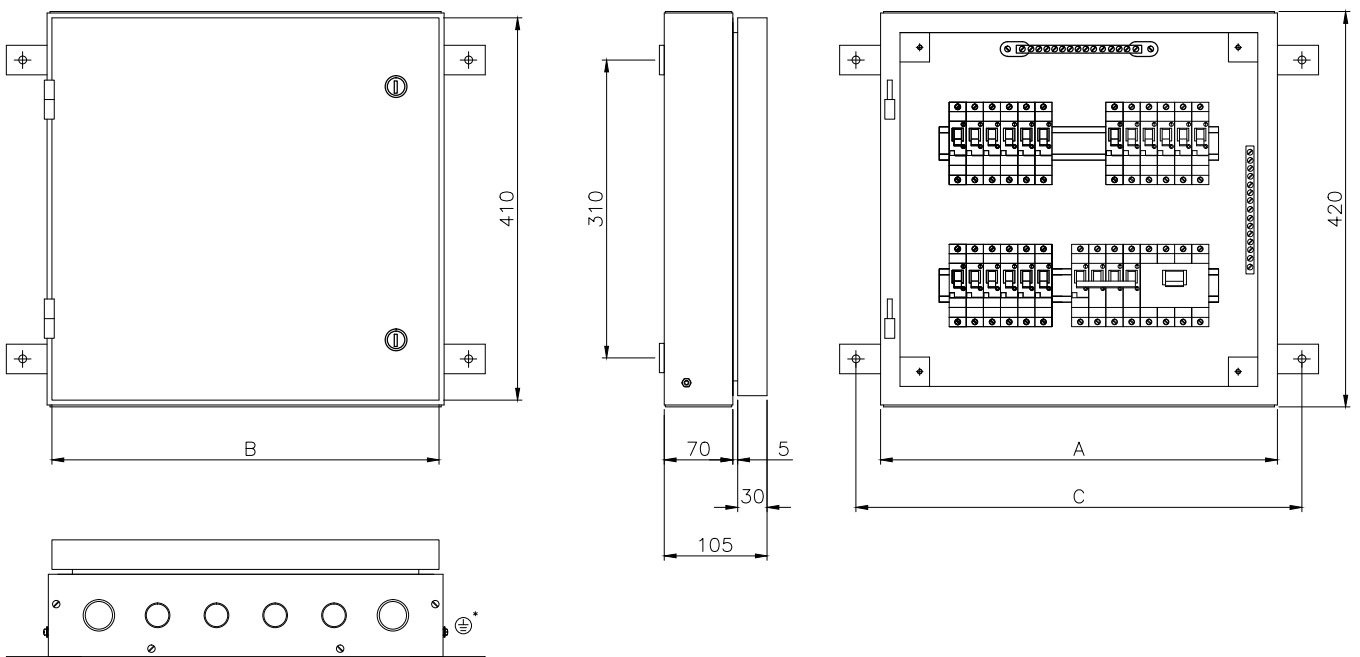

Code	A	B	C	Both Sides Ø 26, K' out
SHDB MWP4	385	375	445	6 Nos
SHDB MWP6	420	410	480	6 Nos
SHDB MWP8	465	455	525	7 Nos
SHDB MWP12	595	585	655	9 Nos

All dimensions are in mm

Distribution boards

Classic series – dimensional drawing

IP 54 SHDB M WP 16 range

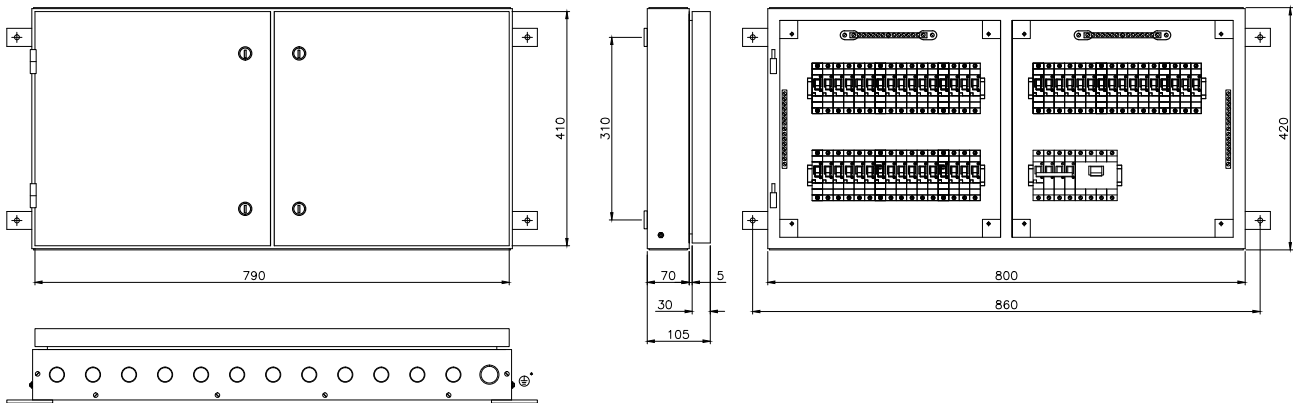

All dimensions are in mm

Distribution boards

Classic series – per phase isolation DB – SHPPI



Horizontal per-phase isolation distribution board with provision for 8 pole (MCB / Isolator / RCD) as incomer, 3 DP MCB / Isolator / RCD as sub-incoming and SP MCBs as outgoing.

These distribution boards come with separate neutral link for each phase, earthing link, tinned electrolytic copper busbar and wire sets for cable management

Top and bottom removable gland plates with knockouts. Mounting of these boards can be flush or surface.

Available in, IP 30 (without door)

IP 43 & IP 54 (with metal door)

IP 43 (Metal door with acrylic)



IP 30

Product description	Product code	No of ways	No of modules		
			I/C	Sub I/C	O/G
SHPPI WD 6	1SYN8690108R0061	6 way	8	6	12
SHPPI WD 8	1SYN8690108R0081	8 way	8	6	18
SHPPI WD 12	1SYN869004R0045	12 way	8	6	30
SHPPI WD 16	1SYN869004R0046	16 way	8	6	42

IP 43 with metal door

Product description	Product code	No of ways	No of modules		
			I/C	Sub I/C	O/G
SHPPI M 6	1SYN8690100R0061	6 way	8	6	12
SHPPI M 8	1SYN8690100R0081	8 way	8	6	18
SHPPI M 12	1SYN8690100R0121	12 way	8	6	30
SHPPI M 16	1SYN8690100R0161	16 way	8	6	42

IP 43 metal door with acrylic

Product description	Product code	No of ways	No of modules		
			I/C	Sub I/C	O/G
SHPPI P 6	1SYN8690101R0061	6 way	8	6	12
SHPPI P 8	1SYN8690101R0081	8 way	8	6	18
SHPPI P 12	1SYN8690101R0121	12 way	8	6	30
SHPPI P 16	1SYN8690101R0161	16 way	8	6	42

IP 54

Product description	Product code	No of ways	No of modules		
			I/C	Sub I/C	O/G
SHPPI M WP 6	1SYN869004R0047	6 way	8	6	12
SHPPI M WP 8	1SYN869004R0048	8 way	8	6	18
SHPPI M WP 12	1SYN869004R0049	12 way	8	6	30
SHPPI M WP 16	1SYN869004R0050	16 way	8	6	42



Distribution boards

Classic series – dimensional drawing

IP 30 SHPPI WD range

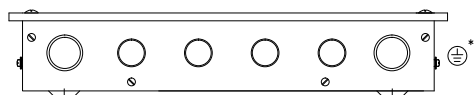
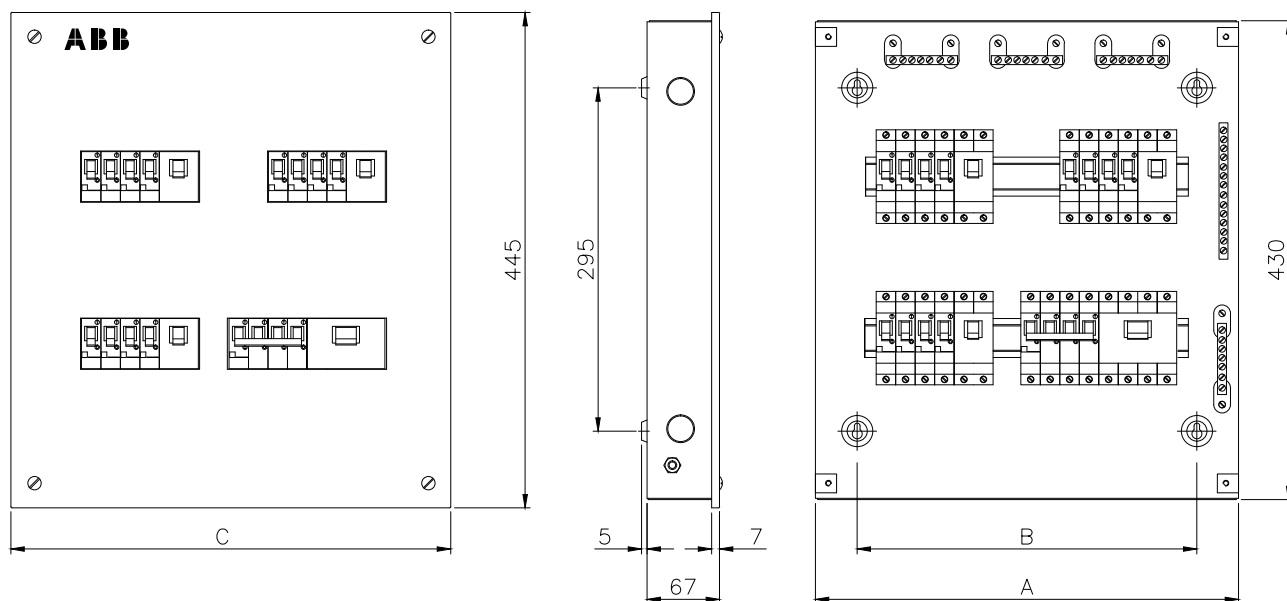

Code	Way	A	B	C	Top & Bottom Ø 26,K' out	Top & Bottom Ø 32,K' out	Both Sides Ø 26, K' out
SHPPI WD6	4+2	380	305	395	4 Nos	2 Nos	2 Nos
SHPPI WD8	6+2	470	395	485	5 Nos	2 Nos	2 Nos
SHPPI WD12	10+2	615	540	630	8 Nos	2 Nos	2 Nos
SHPPI WD16	14+2	760	685	775	10 Nos	2 Nos	2 Nos

IP 43 SHPPI M range

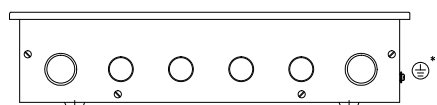
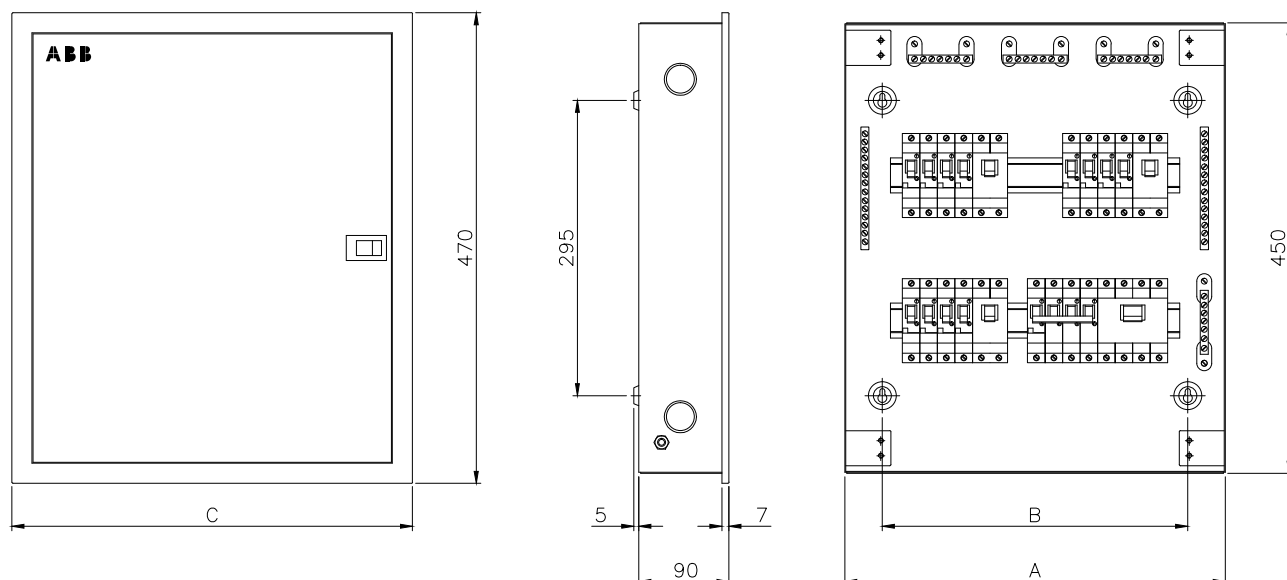

Code	Way	A	B	C	Top & Bottom Ø 26,K' out	Top & Bottom Ø 32,K' out	Both Sides Ø 26, K' out
SHPPI M06	4+2	380	305	400	4 Nos	2 Nos	2 Nos
SHPPI M08	6+2	470	395	490	5 Nos	2 Nos	2 Nos
SHPPI M10	8+2	545	470	565	7 Nos	2 Nos	2 Nos
SHPPI M12	10+2	615	540	635	8 Nos	2 Nos	2 Nos

All dimensions are in mm

Distribution boards

Classic series – dimensional drawing

IP 43 SHPPI M 16 range

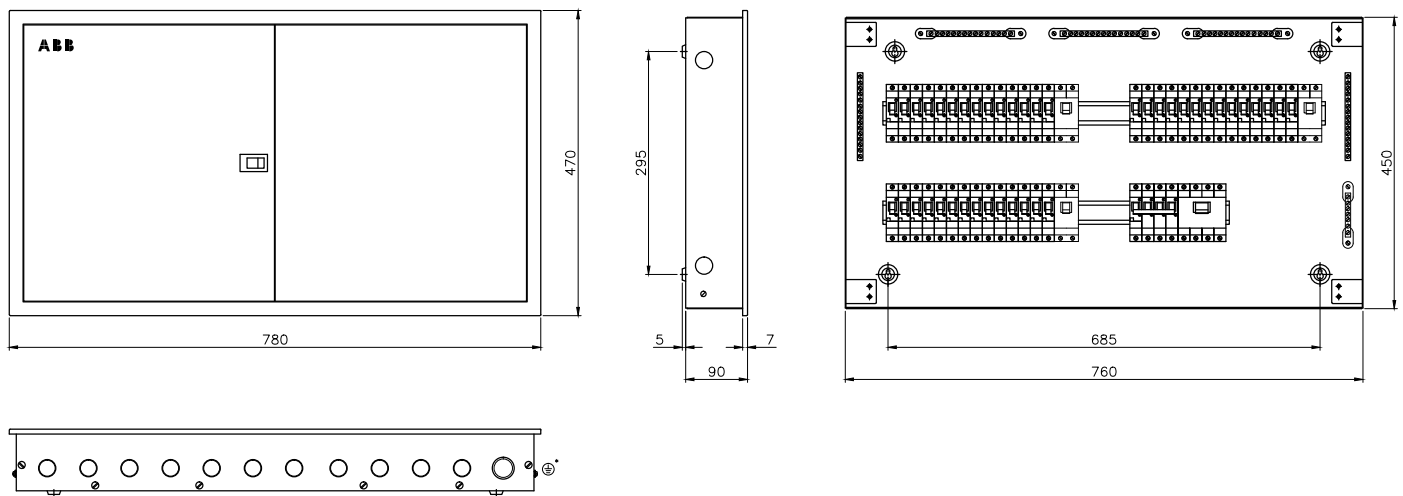

IP 43 SHPPI P range

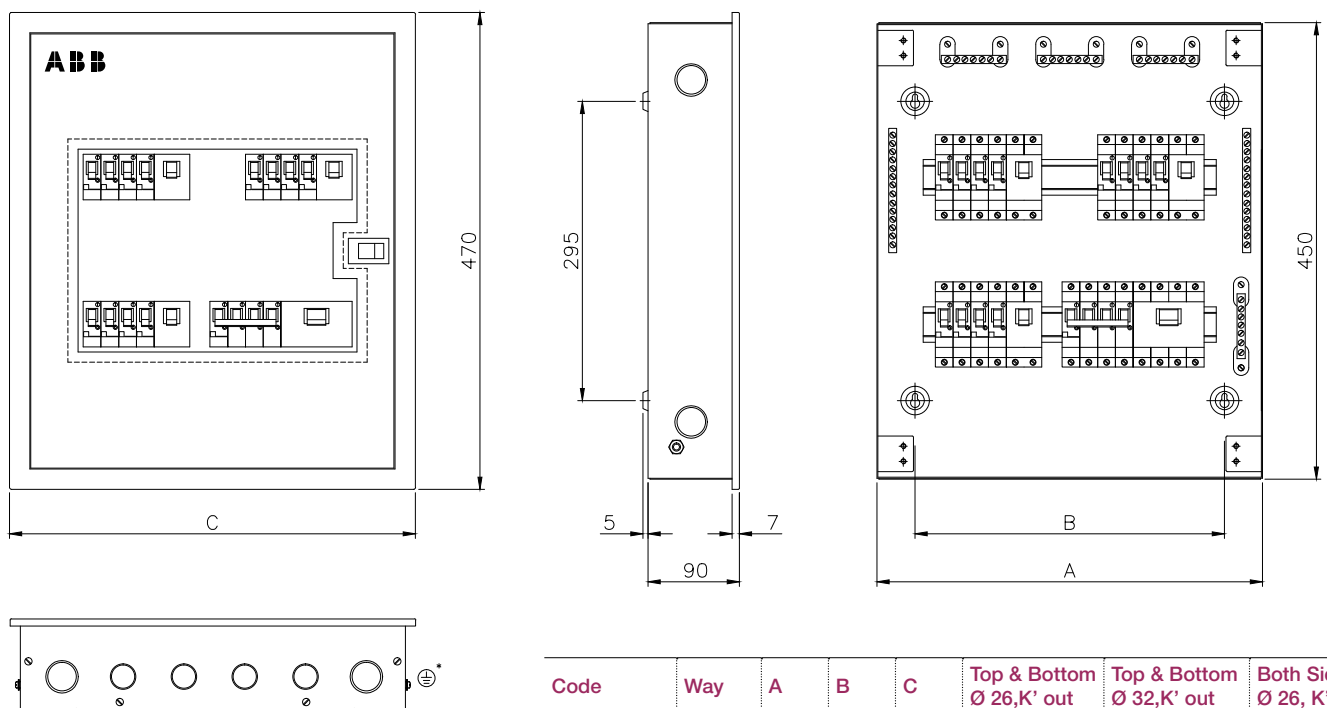

Code	Way	A	B	C	Top & Bottom Ø 26, K' out	Top & Bottom Ø 32, K' out	Both Sides Ø 26, K' out
SHPPI P06	4+2	380	305	400	4 Nos	2 Nos	2 Nos
SHPPI P08	6+2	470	395	490	5 Nos	2 Nos	2 Nos
SHPPI P10	8+2	545	470	565	7 Nos	2 Nos	2 Nos
SHPPI P12	10+2	615	540	635	8 Nos	2 Nos	2 Nos

All dimensions are in mm

Distribution boards

Classic series – dimensional drawing

IP 43 SHPPI P 16 range

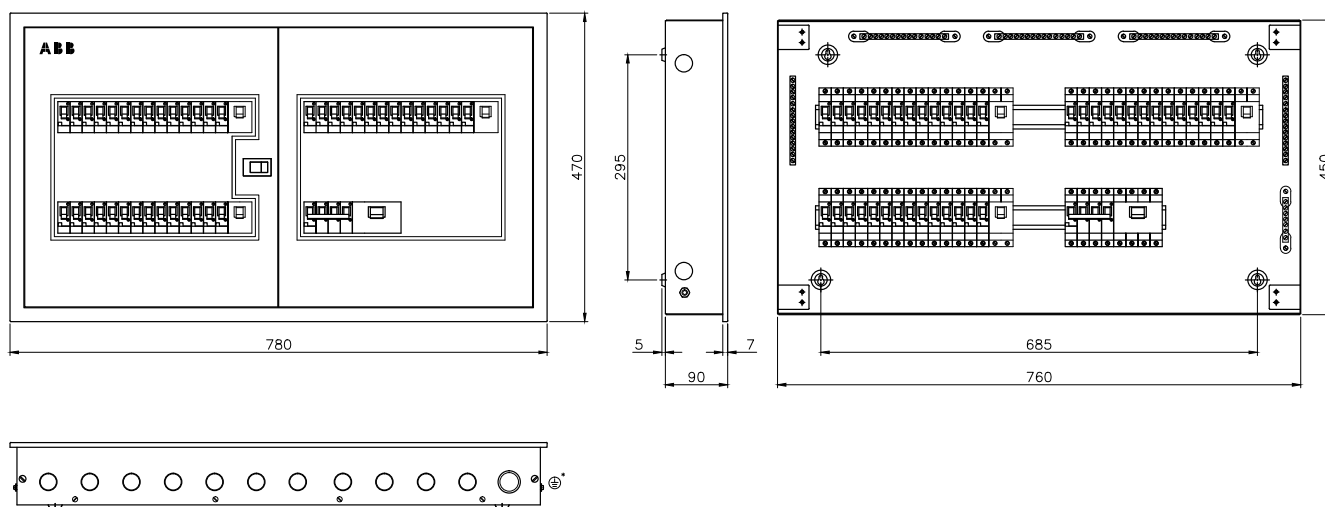

IP 54 SHPPI M WP range

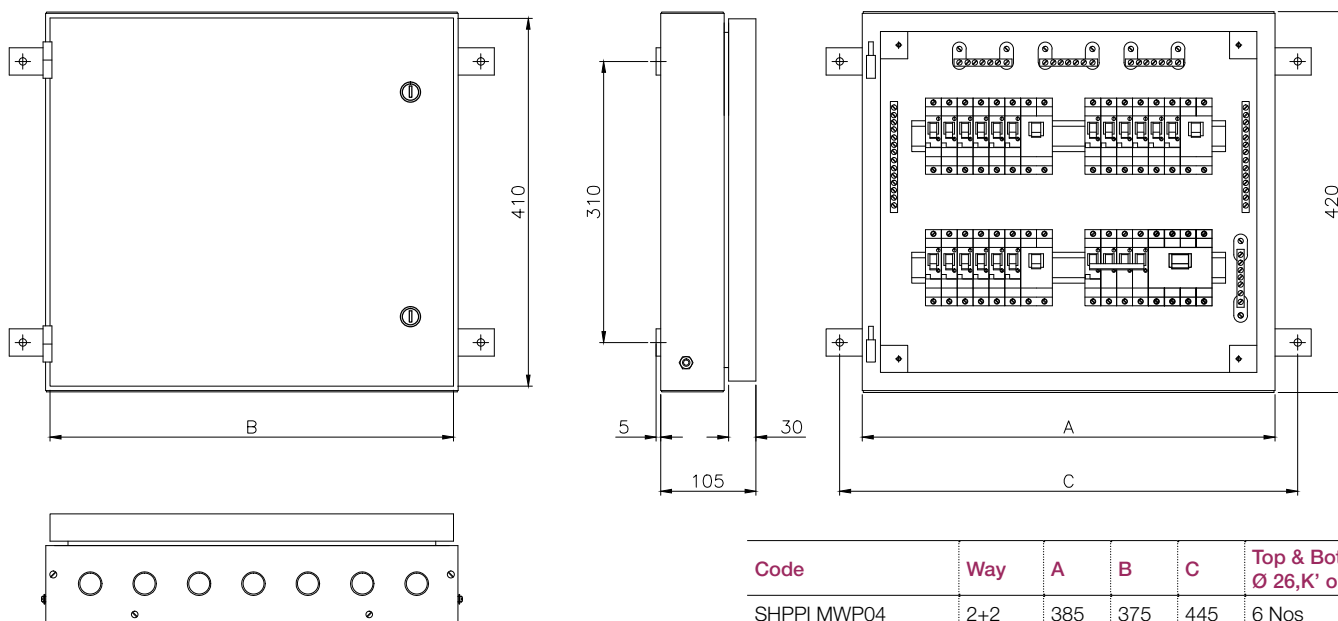

Code	Way	A	B	C	Top & Bottom Ø 26, K' out
SHPPI MWP04	2+2	385	375	445	6 Nos
SHPPI MWP06	4+2	420	410	480	6 Nos
SHPPI MWP08	6+2	465	455	525	7 Nos
SHPPI MWP10	8+2	520	510	580	8 Nos
SHPPI MWP12	10+2	595	585	655	9 Nos
SHPPI MWP14	12+2	665	655	725	10 Nos

All dimensions are in mm

Distribution boards

Classic series – dimensional drawing

IP 54 SHPPI M WP 16 range

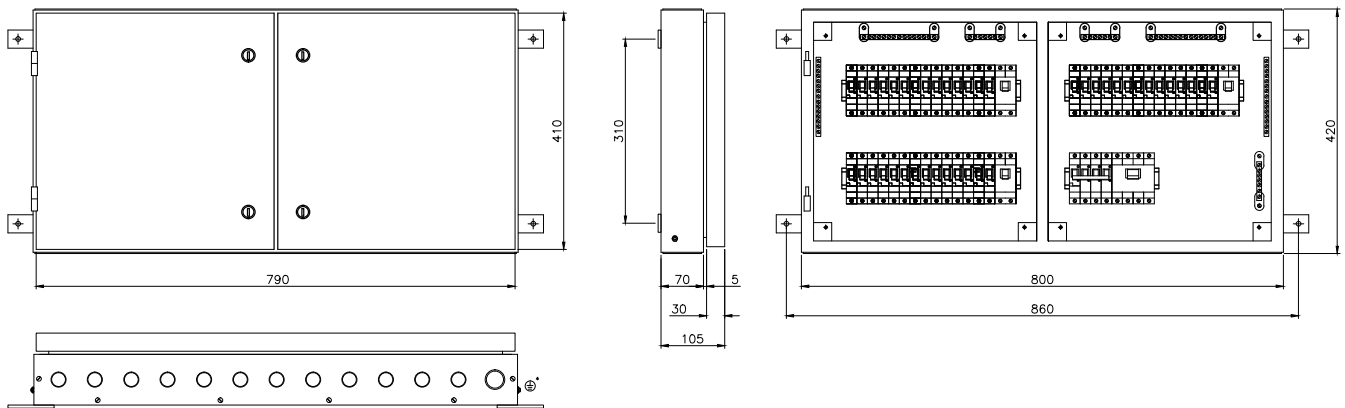

All dimensions are in mm

Distribution boards

Classic series – per phase isolation DB – SVDB



Vertical per-phase Isolation Distribution Board in 4-tier structure with provision for 8 pole (MCB / Isolator / RCD) incomer and 2 pole (MCB / Isolator / RCD) as sub-incomer with single phase outgoing.

These distribution boards come with separate neutral link for each phase, earthing link, tinned electrolytic copper busbar and wire sets for cable management.

Top and bottom removable gland plates with knockouts. Mounting of these boards can be flush or surface.

Available in IP 43 (with metal door)

IP 43 (metal door with acrylic)

IP 43 with metal door

Product description	Product code	No of ways	No of modules		
			I/C	Sub I/C	O/G
SVDB M 6	1SYN869028R0001	6 way	8	6	18
SVDB M 8	1SYN869029R0001	8 way	8	6	24
SVDB M 12	1SYN869030R0001	12 way	8	6	36

IP 43 metal door with acrylic

Product description	Product code	No of Ways	No of modules		
			I/C	Sub I/C	O/G
SVDB P 6	1SYN869004R0030	6 way	8	6	18
SVDB P 8	1SYN869004R0031	8 way	8	6	24
SVDB P 12	1SYN869004R0032	12 way	8	6	36



Distribution boards

Classic series – dimensional drawing

IP 43 SVDB M range

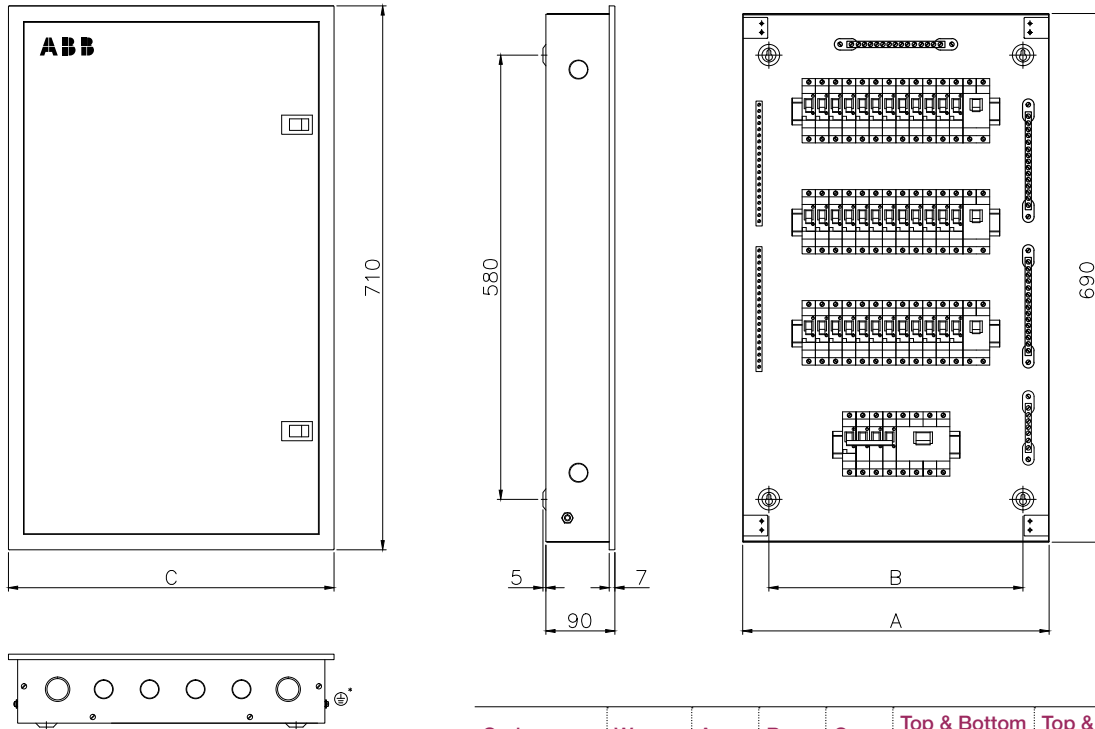

Code	Way	A	B	C	Top & Bottom Ø 26, K' out	Top & Bottom Ø 32, K' out	Both Sides Ø 26, K' out
SVDB M6	6+2	325	250	345	3 Nos	2 Nos	2 Nos
SVDB M8	8+2	360	285	340	3 Nos	2 Nos	2 Nos
SVDB M12	12+2	435	360	455	5 Nos	2 Nos	2 Nos

IP 43 SVDB P range

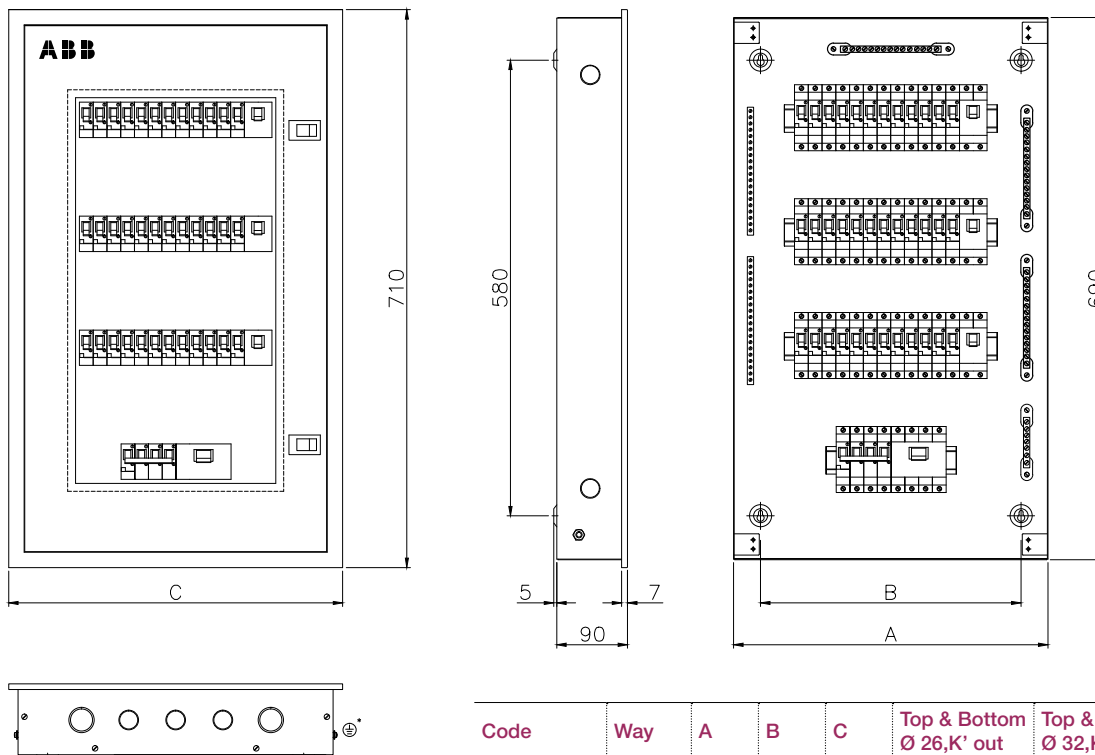

Code	Way	A	B	C	Top & Bottom Ø 26, K' out	Top & Bottom Ø 32, K' out	Both Sides Ø 26, K' out
SVDB P6	6+2	325	250	345	3 Nos	2 Nos	2 Nos
SVDB P8	8+2	360	285	380	3 Nos	2 Nos	2 Nos
SVDB P12	12+2	435	360	455	5 Nos	2 Nos	2 Nos

All dimensions are in mm

Distribution boards

Classic series – vertical DB – SVTDB – MCB I/C



Vertical three phase distribution board with provision for 8 pole (MCB / Isolator / RCD) incoming with three phase and single phase (TP/SP) outgoing

These distribution boards come with complete insulated busbar (tinned electrolytic copper) arrangement, neutral bar and earth bars.

Top and bottom removable gland plates with knockouts. Mounting of these boards can be flush or surface.

Available in IP 30 (without door)

IP 43 & IP 54 (with metal door)

IP 43 (metal door with acrylic)



IP 30

Product description	Product code	No of ways	No of modules	
			I/C	O/G
SVTDB WD 4	1SYN869035R0001	4 way	8	12
SVTDB WD 6	1SYN869036R0001	6 way	8	18
SVTDB WD 8	1SYN869037R0001	8 way	8	24
SVTDB WD 12	1SYN869038R0001	12 way	8	36

IP 43 with metal door

Product description	Product code	No of ways	No of modules	
			I/C	O/G
SVTDB M 4	1SYN869031R0001	4 way	8	12
SVTDB M 6	1SYN869032R0001	6 way	8	18
SVTDB M 8	1SYN869033R0001	8 way	8	24
SVTDB M 12	1SYN869034R0001	12 way	8	36

IP 43 metal door with acrylic

Product description	Product code	No of ways	No of modules	
			I/C	O/G
SVTDB P 4	1SYN869039R0001	4 way	8	12
SVTDB P 6	1SYN869040R0001	6 way	8	18
SVTDB P 8	1SYN869041R0001	8 way	8	24
SVTDB P 12	1SYN869042R0001	12 way	8	36

IP 54

Product description	Product code	No of ways	No of modules	
			I/C	O/G
SVTDB M WP 4	1SYN869004R0041	4 way	8	12
SVTDB M WP 6	1SYN869004R0015	6 way	8	18
SVTDB M WP 8	1SYN869004R0043	8 way	8	24
SVTDB M WP 12	1SYN869004R0044	12 way	8	36

Distribution boards

Classic series – dimensional drawing

IP 30 SVTDB WD range

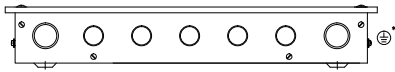
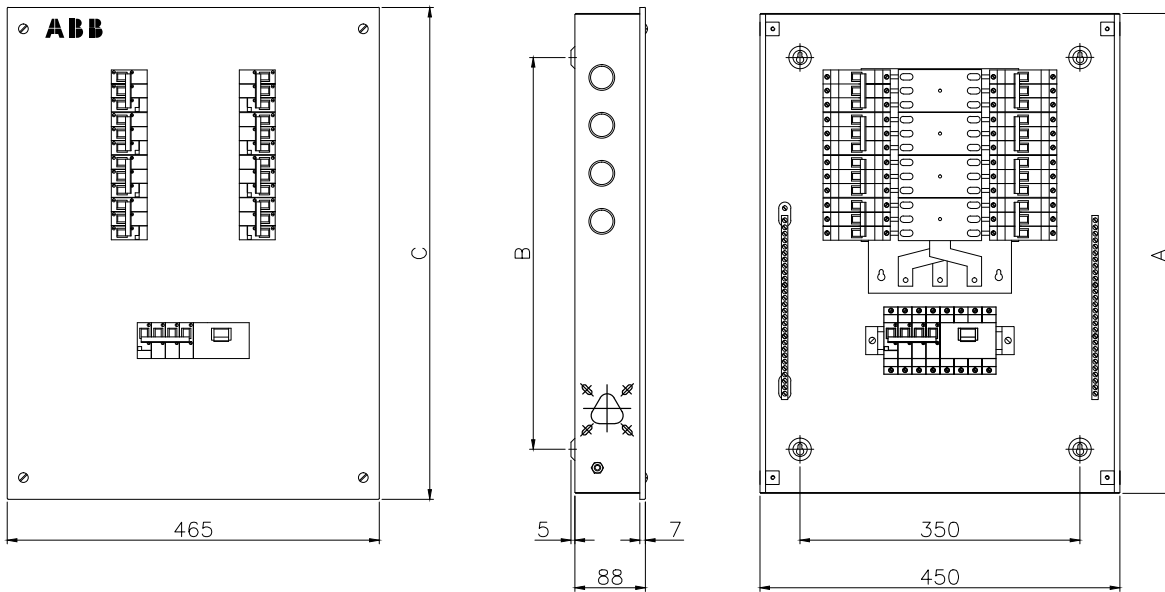

Code	Way	A	B	C	Top & Bottom Ø 26,K' out	Top & Bottom Ø 32,K' out	Both Sides Ø 26, K' out	I/C
SVTDB WD4	4	500	400	515	5 Nos	2 Nos	4 Nos	
SVTDB WD6	6	554	454	569	5 Nos	2 Nos	6 Nos	8 Pole MCB
SVTDB WD8	8	608	508	623	5 Nos	2 Nos	8 Nos	
SVTDB WD12	12	716	616	731	5 Nos	2 Nos	12 Nos	

IP 43 SVTDB M range

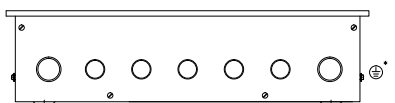
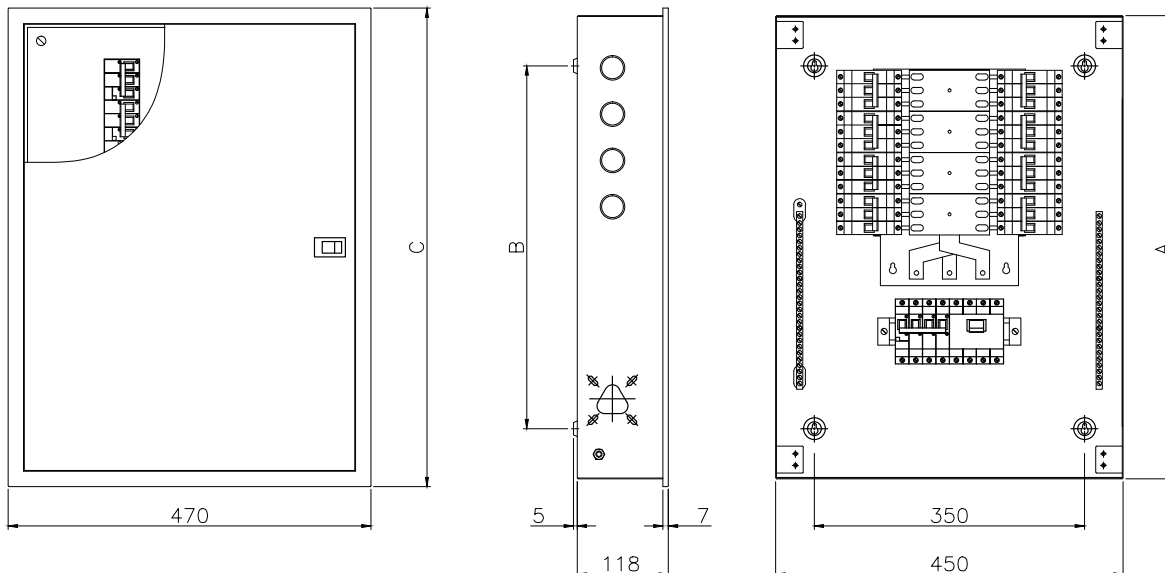

Code	Way	A	B	C	Top & Bottom Ø 26,K' out	Top & Bottom Ø 32,K' out	Both Sides Ø 26, K' out	I/C
SVTDB M4	4	500	400	520	5 Nos	2 Nos	4 Nos	
SVTDB M6	6	554	454	574	5 Nos	2 Nos	6 Nos	8 Pole MCB
SVTDB M8	8	608	508	628	5 Nos	2 Nos	8 Nos	
SVTDB M12	12	716	616	738	5 Nos	2 Nos	12 Nos	

All dimensions are in mm

Distribution boards

Classic series – dimensional drawing

IP 43 SVTDB P range

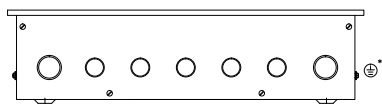
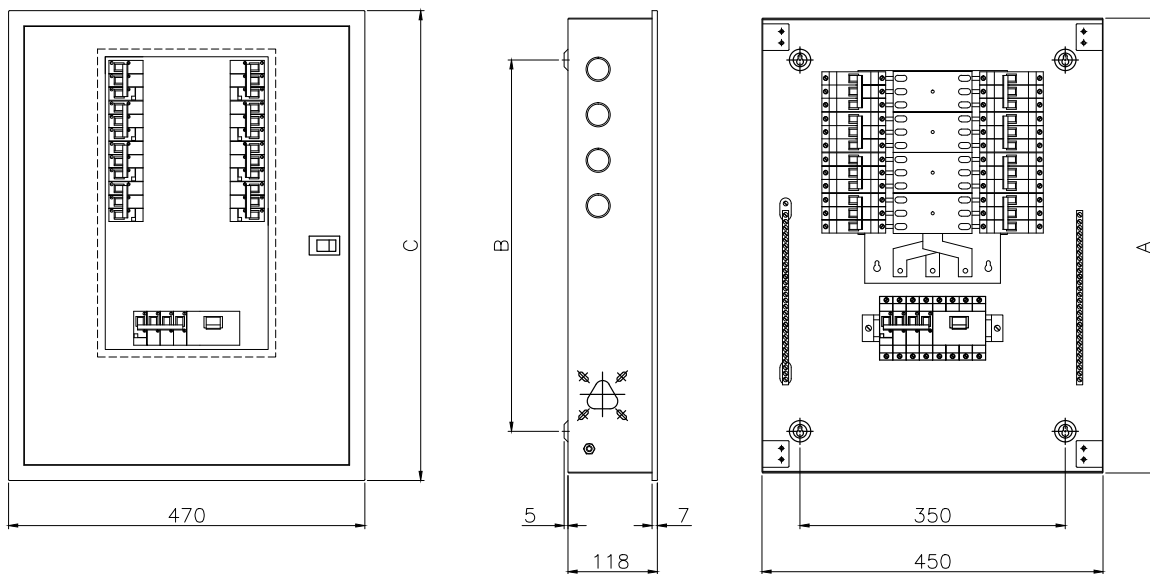

Code	Way	A	B	C	Top & Bottom Ø 26, K' out	Top & Bottom Ø 32, K' out	Both Sides Ø 26, K' out	I/C
SVTDB P4	4	500	400	520	5 Nos	2 Nos	4 Nos	8 Pole MCB
SVTDB P6	6	554	454	574	5 Nos	2 Nos	6 Nos	
SVTDB P8	8	608	508	628	5 Nos	2 Nos	8 Nos	
SVTDB P12	12	716	616	738	5 Nos	2 Nos	12 Nos	

IP 54 SVTDB M WP range

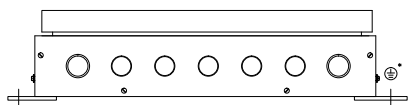
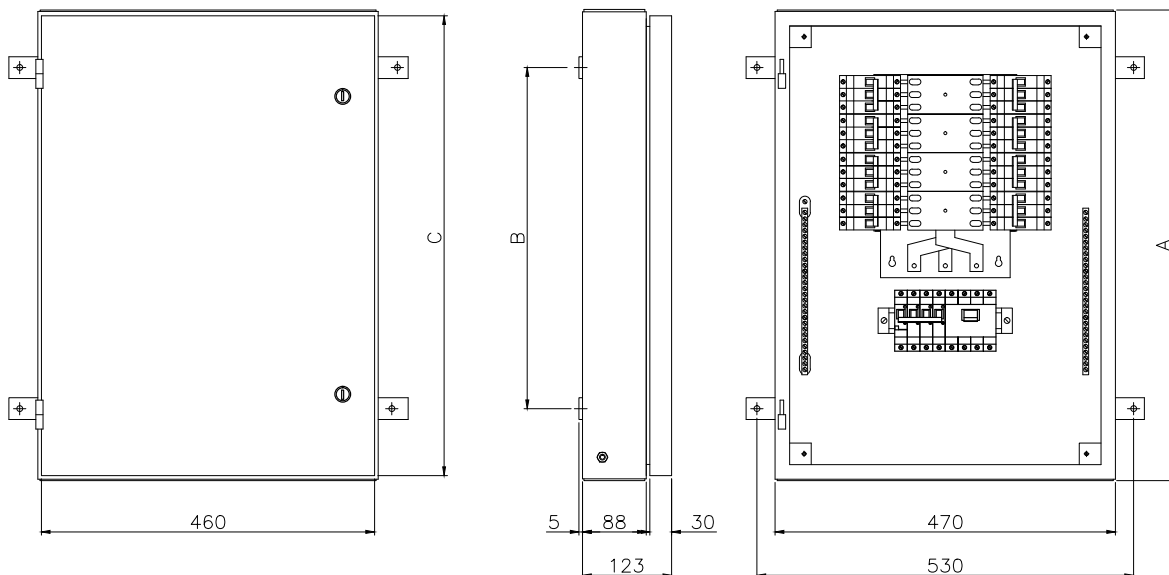

Code	Way	A	B	C	Top & Bottom Ø 26, K' out	Top & Bottom Ø 32, K' out	I/C
SVTDB MWP4	4	540	440	530	5 Nos	2 Nos	8 Pole MCB
SVTDB MWP6	6	594	494	584	5 Nos	2 Nos	
SVTDB MWP8	8	648	548	638	5 Nos	2 Nos	
SVTDB MWP12	12	756	656	746	5 Nos	2 Nos	

All dimensions are in mm

Distribution boards

Classic series – vertical DB – SVTDB T1



Vertical three phase distribution board with provision for 4 pole MCCB (T-max/T1) up to 160A as incomer with three phase and single phase (TP/SP) MCB outgoing.

These distribution boards come with complete insulated busbar (tinned electrolytic copper) arrangement, neutral bar and earth bars.

Top and bottom removable gland plates with knockouts. Mounting of these boards can be flush or surface.

Available in IP 30 (without door)

IP 43 (with metal door)

IP 54 (with metal door)

IP 30

Product description	Product code	No of ways	No of modules	
			I/C	O/G
SVTDB WD 4 T1	1SYN869070R0001	4 way	T-max	12
SVTDB WD 6 T1	1SYN869071R0001	6 way	T-max	18
SVTDB WD 8 T1	1SYN869072R0001	8 way	T-max	24
SVTDB WD 12 T1	1SYN869073R0001	12 way	T-max	36

IP43 with metal door

Product description	Product code	No of ways	No of modules	
			I/C	O/G
SVTDB M 4 T1	1SYN869066R0001	4 way	T-max	12
SVTDB M 6 T1	1SYN869067R0001	6 way	T-max	18
SVTDB M 8 T1	1SYN869068R0001	8 way	T-max	24
SVTDB M 12 T1	1SYN869069R0001	12 way	T-max	36

IP54

Product description	Product code	No of ways	No of modules	
			I/C	O/G
SVTDB M WP 4T1	1SYN869004R0060	4 way	T-max	12
SVTDB M WP 6T1	1SYN869004R0061	6 way	T-max	18
SVTDB M WP 8T1	1SYN869004R0062	8 way	T-max	24
SVTDB M WP 12T1	1SYN869004R0063	12 way	T-max	36

Distribution boards

Classic series – dimensional drawing

IP 30 SVTDB WD T1 range

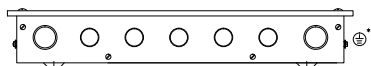
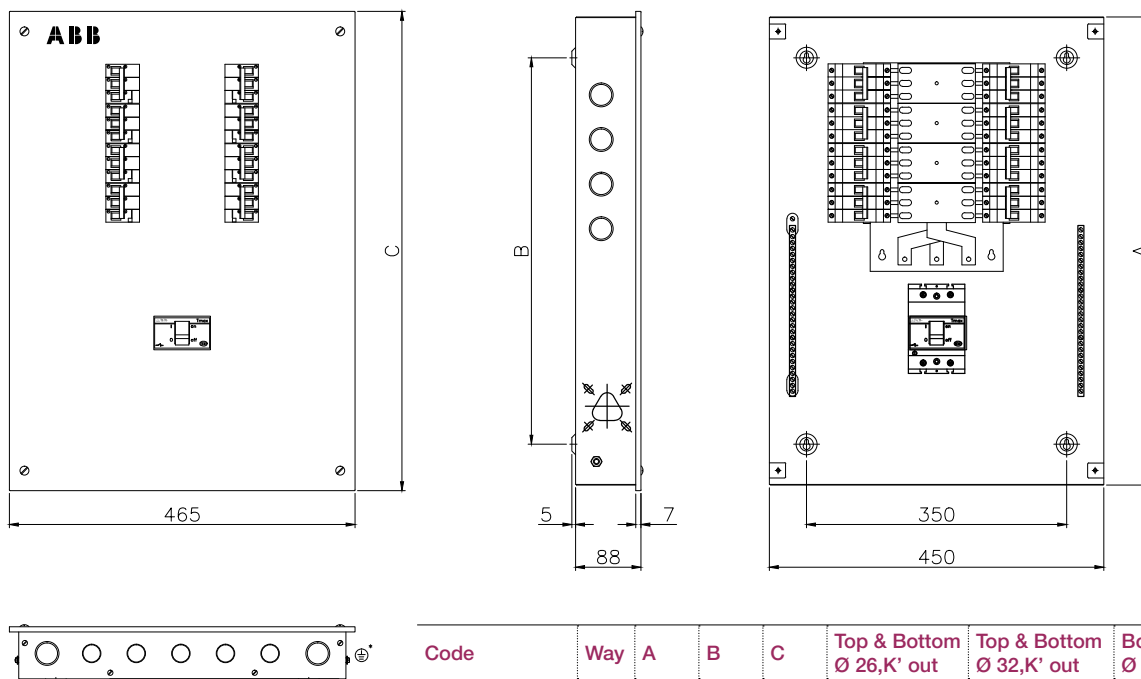

Code	Way	A	B	C	Top & Bottom Ø 26, K' out	Top & Bottom Ø 32, K' out	Both Sides Ø 26, K' out	I/C
SVTDB T1 WD4	4	555	455	570	5 Nos	2 Nos	4 Nos	T1 MCCB
SVTDB T1 WD6	6	609	509	624	5 Nos	2 Nos	6 Nos	
SVTDB T1 WD8	8	663	563	678	5 Nos	2 Nos	8 Nos	
SVTDB T1 WD12	12	771	671	786	5 Nos	2 Nos	12 Nos	

IP 43 SVTDB M T1 range

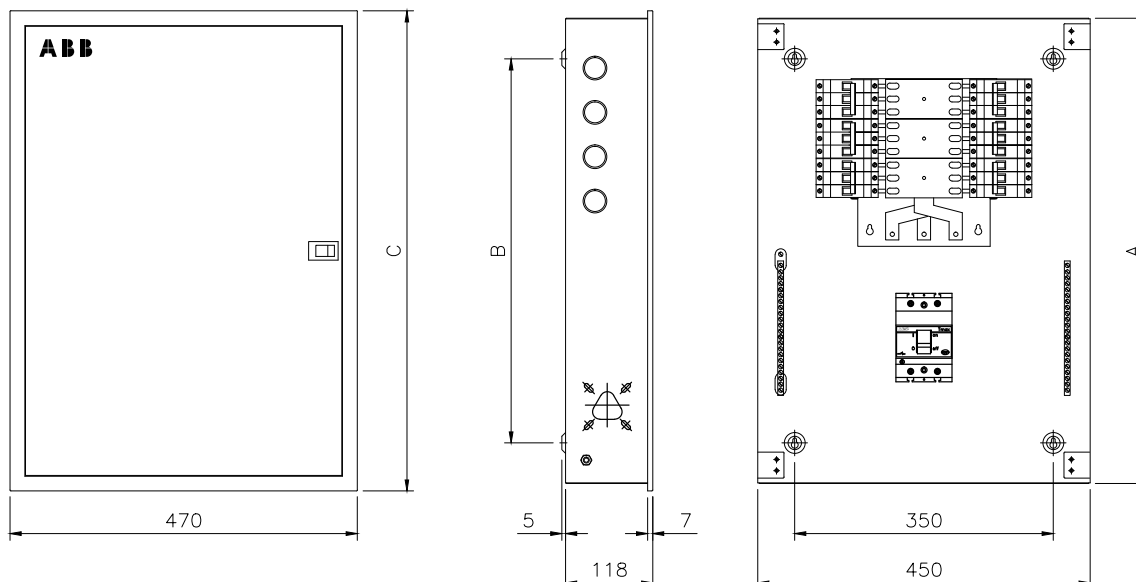

Code	Way	A	B	C	Top & Bottom Ø 26, K' out	Top & Bottom Ø 32, K' out	Both Sides Ø 26, K' out	I/C
SVTDB T1 M4	4	555	455	575	5 Nos	2 Nos	4 Nos	T1 MCCB
SVTDB T1 M6	6	609	509	629	5 Nos	2 Nos	6 Nos	
SVTDB T1 M8	8	663	663	683	5 Nos	2 Nos	8 Nos	
SVTDB T1 M12	12	771	771	791	5 Nos	2 Nos	12 Nos	

All dimensions are in mm

Distribution boards

Classic series – dimensional drawing

IP 54 SVTDB M WP T1 range

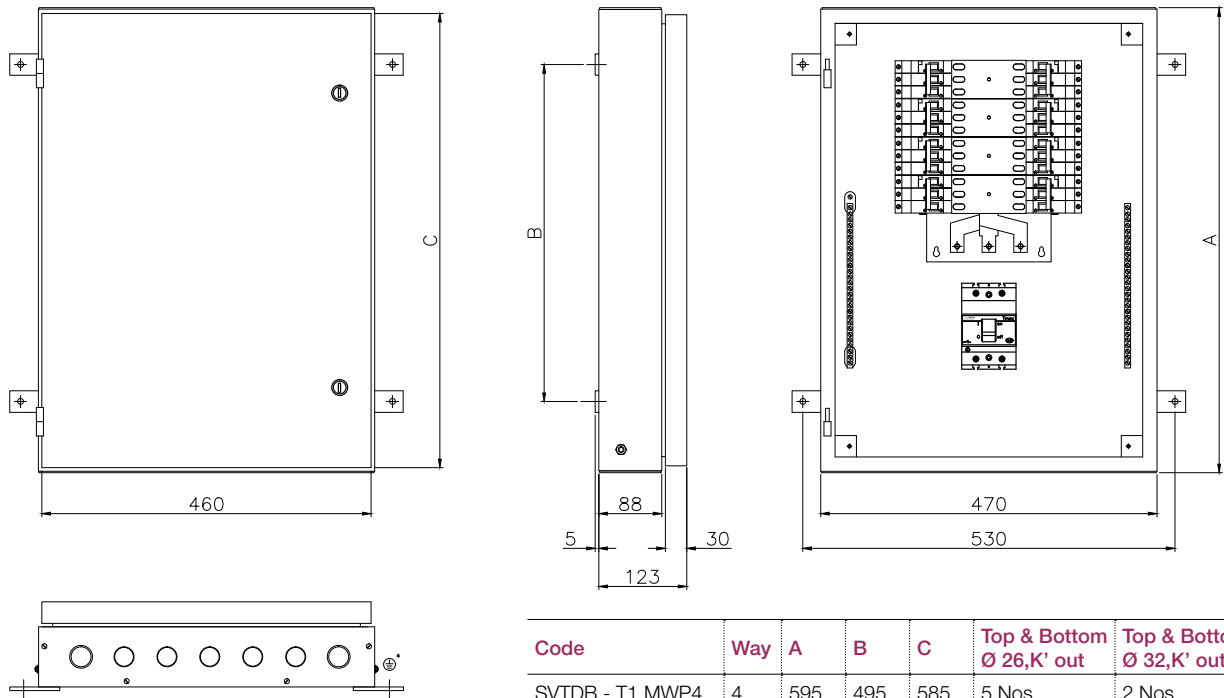

Code	Way	A	B	C	Top & Bottom Ø 26,K' out	Top & Bottom Ø 32,K' out	I/C
SVTDB - T1 MWP4	4	595	495	585	5 Nos	2 Nos	T1 MCCB
SVTDB - T1 MWP6	6	650	550	640	5 Nos	2 Nos	
SVTDB - T1 MWP8	8	700	600	690	5 Nos	2 Nos	
SBTDB - T1 MWP12	12	810	710	800	5 Nos	2 Nos	

All dimensions are in mm

Distribution boards

Classic series – vertical DB – SVTDB T3



Vertical three phase distribution board with provision for 4 pole MCCB (T-max/T3) up to 250A as incomer with three phase and single phase (TP/SP) MCB outgoing.

These distribution boards come with complete insulated busbar (tinned electrolytic copper) arrangement, neutral bar and earth bars.

Top and bottom removable gland plates with knockouts. Mounting of these boards can be flush or surface.

Available in IP 30 (without door)

IP 43 (with metal door)

IP 54 (with metal door)

IP 30

Product description	Product code	No of ways	No of modules	
			I/C	O/G
SVTDB WD 4 T3	1SYN869070R1004	4 way	T-max	12
SVTDB WD 6 T3	1SYN869070R0003	6 way	T-max	18
SVTDB WD 8 T3	1SYN869070R0004	8 way	T-max	24
SVTDB WD 12 T3	1SYN869070R0002	12 way	T-max	36

IP 43 with metal door

Product description	Product code	No of ways	No of modules	
			I/C	O/G
SVTDB M 4 T3	1SYN869081R0003	4 way	T-max	12
SVTDB M 6 T3	1SYN869081R0004	6 way	T-max	18
SVTDB M 8 T3	1SYN869081R0005	8 way	T-max	24
SVTDB M 12 T3	1SYN869081R0012	12 way	T-max	36

IP 54

Product description	Product code	No of ways	No of modules	
			I/C	O/G
SVTDB M WP 4 T3	1SYN869005R0060	4 way	T-max	12
SVTDB M WP 6 T3	1SYN869005R0061	6 way	T-max	18
SVTDB M WP 8 T3	1SYN869005R0062	8 way	T-max	24
SVTDB M WP 12 T3	1SYN869005R0063	12 way	T-max	36

Distribution boards

Classic series – dimensional drawing

IP 30 SVTDB WD T3 range

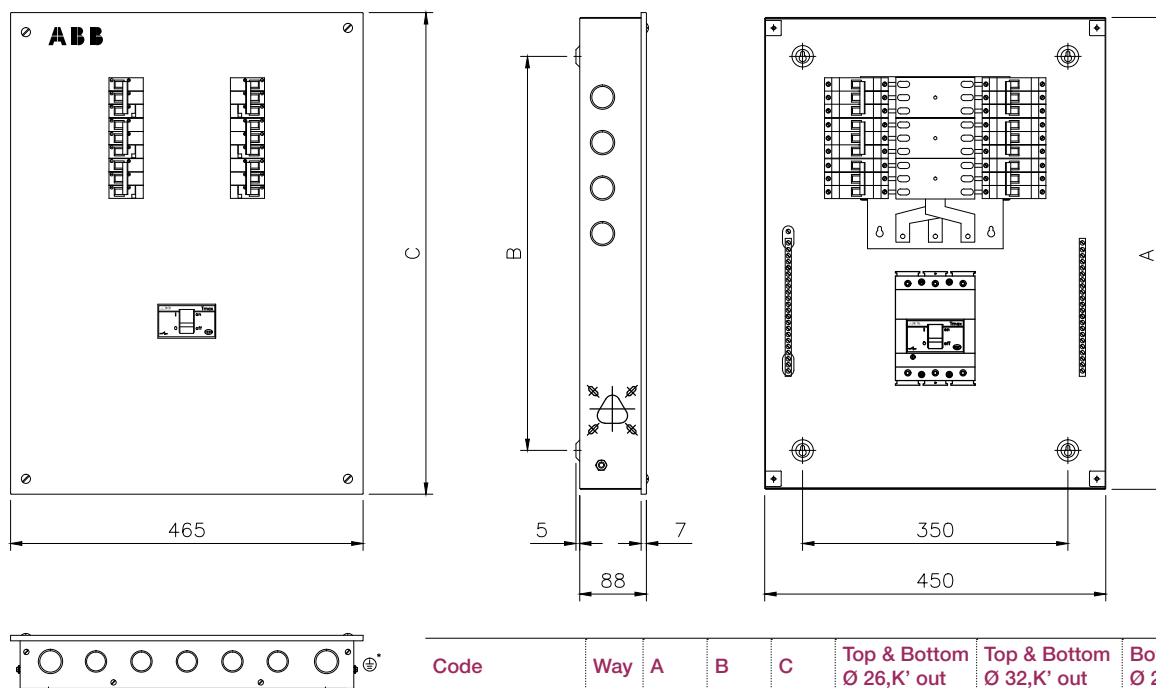

Code	Way	A	B	C	Top & Bottom Ø 26,K' out	Top & Bottom Ø 32,K' out	Both Sides Ø 26, K' out	I/C
SVTDB T3 WD4	4	640	540	655	5 Nos	2 Nos	4 Nos	T3 MCCB
SVTDB T3 WD6	6	694	594	709	5 Nos	2 Nos	4 Nos	
SVTDB T3 WD8	8	748	648	763	5 Nos	2 Nos	4 Nos	
SVTDB T3 WD12	12	856	756	871	5 Nos	2 Nos	4 Nos	

IP 43 SVTDB M T3 range

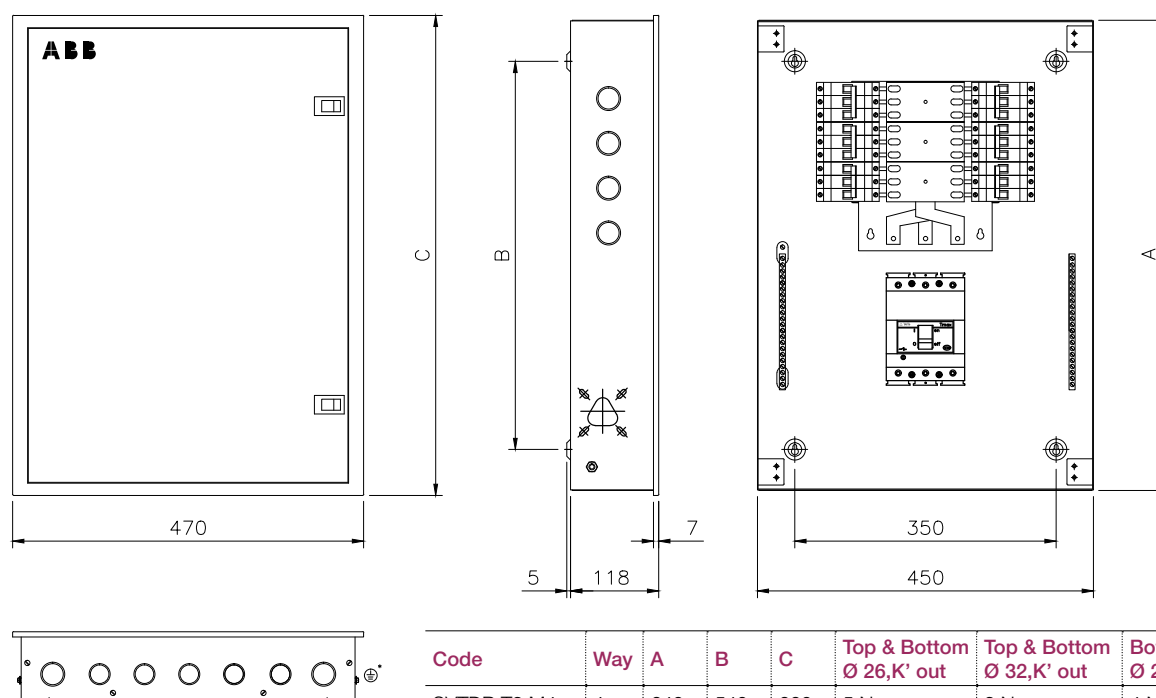

Code	Way	A	B	C	Top & Bottom Ø 26,K' out	Top & Bottom Ø 32,K' out	Both Sides Ø 26, K' out	I/C
SVTDB T3 M4	4	640	540	660	5 Nos	2 Nos	4 Nos	T3 MCCB
SVTDB T3 M6	6	694	594	714	5 Nos	2 Nos	6 Nos	
SVTDB T3 M8	8	748	648	768	5 Nos	2 Nos	8 Nos	
SVTDB T3 M12	12	856	756	876	5 Nos	2 Nos	12 Nos	

All dimensions are in mm

Distribution boards

Classic series – dimensional drawing

IP 54 SVTDB M WP T3 range

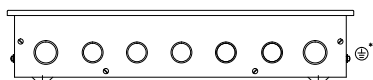
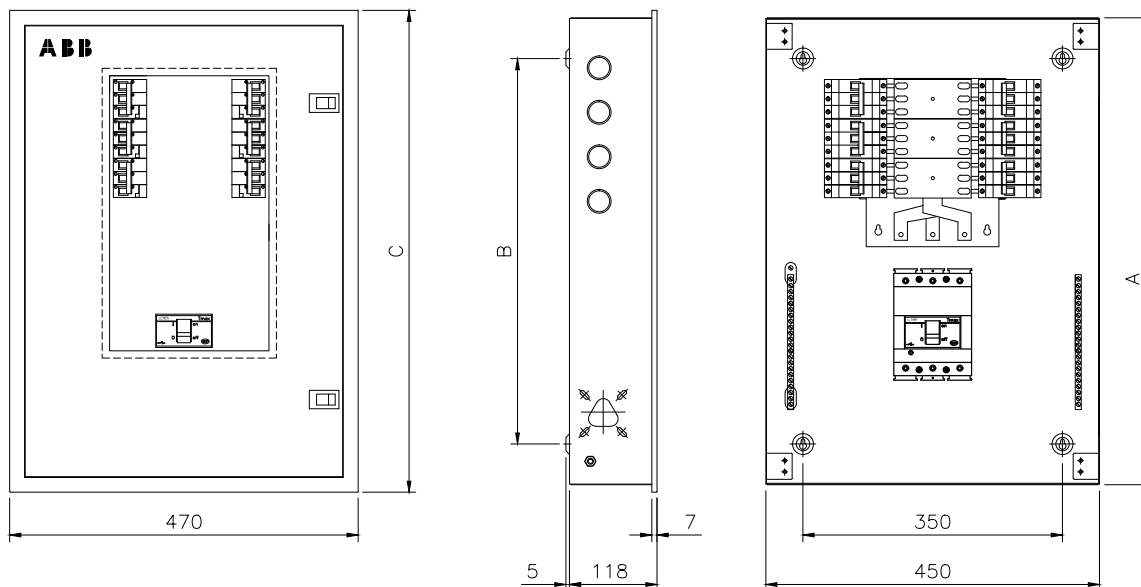

Code	Way	A	B	C	Top & Bottom Ø 26, K' out	Top & Bottom Ø 32, K' out	Both Sides Ø 26, K' out	I/C
SVTDB T3 P4	4	640	540	660	5 Nos	2 Nos	4 Nos	T2 MCCB
SVTDB T3 P6	6	694	594	714	5 Nos	2 Nos	6 Nos	
SVTDB T3 P8	8	748	648	768	5 Nos	2 Nos	8 Nos	
SVTDB T3 P12	12	856	756	876	5 Nos	2 Nos	12 Nos	

All dimensions are in mm

Distribution boards

Classic series – flexi tier DB – SVFL



Total flexibility as per site needs – configuration as per your choice of incomer and outgoing. Supply busbars need to be selected.

These distribution boards come with neutral link, earthing link.

Top and bottom, removable gland plates with knockouts. Mounting of these boards can be flush or surface.

Available in IP 43 (with metal door)

IP 43 (metal door with acrylic)

IP 43 with metal door

Product description	product Code	No of ways	No of rows	No of modules
SVFL M 132	1SYN869004R0051	2 row of 13mod	2	26
SVFL M 133	1SYN869103R0001	3 row of 13mod	3	39
SVFL M 134	1SYN869103R0002	4 row of 13mod	4	52
SVFL M 142	1SYN869004R0052	2 row of 14mod	2	28
SVFL M 143	1SYN869004R0053	3 row of 14mod	3	42
SVFL M 144	1SYN869103R0012	4 row of 14mod	4	56

IP43 metal door with acrylic

Product description	Product code	No of ways	No of rows	No of modules
SVFL P 132	1SYN869004R0054	2 row of 13mod	2	26
SVFL P 133	1SYN869105R0001	3 row of 13mod	3	39
SVFL P 134	1SYN869105R0002	4 row of 13mod	4	52
SVFL P 142	1SYN869004R0055	2 row of 14mod	2	28
SVFL P 143	1SYN869004R0056	3 row of 14mod	3	42
SVFL P 144	1SYN869004R0057	4 row of 14mod	4	56

Distribution boards

Classic series – dimensional drawing

IP 43 SVFL M range

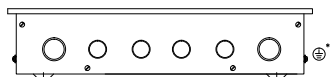
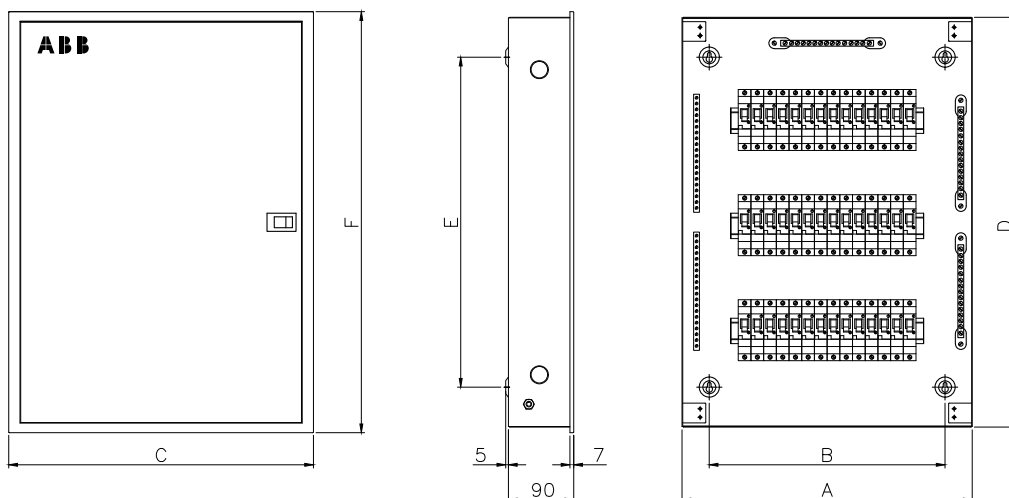

Code	A	B	C	D	E	F	Top & Bottom Ø 26,K' out	Top & Bottom Ø 32,K' out	Both Sides Ø 26, K' out
SVFL M132	400	325	420	400	290	420	4 Nos	2 Nos	2 Nos
SVFL M133	400	325	420	565	455	585	4 Nos	2 Nos	2 Nos
SVFL M134	400	325	420	690	580	710	4 Nos	2 Nos	2 Nos
SVFL M142	420	345	440	400	290	420	4 Nos	2 Nos	2 Nos
SVFL M143	420	345	440	565	455	585	4 Nos	2 Nos	2 Nos
SVFL M144	420	345	440	690	580	710	4 Nos	2 Nos	2 Nos

IP 43 SVFL P range

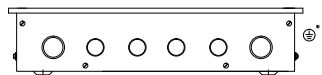
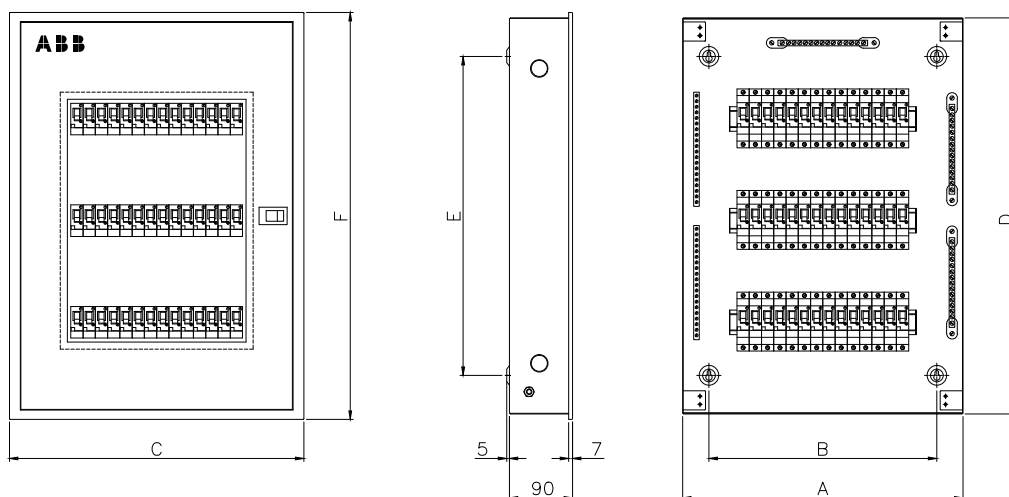

Code	A	B	C	D	E	F	Top & Bottom Ø 26,K' out	Top & Bottom Ø 32,K' out	Both Sides Ø 26, K' out
SVFL P132	400	325	420	400	290	420	4 Nos	2 Nos	2 Nos
SVFL P133	400	325	420	565	455	585	4 Nos	2 Nos	2 Nos
SVFL P134	400	325	420	690	580	710	4 Nos	2 Nos	2 Nos
SVFL P142	420	345	440	400	290	420	4 Nos	2 Nos	2 Nos
SVFL P143	420	345	440	565	455	585	4 Nos	2 Nos	2 Nos
SVFL P144	420	345	440	690	580	710	4 Nos	2 Nos	2 Nos

All dimensions are in mm

Distribution boards

Classic series – 7 segment MCB I/C DB – S7SEG



Seven segment distribution board with phase segregation and separation between incoming and outgoing with provision for 8 pole incomer (MCB / Isolator /RCD) and 4 pole as sub-incomers (MCB /Isolator /RCD) with single phase outgoing.

These distribution boards come with neutral bar, earthing link and wire sets for cable management for each compartment.

Top and bottom, removable gland plates with knockouts. Mounting of these boards can be flush or surface.

Available in IP 30 (without door)

IP 43 (with metal door)



IP 30

Product description	Product code	No of ways	No of modules		
			I/C	Sub I/C	O/G
S7SEG WD 4	1SYN869062R0001	4 way	8	12	12
S7SEG WD 6	1SYN869063R0001	6 way	8	12	18
S7SEG WD 8	1SYN869064R0001	8 way	8	12	24
S7SEG WD 12	1SYN869065R0001	12 way	8	12	36

IP 43 with metal door

Product description	Product code	No of ways	No of modules		
			I/C	Sub I/C	O/G
S7SEG M 4	1SYN869058R0001	4 way	8	12	12
S7SEG M 6	1SYN869059R0001	6 way	8	12	18
S7SEG M 8	1SYN869060R0001	8 way	8	12	24
S7SEG M 12	1SYN869061R0001	12 way	8	12	36

Distribution boards

Classic series – dimensional drawing

IP 30 S7SEG WD range

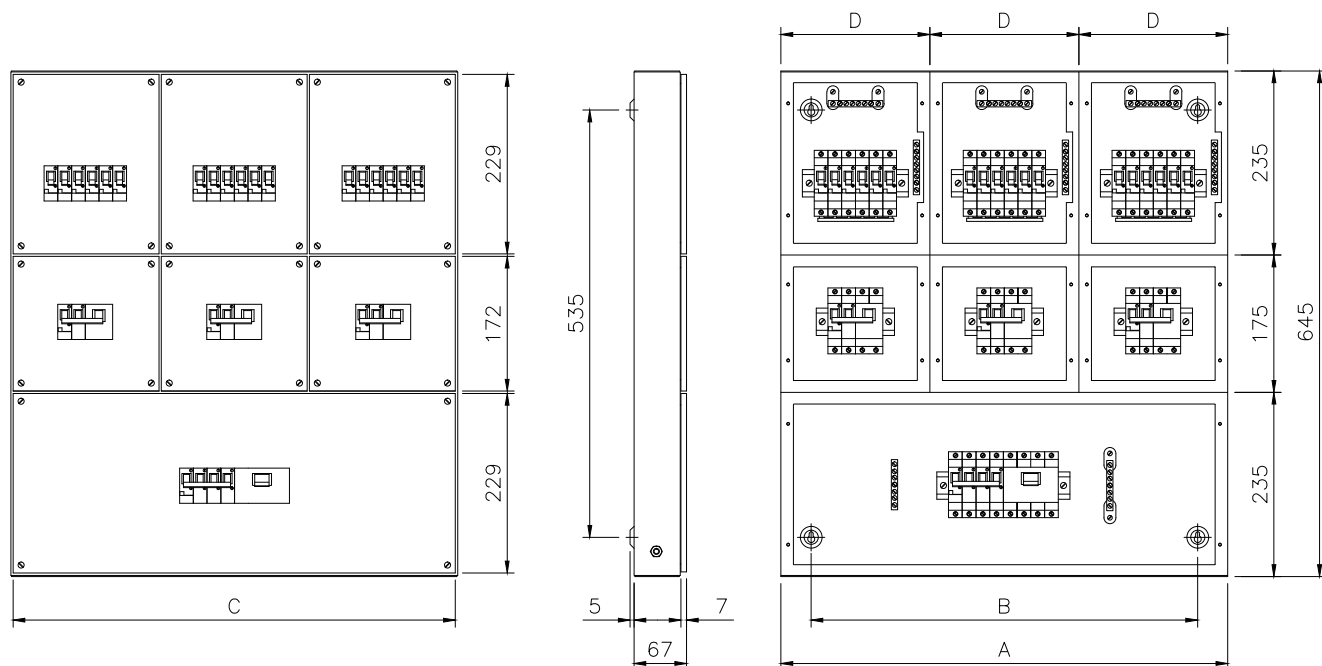

Code	Way	A	B	C	D	Top & Bottom Ø 26,K' out	Top & Bottom Ø 32,K' out
S7SEG WD4	4	490	415	485	163	07 Nos	2 Nos
S7SEG WD6	6	595	520	590	198	08 Nos	2 Nos
S7SEG WD8	8	700	625	695	233	10 Nos	2 Nos
S7SEG WD12	12	910	835	905	303	14 Nos	2 Nos

IP 30 S7SEG M range

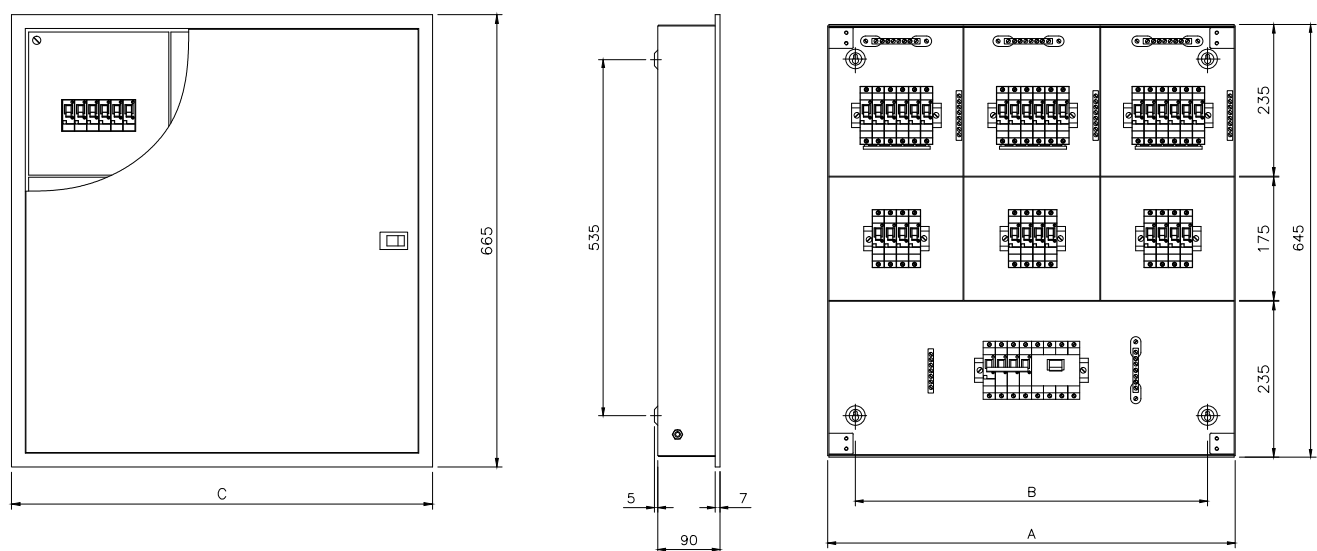

Code	Way	A	B	C	Top & Bottom Ø 26,K' out	Top & Bottom Ø 32,K' out
S7SEG M04	4	430	355	450	4 Nos	2 Nos
S7SEG M06	6	535	460	555	6 Nos	2 Nos

All dimensions are in mm

Distribution boards

Classic series – dimensional drawing

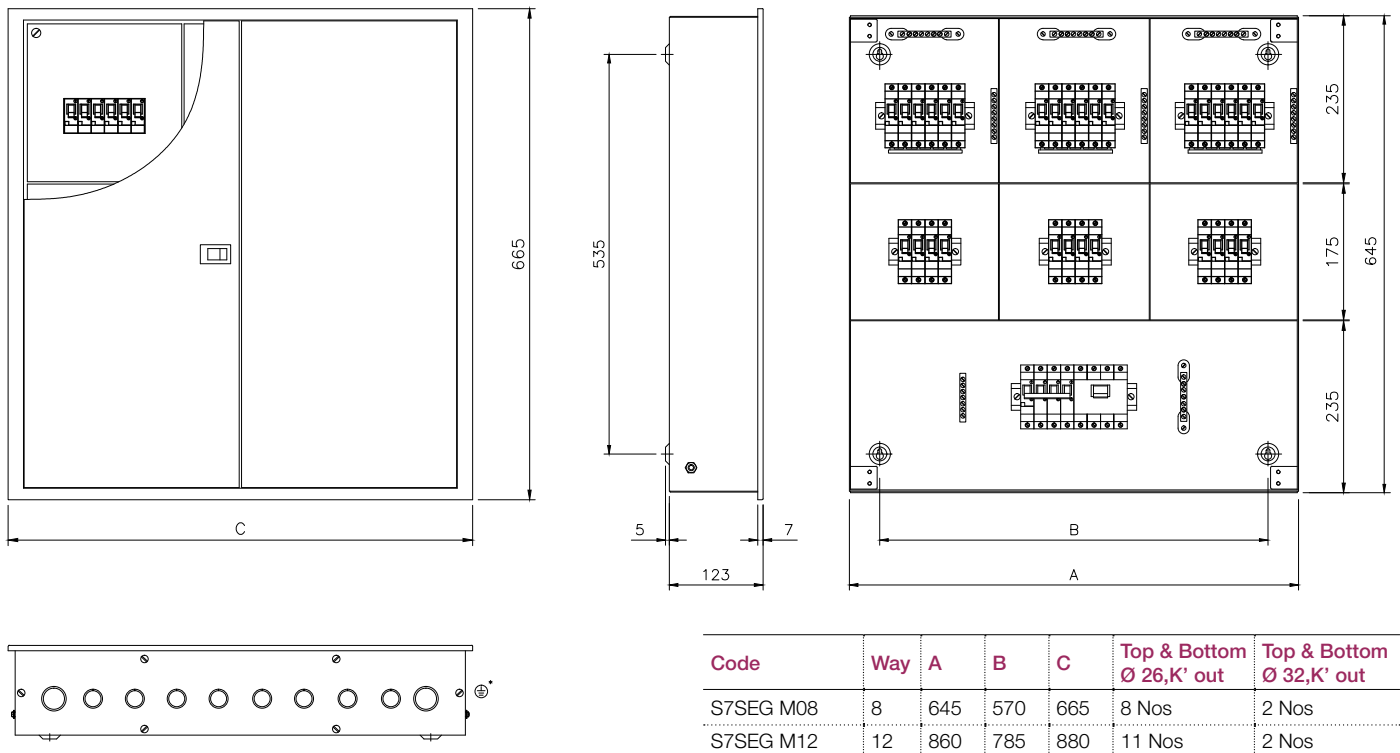

All dimensions are in mm

Distribution boards

Classic series – 7 segment MCCB I/C DB – S7SEG T1



Seven segment distribution board with phase segregation and separation between incoming and outgoing with provision for 4 pole MCCB (T-max/T1) up to 160A as incomer and 4 pole as sub-incomers (MCB /Isolator /RCD) with single phase outgoing.

These distribution boards come with neutral bar, earthing link and wire sets for cable management for each compartment.

Top and bottom, removable gland plates with knockouts. Mounting of these boards can be flush or surface.

Available in IP 30 (without door)

IP 43 (with metal door)

IP 30

Product description	Product code	No of ways	No of modules		
			I/C	Sub I/C	O/G
S7SEG WD 4T1	1SYN869004R0033	4 way	T-max	12	12
S7SEG WD 6T1	1SYN869004R0034	6 way	T-max	12	18
S7SEG WD 8T1	1SYN869004R0035	8 way	T-max	12	24
S7SEG WD 12T1	1SYN869004R0036	12 way	T-max	12	36

IP43 with metal door

Product description	Product code	No of ways	No of modules		
			I/C	Sub I/C	O/G
S7SEG M 4 T1	1SYN869004R0037	4 way	T-max	12	12
S7SEG M 6 T1	1SYN869004R0038	6 way	T-max	12	18
S7SEG M 8 T1	1SYN869004R0039	8 way	T-max	12	24
S7SEG M 12 T1	1SYN869004R0040	12 way	T-max	12	36



Distribution boards

Classic series – dimensional drawing

IP 30 S7SEG WD T1 range

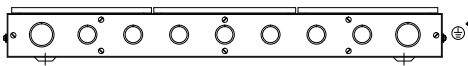
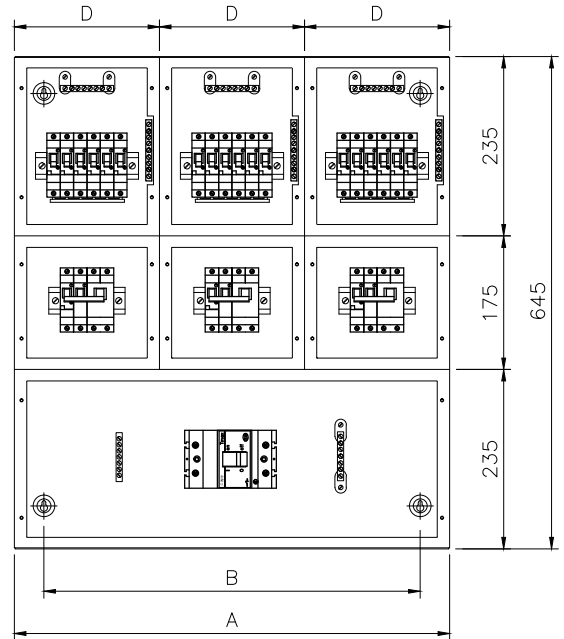
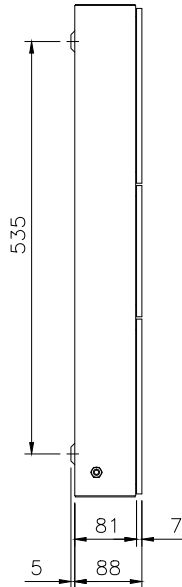
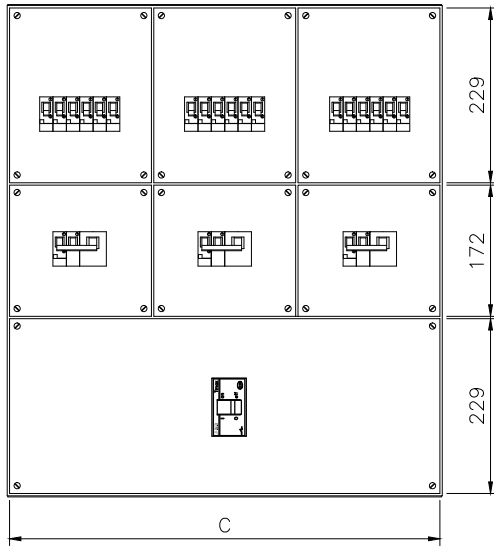

Code	Way	A	B	C	D	Top & Bottom Ø 26,K' out	Top & Bottom Ø 32,K' out
S7SEG T1 WD4	4	490	415	485	163	06 Nos	02 Nos
S7SEG T1 WD6	6	595	520	590	198	07 Nos	02 Nos
S7SEG T1 WD8	8	700	625	695	233	08 Nos	02 Nos
S7SEG T1 WD12	12	910	835	905	303	12 Nos	02 Nos

IP 43 S7SEG M T1 range

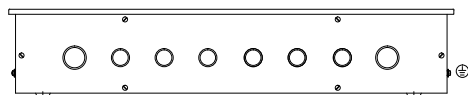
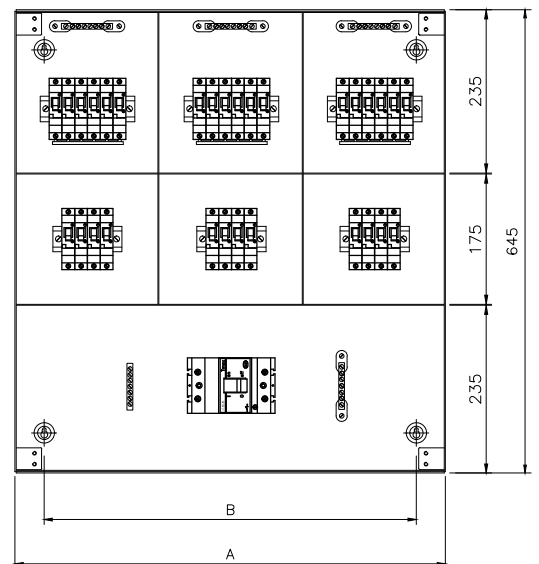
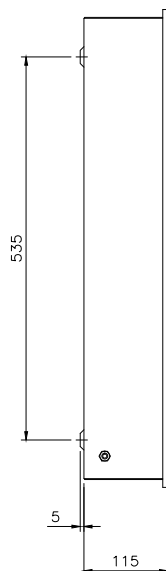
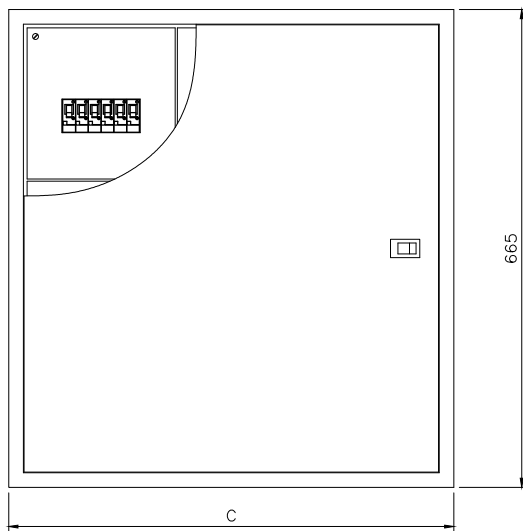

Code	Way	A	B	C	Top & Bottom Ø 26,K' out	Top & Bottom Ø 32,K' out
S7SEG T1 M04	4	430	355	450	4 Nos	2 Nos
S7SEG T1 M06	6	535	460	555	6 Nos	2 Nos

All dimensions are in mm

Distribution boards

Classic series – dimensional drawing

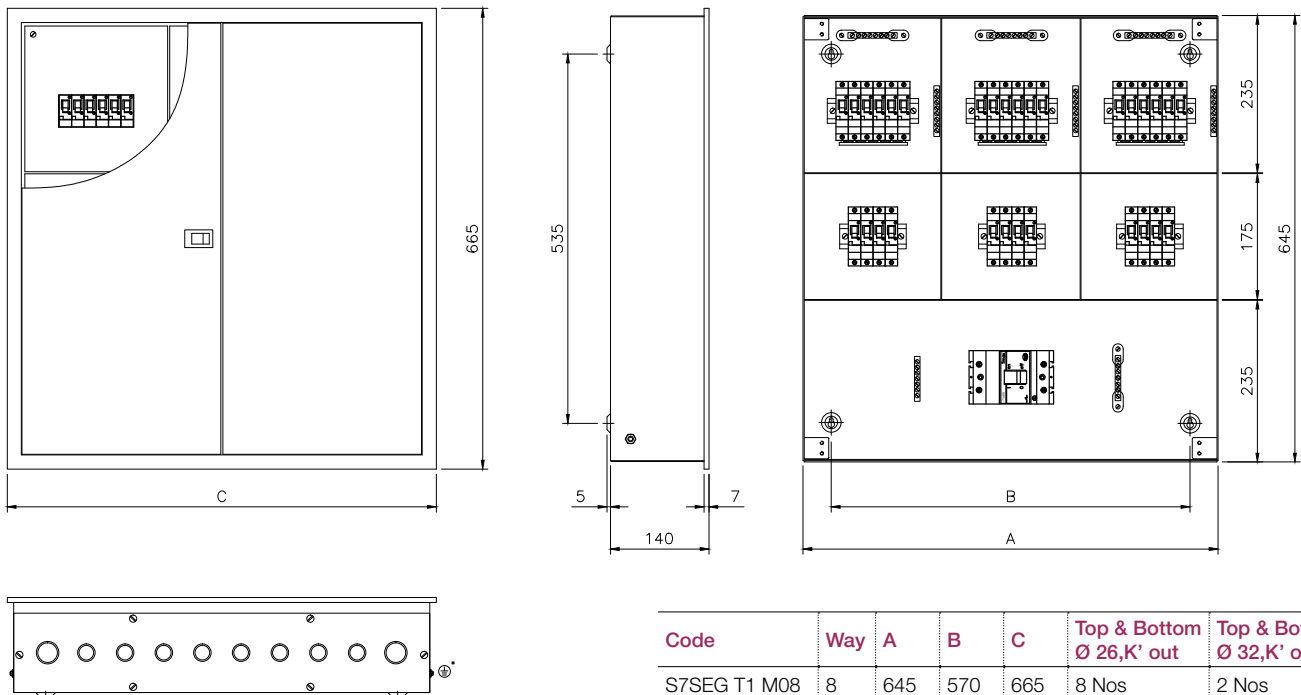

All dimensions are in mm

Distribution boards

Classic series – phase selector DB – SPVS



Phase selector distribution boards with inbuilt 3 numbers of selector switches and 3 numbers of piano switches as well as provision for 8 pole MCB / Isolator / RCD as incoming and SP MCBs as outgoing.

These distribution boards come with earth link, Neutral link, tinned electrolytic copper busbar and wire sets for cable management.

Top and bottom, removable gland plates with knockouts. Mounting of these boards can be flush or surface.

Available in IP 30 (without door)
IP 43 (with metal door)



IP 30

Product description	Product code	No of ways	No of modules	
			I/C	O/G
SPVS WD 4(63A)	1SYN869100SPWD1	4 way	8	12
SPVS WD 6(63A)	1SYN869100SPWD2	6 way	8	18
SPVS WD 8(63A)	1SYN869100SPWD3	8 way	8	24
SPVS WD 12(63A)	1SYN869100SPWD4	12 way	8	36
SPVS WD 4(40A)	1SYN869100SPWD5	4 way	8	12
SPVS WD 6(40A)	1SYN869100SPWD6	6 way	8	18
SPVS WD 8(40A)	1SYN869100SPWD7	8 way	8	24
SPVS WD 12(40A)	1SYN869100SPWD8	12 way	8	36

IP 43 with metal door

Product description	Product code	No of ways	No of modules	
			I/C	O/G
SPVS M 4(63A)	1SYN869100R0001	4 way	8	12
SPVS M 6(63A)	1SYN869100R0002	6 way	8	18
SPVS M 8(63A)	1SYN869100R0003	8 way	8	24
SPVS M 12(63A)	1SYN869100R0004	12 way	8	36
SPVS M 4(40A)	1SYN869100SP004	4 way	8	12
SPVS M 6(40A)	1SYN869100SP002	6 way	8	18
SPVS M 8(40A)	1SYN869100SP003	8 way	8	24
SPVS M 12(40A)	1SYN869100SP012	12 way	8	36

Distribution Boards

Classic series – dimensional drawing

IP 30 SPVS WD Range

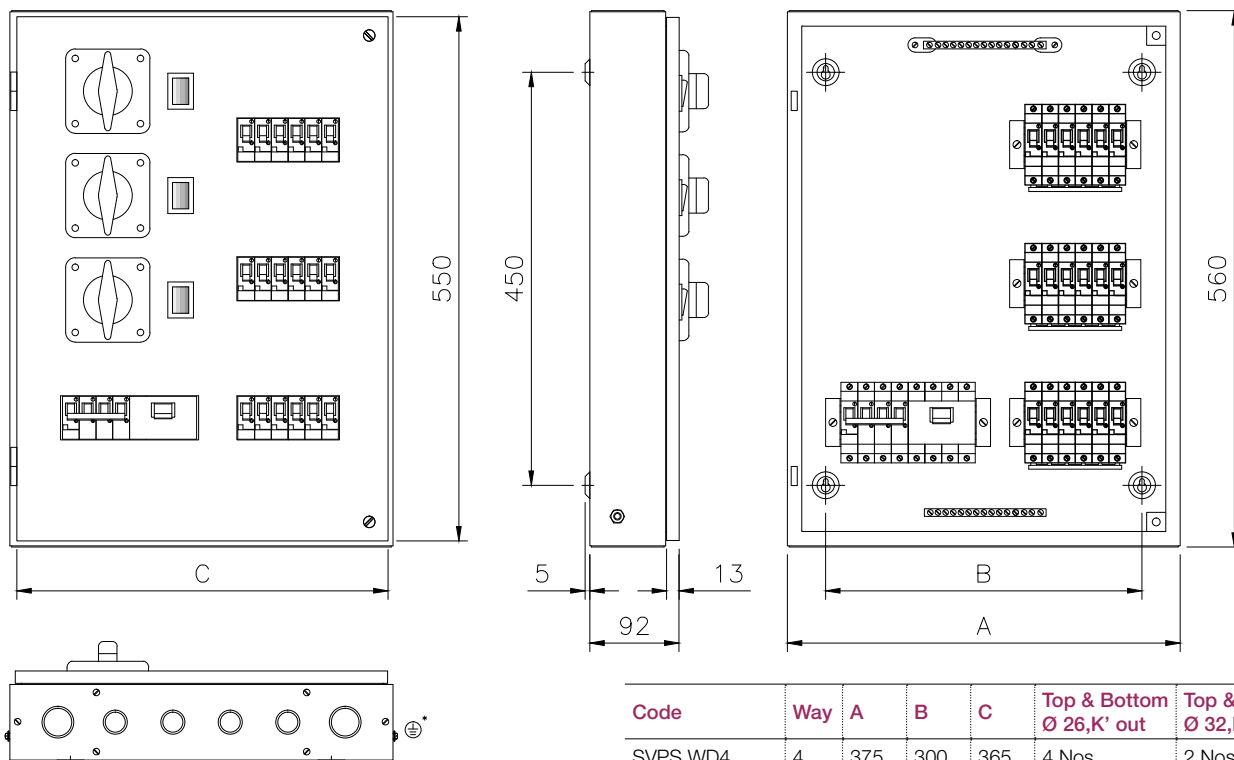

Code	Way	A	B	C	Top & Bottom Ø 26,K' out	Top & Bottom Ø 32,K' out
SVPS WD4	4	375	300	365	4 Nos	2 Nos
SVPS WD6	6	410	335	400	4 Nos	2 Nos
SVPS WD8	8	445	370	435	5 Nos	2 Nos
SVPS WD12	12	515	440	505	6 Nos	2 Nos

IP 43 SPVS M Range

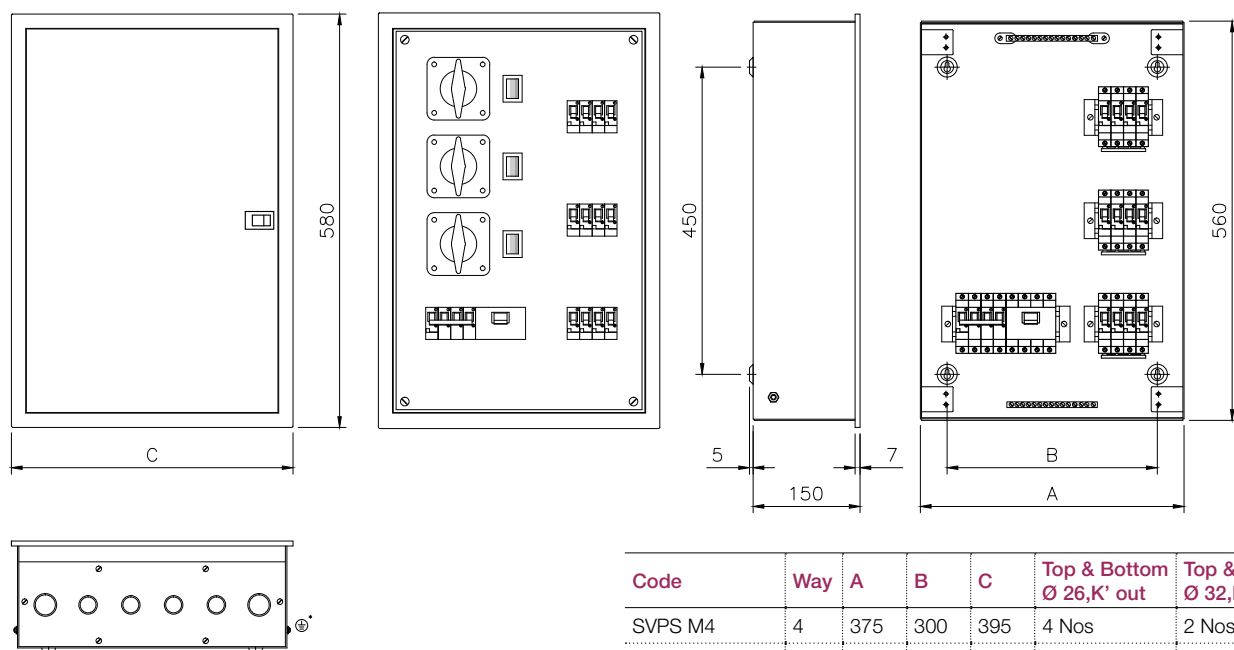

Code	Way	A	B	C	Top & Bottom Ø 26,K' out	Top & Bottom Ø 32,K' out
SVPS M4	4	375	300	395	4 Nos	2 Nos
SVPS M6	6	410	335	430	4 Nos	2 Nos
SVPS M8	8	445	370	465	5 Nos	2 Nos
SVPS M12	12	515	440	535	6 Nos	2 Nos

All Dimensions are in mm

Distribution boards

Classic series – metal enclosures – SEN



Classic series – SEN

Metal enclosures, universal mounting suitable for SP, DP, FP, 6P and 8 Pole arrangements

Product description	Product Code	No of ways	No of modules
SEN 1P	1SYN869054R0001	1P	1
SEN 2P	1SYN869055R0001	2P	2
SEN 4P	1SYN869056R0001	4P	4
SEN 6P	1SYN869057R0001	6P	6
SEN 8P	1SYN869004R0029	8P	8

SEN 1P, 2P and 4P

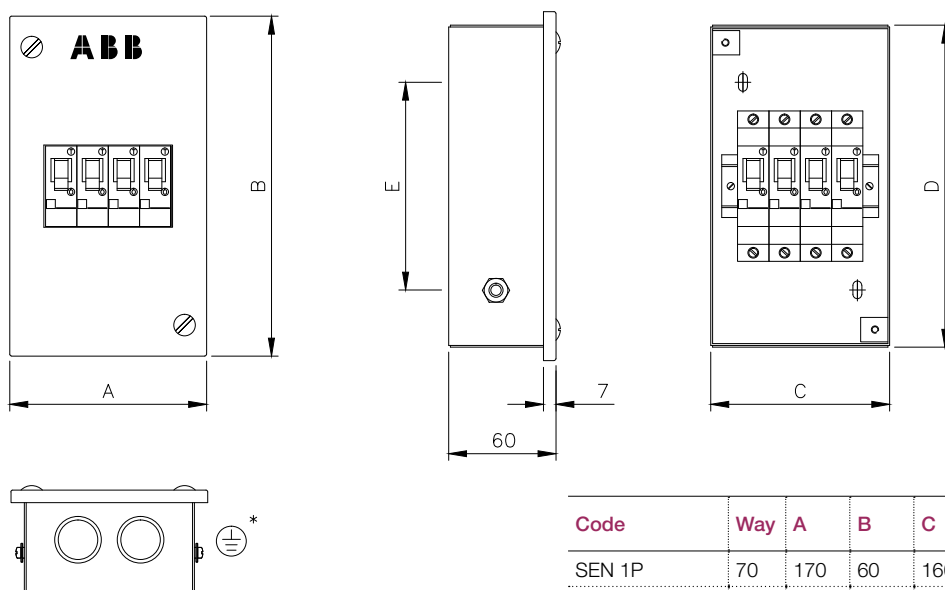

Code	Way	A	B	C	D	Top & Bottom Ø 26, K' out
SEN 1P	70	170	60	160	110	1
SEN 2P	70	170	60	160	110	1
SEN 4P	110	190	100	180	116	2

SEN 6P and 8P

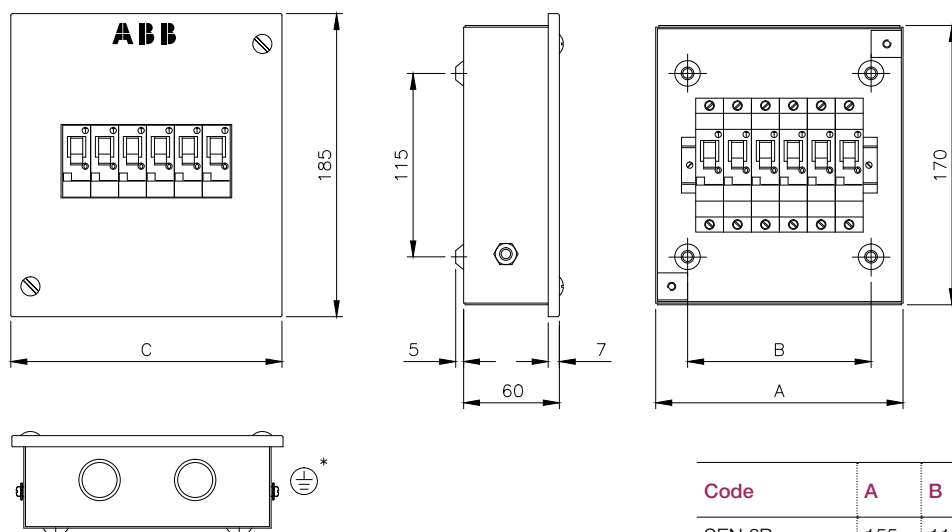

Code	A	B	C	Top & Bottom Ø 26, K' out
SEN 6P	155	110	170	2
SEN 8P	195	150	210	2

All dimensions are in mm

Distribution boards

Classic series – plug and socket DB – SGK



This range offers a wide variety of plug and sockets boards. These plug and sockets can be used for single phase or three phase application up to 63A along with MCB or RCBO with provision for universal mounting.

Plug and socket DB - SGK

Product description	Product Code	No of ways	No of modules
SGK 10 SP	1SYN869048R0001	10A SP	1
SGK 20 SP	1SYN869043R0001	20A SP	1

SGK 10 and 20 SP

Dimensions, same for SGK 10 and 20A with single pole and double pole provision

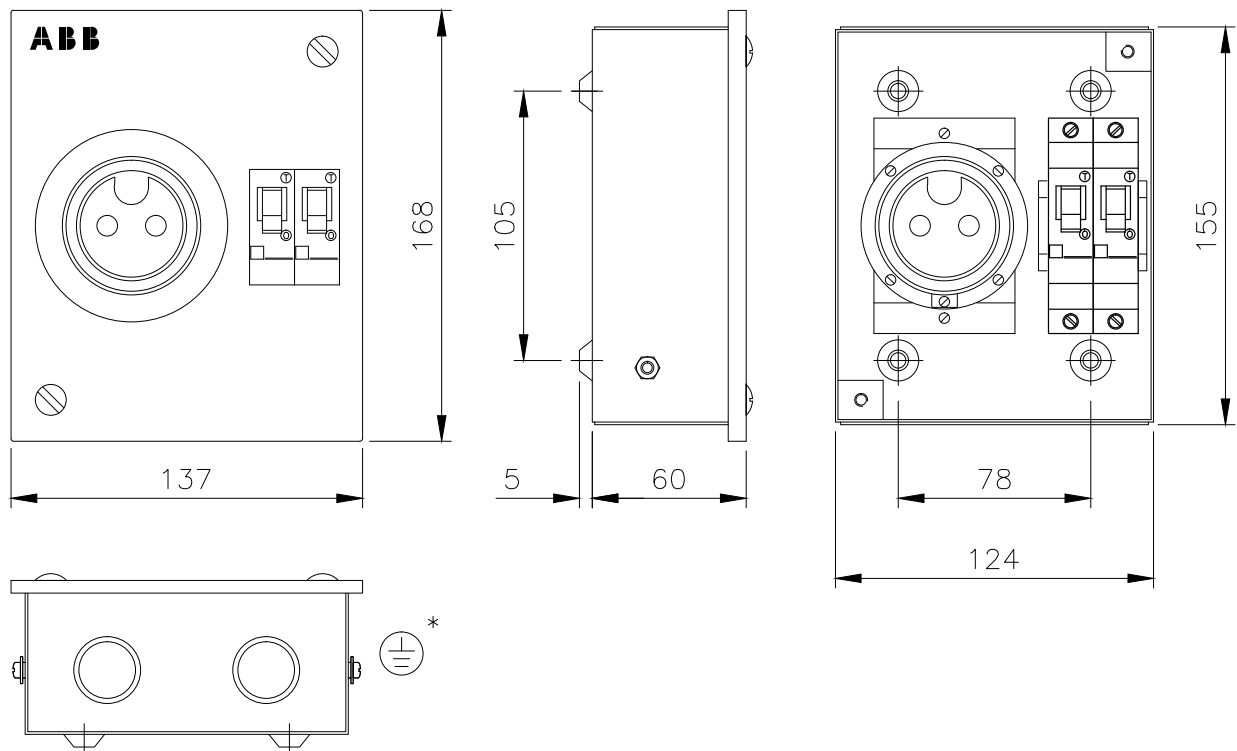

All dimensions are in mm

Distribution boards

Classic series – dimensional drawing

Plug and socket DB - SGK

Product description	Product code	No of ways	No of modules
SGK 20 TP	1SYN869049R0001	20A TP	3
SGK 30 TP	1SYN869044R0001	30A TP	3

SGK 20 and 30 TP

Dimensions, same for SGK 20 A and 30A with three pole provision

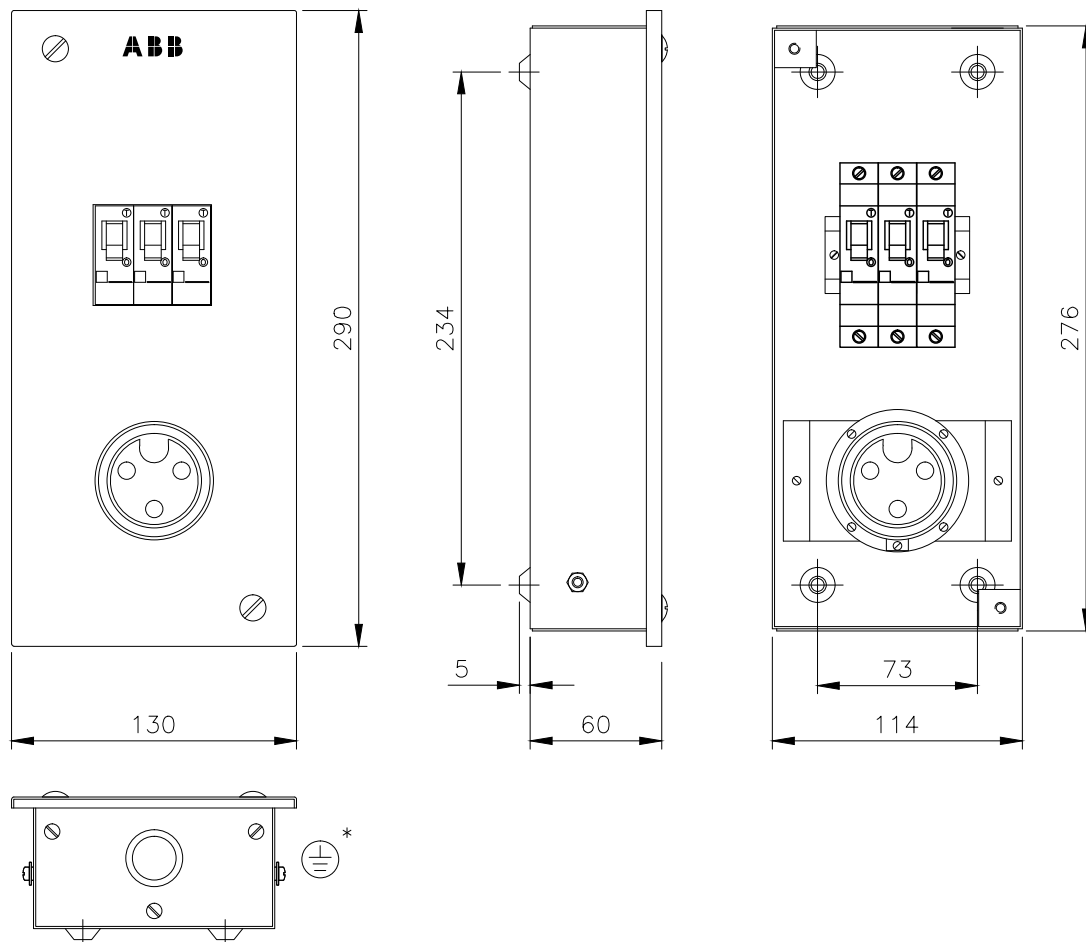

All dimensions are in mm

Distribution boards

Classic series – dimensional drawing

SGK 20 DPR

Plug and socket DB - SGK

Product description	Product code	No of ways	No of modules
SGK 20 DPR	1SYN869051R0001	20A DP RCBO	4

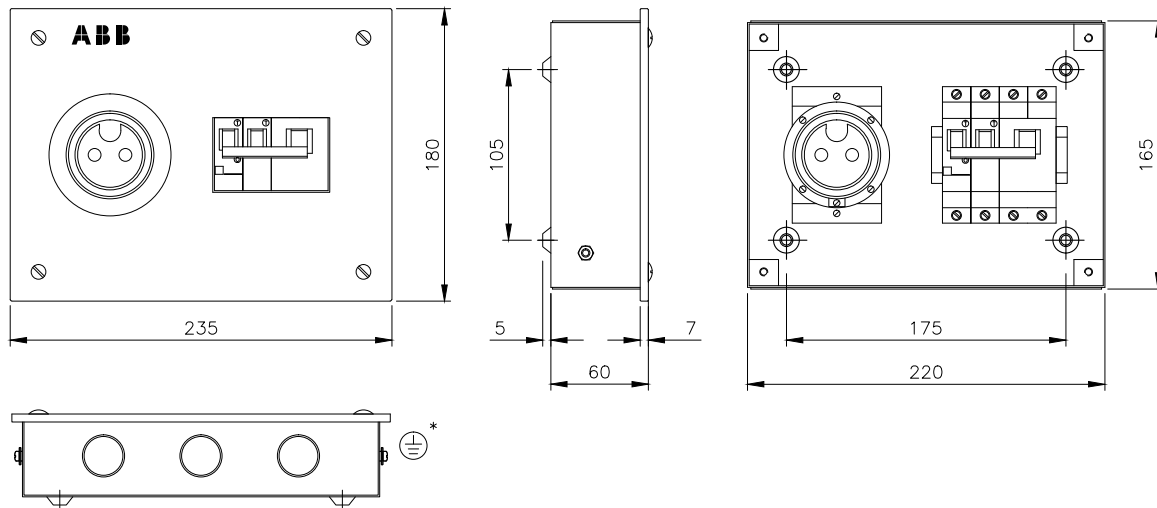

SGK 25 FPR

Plug and socket DB - SGK

Product description	Product code	No of ways	No of modules
SGK 25 FPR	1SYN869052R0001	25A FP RCBO	6

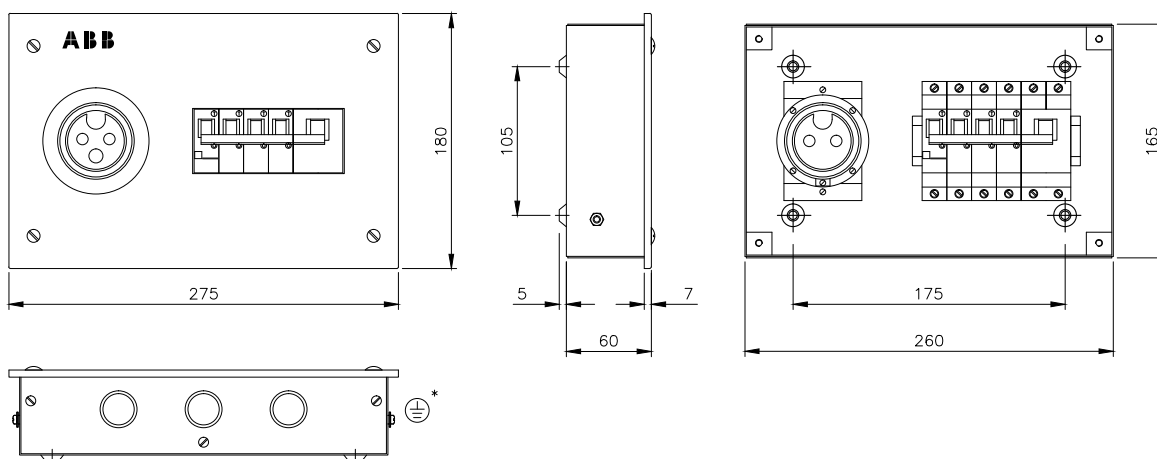

All dimensions are in mm

Distribution boards

Classic series – dimensional drawing

SGK 60 FP

Plug and socket DB-SGK

Product description	Product code	No of ways	No of modules
SGK 60 FP	1SYN869053R0001	60A FP	4

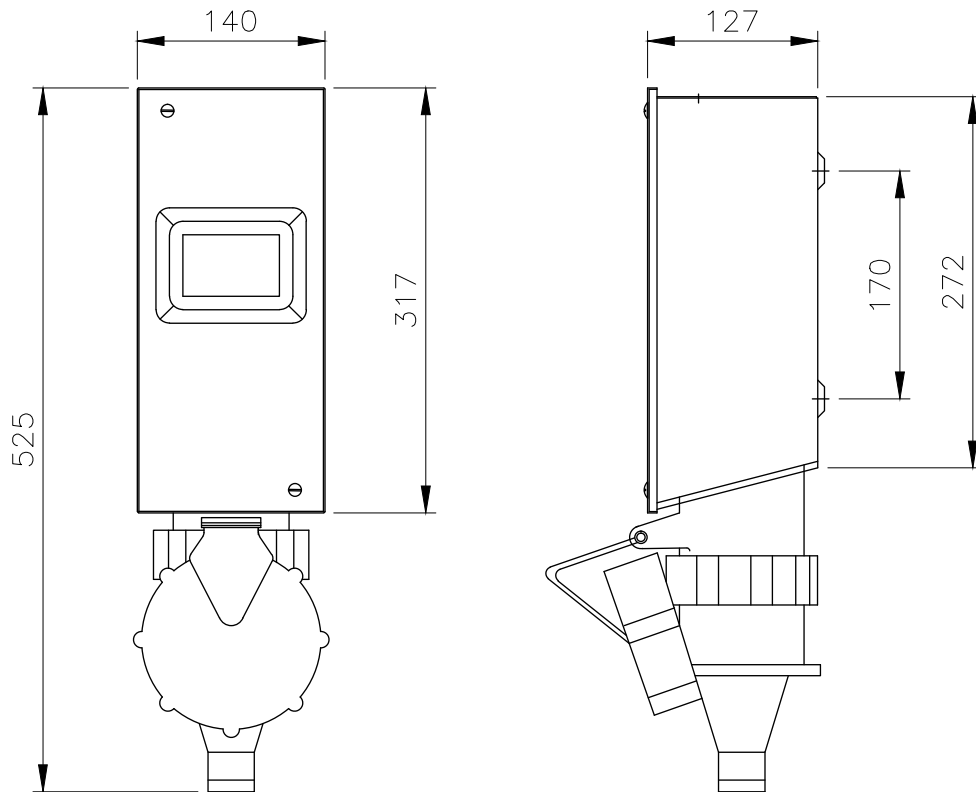

Distribution boards

Classic series

Classic series

Hole mounting dimension

Hole mounting dimension are common for all IP 30 and IP 43 Classic range distribution boards.

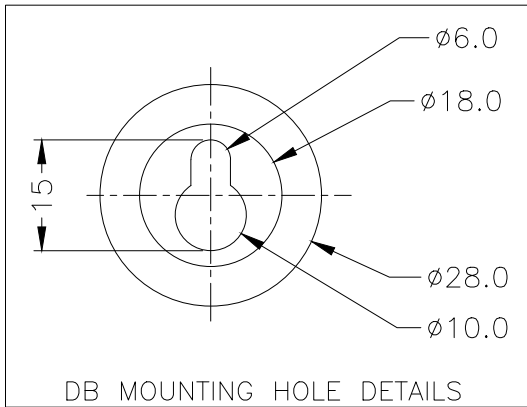

*  Earth screw

Contact us

ABB India Helpline:

Technical Telephone support for customers and channel partners.

☎ Tool Free: (BSNL) +91 1800 420 07 07

E-mail : lp.contactcenter@in.abb.com

www.abb.com/lowvoltage

Note: The data and illustrations are not binding. We reserve the right to modify the contents of the document on the basis of technical development of the products, without prior notice.