

KTS

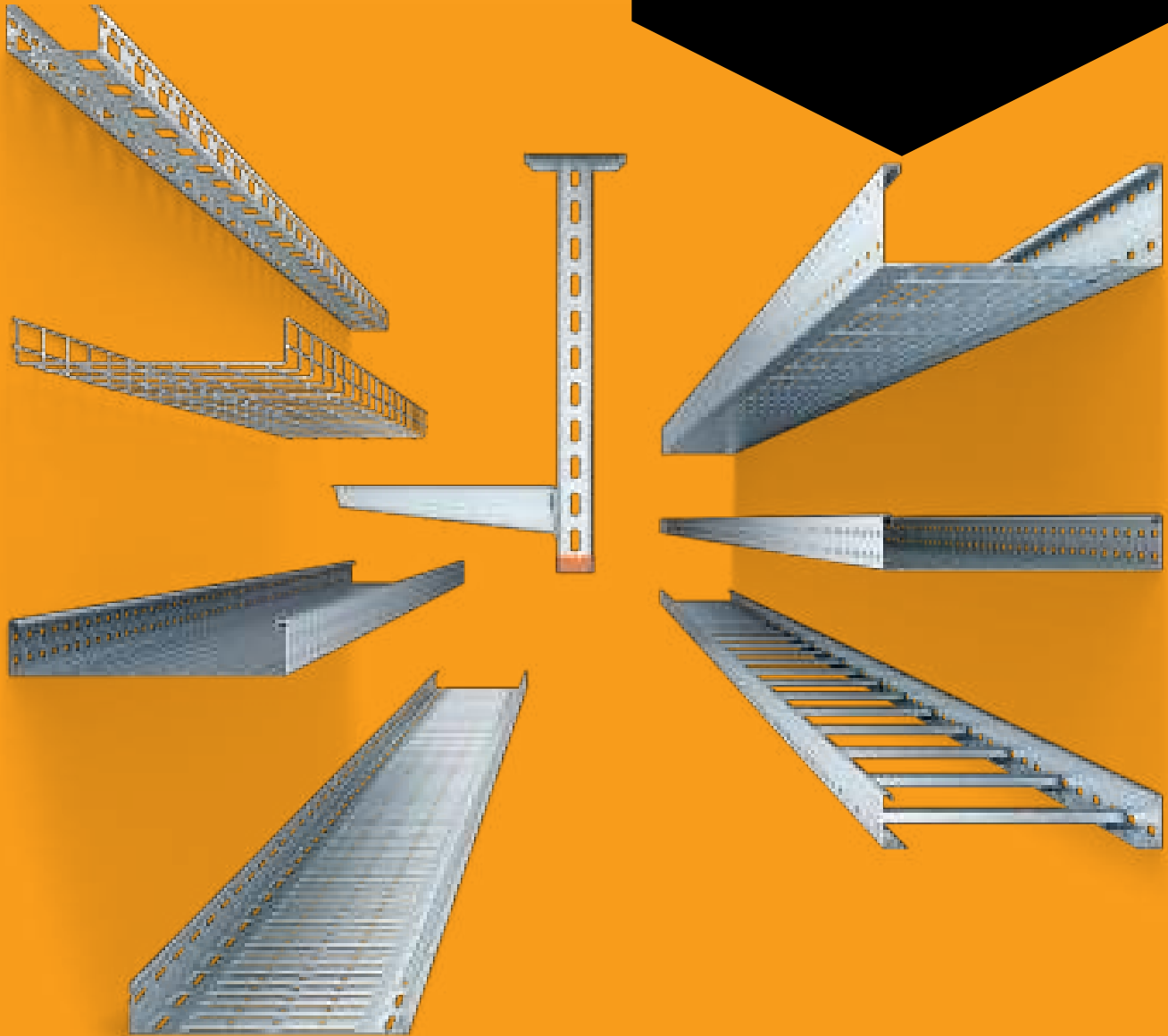

**Cable support
systems
India**

2020/2021

Building Connections

OBO
BETTERMANN









Contact
Customer Service
+91 (0)44 7103 3900

Service times
Monday to Friday 8.30 – 17.45

+91 (0)44 7103 3999



Contents

	General planning aids	4
	Mounting systems	43
	Fastening systems	67
	Cable tray systems	73
	Mesh cable tray systems	121
	Cable ladder systems	135
	Directories	147



OBO KTS seminars: First-hand knowledge

With a comprehensive range of training courses and seminars on cable support systems, OBO is able to provide users with first-hand support. Alongside the basic theoretical principles, the programme also deals with practical implementation in everyday applications. Special calculation and application examples round off the comprehensive programme of knowledge transfer.

Invitations to tender, product information and data sheets

We can make life easier for you, with our comprehensive selection of materials designed for practical applications, which provide you with effective support with the planning and calculation of a project. These include:

- Invitations to tender
- Product information
- Data sheets
- Data sheets

Invitations to tender for lightning protection/earthing at the highest level:

OBO manufacturers products to RAL GZ642-5 and is dedicated to compliance with the RAL directives. Lightning protection and earthing products can be used for invitations to tender according to RAL.

These documents are continually updated and can be downloaded for free at any time from the Internet download area at www.obo-bettermann.com.

Invitations to tender on the Internet at www.ausschreiben.de

More than 10,000 entries from the cable support systems, fire protection systems, connection and fastening systems, transient and lightning protection systems, cable routing systems, device systems and underfloor systems can be recalled for free. Regular updates and extensions mean that you always have a comprehensive overview of the OBO products. All the current file formats (PDF, DOC, GAEB, HTML, TEXT, XML, ÖNORM) are available. www.ausschreiben.de

The new generation is here: OBO Construct Professional and OBO Construct Web



We have reinvented our Construct planning software: We have bundled all the electronic planning aids under the name OBO Construct.

Two versions

There are now two versions of OBO Construct: Construct Web and Construct Professional. They are now aligned to the different requirements of our customers and offer the following scope of service:

OBO Construct Professional

The completely new tool for professional users. The new multilingual AutoCAD plug-in is available in various languages and offers a wealth of benefits:

- Redesigned user dialogues
- Simplified operation
- Improved component depiction
- Individual adjustment of object display
- Completely new system (runs on 64-bit systems)
- Mass determination with additional materials
- Output of the mass determination in various formats (Excel, PDF, Text)
- Simple updates
- Importable and editable invitations to tender

OBO Construct Web

The Internet version for rapid help now no longer needs a CAD system and offers the following benefits:

- Simple operation
- For quick and easy application
- Platform-independent
- No installation required
- Access possible from anywhere
- Option of saving project data
- Plans can be printed out as PDFs
- Exact mass determination in an Excel file
- Additional material bookable



OBO Construct KTS: Project planning, drawing and generation



Find out now

Convince yourself about the new OBO Construct: a new support and training concept makes it easier than ever for you to take your first steps. You can find additional information on the Internet or from our Customer Service.

AutoCAD is a registered trademark of Autodesk Incorporation, USA.



Standards, specifications and certifications



Standards

OBO offers products for professionals, made by professionals: Our products are manufactured and tested according to the respective specifications of the standards. For example, DIN EN 61537 describes all the relevant parameters for cable support systems, such as the area of application, test conditions, corrosion resistance and temperature classification. As a highly competent manufacturer, OBO subjects itself to these requirements on a daily basis. Comprehensive test procedures guarantee that systems which conform to standards function safely.

Specifications

All the OBO products and systems are CE-compliant according to the appropriate EC guidelines. This also applies to standard parts such as bolts, washers and nuts that are components of various product systems. The appropriate EC declaration of conformity certifies agreement with the named directives or standards, but does not guarantee properties. The safety instructions in the product information and the general safety regulations must be complied with during installation and use.

Certifications

For OBO, product quality is closely connected to continuous testing and checking – which is why we manufacture almost all our products ourselves. This enormous depth of production is an expression of our demand for quality. From construction, and the materials used through production, right up to logistics, our employees personally guarantee the quality and availability of OBO products. The multitude of approvals emphasise our high demand for quality and product functionality. Our integrated quality management system forms the solid basis of our ISO 9001 certification, which we have held since 1994. The confirmation of suitability enables defined and workable processes in accordance with KTA 1401 and 10 CFR 50.

Inclusion of the protective measures



Load tests for cable support systems

All the OBO articles and systems are subjected to practical load testing. The basic principles for the tests of OBO cable support systems are included in IEC 61537. After the load test, the maximum load capacity can be determined for each component, depending on the support distances and specific article parameters, such as component dimensions. This is all shown in a chart, included with each component.

You can find additional information on the load tests for cable trays, brackets and suspended supports in this catalogue. The values given do not take resistance against environmental forces such as snow, wind and other outside influences into account.



Definition of electromagnetic compatibility (EMC)



Recent years have seen the use of electronic circuits increase continually. Whether in industrial systems, medicine, households, telecommunications systems, vehicles or electrical building installations – we find powerful electrical equipment and systems everywhere, and these switch ever greater currents, achieve greater radio ranges and transport ever more power in smaller spaces.

However, the use of state-of-the-art technology means that the complexity of applications also increases. The consequence of this

is that ever more opposing influences (electromagnetic interferences) can occur from system parts and cables, causing damage and economic losses.

Here, we talk of electromagnetic compatibility.

Electromagnetic compatibility (EMC) is the ability of an electrical unit to function satisfactorily in its electromagnetic environment, without inappropriately influencing this environment, to which other units also belong (VDE 0870-1). In terms of standardisation, electromagnetic compatibility is dealt with

by the EMC Directive 2004/108/EC. This means that electrical resources emit electromagnetic interferences (emissions), which are picked up by other devices or units (immision) that act as receivers (interference sink). This in turn means that the function of an interference sink can be severely reduced and, in the worst-case scenario, total failure and economic losses. The interferences can then spread along cables or in the form of electromagnetic waves.

Path of faults

Fault source (transmitting emissions)	Coupling of interference variables (spreading of interference)	Fault sink (receiving emissions)
For example - Mobile telephones - Switching components - Ignition systems - Frequency converters - Lighting strike - Welding devices	- Galvanic - Inductive - Capacitive - Electromagnetic	- Process computer - Radio receiver systems - Controllers - Converters - Measuring units

Guarantee of EMC



Guaranteeing EMC

A systematic planning process is necessary to guarantee EMC. The interference sources must be identified and quantified. The coupling describes the spread of the interference from the interference source up to the device being influenced, the interference sink. The task of EMC planning is to ensure the compatibility at the source, coupling path and sink using suitable measures. During their daily work, planners and installation engineers are confronted with this subject on an increasingly regular basis. This means that EMC is a basic factor to be taken into consideration during the planning of installations and cabling systems. Due to the high complexity of electromagnetic compatibility, the problems of EMC must be analysed and solved using simplifying hypotheses and models, as well as experiments and measurements.

Cable support systems and their contribution to EMC

Cable support systems can make an important contribution to the improvement of EMC. They are passive and can thus make a safe, long-lasting contribution to EMC through the fact that cables are run within cable support systems or are shielded by them. Routing cables inside cable support systems greatly reduces the galvanic decoupling and coupling due to electrical and magnetic fields in the cables. Thus cable support systems can make a contribution to the reduction of coupling from the source to the sink. The shielding action of cable support systems can be quantified by the coupling resistance and the shield attenuation. This gives the planner important engineering parameters for cable support systems for EMC engineering.

Lightning discharge

From the analysis of the effectiveness of EMC in buildings (EN 62305-4), we know that lightning discharge is one of the greatest sources of interference to be expected. This causes a direct current feed into the entire equipotential bonding system in the building and/or to magnetic decoupling of interference currents in electrical cables. With regard to these couplings, cable support systems can offer an effective contribution to the reduction of interference voltages.

Magnetic shield insulation of cable support systems

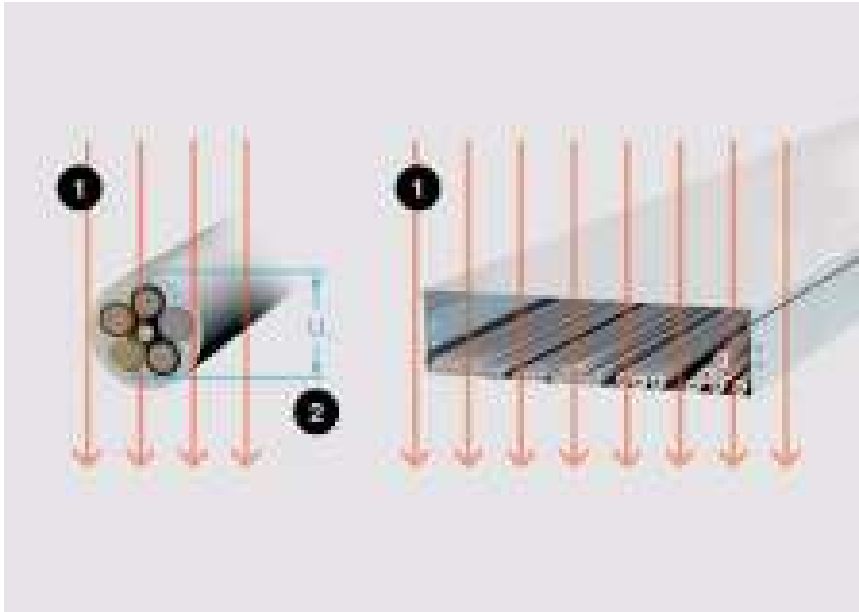

The magnetic field (H) of strength 3 kA/m in a defined experimental setup: without cable support system on the left, with cable support system on the right. 1 = Field H, 2 = $V_{1\text{ LZuPE}}$

The magnetic shield insulation of cable support systems is the ratio in decibels (dB) of an induced voltage into an unprotected cable to the induced voltage into the same cable, when this is in a cable support system.

Experimental structure to determine the magnetic shield insulation of cable support systems:

An unshielded cable (NYM-J 5x6 mm²) is subjected to an 8/20 magnetic field with a strength of 3 kA/m. Here, the induced voltage

V1 is measured in the unshielded cable. The same cable is then positioned in the centre of a cable support system (once with a cover, once without) and subjected to the same magnetic field of 3 kA/m. Here, the induced voltage V2 is measured in the unshielded cable. The magnetic shield insulation is calculated from the measured values according to the formula:

$$\alpha_s = 20 \log (V1/V2) \text{ dB}$$

Experiment result:

The magnetic shield effect α_s of a cable support system could be clearly proved by the experiments and the simulation with an FEM program. The best result of around 50 dB was achieved with cable support systems (cable trays) with covers.

Note:

The shield insulation against electrical fields is almost perfect, as it is with a Faraday cage.

Magnetic shield insulation 8/20 dB

Type, cable tray/cable ladder	Without cover	With cover
RKSM 630 FS	20	50
MKS 630 FS	20	50
MKS 630 FT	20	50
MKSU 630 FS	20	50
MKSU 630 FT	20	50
MKSU 630 VA	20	50
GRM 55/300 FS	15	25
LG 630 NS FT	10	15

Transfer impedance of cable support systems



Experimental structure for transfer impedance: 1 = Length l, 2 = U, 3 = I, 4 = Pulse source 8/20



$$Z_T = \frac{U_{8/20}}{I_{8/20} \cdot L}$$

Z_T : Transfer impedance

$V_{Interference}$: Interference voltage measured in cable

$I_{Interference}$: Interference current, fed into the shield from outside (KTS)

L: Length of the cable support system

Transfer impedance (coupling resistance) of cable support systems

The transfer impedance of a cable support system is the ratio of the measured voltage $V_{Interference}$, measured in the lengthwise direction within the cable support system, to the coupled current $I_{Interference}$.

The transfer impedance is determined in the same way as with the measurement of the electrical conductivity properties in Chapter 11.1. (DIN EN 61537).

If there is a lightning strike in a building, partial currents will flow through the entire equipotential bonding system.

Installed cables are best run within a cable support system. Installed

cable support systems are always included in the equipotential bonding system. In so doing, the partial current flows via the cable support system. A very small component can therefore still flow along the cables laid within the cable support system. This component is determined by the transfer impedance of the cable support system. The following applies for the transfer impedance:

$$Z_T = V_{Interference} / (I_{Interference} \times L) \text{ [m}\Omega\text{/m]}$$

The values given are based on measurements, in which a pulse current of the wave shape 8/20 was passed through a defined length of a cable support system.

Experiment result:

The effect of the cable support system against galvanic coupling was clearly proved by the experiments.

The best result was achieved with cable support systems (cable trays) with covers.

Transfer impedance 8/20 mOhm/m

Type, cable tray/cable ladder	Without cover	With cover
MKS 630 FS	1.14	0.71
MKS 630 FT	1.14	0.71
MKSU 630 FS	0.44	0.09
MKSU 630 FT	0.44	0.09
GRM 55/300 FS	6.17	5.5



Contact corrosion



Contact corrosion between two different metals poses a considerable risk to the load capacity and lifespan of the components used.

The level of contact corrosion is determined primarily by the level of the potential difference between the contact partners. Contact corrosion occurs at potential differences of 100 mV or greater and the anodic (electrically negative) partner is at risk of corrosion. Therefore, strongly non-precious metals should never be brought into contact with precious metals.

Additional contact corrosion criteria:

- Level of electrical resistance between the contact partners. The higher the resistance, the lower the contact corrosion. Positive on Al and Ti.
- Occurrence of an electrolyte. An electrolyte, such as perspiration or condensation, attacks the protective layers, increasing conductivity. Dirt increases this effect through released ions.
- Length of the impact of the electrolyte. The longer the electrolyte is active, the greater the corrosion will be.
- The surface ratios of the contact partners influence the current density. The best thing to have is a small surface ratio of the "precious" to the "less precious" contact partner.
- Different environments or atmospheres can increase or influence the risk of contact corrosion to varying degrees.

Potential difference

Normal potential		Practical voltage series, water pH 6		Practical voltage series, artificial seawater pH 7.5	
Metal	mV	Metal	mV	Metal	mV
Copper	+340	Titanium	136	Nickel	1
Lead	-126	Brass MS 63	100	Brass MS 63	32
Tin	-140	Copper	94	Copper	-35
Nickel	-230	Nickel	73	RF steel 1.4301	-90
Iron	-440	RF steel	-129	Titanium	-156
Zinc	-763	Aluminium	-214	Lead	-304
Titanium	-1630	Hard chromium	-294	Hard chromium	-336
Aluminium	-1660	Tin 98	-320	Steel	-380
Magnesium	-2370	Lead 99.9	-328	Aluminium	-712
Steel	-395				
Zinc	-852				

Contact corrosion



Land climate

Construction part material (large)		Construction element material (small)					
OBO designation	Basic material Coating	FT	VA	Al	Cu	MS	Zamak
Steel, galvanised (FT, FS, DD, G)	DD11/Zn, S234 (St37)/Zn, ST4-2/Zn, St500-2/Zn, StW22/Zn, DX51D/Zn	0	0	0	2	1	0
Stainless steel V2A, V4A, V5A	1.4301, 1.4310, 1.4401, 1.4404, 1.4571, 1.4529	0	0	1	1	1	0
Aluminium Al	AlMg3, AlMgSi0.5	0	0	0	2	1	0
Copper Cu	E-Cu S7, F24, Se-Cu (2.0070), SF-Cu F24, St50-2	1	1	1	0	1	2
Brass MS1	CuZn39Pb3, CuZn40Pb2	0	1	1	1	0	2
Brass MS2	CuZn37	0	2	1	1	0	2
Die-cast zinc Zamak ZnAlCu1	Z410 (GD-ZnAl4Cu1)	1	1	0	3	1	0

Legend

0 No risk for contact corrosion

1 Low risk

2 Risk in case of small area ration (area of non-precious metal/area of precious metal)

3 High risk

Contact corrosion



Industrial atmosphere

Construction part material (large)		Construction element material (small)					
OBO designation	Basic material Coating	FT	VA	Al	Cu	MS	Zamak
Steel, galvanised (FT, FS, DD, G)	DD11/Zn, S234 (St37)/Zn, ST4-2/Zn, St500-2/Zn, StW22/Zn, DX51D/Zn	0	0	1	3	2	0
Stainless steel V2A, V4A, V5A	1.4301, 1.4310, 1.4401, 1.4404, 1.4571, 1.4529	0	0	1	1	1	0
Aluminium Al	AlMg3, AlMgSi0.5	1	1	0	2	2	0
Copper Cu	E-Cu S7, F24, Se-Cu (2.0070), SF-Cu F24, St50-2	2	2	3	0	1	2
Brass MS1	CuZn39Pb3, CuZn40Pb2	1	1	2	1	0	1
Brass MS2	CuZn37	1	1	3	1	0	1
Die-cast zinc Zamak ZnAlCu1	Z410 (GD-ZnAl4Cu1)	0	0	0	3	2	0

Legend

- 0 No risk for contact corrosion
- 1 Low risk
- 2 Risk in case of small area ration (area of non-precious metal/area of precious metal)
- 3 High risk

Contact corrosion



Maritime climate

Construction part material (large)		Construction element material (small)					
OBO designation	Basic material Coating	FT	VA	Al	Cu	MS	Zamak
Steel, galvanised (FT, FS, DD, G)	DD11/Zn, S234 (St37)/Zn, ST4-2/Zn, St500-2/Zn, StW22/Zn, DX51D/Zn	0	1	3	3	2	1
Stainless steel V2A, V4A, V5A	1.4301, 1.4310, 1.4401, 1.4404, 1.4571, 1.4529	1	0	3	1	1	0
Aluminium Al	AlMg3, AlMgSi0.5	3	1	0	2	2	0
Copper Cu	E-Cu S7, F24, Se-Cu (2.0070), SF-Cu F24, St50-2	2	2	3	0	1	2
Brass MS1	CuZn39Pb3, CuZn40Pb2	1	1	3	1	0	1
Brass MS2	CuZn37	1	1	3	1	0	1
Die-cast zinc Zamak ZnAlCu1	Z410 (GD-ZnAl4Cu1)	0	0	0	3	2	2

Legend

0 No risk for contact corrosion

1 Low risk

2 Risk in case of small area ration (area of non-precious metal/area of precious metal)

3 High risk

Surface testing and corrosion categories



Salt spray test

All the system components must show sufficient resistance against corrosion in agreement with the KTS standard, DIN EN 61537. The minimum zinc layer thicknesses are determined through a measurement. The grouping into the appropriate class is located in the lower table on the next page. The top table on the next page presents the area of use and the zinc reduction to be expected according to DIN EN ISO 12944.

Surface testing and corrosion categories

Classification of corrosion resistance according to EN 61537

Class	Reference material and surface treatment
0*	None
1	Electroplated to a minimum thickness of 5 µm
2	Electroplated to a minimum thickness of 12 µm
3	Pre-galvanised to grade 275 to EN 10327 and EN 10326
4	Pre-galvanised to grade 350 to EN 10327 and EN 10326
5	Post-galvanised to a zinc mean coating thickness (minimum) of 45 µm according to ISO 1461
6	Post-galvanised to a zinc mean coating thickness (minimum) of 55 µm according to ISO 1461
7	Post-galvanised to a zinc mean coating thickness (minimum) of 70 µm according to ISO 1461
8	Post-galvanised to a zinc mean coating thickness (minimum) of 85 µm according to ISO 1461 (usually high silicon steel)
9A	Stainless steel manufactured to ASTM: A 240/A 240M – 95a designation S30400 or EN 10088 grade 1-4301 without a post-treatment *
9B	Stainless steel manufactured to ASTM: A 240/A 240M – 95a designation S31603 or EN 10088 grade 1-4404 without a post-treatment *
9C	Stainless steel manufactured to ASTM: A 240/A 240M – 95a designation S30400 or EN 10088 grade 1-4301 with a post-treatment **
9D	Stainless steel manufactured to ASTM: A 240/A 240M – 95a designation S31603 or EN 10088 grade 1-4404 with a post-treatment **

* For materials which do not have a declared corrosion resistance classification

** The end treatment process is used to improve the protection against crack corrosion and the contamination of other steels

Corrosion categories to DIN EN ISO 12944

Corrosion category	Typical environment, inside	Typical environment, outside	Corrosion load	Average zinc removal
C 1	Heated buildings with neutral atmospheres, e.g. offices, shops, schools, hotels	-	Insignificant	<0.1 µm/a
C 2	Unheated buildings in which condensation can occur, e.g. warehouse, sports halls	Atmosphere with low level of impurities. Often rural areas	Low	0.1 to 0.7 µm/a
C 3	Production facilities with a high level of humidity and some air impurities, e.g. plants for food production, laundries, breweries, dairies	City and industrial atmosphere, considerable impurities through sulphur dioxide, coastal areas with low salt load	Medium	0.7 to 2.1 µm/a
C 4	Chemical plants, swimming pools, boat sheds over seawater	Industrial areas and coastal areas with low salt load	Strong	2.1 to 4.2 µm/a
C 5-I	Buildings or areas with almost constant condensation and with high levels of impurities	Industrial areas with high levels of humidity and aggressive atmosphere	Very strong (industry)	4.2 to 8.4 µm/a
C 5-M	Buildings or areas with almost continuous condensation and with high levels of impurities	Coastal or offshore areas with salt load	Very strong (sea)	>4.2 to 8.4 µm/a



Whether indoors or outdoors, in aggressive atmospheres or under special hygienic conditions: OBO can offer the perfect surface and materials for your cable support system, no matter what the requirements may be. OBO cable support systems are machined from high-quality sheet steel or steel wire and are available with various surfaces. Different hardening and coating methods ensure tailor-made corrosion protection, specially tailored to the appropriate application. In addition, OBO cable support systems are available in stainless steel and with coloured coatings.

Indoor use

For applications in indoor areas, OBO can offer cable support systems with galvanisation or strip galvanisation. They are particularly suited to dry atmospheres without any impact from aggressive pollutants.

Electro-galvanisation

- Electrolytic galvanisation in accordance with IEC 12329
 - Average coating thickness approx. 2.5–10 μm
 - According to RoHS guideline
- Components: Mesh cable trays and small parts such as bolts, washers and nuts.

Strip galvanisation

- Hot-dip galvanised according to the strip-galvanising method in accordance with IEC 10346 (formerly IEC 10327)
- Average coating thickness approx. 20 μm
- Joints in the metal are protected by cathodic corrosion protection up to a thickness of 2.0 mm

Components: Metal products such as cable trays, fittings and barrier strips.

Surfaces for outdoor use



Outdoor use

OBO can offer versions with hot-dip galvanisation and double-dip galvanisation for outdoor and wet-room use.

Hot-dip galvanisation

- Hot galvanisation using the dipping method according to DIN EN ISO 1461
- Coating thickness to DIN EN ISO 1461 approx. 40–60 μm
- Any interfaces added at a later date must also be galvanised to protect against corrosion

Components: Sheet steel products such as cable trays and welded components such as supports and brackets.

Double-dip galvanisation

- Hot dipping with zinc-aluminium coating in accordance with DIN EN 10346
- Average coating thickness approx. 23 μm
- Joints in the metal are protected by cathodic corrosion protection up to a thickness of 2.0 mm

Components: Metal products such as covers, barrier strips and punched parts.

Surfaces for use in the chemical industry, the foodstuff industry or in tunnel construction



Applications: Tunnel construction, food or chemical industries

For special hygiene and quality requirements, as well as for special visual criteria for open wiring, there are also OBO stainless steel systems.

V2A stainless steel

- OBO code: V2A
- European material number: 1.4301
- American material designation: 304
- Welded components are additionally passivated
- Unwelded components are rinsed and degreased

Product range: V2A programme with the title "Stainless steel systems V2A".

SS4 stainless steel

- OBO code: V4A
- European material number: 1.4571
- American material designation: 316 / 316 Ti
- Welded components are additionally passivated
- Unwelded components are rinsed and degreased

Product range: V4A programme with the title "Stainless steel systems V4A".

Surfaces for special visual requirements or special environmental loads



Applications with specific optical requirements or special environmental conditions

Colour-coated products are becoming ever more popular. The coating may be required for optical reasons or for reasons of corrosion protection.

Colour coatings for reasons of corrosion protection

- Products in FT (hot-dip galvanised version)
- All RAL colours available
- Coating of the visible surfaces or the complete system
- Suitable for the colour of the structure when routed openly
- Separation of different voltages/functions (e.g. blue 230/400 V power supply; red weak current such as telephone cables and IT)

Colour-coated systems are not indicated specially in this catalogue. You can obtain details of these systems by contacting our telephone hotline on +49 (0)2373 89-1238.

Which cabling method is used?



Cable types

Not all cables are the same. To select the perfect cable support system, you need to know which type of cables are to be laid: Are they sensitive data cables, which must be laid at a certain distance from each other on account of the necessary shielding? Or power cables, for which a not inconsiderable heat build-up must be taken into account? For all these applications OBO can offer tailor-made system solutions.





Universal cable trays

Areas of application: From low-voltage cabling to power supply.



Mesh cable trays for the installation of light cables

Areas of application: IT cabling, telephone cabling and control cables. Also suitable for use in false ceilings and cavity floors.



Cable ladders for power cables with a large cross-section

Areas of application: Cables and power conductors with large cross-sections. These can be fastened to the rungs using clamp clips. The high load capacity and good ventilation ensure perfect cable laying.



Wide span cable trays and ladders for large support distances

Areas of application: For installations in which the support distances are more than three metres, on account of the construction conditions.



Modular system for special tasks

The product range that knows no bounds. The range of individually combinable products is particularly suited to complex installation tasks.



AZ small duct for universal use

Areas of application: from luminaire support systems to low-voltage cabling and power supply.

How can I work out the volume of cables?



The usable cross-section of the cable simulates the cavity in real laying.



Cable diameter (1) and space required (2)

An important criteria for the selection of the correct cable support system is the cable volume, for which there must be sufficient space in the cable tray. As the cables are never packed tightly together or are absolutely parallel, it is not enough to base the volume calculation solely on the cable diameter. A realistic calculation is provided by the formula $(2r)^2$. To save you work, we have listed the diameter and usable cross-section of the most important cable types below.

Important: These values are average values, which may vary from manufacturer to manufacturer. Please refer to the manufacturer's specifications for the exact values.

Calculation with the formula $(2r)^2$

The diameter says little about the actual space required by a cable. Calculate: $(2r)^2$. This value reflects the realistic space requirements, including the compartments.

Cable volume



Insulated power cables

Type	Diameter mm	Usable cross-section cm ²
1 x 4	6.5	0.42
1 x 6	7	0.49
1 x 10	8	0.64
1 x 16	9.5	0.9
1 x 25	12.5	1.56
3 x 1.5	8.5	0.72
3 x 2.5	9.5	0.9
3 x 4	11	1.21
4 x 1.5	9	0.81
4 x 2.5	10.5	1.1
4 x 4	12.5	1.56
4 x 6	13.5	1.82
4 x 10	16.5	2.72
4 x 16	19	3.61
4 x 25	23.5	5.52
4 x 35	26	6.76
5 x 1.5	9.5	0.9
5 x 2.5	11	1.21
5 x 4	13.5	1.82
5 x 6	14.5	2.1
5 x 10	18	3.24
5 x 16	21.5	4.62
5 x 25	26	6.76
7 x 1.5	10.5	1.1
7 x 2.5	13	1.69

Insulated power cables

Type	Diameter mm	Usable cross-section cm ²
1 x 10	10.5	1.1
1 x 16	11.5	1.32
1 x 25	12.5	1.56
1 x 35	13.5	1.82
1 x 50	15.5	2.4
1 x 70	16.5	2.72
1 x 95	18.5	3.42
1 x 120	20.5	4.2
1 x 150	22.5	5.06
1 x 185	25	6.25
1 x 240	28	7.84
1 x 300	30	9
3 x 1.5	11.5	1.32
3 x 2.5	12.5	1.56
3 x 10	17.5	3.06
3 x 16	19.5	3.8
3 x 50	26	6.76
3 x 70	30	9
3 x 120	36	12.96
4 x 1.5	12.5	1.56
4 x 2.5	13.5	1.82
4 x 6	16.5	2.72
4 x 10	18.5	3.42
4 x 16	21.5	4.62
4 x 25	25.5	6.5
4 x 35	28	7.84
4 x 50	30	9
4 x 70	34	11.56
4 x 95	39	15.21
4 x 120	42	17.64
4 x 150	47	22
4 x 185	52	27
4 x 240	58	33.6
5 x 1.5	13.5	1.82
5 x 2.5	14.5	2.1
5 x 6	18.5	3.42
5 x 10	20.5	4.2
5 x 16	22.5	5.06
5 x 25	27.5	7.56
5 x 35	34	11.56
5 x 50	40	16

Telecommunications cables

Type	Diameter mm	Usable cross-section cm ²
2 x 2 x 0.6	5	0.25
4 x 2 x 0.6	5.5	0.3
6 x 2 x 0.6	6.5	0.42
10 x 2 x 0.6	7.5	0.56
20 x 2 x 0.6	9	0.81
40 x 2 x 0.6	11	1.12
60 x 2 x 0.6	13	1.69
100 x 2 x 0.6	17	2.89
200 x 2 x 0.6	23	5.29
2 x 2 x 0.8	6	0.36
4 x 2 x 0.8	7	0.49
6 x 2 x 0.8	8.5	0.72
10 x 2 x 0.8	9.5	0.9
20 x 2 x 0.8	13	1.69
40 x 2 x 0.8	16.5	2.72
60 x 2 x 0.8	20	4
100 x 2 x 0.8	25.5	6.5
200 x 2 x 0.8	32	10.24



Coax cable (Standard)

Type	Diameter mm	Usable cross-section cm ²
SAT/BK cable	6.8	0.48



IT cables type Cat...

Type	Diameter mm	Usable cross-section cm ²
Cat. 5	8	0.64
Cat. 6	8	0.64



How can I find a system of the appropriate volume?



Cable height

The cable height may not exceed the edge height of the cable tray.



Volume reserve

When selecting the system, a volume reserve of at least 30% should be planned for possible later installations.



Branches

When dimensioning branches, the bending radii of the cables must be taken into account.



Separation of system levels

When selecting the volume, pay attention to the different conductors. To separate different voltage levels, you must take the required spacings into account.



Same usable cross-section, different requirements

The following table will help you to choose a cable support system of the right volume. It underlines the interplay of tray or ladder width, slant height and usable cross-section. The difference when laying the same volume of data and power cables should be taken into account: while it is possible to select a narrow, high tray for data cables, a wide, flat tray is necessary for power cables.



Examples

Flat, wide variant:

- e.g. for power cables
- Cable tray width: 300 mm
- Side rail height: 35 mm
- Usable cross-section: 103 cm²

Narrow, high variant:

- e.g. for data cables
- Cable tray width: 100 mm
- Side height: 110 mm
- Usable cross-section: 108 cm²



Reference laying types



When selecting the correct system, also observe the current DIN/VDE standards (0298 T1 to T4). They provide information on the heating of conductors, depending on the amassment and the ambient temperature.



Reference laying type: C
Cable on unperforated cable tray, e.g. type MKSMU



Reference laying type: E or F
Cable on perforated cable tray, horizontal/vertical, e.g. type RKSM/MKSM



Reference laying type: E, F or G
Cable or installation cable on mesh cable trays, e.g. type GR-Magic®



How do I calculate the cable weight?



100 mm = 15 kg/m



200 mm = 30 kg/m



300 mm = 45 kg/m



400 mm = 60 kg/m



500 mm = 75 kg/m



600 mm = 90 kg/m

Of equal significance for the selection of the most suitable cable support system is the load capacity. This must be matched with the expected cable weight (including the reserve for later installation). There are three variants for determining the cable weight:

Variant 1: Orientation to experience values

The average load capacity of a cable tray can be calculated roughly using experience values. For a system with a strut height of 60 mm, a value of 15 kg per 100 mm width is valid for each metre of cable tray or cable ladder. However, more accurate than orientation to experience values is to calculate the cable load using the formula from DIN VDE 0639 Part 1 (Variant 2) or the manufacturer's specifications (Variant 3). The graphics show the load capacities, based on experience values, of cable trays with a rail height of 60 mm, relative to cable tray widths of 100 to 600 mm.

Variant 2: Calculation formula according to VDE 0639 T1

DIN VDE 0639 Part 1 (cable support systems) offers a formula for calculating the maximum permitted cable load. In the example calculation below, the maximum approved cable load for a cable tray is worked out using the dimension 60 x 300 mm and a usable cross-section of 178 cm².

Variant 3: Exact calculation according to manufacturer's specifications

Most cable manufacturers offer a very accurate method of calculating cable weights, and appropriate lists or tables can be obtained from them. Important: The following tables only provide a rough overview. They are average values, which may vary from manufacturer to manufacturer. Please refer to the manufacturer's specifications for the exact values.

	0.028 N	
Cable load (F) =	_____	x Usable cross-section
	m x mm ²	

	0.028 N	
1. Cable load (F) =	_____	x 17,800 mm² = 500 N/m
	m x mm ²	

2. Conversion from Newtons (N) to kilogrammes (kg)
10 N ~ 1 kg – in our example, this means: 500 N/m = 50 kg/m

3. Maximum occurring load = 50 kg/m



Actual cable load of different cable types



Insulated power cables

Type	Cable load kg/m
1 x 4	0.08
1 x 6	0.105
1 x 10	0.155
1 x 16	0.23
1 x 25	0.33
3 x 1.5	0.135
3 x 2.5	0.19
3 x 4	0.265
4 x 1.5	0.16
4 x 2.5	0.23
4 x 4	0.33
4 x 6	0.46
4 x 10	0.69
4 x 16	1.09
4 x 25	1.64
4 x 35	2.09
5 x 1.5	0.19
5 x 2.5	0.27
5 x 4	0.41
5 x 6	0.54
5 x 10	0.85
5 x 16	1.35
5 x 25	1.99
7 x 1.5	0.235
7 x 2.5	0.35

Insulated power cables

Type	Cable load kg/m
1 x 10	0.18
1 x 16	0.24
1 x 25	0.35
1 x 35	0.46
1 x 50	0.6
1 x 70	0.8
1 x 95	1.1
1 x 120	1.35
1 x 150	1.65
1 x 185	2
1 x 240	2.6
1 x 300	3.2
3 x 1.5	0.19
3 x 2.5	0.24
3 x 10	0.58
3 x 16	0.81
3 x 50	1.8
3 x 70	2.4
3 x 120	4
4 x 1.5	0.22
4 x 2.5	0.29
4 x 6	0.4
4 x 16	1.05
4 x 25	1.6
4 x 35	1.75
4 x 50	2.3
4 x 70	3.1
4 x 95	4.2
4 x 120	5.2
4 x 150	6.4
4 x 185	8.05
4 x 240	11
5 x 1.5	0.27
5 x 2.5	0.35
5 x 6	0.61
5 x 10	0.88
5 x 16	1.25
5 x 25	1.95
5 x 35	2.4
5 x 50	3.5

Telecommunications cables

Type	Cable load kg/m
2 x 2 x 0.6	0.03
4 x 2 x 0.6	0.035
6 x 2 x 0.6	0.05
10 x 2 x 0.6	0.065
20 x 2 x 0.6	0.11
40 x 2 x 0.6	0.2
60 x 2 x 0.6	0.275
100 x 2 x 0.6	0.445
200 x 2 x 0.6	0.87
2 x 2 x 0.8	0.04
4 x 2 x 0.8	0.055
6 x 2 x 0.8	0.08
10 x 2 x 0.8	0.115
20 x 2 x 0.8	0.205
40 x 2 x 0.8	0.38
60 x 2 x 0.8	0.54
100 x 2 x 0.8	0.875
200 x 2 x 0.8	1.79



Coax cable (standard)

Type	Cable load kg/m
SAT/BK cable	0.06



IT cables type Cat...

Type	Cable load kg/m
Cat. 5	0.06
Cat. 6	0.06

Which trays and ladders can support which cable load?

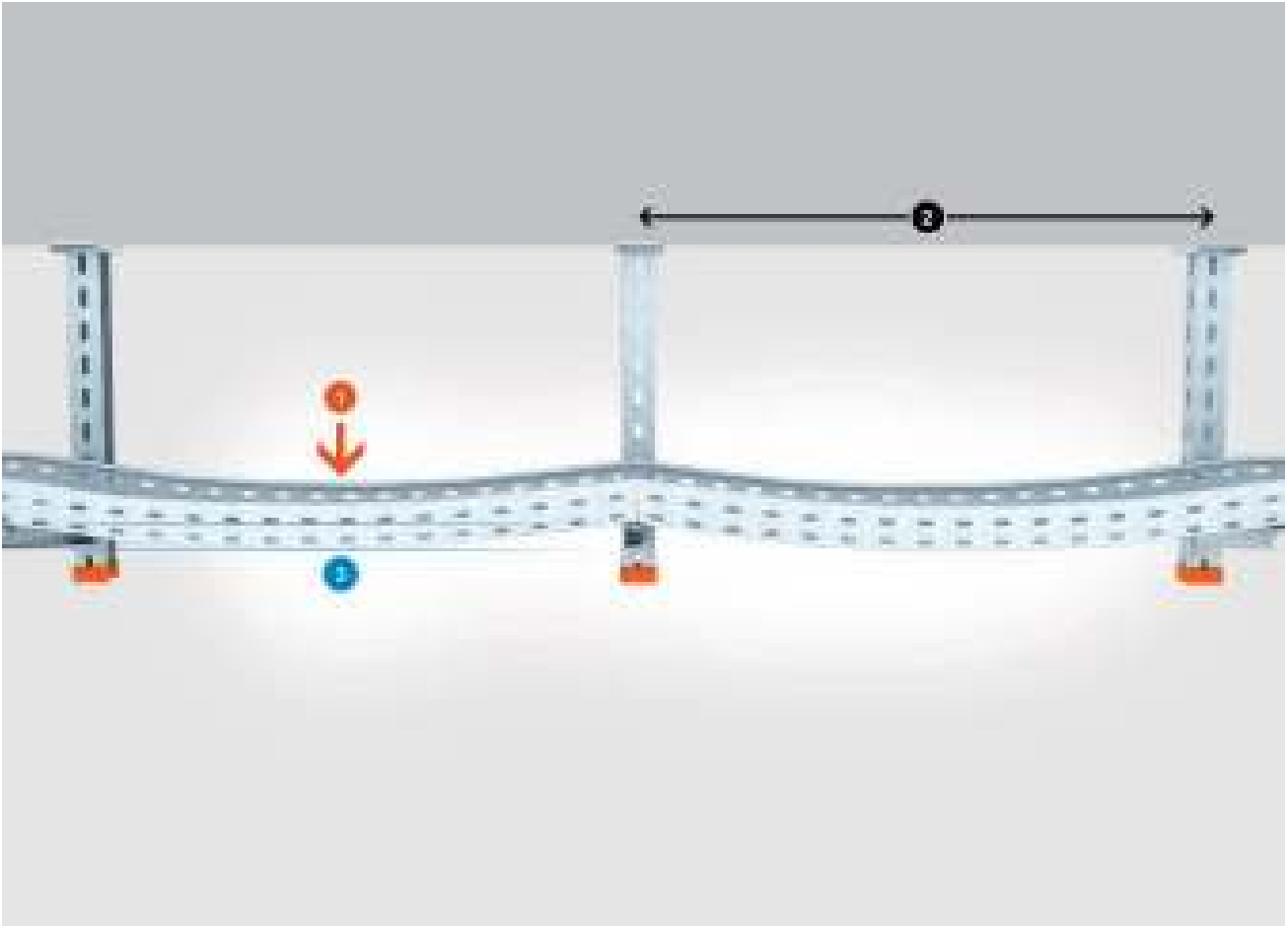

Explanation of the pictograms: 1 = load in kN without man load, 2 = support width in m, 3 = strut bend in mm

Load tests for cable support systems

All OBO products and systems are subjected to practical load testing. The basic principles for the tests of OBO cable support systems are DIN EN 61537 and DIN VDE 0639. After the load test, the maximum load capacity can be determined for each component, depending on the support distances and specific article parameters, such as component dimensions. This is all shown in a chart, included with each component.

You can find additional information on the load tests for cable trays, brackets and suspended supports on the following pages. The values given do not take resistance against environmental forces such as snow, wind and other outside influences into account.

Which trays and ladders can support which cable load?

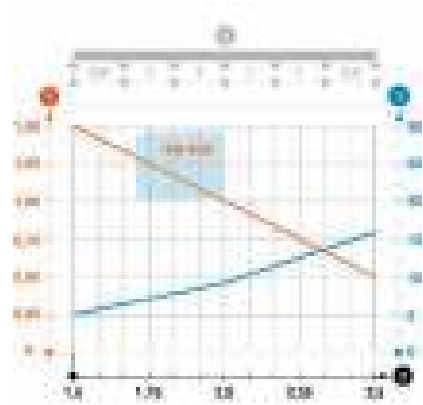
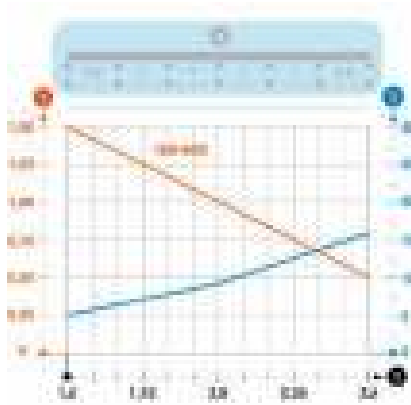
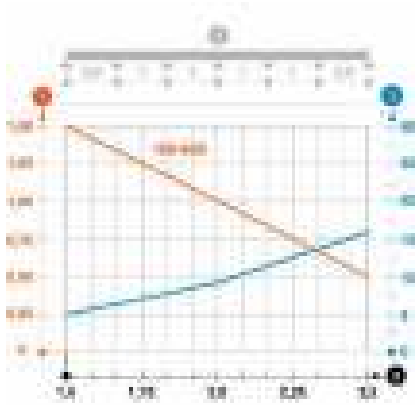

Load diagram, legend

- 1 = Load in kN/m
without human load
- 2 = Support width in m
- 3 = Strut bending in mm
- 4 = Schematic diagram
of the support widths during
the testing process
- = Approved load according to
the support widths for the different
tray widths
- = Rail bending according to sup-
port width

Information 1: The testing process

The basic principles of the tests of OBO cable support systems is VDE 0639 Part 1 and DIN EN 61537. The purpose of the tests is to determine the maximum load capacities for each component, depending on parameters such as component width, support spacing, etc., and to present this in a diagram to be included with each component. The area highlighted in blue in the above example schematises the experiment set-up with a variable support spacing (L) in the central area and a factor of $0.8 \times L$ at the front and rear ends of the cable tray.

Information 2: Load curves for selected cable tray or cable ladder widths

The load capacity of the cable trays according to the support width can be read off in the diagram using the load curves – this is an example for a cable tray for the tray widths 100 to 600 mm. It may occur that in the load curves, width differences must be made, allowing multiple curves to be visible simultaneously in the diagram. A key factor for the load capacity of the cable trays is (in addition to the support spacing and side height) the material thickness, which varies according to type.



Which trays and ladders can support which cable load?

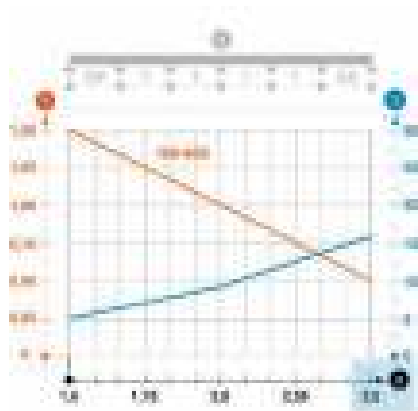

Information 3: Possible support spacings

The theoretically possible spans for the cable tray can be read off on the axis at the foot of the table. Using the load curves, it is easy to read off to what extent the load capacity of the system falls as the support spacing grows. On all OBO cable support systems (with the exception of the wide span trays), we recommend not exceeding a support spacing of 1.5 m, if possible.

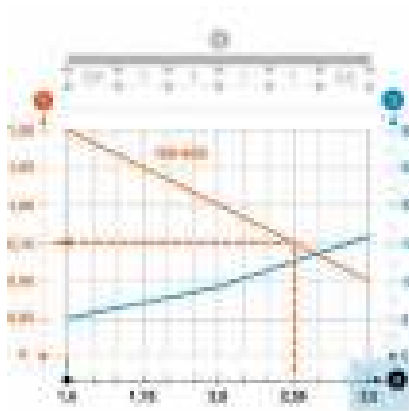

Information 4: Ratio: load/span

Which load is possible at which support spacing? With the diagram, you can find the appropriate information at a glance. In our example (with the blue background), a span of 2.25 m for the tray produces a maximum load capacity of 0.75 kN for each running metre of cable tray. Please note that in this example, the volume of the cable tray may exceed the permitted load. Therefore if at all possible, do not exceed the support spacing of 1.5 m, as recommended by OBO.

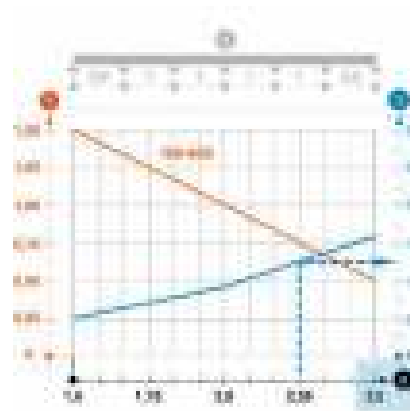

Information 5: W = Rail bending

To what extent does the load on a cable tray cause the rail to bend? This information is supplied by the blue curve (w) in millimetres (orientation values on the axis on the right-hand side of the diagram).

The course of the blue curve clearly shows how quickly the cable tray will sag as the support spacing increases. In our example, the bend at a support spacing of 2.25 m is shown, here approximately 12 mm.

Which bracket can support which cable load?

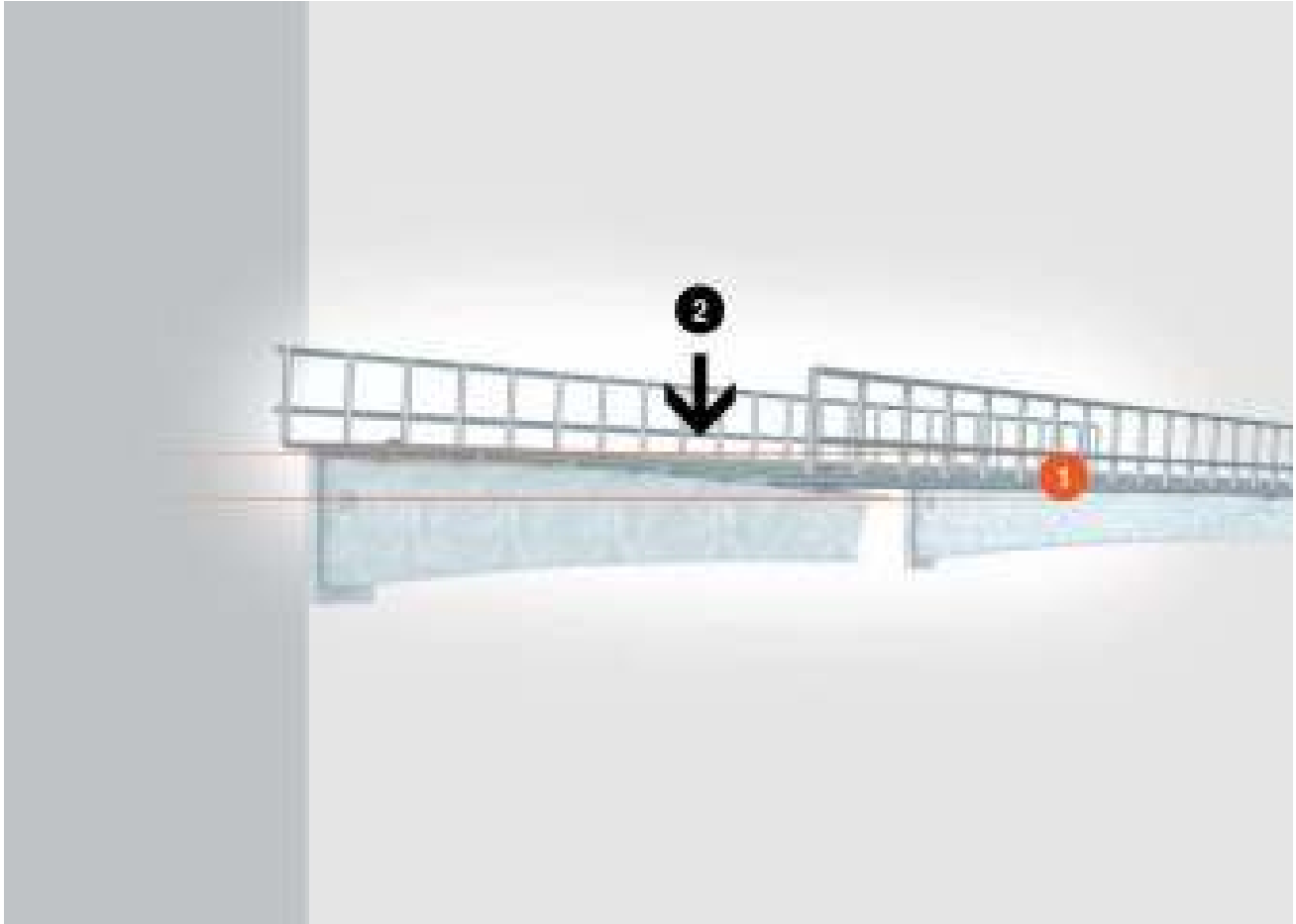

Key components of the OBO cable support systems are the installation components, in particular the brackets and suspended supports. They connect the cable trays and ladders to the wall and to the ceiling, and are thus an important construction element of the overall system. When calculating the load capacity of a cable support system, the brackets and suspended supports must not be forgotten. The test diagram is also useful in selecting the right products.

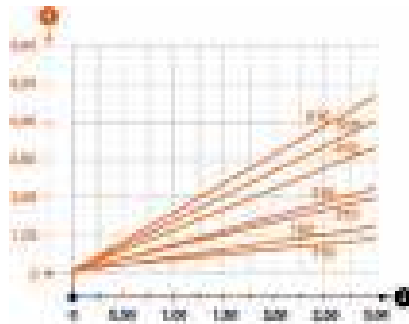

Load diagram, legend

- 1 = Bend in mm at the bracket tip
- 2 = Load without man load in kN/m
- = Load curves for the different bracket lengths



Which bracket can support which cable load?

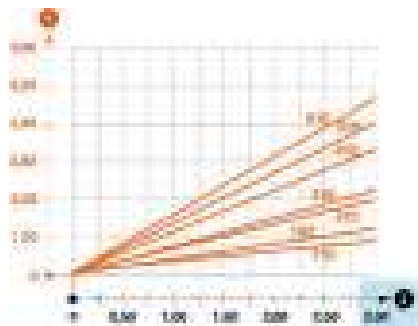

Information 1: Recommended maximum load of the brackets

The bracket is the part of the installation system upon which the cable tray or mesh cable tray is located. It is either directly connected to the wall or is connected to the ceiling using supports. The grey bar on the right edge of the diagram provides information on the maximum load capacity of the bracket.

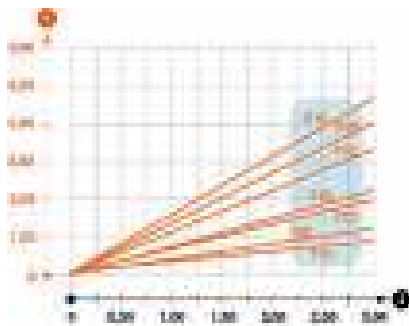

Information 2: Load curves for all bracket widths

The bending of the bracket is dependent on its width, which in our example, can range from 110 mm to 610 mm. The load curves are assigned to the appropriate bracket type.

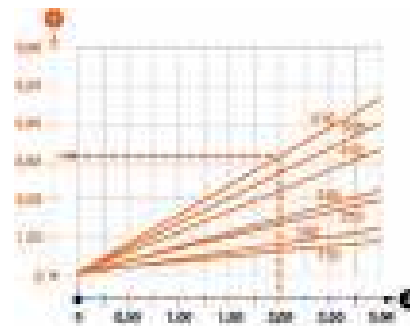

Information 3: Bending of the bracket tip at a specific load

The load curve in the diagram provides information on the bending of the boom tip at a specific load. In our example (dotted orange line), a 610 mm-wide bracket with a load of 2 kN bends by approx. 3.1 mm. A basic rule of thumb is: The shorter the bracket, the less the bend will be.

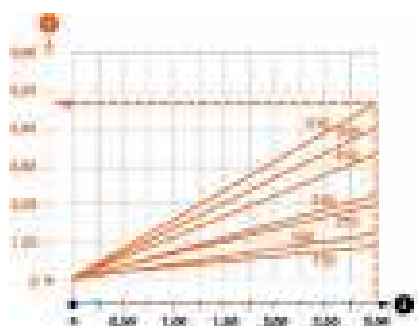

Information 4: Bending of the bracket tip at maximum load

The bending factor of the bracket at maximum load can also be seen in the diagram. In our example (shown in orange), the bend value for a 610 mm-wide bracket at a maximum load of approx. 3.0 kN is approximately 4.5 mm. To minimise the bend, the centre of gravity of the cable load should be as close as possible to the wall or the support fastening.

Which support can support which cable load?

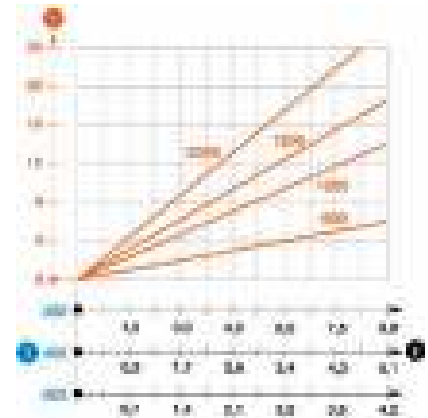

Load diagram, legend

- 1 = Bend in mm at the bracket tip
- 2 = Load without man load in kN/m
- = Load curves for the different bracket lengths

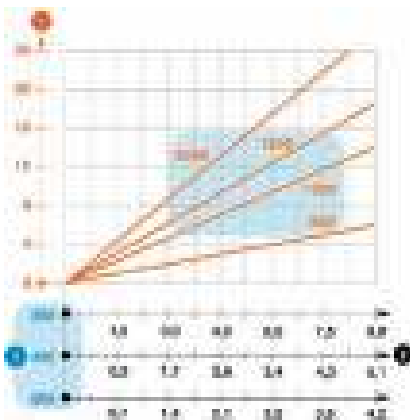

Information 1: Various support lengths and bracket widths

The load capacity of a cable support system is not just dependent on the width of a bracket, but also on the length of a suspended support. The load curves in the diagram provide information on the load capacity of a suspended support of length 600, 1,000, 1,500 or 2,000 mm, taking the bracket width into account.

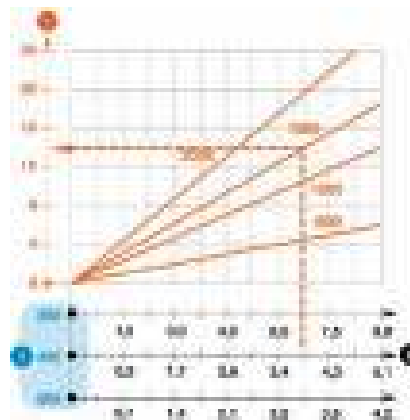

Information 2: Calculation of the deflection for the example

The weight of the total suspended support/bracket/cable tray system causes an excursion of the suspended support from the vertical. The excursion value can be read off from the axis on the left edge of the diagram. In our example (blue background), a 1,500 mm-long suspended support, together with a 400 mm-wide bracket and a weight load of 4 kN at the end of the support, will produce an excursion of approximately 14 mm.

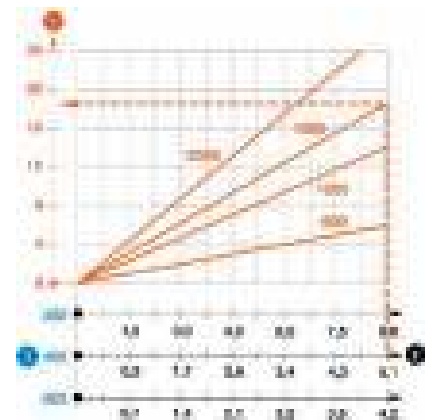

Information 3: Calculation of the excursion at maximum load for the example

The excursion of the suspended support at a maximum load can also be read off on the diagram. Our blue example shows an excursion of roughly 18 mm at the end of the support for a 1,500 mm-long suspended support, in combination with a 400 mm-wide bracket at a maximum cable load of approximately 5 kN.















Test marks

	Verband der Elektrotechnik, Elektronik, Informationstechnik e.V., Germany
	FIMKO, Finland
	KEMA-KEUR, Netherlands
	Österreichischer Verband für Elektrotechnik, Austria
	Eidgenössisches Starkstrominspektorat, Switzerland
	NEMKO, Norway
	SEMKO An Inchcape Testing Services Company, Sweden
	Indication of metric products
	DEMKO, Danmarks Elektriske Materielkontrol, Denmark
	Sähkötarkastuskeskus Elinspektionscentralen Electrical Inspectorate, Finland
	Underwriters Laboratories Inc., USA
	Underwriters Laboratories Inc., USA
	Canadian Standards Association, Canada
	CEBEC, Belgium
	STOWARZYSZENIE ELEKTRYKÓW POLSKICH, Poland
	Forschungs- und Materialprüfungsanstalt, Germany
	Shock-tested, Bundesamt für Zivilschutz, Germany
	MAGYAR ELEKTROTECHNIKAI ELLENŐRZŐ INTÉZET Budapest, Hungary
DIBt	Deutsches Institut für Bautechnik Berlin, Germany
	ELEKTROTECHNICKÝ ZKUŠEBNÍ ÚSTAV, Czech Republic
	Test marks for technical resources, VDE Prüf- und Zertifizierungsinstitut Offenbach, Germany
	RINA 1861, Ship Classification, Certification and Services
	American Bureau of Shipping, USA





Pictogram explanation

Materials

	Aluminium
	Aluminium/steel
	Stainless steel, rustproof 1.4113
	Stainless steel, rustproof 1.4301
	Stainless steel, rustproof 1.4303
	Stainless steel, rustproof 1.4310
	Stainless steel, rustproof 1.4401
	Stainless steel, rustproof 1.4404
	Stainless steel, rustproof 1.4435
	Stainless steel, rustproof 1.4529
	Stainless steel, rustproof 1.4571
	Stainless steel, rustproof
	Stainless steel, rustproof
	Stainless steel, rustproof
	Steel

Surfaces

	Hot-dip galvanised
	Electrogalvanised, yellow-chromated
	Strip galvanised zinc/aluminium, double dip
	Strip galvanised
	Electrogalvanised
	Primed
	Hot-dip galvanised
	Zinc-aluminium coated, Galfan
	Welding primed
	Zinc scale

CR — Chloroprene rubber

Temperature resistance:
permanently up to 120 °C, briefly up to approx. 150 °C and to approx. minus 30 °C*.

Resistant to
Oils and acids.
Unstable with
Fuels.

FA — Fibre-proof material DIN 28091

To DIN 28091, asbestos-free
Temperature resistance:
up to 300 °C.

GFK — Fibre-glass-reinforced plastic

Temperature resistance:
minus 50 to 130 °C.

Resistant to
High chemical resistance
Corrosion resistance
UV light resistance

NR — Natural rubber

Temperature resistance:
permanently up to 80 °C, briefly up to approx. 120 °C and to approx. minus 40 °C*.

Resistant to
Most acids.
Unstable with
Fuels, solvents, oils.

PA — Polyamide

Temperature resistance:
permanently up to approx. 90 °C, briefly up to about 130 °C
and to about minus 40 °C*.
Chem. resistance generally as for polyethylene.

Resistant to
Petrol, benzene, diesel oil, acetone, solvents for paints and lacquers, oils and greases.
Unstable with
Bleach, most acids, chlorine.
Risk of stress cracks
Low in air-humid conditions; only with some aqueous salt solutions. Highly desiccated parts (high temperature and extremely low air humidity) are highly sensitive to fuels and various solvents.

PA/GF — Polyamide, fibre-glass reinforced

Temperature resistance:
permanently up to 100–110 °C, briefly up to 160 °C
and to about minus 40 °C*.

Resistant to
Petrol, benzene, diesel oil, acetone, solvents for paints and lacquers, oils and greases.
Slightly susceptible to stress-cracking.
Unstable with
Bleach, most acids, chlorine.
Risk of stress cracks
Low in air-humid conditions; only with some aqueous salt solutions. Highly desiccated parts (high temperature and extremely low air humidity) are highly sensitive to fuels and various solvents.

PC — Polycarbonate

Temperature resistance:
permanently up to approx. 110 °C (in water 60 °C), briefly up to 125 °C, and to below minus 35 °C.

Resistant to
Petrol, turpentine, most weak acids.
Unstable with
Acetone, benzene, chlorine, methylene chloride, most concentrated acids.
Risk of stress cracks
Relatively low.
Media which can cause tension cracking include benzene, aromatic hydrocarbons, methanol, butanol, acetone, turpentine.

POM — Polyacetal (polyoxymethylene, polyformaldehyde)

Temperature resistance:
permanently up to approx. 100 °C, briefly up to approx. 130 °C and to approx. minus 40 °C.

Resistant to
Acetone, ether, petrol, weak acetic acid, benzene, heating oil, oils and greases, toluene.
Unstable with
Methylene chloride, trichloroethylene, hydrochloric acid, nitric acid, sulphuric acid.
Risk of stress cracks
Low.

PE — Polyethylene

Temperature resistance:
hard types permanently up to about 90 °C, briefly up to about 105 °C, soft types permanently up to about 80 °C, briefly up to about 100 °C and to about minus 40 °C*.

Resistant to
Alkalis and inorganic acids.
Conditionally resistant to
Acetone, organic acids, petrol, benzene, diesel oil, most oils.
Unstable with
Chlorine, hydrocarbons, oxidising acids.
Risk of stress cracks
Relatively high.
Stress cracks can be caused by, among other things, acetone, various alcohols, formic acid, ethanol, petrol, benzene, butyric acid, acetic acid, formaldehyde, various oils, petroleum, propanol, nitric acid, hydrochloric acid, sulphuric acid, soap solutions, turpentine, trichloroethylene, citric acid.

PBPT — Polybutylene terephthalate

Thermoplastic polyester
Temperature resistance:
permanently up to 120 °C, briefly up to 140 °C and to approx. minus 40 °C.
Resistant to
Petrol, diesel oil, most weak acids, oils and greases.
Conditionally resistant to
Acetone, ammonia, benzene.
Unstable with
Strong acids, chlorine, fluorine, bromine vapour, bleach, trichloroethylene, methylene chloride.
Risk of stress cracks
Low.

PS — Polystyrene

Temperature resistance:
Because of its relatively high sensitivity to the effects of chemicals, its use is not recommended at temperatures above normal room temperature, about 25 °C.
Resistance to cold: to about minus 40 °C*.
Resistant to
Alkalis, most acids, alcohol.
Conditionally resistant to
Oils and greases.
Unstable with
Butyric acid, concentrated nitric acid, concentrated acetic acid, acetone, ether, petrol and benzene, solvents for paints and lacquers, chlorine, diesel fuel.
Risk of stress cracks
Relatively high.
Stress cracks can be caused by, amongst other things, acetone, ether, petrol, cyclohexane, heptane, methanol, propanol and the softeners used in some PVC cable mixes.

PVC — Polyvinylchloride

Temperature resistance:
permanently up to 65 °C, briefly up to 75 °C and to approx. minus 30 °C*.
Resistant to
Weak acids, alkalis, oils and greases, petrol.
Unstable with
Strong acids, benzene, acetone, iodine, toluene, trichloroethylene.
Risk of stress cracks
Low, only with some solvents such as benzene and acetone.

Plastic materials

SBR — Styrene-butadiene rubber

Temperature resistance:
permanently up to 80 °C, briefly up to approx. 120 °C and to approx.
minus 30 °C*.

Resistant to

Most acids.

Unstable with



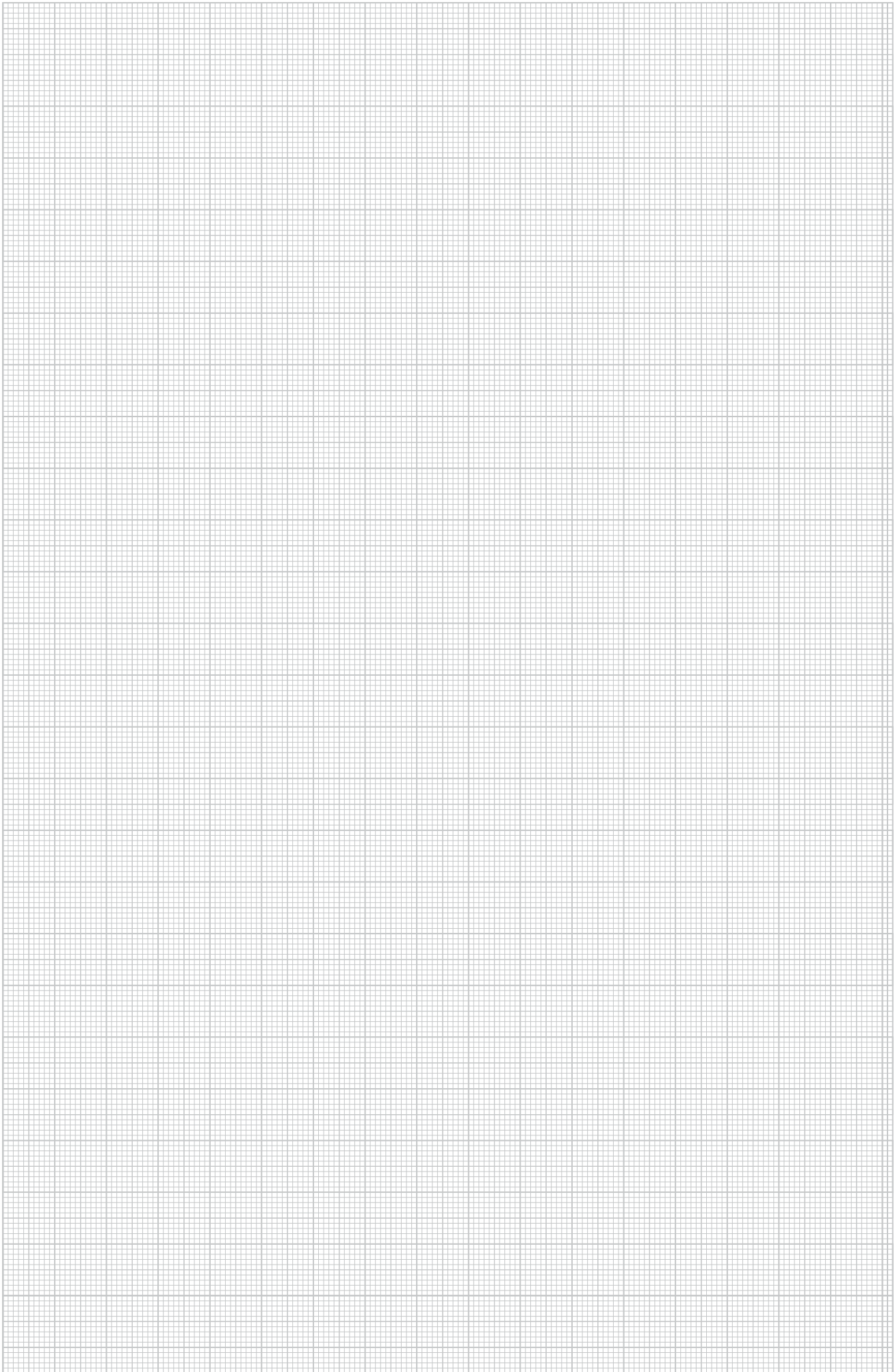

Fuels, solvents, oils.







Mounting systems

	Universal systems	44
	U support systems	45
	Wall, support and clamping brackets	56
	Clamp fastening systems	61
	Construction and profile rail systems	62



Threaded rod

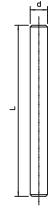

Type	Thread	Dim. d mm	Dim. L mm	Pack Piece	Weight kg/100 pc.	Item no.
TR M8 1M G	M8	8	1000	10	30.000	3141128
TR M10 1M G	M10	10	1000	10	49.000	3141209
TR M12 1M G	M12	12	1000	10	62.000	3141306

Threaded rod to DIN 976.

Connection sleeve

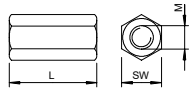

Type	Thread	Dim. L mm	SW mm	Pack Piece	Weight kg/100 pc.	Item no.
CSTR M8 G	M8	24	13	50	1.880	6410081
CSTR M10 G	M10	30	17	50	4.150	6410103
CSTR M12 G	M12	40	19	25	7.000	6410111

Connection sleeve with continuous internal thread.

Stand-off bracket

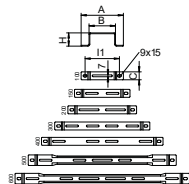

Type	Dim. A mm	Dim. B mm	Dim. H mm	Pack Piece	Weight kg/100 pc.	Item no.
DBL 50 100 FS	160	100	50	20	15.500	6015506
DBL 50 150 FS	210	150	50	20	18.800	6015514
DBL 50 200 FS	260	200	50	20	21.000	6015522
DBL 50 300 FS	360	300	50	20	36.900	6015530
DBL 50 400 FS	460	400	50	20	46.300	6015549
DBL 50 500 FS	560	500	50	25	57.200	6015552
DBL 50 600 FS	660	600	50	20	65.800	6015555
DBL 50 100 FT	160	100	50	20	16.000	6015565
DBL 50 150 FT	210	150	50	20	19.400	6015573
DBL 50 200 FT	260	200	50	20	22.000	6015581
DBL 50 300 FT	360	300	50	20	38.000	6015603
DBL 50 400 FT	460	400	50	20	47.700	6015611
DBL 50 500 FT	560	500	50	25	58.900	6015614
DBL 50 600 FT	660	600	50	20	67.800	6015617

Stand-off bracket for cable trays and mesh cable trays.

US 3 support

Type	Length mm	Material thickness mm	Tensile load kN	Pack Piece	Weight kg/100 pc.	Item no.
US 3 K 20 FT	200	2	5	1	50.500	6342351
US 3 K 30 FT	300	2	5	1	64.400	6342353
US 3 K 40 FT	400	2	5	1	78.300	6342355
US 3 K 50 FT	500	2	5	1	92.300	6342357
US 3 K 60 FT	600	2	5	1	106.200	6342359
US 3 K 70 FT	700	2	5	1	120.200	6342362
US 3 K 80 FT	800	2	5	1	134.100	6342364
US 3 K 90 FT	900	2	5	1	147.800	6342366
US 3 K 100 FT	1000	2	5	1	162.000	6342368
US 3 K 110 FT	1100	2	5	1	175.900	6342370
US 3 K 120 FT	1200	2	5	1	189.900	6342372

For fastening to horizontal concrete ceilings and steel girders. For bracket widths of 400 mm or more, or if the bracket is mounted at the end of a suspended support, we recommend the use of the spacer, type DSK 25.

Suspended support (U profile) of dimensions 50 x 30 mm with welded head plate.

Load diagram, U support, type US 3 K

- 1 Bending of the end of the suspended support at permitted bracket load
 - 2 Permitted bracket load in kN without man load
 - 3 Bracket length in mm
- Load curves with support lengths in mm

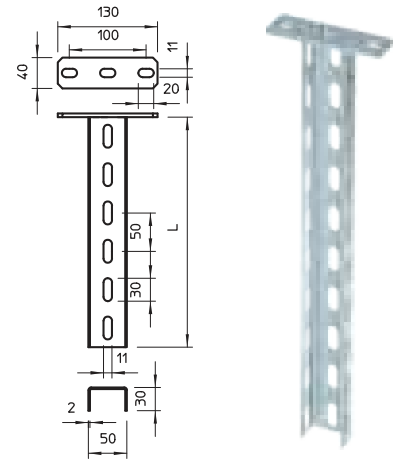

Characteristic anchor load values for US 3 K suspended support

Single-sided load				
Anchor type	Max. load F [kN]			
	Bracket width [mm]			
	110	210	310	410
BZ-U 8-10-21/75	2,00	1,50	1,15	0,90
BZ-U 10-10-30/90	3,50	2,70	2,00	1,75

Double-sided load				
Anchor type	Max. load F [kN]			
	Bracket width [mm]			
	110	210	310	410
BZ-U 8-10-21/75	1,30	3,25	2,80	1,50
BZ-U 10-10-30/90	6,00	5,80	5,00	4,50

Max. total load F = cable weight + cable tray + bracket + support. The tabular values for double-sided loads take the available axis spacing $a_i = 10$ cm into account. The load capacity values increase considerably when used in uncracked concrete. The values given are based on concrete of strength class C20/25. Observe the installation conditions of the DIBt approval (anchors).

Load

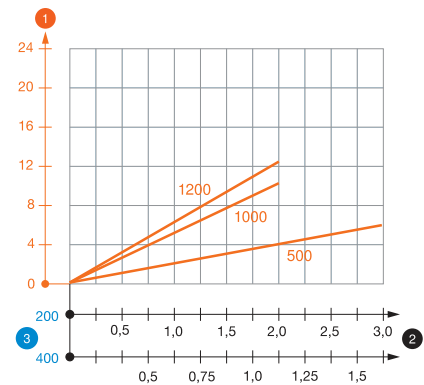

US 3 support

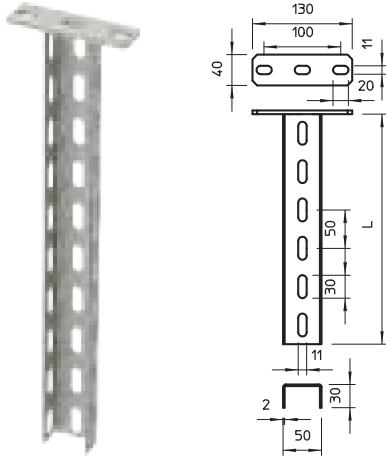

Type	Length mm	Material thickness mm	Tensile load kN	Pack Piece	Weight kg/100 pc.	Item no.
US 3 K 20 A2	200	2	5	1	44.000	6342401
US 3 K 30 A2	300	2	5	1	58.000	6342403
US 3 K 40 A2	400	2	5	1	71.000	6342405
US 3 K 50 A2	500	2	5	1	84.000	6342407
US 3 K 60 A2	600	2	5	1	97.000	6342409
US 3 K 70 A2	700	2	5	1	110.000	6342411
US 3 K 80 A2	800	2	5	1	123.000	6342413
US 3 K 90 A2	900	2	5	1	137.000	6342415
US 3 K 100 A2	1000	2	5	1	150.000	6342417

Suspended support (U profile) of dimensions 50 x 30 mm with welded head plate.

Load

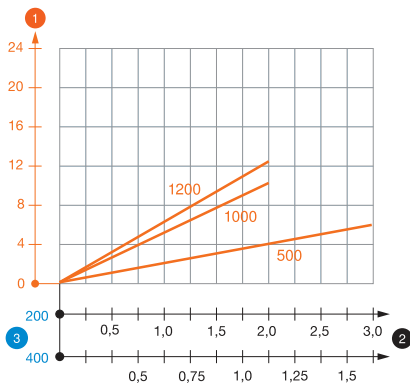

Load diagram, U support, type US 3 K

- 1 Bending of the end of the suspended support at permitted bracket load
 - 2 Permitted bracket load in kN without man load
 - 3 Bracket length in mm
- Load curves with support lengths in mm

Characteristic anchor load values for US 3 K suspended support

Single-sided load				
Anchor type	Max. load F [kN]			
	Bracket width [mm]			
	110	210	310	410
BZ-U 8-10/75	2,00	1,50	1,15	0,90
BZ-U 10-10/90	3,50	2,70	2,00	1,75

Double-sided load				
Anchor type	Max. load F [kN]			
	Bracket width [mm]			
	110	210	310	410
BZ-U 8-10/75	1,30	3,25	2,80	1,50
BZ-U 10-10/90	6,00	5,80	5,00	4,50

Max. total load F = cable weight + cable tray + bracket + suspended support. The tabular values for double-sided loads take the available axis spacing $a_i = 10$ cm into account. The load capacity values increase considerably when used in uncracked concrete. The specified values are based on concrete of resistance class C20/25. Comply with the installation conditions of the DIBt approval (anchors).

US 3 support

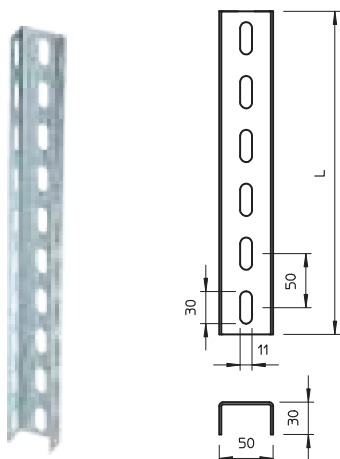

Type	Length mm	Material thickness mm	Pack Piece	Weight kg/100 pc.	Item no.
US 3 20 FS	200	2	1	27.000	6342302
US 3 30 FS	300	2	1	40.000	6342304
US 3 40 FS	400	2	1	53.000	6342306
US 3 50 FS	500	2	1	67.000	6342308
US 3 60 FS	600	2	1	80.000	6342310
US 3 70 FS	700	2	1	93.000	6342312
US 3 80 FS	800	2	1	107.000	6342314
US 3 90 FS	900	2	1	120.000	6342316
US 3 100 FS	1000	2	1	133.000	6342318
US 3 150 FS	1500	2	1	200.000	6342328
US 3 200 FS	2000	2	1	266.000	6342338
US 3 300 FS	3000	2	1	399.000	6342340
US 3 30 A2	300	2	1	42.200	6342455
US 3 50 A2	500	2	1	66.000	6342457
US 3 100 A2	1000	2	1	132.000	6342460
US 3 150 A2	1500	2	1	198.000	6342463
US 3 200 A2	2000	2	1	263.000	6342466

For bracket widths of 400 mm or more, or if the bracket is mounted at the end of a suspended support, we recommend the use of the spacer, type DSK 25.

U support in fixed lengths. Dimensions 30 x 50 mm.

Protective cap

Type	Colour	Pack Piece	Weight kg/100 pc.	Item no.
US 3 KS OR	Pastel orange	20	1.068	6338458

Protective cap to cover the ends of US 3 supports.

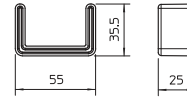

VUS 3 U support connector

Type	Pack Piece	Weight kg/100 pc.	Item no.
VUS 3 FT	10	48.300	6018513
VUS 3 A2	1	48.200	6018517

Including appropriate fastening material.

U support connector to connect US 3 supports.

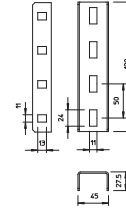

DSK 25 spacer

Type	Pack Piece	Weight kg/100 pc.	Item no.
DSK 25 A2	10	7.500	6416448
DSK 25 FT	20	7.500	6416446

Spacer for use in US 3 supports.

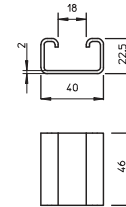

Truss-head bolt with nut and washer

Type	Dimension mm	Dim. L mm	Dim. d mm	Dim. D mm	Resistance grade	Pack Piece	Weight kg/100 pc.	Item no.
FRS 10x25 F 8.8	M 10 x 25	25	10	24	8.8	50	4.500	6407560

The truss-head bolt can be used in combination with hot-dip and double-dip galvanised articles. Truss-head bolt with square neck. With washer and hexagonal nut.

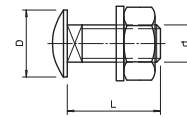

Hexagonal bolt with nut and washer

Type	Dimension mm	Dim. L mm	Dim. d mm	Dim. SW mm	Resistance grade	Pack Piece	Weight kg/100 pc.	Item no.
SKS 10x80 F	M 10 x 80	80	10	17	8.8	20	6.865	6418250

Hexagonal bolt for universal fixing of structure components.

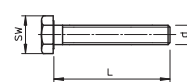

Hexagonal bolt with nut and washer

Type	Dimension mm	Dim. L mm	Dim. d mm	Dim. SW mm	Resistance grade	Pack Piece	Weight kg/100 pc.	Item no.
SKS 10x80 A4	M 10 x 80	80	10	17	A4-70	20	7.800	6418248

Hexagonal bolt for universal fixing of structure components.

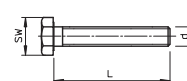

U support system US 3

Head plate

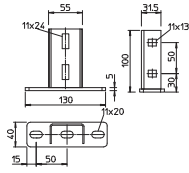

Type
KU 3 FT

Pack Piece	Weight kg/100 pc.	Item no.
10	42.300	6348874

The head plate can be mounted to fixed lengths of the U support, type US 3.
Including appropriate fastening material.
Head plate for mounting on US 3 supports.

Head plate

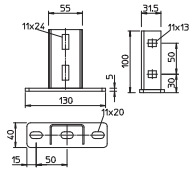

Type
KU 3 A2

Pack Piece	Weight kg/100 pc.	Item no.
10	41.000	6348876

The head plate can be mounted to fixed lengths of the U support, type US 3.
Including appropriate fastening material.
Head plate for mounting on US 3 supports.

US 5 support



Type	Length mm	Material thickness mm	Tensile load kN	Pack Piece	Weight kg/100 pc.	Item no.
US 5 K 20 FT	200	2.5	10	1	85.000	6341527
US 5 K 30 FT	300	2.5	10	1	110.000	6341535
US 5 K 40 FT	400	2.5	10	1	136.000	6341543
US 5 K 50 FT	500	2.5	10	1	161.000	6341551
US 5 K 60 FT	600	2.5	10	1	185.000	6341578
US 5 K 70 FT	700	2.5	10	1	210.000	6341586
US 5 K 80 FT	800	2.5	10	1	236.000	6341594
US 5 K 90 FT	900	2.5	10	1	261.000	6341608
US 5 K 100 FT	1000	2.5	10	1	286.000	6341616
US 5 K 110 FT	1100	2.5	10	1	311.000	6341624
US 5 K 120 FT	1200	2.5	10	1	337.000	6341632

For fastening to horizontal concrete ceilings and steel girders. For bracket widths of 400 mm or more, or if the bracket is mounted at the end of a suspended support, we recommend the use of the spacer, type DSK 45.

U support of dimensions 50 x 50 mm with welded head plate.

Load diagram, U support, type US 5 K

- 1 Bending of the end of the suspended support at permitted bracket load
 - 2 Permitted bracket load in kN without man load
 - 3 Bracket length in mm
- Load curves with support lengths in mm

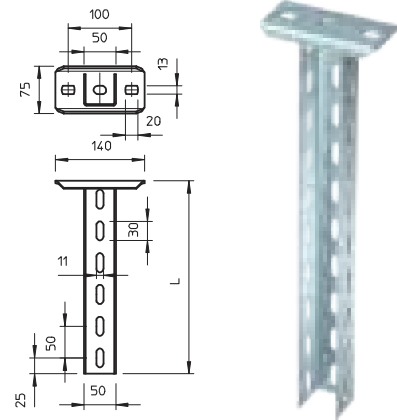

Load

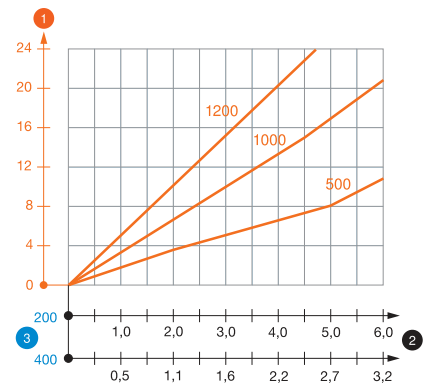

Characteristic anchor load values for US 5 K support

		Single-sided load			
		Max. load F [kN]			
		Bracket width [mm]			
Anchor type		110	210	310	410
	BZ-U 10-10-30/90	1,30	2,75	2,20	1,80
	BZ 12-15-35/110	5,75	4,75	3,85	3,25

		Double-sided load					
		Max. load F [kN]					
		Bracket width [mm]					
Anchor type		110	210	310	410	510	610
	BZ-U 10-10-30/90	6,00	5,80	5,00	4,50	3,80	1,75
	BZ 12-15-35/110	10,00	10,00	9,00	8,00	6,75	5,50

Max. total load F = cable weight + cable tray + bracket + support. The tabular values for double-sided loads take the available axis spacing $a_i = 10$ cm into account. The load capacity values increase considerably when used in uncracked concrete. The values given are based on concrete of strength class C20/25. Observe the installation conditions of the DIBt approval (anchors).

US 5 support

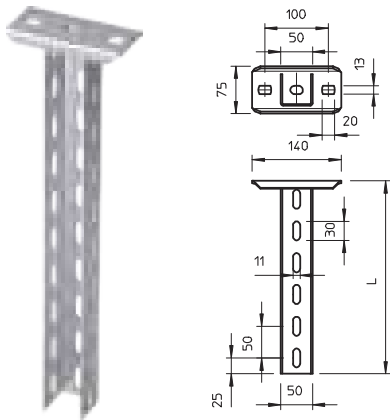

Type	Length mm	Material thickness mm	Tensile load kN	Pack Piece	Weight kg/100 pc.	Item no.
US 5 K 20 A2	200	2.5	10	1	100.000	6341358
US 5 K 30 A2	300	2.5	10	1	125.000	6341362
US 5 K 40 A2	400	2.5	10	1	150.000	6341366
US 5 K 50 A2	500	2.5	10	1	175.000	6341370
US 5 K 60 A2	600	2.5	10	1	200.000	6341374
US 5 K 70 A2	700	2.5	10	1	225.000	6341378
US 5 K 80 A2	800	2.5	10	1	255.000	6341382
US 5 K 90 A2	900	2.5	10	1	280.000	6341386
US 5 K 100 A2	1000	2.5	10	1	300.000	6341390
US 5 K 110 A2	1100	2.5	10	1	330.000	6341394
US 5 K 120 A2	1200	2.5	10	1	360.000	6341398

Suspended support (U profile) with welded head plate.

Load

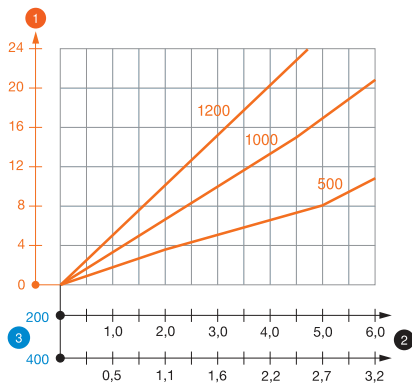

Load diagram, U support, type US 5 K VA

- 1 Bending of the end of the suspended support at permitted bracket load
 - 2 Permitted bracket load in kN without man load
 - 3 Bracket length in mm
- Load curves with support lengths in mm

Characteristic anchor load values for US 5 K support

Single-sided load				
Anchor type	Max. load F [kN]			
	Bracket width [mm]			
	110	210	310	410
BZ-U 10-10/90	1,30	2,75	2,20	1,80
BZ 70 M12-15/110	5,75	4,75	3,85	3,25

Double-sided load						
Anchor type	Max. load F [kN]					
	Bracket width [mm]					
	110	210	310	410	510	610
BZ-U 10-10/90	6,00	5,80	5,00	4,50	3,80	1,75
BZ 70 M12-15/110	10,00	10,00	9,00	8,00	6,75	5,50

Max. total load F = cable weight + cable tray + bracket + support. The tabular values for double-sided loads take the available axis spacing $a_i = 10$ cm into account. The load capacity values increase considerably when used in uncracked concrete. The values given are based on concrete of strength class C20/25. Observe the installation conditions of the DIBt approval (anchors).

Protective cap

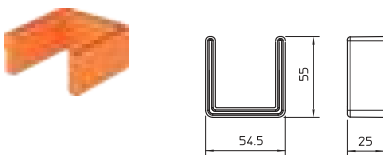

Type	Colour	Pack Piece	Weight kg/100 pc.	Item no.
US 5 KS OR	Pastel orange	20	1.300	6338462

Protective cap to cover the ends of US 5 supports.

US 5 support

Type	Length mm	Material thickness mm	Pack Piece	Weight kg/100 pc.	Item no.
US 5 20 FT	200	2.5	1	51.000	6340881
US 5 30 FT	300	2.5	1	79.000	6340903
US 5 40 FT	400	2.5	1	106.000	6340911
US 5 50 FT	500	2.5	1	133.000	6340938
US 5 60 FT	600	2.5	1	160.000	6340946
US 5 70 FT	700	2.5	1	175.000	6340950
US 5 80 FT	800	2.5	1	200.000	6340954
US 5 90 FT	900	2.5	1	227.000	6340958
US 5 100 FT	1000	2.5	1	265.000	6340962
US 5 150 FT	1500	2.5	1	395.000	6340966
US 5 200 FT	2000	2.5	1	506.000	6340970
US 5 300 FT	3000	2.5	1	795.000	6340989
US 5 30 A2	300	2.5	1	72.000	6341105
US 5 40 A2	400	2.5	1	97.000	6341109
US 5 50 A2	500	2.5	1	121.000	6341113
US 5 60 A2	600	2.5	1	145.000	6341117
US 5 70 A2	700	2.5	1	169.000	6341121
US 5 80 A2	800	2.5	1	193.000	6341125
US 5 90 A2	900	2.5	1	217.000	6341129
US 5 100 A2	1000	2.5	1	242.000	6341133
US 5 110 A2	1100	2.5	1	266.000	6341137
US 5 120 A2	1200	2.5	1	290.000	6341141
US 5 300 A2	3000	2.5	1	737.000	6341152

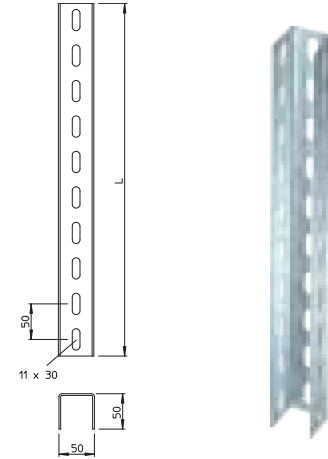

For bracket widths of 400 mm or more, or if the bracket is mounted at the end of a suspended support, we recommend the use of the spacer, type DSK 45.
U support in fixed lengths. Dimensions 50 x 50 mm.

VUS 5 U support connector

Type	Pack Piece	Weight kg/100 pc.	Item no.
VUS 5 FT	10	44.000	6018505

Including appropriate fastening material.
U support connector to connect US 5 supports.

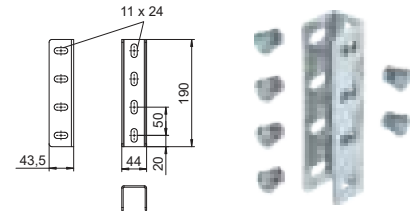

Spacer DSK 45

Type	Pack Piece	Weight kg/100 pc.	Item no.
DSK 45 FT	20	18.000	6416500
DSK 45 A2	10	14.600	6416489

For static reasons, the spacer is always used to increase stability to prevent the support from deforming when the bracket is tightened with the hexagonal bolts.
Spacer for use in US 5 support and in the head plate, type KU 7 VQP.

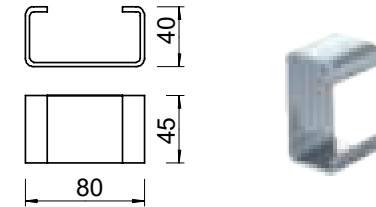

Head plate US 5

Type	Pack Piece	Weight kg/100 pc.	Item no.
KUS 5 FT	1	61.900	6348904

When installing the head plate, please use the spacer, type DSK 45.
Head plate for installation in US 5 support.

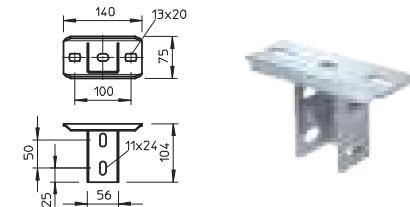

U support system US 5

Head plate US 5 NOK

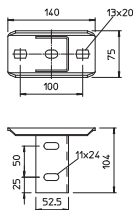

Type

KUS 5 NOK FT

Pack Weight
Piece kg/100 pc. **Item no.**

1	75.000	6348939
---	--------	---------

When installing the head plate, please use the spacer, type DSK 45.

Head plate with U support mounting rotated 90°.

KU 5 head plate, variable

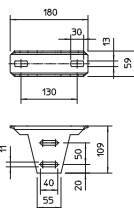

Type

KU 5 V FT

Pack Weight
Piece kg/100 pc. **Item no.**

1	82.000	6348920
---	--------	---------

KU 5 V A2

1	81.000	6348925
---	--------	---------

The spacer, type DSK 47, is used for stabilisation when mounting the head plate. The maximum angle adjustment is approx. 30° on one side.

Variable head plate for installation on US 5 support.

Spacer DSK 47

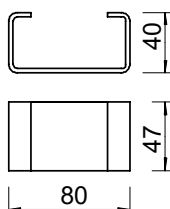

Type

DSK 47 FT

Pack Weight
Piece kg/100 pc. **Item no.**

20	19.000	6416504
----	--------	---------

DSK 47 A2

10	15.600	6416507
----	--------	---------

For static reasons, the spacer is always used to increase stability to prevent the head plate from deforming when the bolts are tightened.

Spacer for use in head plate, type KU 5 V.

Truss-head bolt with nut and washer

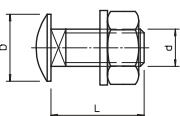

Type

FRS 10x25 F 8.8

Dimen- sion mm	Dim. L mm	Dim. d mm	Dim. D mm	Resist- ance grade
M 10 x 25	25	10	24	8.8

Pack Weight
Piece kg/100 pc. **Item no.**

50	4.500	6407560
----	-------	---------

Truss-head bolt with square neck. With washer and hexagonal nut.

Hexagonal bolt with nut and washer

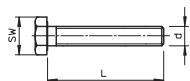

Type

SKS 10x80 F

Dimen- sion mm	Dim. L mm	Dim. d mm	Resist- ance SW mm grade
M 10 x 80	80	10	17 8.8
M 10 x 120	120	10	17 8.8

Pack Weight
Piece kg/100 pc. **Item no.**

20	6.865	6418250
----	-------	---------

SKS 10x120 F

20	13.500	3160793
----	--------	---------

Hexagonal bolt for universal fixing of structure components.

US 7 support



Type	Length mm	Material thickness mm	Tensile load kN	Pack Piece	Weight kg/100 pc.	Item no.
US 7 K 20 FT	200	4	11	1	177.000	6339018
US 7 K 30 FT	300	4	11	1	218.000	6339034
US 7 K 40 FT	400	4	11	1	261.000	6339050
US 7 K 50 FT	500	4	11	1	302.000	6339077
US 7 K 60 FT	600	4	11	1	344.000	6339093
US 7 K 70 FT	700	4	11	1	387.000	6339115
US 7 K 80 FT	800	4	11	1	418.000	6339131
US 7 K 90 FT	900	4	11	1	470.000	6339166
US 7 K 100 FT	1000	4	11	1	512.000	6339182
US 7 K 110 FT	1100	4	11	1	550.000	6339190
US 7 K 120 FT	1200	4	11	1	591.000	6339204
US 7 K 130 FT	1300	4	11	1	636.000	6339212
US 7 K 140 FT	1400	4	11	1	675.000	6339220
US 7 K 150 FT	1500	4	11	1	718.000	6339239
US 7 K 160 FT	1600	4	11	1	760.000	6339247
US 7 K 170 FT	1700	4	11	1	802.000	6339255
US 7 K 180 FT	1800	4	11	1	843.000	6339263
US 7 K 190 FT	1900	4	11	1	884.000	6339271
US 7 K 200 FT	2000	4	11	1	879.722	6339298
US 7 K 250 FT	2500	4	11	1	1,140.000	6339334
US 7 K 300 FT	3000	4	11	1	1,428.000	6339360

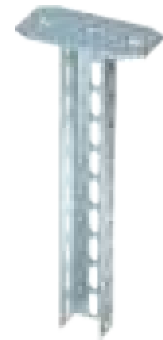
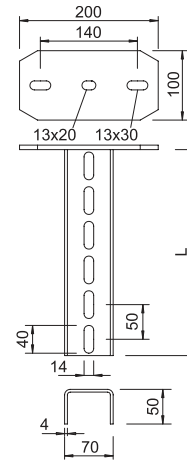

For fastening to horizontal concrete ceilings and steel girders. For bracket widths of 400 mm or more, or if the bracket is mounted at the end of a suspended support, we recommend the use of the spacer, type DSK 61.

Suspended support (U profile) of dimensions 70 x 50 mm with welded head plate.

Load diagram, U support, type US 7 K

- 1 Bending of the end of the suspended support at permitted bracket load
 - 2 Permitted bracket load in kN without man load
 - 3 Bracket length in mm
- Load curves with support lengths in mm

Load

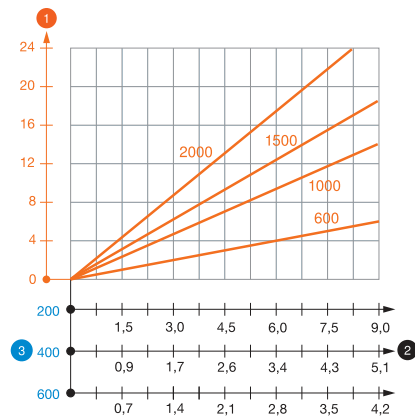

Characteristic anchor load values for U support, type US 7 K

		Single-sided load					
		Max. load F [kN]					
		Bracket width [mm]					
Anchor type		110	210	310	410	510	610
BZ-U 10-10-30/90		4,25	3,25	1,50	2,25	2,00	1,75
BZ 12-15-35/110		7,25	5,50	4,50	4,00	3,50	3,00

		Double-sided load					
		Max. load F [kN]					
		Bracket width [mm]					
Anchor type		110	210	310	410	510	610
BZ-U 10-10-30/90		7,25	6,25	5,75	5,25	4,80	4,50
BZ 12-15-35/110		11,00	11,00	10,00	9,00	8,50	8,00

Max. total load F = cable weight + cable tray + bracket + suspended support. The tabular values for double-sided loads take the available axis spacing $a_i = 14$ cm into account. The load capacity values increase considerably when used in uncracked concrete. The specified values are based on concrete of resistance class C20/25. Comply with the installation conditions of the DIBt approval (anchors).

Type	Colour	Pack Piece	Weight kg/100 pc.	Item no.
US 7 KS OR	Pastel orange	20	1.806	6338497

Protective cap to cover the ends of US 7 supports.

Protective cap

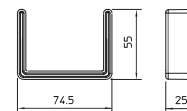

US 7 support

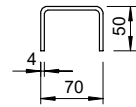
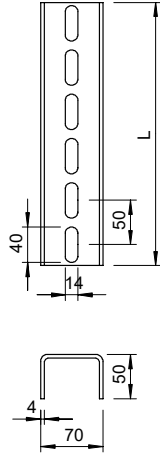

Type	Length mm	Material thickness mm	Pack Piece	Weight kg/100 pc.	Item no.
US 7 20 FT	200	4	1	81.000	6340016
US 7 30 FT	300	4	1	121.000	6340032
US 7 40 FT	400	4	1	160.700	6340059
US 7 50 FT	500	4	1	200.900	6340075
US 7 60 FT	600	4	1	241.100	6340091
US 7 70 FT	700	4	1	281.300	6340113
US 7 80 FT	800	4	1	323.000	6340148
US 7 90 FT	900	4	1	361.700	6340164
US 7 100 FT	1000	4	1	416.000	6340180
US 7 110 FT	1100	4	1	457.000	6340199
US 7 120 FT	1200	4	1	484.000	6340202
US 7 130 FT	1300	4	1	540.000	6340210
US 7 140 FT	1400	4	1	580.000	6340229
US 7 150 FT	1500	4	1	620.000	6340237
US 7 160 FT	1600	4	1	660.000	6340245
US 7 170 FT	1700	4	1	686.000	6340253
US 7 180 FT	1800	4	1	750.000	6340261
US 7 190 FT	1900	4	1	790.000	6340288
US 7 200 FT	2000	4	1	803.700	6340296
US 7 300 FT	3000	4	1	1,250.000	6340377

For bracket widths of 400 mm or more, or if the bracket is mounted at the end of a suspended support, we recommend the use of the spacer, type DSK 61.

U support in fixed lengths. Dimensions 70 x 50 mm.

VUS 7 U support connector

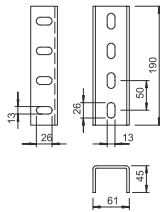

Type	Pack Piece	Weight kg/100 pc.	Item no.
VUS 7 FT	10	112.800	6018378

Including appropriate fastening material.

U support connector to connect US 7 supports.

DSK 61 spacer

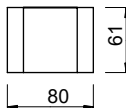

Type	Pack Piece	Weight kg/100 pc.	Item no.
DSK 61 FT	20	25.000	6416519

For static reasons, the spacer is always used to increase stability to prevent the support from deforming when the bracket is tightened with the hexagonal bolts.

Spacer for use in US 7 supports.

Head plate, heavy-duty

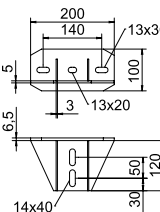

Type	Pack Piece	Weight kg/100 pc.	Item no.
KU 7 NOX FT	1	184.000	6349056

Please order fastening material (two truss-head bolts FRS 12 x 25) separately.

Heavy-duty head plate for installation in US 7 support.

Head plate, variable

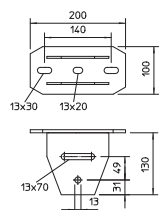

Type	Pack Piece	Weight kg/100 pc.	Item no.
KU 7 VQP FT	10	181.600	6349153

Please order fastening material (two hexagonal bolts SKS 12 x 80 and spacer DSK 45) separately. The maximum angle adjustment is 30° on one side.

Variable head plate for installation on US 7 support.

Spacer DSK 45

Type	Pack Piece	Weight kg/100 pc.	Item no.
DSK 45 FT	20	18.000	6416500
DSK 45 A2	10	14.600	6416489

For static reasons, the spacer is always used to increase stability to prevent the support from deforming when the bracket is tightened with the hexagonal bolts.

Spacer for use in US 5 support and in the head plate, type KU 7 VQP.

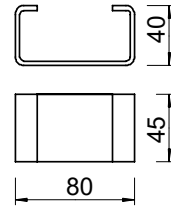

Hexagonal bolt with hexagonal nut, washer and tooth lock washer

Type	Dimension mm	Dim. L mm	Dim. l mm	Dim. d mm	SW mm	Resistance grade	Pack Piece	Weight kg/100 pc.	Item no.
SKS 12x80 F	M 12 x 80	80	30	12	19	8.8	20	11.800	6418287
SKS 12x110 F	M 12 x 110	110	30	12	19	8.8	20	14.500	6418317

Hexagonal bolt with hexagonal nut, washer and tooth lock washer.

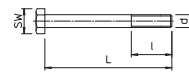

Wall and support bracket AW 15



Type	Width F in kN		Pack Piece	Weight kg/100 pc.	Item no.
	mm	kN			
AW 15 11 FT	110	1.5	30	13.100	6420656
AW 15 16 FT	160	1.5	30	20.000	6420664
AW 15 21 FT	210	1.5	30	24.000	6420680
AW 15 31 FT	310	1.5	30	38.400	6420710
AW 15 41 FT	410	1.5	30	54.000	6420745
AW 15 51 FT	510	1.5	20	67.300	6420788
AW 15 61 FT	610	1.5	20	85.000	6420826

Fastening of the bracket to the U support of width 400 mm or greater using a hexagonal bolt through both sides of the support. Please insert suitable spacers.
Light-duty wall and support bracket with welded head plate.

Dimensions

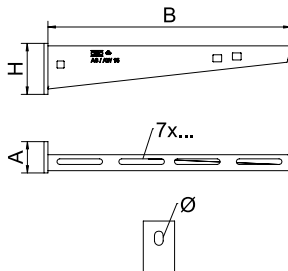

Type	Dim.			
	B mm	A mm	H mm	Hole Ø mm
AW 15 11 FT	110	40	50	11
AW 15 16 FT	160	40	55	11
AW 15 21 FT	210	40	60	11
AW 15 31 FT	310	40	65	11
AW 15 41 FT	410	40	70	11
AW 15 51 FT	510	40	75	11
AW 15 61 FT	610	40	80	11

Load

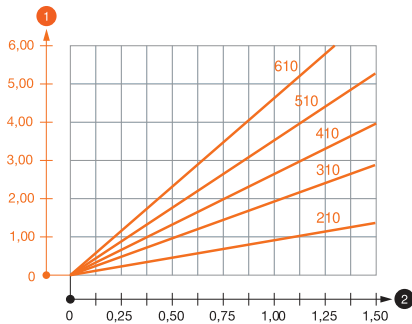

Load diagram, bracket, type AW 15

- 1 Bending of the bracket tip at permitted bracket load
- 2 Permitted bracket load in kN without man load
- Load curve with bracket lengths in mm

Characteristic anchor load values for wall bracket AW 15

Anchor type	Wall fastening							
	Max. load [kN]							
	Bracket width [mm]							
BZ-U 8-10-21/75	110%	160	210	310	410	510	560	610
BZ-U 10-10-30/90	1,50	0,90	1,30	0,65	0,55	2,40	0,45	0,45
	1,50	1,50	1,40	1,50	0,95	0,85	1,30	1,30

Max. total load F = cable weight + cable tray + bracket. The load capacity values increase considerably when used in uncracked concrete. The values given are based on concrete of strength class C20/25. Observe the installation conditions of the DIBt approval (anchors).

Load values for AW 15 on suspended support

Support	Max. total load F in kN			
	Bracket length in mm			
	100	200	300	400
US 3 K/ 20 - 60	1,50	1,50	1,30	1,30
US 3 K/ 70 - 120	1,50	1,50	1,30	1,30
US 5 K/ 20 - 60	1,50	1,50	1,50	1,50
US 5 K/ 70 - 120	1,50	1,50	1,40	1,50

Wall and support bracket AW 15

Type	Width F in kN		Pack Piece	Weight kg/100 pc.	Item no.
	mm	kN			
AW 15 11 A2	110	1.5	30	12.500	6421008
AW 15 21 A2	210	1.5	30	24.000	6421024
AW 15 31 A2	310	1.5	30	38.200	6421032
AW 15 41 A2	410	1.5	30	55.000	6421036
AW 15 51 A2	510	1.5	20	64.400	6421040
AW 15 61 A2	610	1.5	20	85.000	6421044

Fastening of the bracket to the U support of width 400 mm or greater using a hexagonal bolt through both sides of the support. Please insert suitable spacers.
Light-duty wall and support bracket with welded head plate.



Type	Dim. B	Dim. A	Dim. H	Hole Ø
	mm	mm	mm	mm
AW 15 11 A2	110	40	50	11
AW 15 21 A2	210	40	60	11
AW 15 31 A2	310	40	65	11
AW 15 41 A2	410	40	70	11
AW 15 51 A2	510	40	75	11
AW 15 61 A2	610	40	80	11

Dimensions

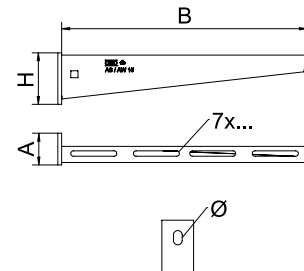

Load

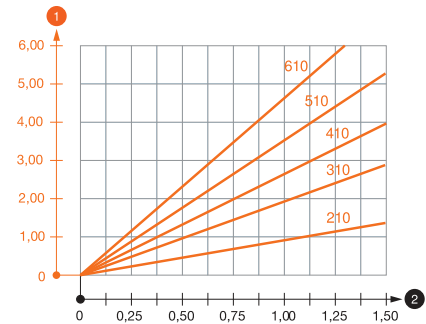

Load diagram, bracket AW 15 VA

- 1 Bending of the bracket tip at permitted bracket load
 - 2 Permitted bracket load in kN without man load
- Load curve with bracket lengths in mm

Characteristic anchor load values for wall bracket AW 15

Anchor	Bracket load						
	Max. total load F in kN						
	Bracket length in mm						
Permitted	100	200	300	400	500	600	655
F kN	3.57	1.09	0.90	0.73	0.65	0.61	0.55

Max. total load F = cable weight + cable tray + bracket. The load capacity values increase considerably when used in uncracked concrete. The values given are based on concrete of strength class C20/25. Observe the installation conditions of the DIBt approval (anchors).

Wall and support bracket AW 30



Type	Width mm	F in kN	Pack Piece	Weight kg/100 pc.	Item no.
AW 30 11 FT	110	3	1	22.000	6419704
AW 30 16 FT	160	3	1	33.000	6419712
AW 30 21 FT	210	3	1	39.300	6419720
AW 30 31 FT	310	3	1	63.000	6419747
AW 30 41 FT	410	3	1	88.500	6419763
AW 30 46 FT	460	3	1	118.000	6419771
AW 30 51 FT	510	3	1	129.000	6419798
AW 30 61 FT	610	3	1	157.000	6419828
AW 30 76 FT	760	3	1	206.700	6419838
AW 30 91 FT	910	3	1	258.900	6419840
AW 30 101 FT	1010	3	1	296.300	6419842

Fastening of the bracket to the U support of width 400 mm or greater using a hexagonal bolt through both sides of the support. Please insert suitable spacers.

Medium-duty wall and support bracket with welded head plate.

Dimensions

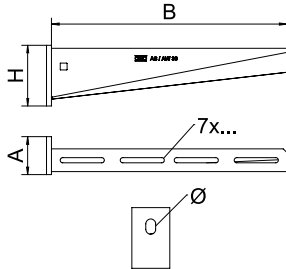

Type	Dim. B mm	Dim. A mm	Dim. H mm	Hole Ø mm
AW 30 11 FT	110	50	60	11
AW 30 16 FT	160	50	65	11
AW 30 21 FT	210	50	70	13
AW 30 31 FT	310	50	80	13
AW 30 41 FT	410	50	80	13
AW 30 46 FT	460	50	90	13
AW 30 51 FT	510	50	90	13
AW 30 61 FT	610	50	100	13
AW 30 76 FT	760	50	110	13
AW 30 91 FT	910	50	130	13
AW 30 101 FT	1010	50	140	13

Load

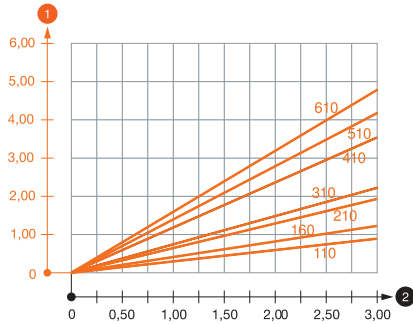

Load diagram, bracket, type AW 30

- 1 Bending of the bracket tip at permitted bracket load
- 2 Permitted bracket load in kN without man load
- Load curve with bracket lengths in mm

Characteristic anchor load values for wall and support bracket AW 30

Wall fastening							
Anchor type	Max. load [kN]						
	Bracket width [mm]						
	110%	160	210	310	410	510	560
BZ-U 10-10-30/90	1,50	2,10	1,65	1,40	1,50	1,00	1,00
BZ 12-15-35/110	3,00	2,65	2,90	1,50	1,90	1,80	1,75
* Values with tray width 600							

Max. total load F = cable weight + cable tray + bracket. The load capacity values increase considerably when used in uncracked concrete. The values given are based on concrete of strength class C20/25. Observe the installation conditions of the DIBt approval (anchors).

Load values for AW 30 on suspended support

Max. total load F in kN				
Support	Bracket length in mm			
	100	200	300	400
US 3 k/ 20-60	2,10	1,80	1,30	1,30
US 3 k/ 70-120	1,80	1,50	1,30	1,30
US 5 k/ 20-60	2,40	2,00	1,80	2,50
US 5 k/ 70-120	2,40	2,00	1,40	2,50

Wall and support bracket AW 30



Type	Width F in kN		Pack Piece	Weight kg/100 pc.	Item no.
	mm	kN			
AW 30 11 A2	110	3	1	21.000	6442803
AW 30 21 A2	210	3	1	37.500	6442838
AW 30 31 A2	310	3	1	60.500	6442854
AW 30 41 A2	410	3	1	85.200	6442870
AW 30 51 A2	510	3	1	124.800	6442897
AW 30 61 A2	610	3	1	154.000	6442919

Fastening of the bracket to the U support of width 400 mm or greater using a hexagonal bolt through both sides of the support. Please insert suitable spacers.
Medium-duty wall and support bracket with welded head plate.



Type	Dim. B	Dim. A	Dim. H	Hole Ø
	mm	mm	mm	mm
AW 30 11 A2	110	50	60	11
AW 30 21 A2	210	50	70	13
AW 30 31 A2	310	50	80	13
AW 30 41 A2	410	50	80	13
AW 30 51 A2	510	50	90	13
AW 30 61 A2	610	50	100	13

Dimensions

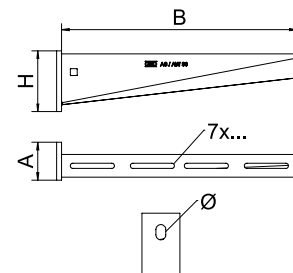

Load

Load diagram, bracket AW 30 VA

- 1 Bending of the bracket tip at permitted bracket load
 - 2 Permitted bracket load in kN without man load
- Load curve with bracket lengths in mm

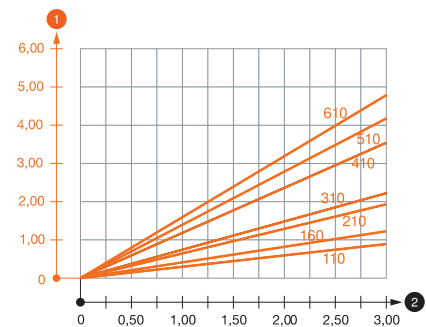

Characteristic anchor load values for wall and support bracket AW 30

Anchor	Bracket load						
	Max. total load F in kN						
	Bracket length in mm						
Permitted	100	200	300	400	500	600	
F kN	3.57	1.66	1.12	0.99	0.76	0.74	0.74
	4.76	2.21	1.50	1.32	1.01	0.99	0.99

Max. total load F = cable weight + cable tray + bracket. The load capacity values increase considerably when used in uncracked concrete. The values given are based on concrete of strength class C20/25. Observe the installation conditions of the DIBt approval (anchors).

Wall and support bracket AW 55

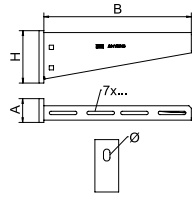

Type	Width mm	F in kN	Pack Piece	Weight kg/100 pc.	Item no.
AW 55 21 FT	210	5.5	1	75.700	6418554
AW 55 31 FT	310	5.5	1	122.000	6418570
AW 55 41 FT	410	5.5	1	164.400	6418597
AW 55 46 FT	460	5.5	1	192.100	6418607
AW 55 51 FT	510	5.5	1	238.200	6418619
AW 55 61 FT	610	5.5	1	305.000	6418635
AW 55 76 FT	760	5.5	1	428.000	6418676
AW 55 81 FT	810	5.5	1	477.000	6418686
AW 55 91 FT	910	5.5	1	558.000	6418708
AW 55 101 FT	1010	5.5	1	640.000	6418724

Fastening of the bracket to the U support of width 400 mm or greater using a hexagonal bolt through both sides of the support. Please insert suitable spacers.

Heavy-duty wall and support bracket with welded head plate.

Dimensions

Type	Dim. B mm	Dim. A mm	Dim. H mm	Hole Ø mm
AW 55 21 FT	210	50	90	13.5
AW 55 31 FT	310	50	110	13.5
AW 55 41 FT	410	50	130	13.5
AW 55 46 FT	460	50	130	13.5
AW 55 51 FT	510	60	145	13.5
AW 55 61 FT	610	60	165	13.5
AW 55 76 FT	760	60	185	13.5
AW 55 81 FT	810	60	195	13.5
AW 55 91 FT	910	60	215	13.5
AW 55 101 FT	1010	60	230	13.5

Load

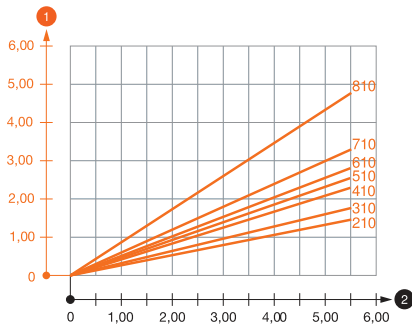

Load diagram, bracket, type AW 55

- 1 Bending of the bracket tip at permitted bracket load
 - 2 Permitted bracket load in kN without man load
- Load curve with bracket lengths in mm

Characteristic anchor load values for wall and support bracket AW 55

Anchor type	Max. load [kN]							
	Bracket width [mm]							
	210	310	410	510	560	610	710	
BZ-U 10-10-30/90	2,20	2,10	2,00	1,90	1,90	1,80	1,75	
BZ 12-15-35/110	3,80	3,50	3,50	3,25	3,30	3,00	3,00	
SZ-B 18/0x142	4,10	4,06	4,02	3,83	3,83	3,56	2,88	

* Values with tray width 600

Max. total load F = cable weight + cable tray + bracket. The load capacity values increase considerably when used in uncracked concrete. The values given are based on concrete of strength class C20/25. Observe the installation conditions of the DIBt approval (anchors).

Chuck jaw, light-duty TKS

Type	Height		F in kN	Pack	Weight	Item no.
	mm	Bolt				
TKS-L-25 FT	25	M10 x 50	10	10	39.000	6355808

The clamping range of the chuck jaw is limited to the maximum fastening thickness, 25 mm.
Chuck jaw with hexagonal nut for direct fastening of structures to steel girders.

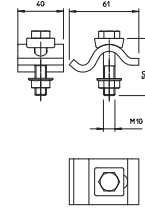

Chuck jaw, light-duty TKH

Type	Height		F in kN	Pack	Weight	Item no.
	mm	Bolt				
TKH-L-25 FT	25	M10 x 25	10	10	46.000	6355812

The clamping range of the chuck jaw is limited to the maximum fastening thickness, 25 mm.
The chuck jaw is used in combination with profile rails of slot widths 18 mm and 22 mm.
Light-duty chuck jaw with slide nut for fixing profile rails to steel girder flanges.

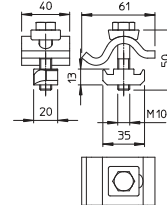

Chuck jaw, heavy-duty TKS

Type	Height		F in kN	Pack	Weight	Item no.
	mm	Bolt				
TKS-S-30 ZL	30	M12 x 75	21	10	82.800	6355798

The clamping range of the chuck jaw is limited to the maximum fastening thickness, 30 mm.
Heavy-duty chuck jaw with hexagonal nut for direct fastening of structures to steel girders.

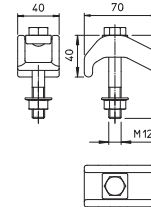

Chuck jaw, heavy-duty TKH

Type	Height		F in kN	Pack	Weight	Item no.
	mm	Bolt				
TKH-S-30 ZL	30	M12 x 65	21	10	88.600	6355805

The clamping range of the chuck jaw is limited to the maximum fastening thickness, 30 mm.
The chuck jaw is used in combination with profile rails of slot width 22 mm.
Heavy-duty chuck jaw with slide nut for fastening profile rails to steel girders.

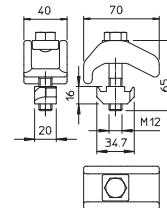

Beam clamp, horizontal BFK 153

Type	Dim.		Pack	Weight	Item no.
	Width	b			
BFK 153 33 FT	—	101	10	37.000	6003884

The cable support system attached to the beam clamp runs horizontally.
Beam clamp for clamping on the steel girder.

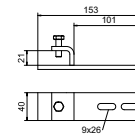

Beam clamp, horizontal BFK 187

Type	Dim.		Pack	Weight	Item no.
	Width	b			
BFK 187 33 FT	—	135	10	43.000	6003892

The cable support system attached to the beam clamp runs horizontally.
Beam clamp for clamping on the steel girder.

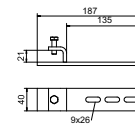

AML3518 anchor rail, slot 16.5 mm, unperforated

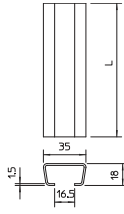

Type	Length mm	Material		Pack Weight		Item no.
		mm	mm	m	kg/100 m	
AML3518UP2000FT	2000	1.5		20	89.400	1118129

Central C profile rail for cable routing, in conjunction with clamp clips with a hammerhead foot. Can also be used as suspension construction for cable support systems.

Anchor rail AML3518, slot width 16.5 mm, perforated

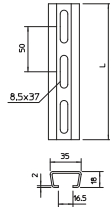

Type	Length mm	Material		Pack Weight		Item no.
		mm	mm	m	kg/100 m	
AML3518P2000FT	2000	1.5		20	89.000	1119656

Central C profile rail for cable routing, in conjunction with clamp clips with a hammerhead foot. Can also be used as suspension construction for cable support systems.

Anchor rail AMS3518, slot 16.5 mm, perforated

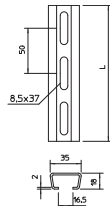

Type	Length mm	Material		Pack Weight		Item no.
		mm	mm	m	kg/100 m	
AMS3518P2000FT	2000	2		20	122.000	1112759

Central C profile rail for cable routing, in conjunction with clamp clips with a hammerhead foot. Can also be used as suspension construction for cable support systems.

CM3015 profile rail, slot 16 mm, perforated

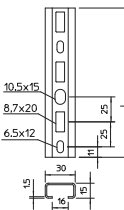

Type	Length mm	Material		Pack Weight		Item no.
		mm	mm	m	kg/100 m	
CM3015P2000FT	2000	1.5		20	73.000	1109871

Profile rail, perforated, slot width 16 mm.

MS5030 mounting rail, slot 22 mm, perforated

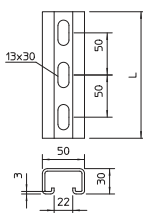

Type	Length mm	Material		Pack Weight		Item no.
		mm	mm	m	kg/100 m	
MS5030P2000FT	2000	3		2	282.500	1121464

Heavy-duty C profile rail for individual installation of support constructions, e.g. for cable trays or as a panel for switchgear cabinets. Can also be used for cable routing, in conjunction with clamp clips with a U foot.

MS4121 mounting rail, slot 22 mm, perforated

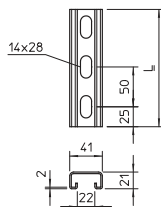

Type	Length mm	Material		Pack Weight		Item no.
		mm	mm	m	kg/100 m	
MS4121P2000FS	2000	2		2	175.000	1122918
MS4121P3000FS	3000	2		3	141.900	1122920

Heavy-duty C profile rail for individual installation of support constructions, e.g. for cable trays or as a panel for switchgear cabinets. Can also be used for cable routing, in conjunction with clamp clips with a U foot.

MS4121 mounting rail, slot 22 mm, perforated

Type	Length mm	Material thickness mm	Pack m	Weight kg/100 m	Item no.
MS4121P3000FT	3000	2	3	151.300	1122924

Heavy-duty C profile rail for individual installation of support constructions, e.g. for cable trays or as a panel for switchgear cabinets. Can also be used for cable routing, in conjunction with clamp clips with a U foot.

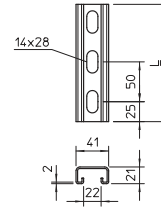

Connection plate with 4 holes

Type	Material thickness mm	Pack Piece	Weight kg/100 pc.	Item no.

Connection plate with four holes for straight connection of profile rails 41 x 41 mm and 41 x 21 mm.

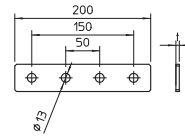

Connection plate with 3 holes

Type	Material thickness mm	Pack Piece	Weight kg/100 pc.	Item no.

Connection plate with three holes for straight connection of profile rails 41 x 41 mm and 41 x 21 mm.

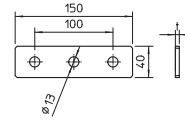

Connection plate with 2 holes

Type	Material thickness mm	Pack Piece	Weight kg/100 pc.	Item no.

Connection plate with two holes for straight connection of profile rails 41 x 41 mm and 41 x 21 mm.

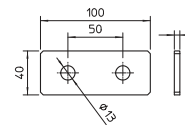

Mounting bracket, 90° with 2 holes

Type	Version	Shipping box Piece	Material thickness mm	Pack Piece	Weight kg/100 pc.	Item no.

Mounting bracket with two holes to connect profile rails 41 x 41 mm and 41 x 21 mm at an angle of 90°.

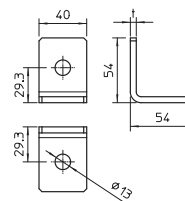

Mounting bracket, 90° with 3 holes

Type	Version	Shipping box Piece	Material thickness mm	Pack Piece	Weight kg/100 pc.	Item no.

Mounting bracket with three holes to connect profile rails 41 x 41 mm and 41 x 21 mm at an angle of 90°.

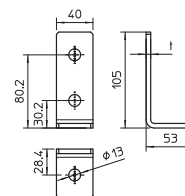

Mounting bracket, 90° with 4 holes

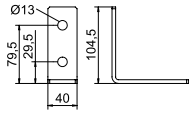

Type	Version	Shipping box		Material thickness mm	Pack Piece	Weight		Item no.
		Piece	mm			kg/100 pc.	pc.	
GMS 4 VW 90 FT	90° angle	30	5	10	32.000		1124663	

Mounting bracket with four holes to connect profile rails 41 x 41 mm and 41 x 21 mm at an angle of 90°.

Mounting bracket, 90° with 6 holes

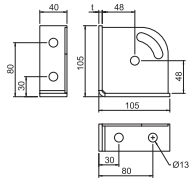

Type	Version	Material thickness mm	Pack Piece	Weight		Item no.
				kg/100 pc.	pc.	
GMS 6 KD FT	90° bracket	5	10	50.900		1124792
GMS 6 KD A2	90° bracket	5	10	48.800		1124796
GMS 6 KD A4	90° bracket	5	10	48.800		1124798

Reinforced mounting bracket with 6 holes to connect profile rails 41 x 41 mm and 41 x 21 mm at an angle of 90°. Additional fastening option for a strut at an angle of 45° with an adjusting range of +/- 30°. Can be used for angles between 15° and 75°.

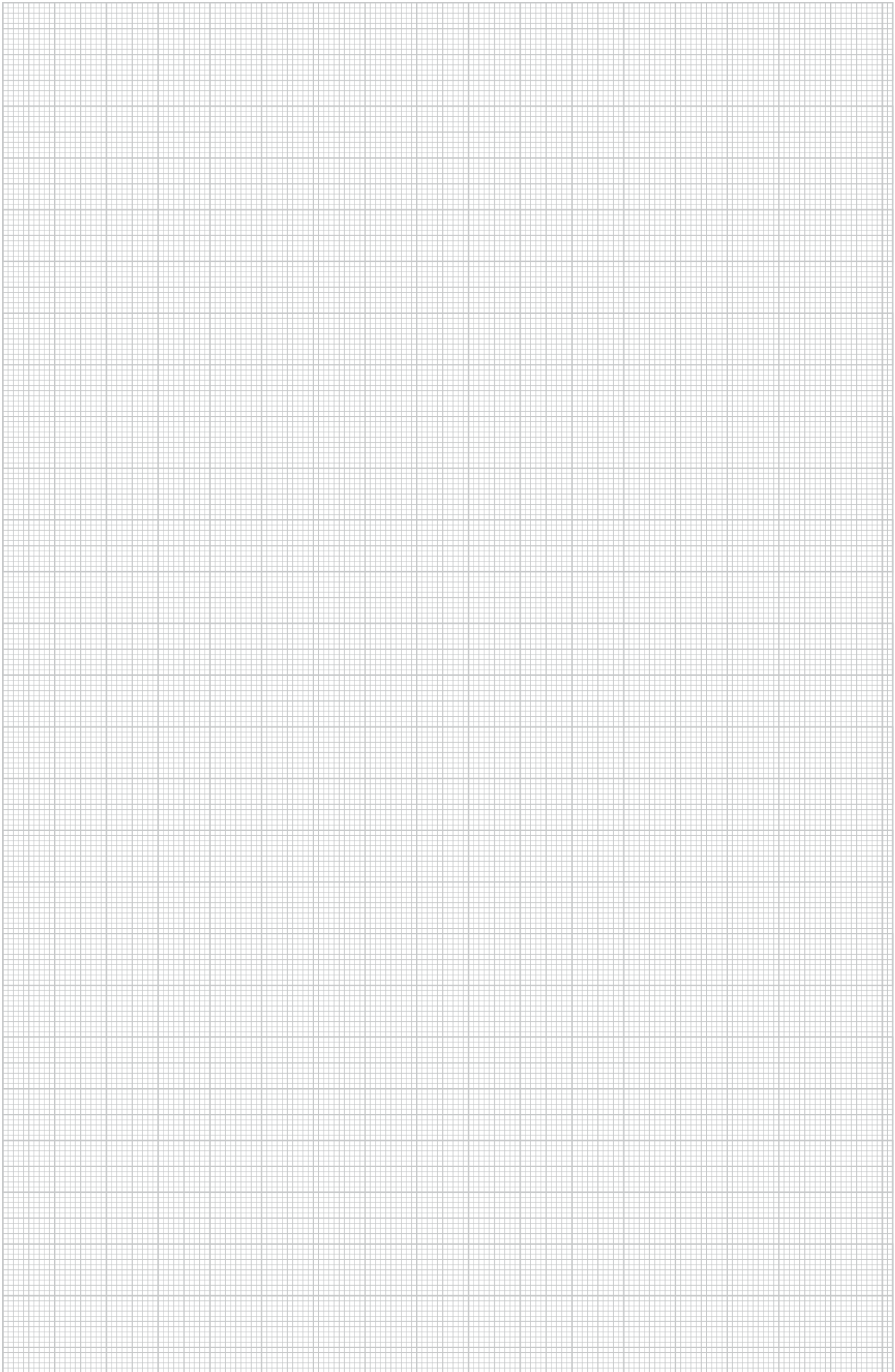



Fastening systems



Screw and fastening systems

68



Anchor systems

70



Earthing systems, surface refinement and edge protection

71



Truss-head bolt with flange nut

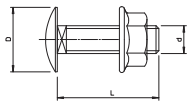

Type	Dimension mm	Dim. L mm	Dim. d mm	Dim. D mm	Resistance grade	Pack Piece	Weight kg/100 pc.	Item no.
FRSB 6x12 VZ G	M 6 x 12	12	6	13.5	5.6	10	0.700	6406133
FRSB 6x12 G	M 6 x 12	12	6	13.5	5.6	100	0.804	6406130
FRSB 6x12 VZ F	M 6 x 12	12	6	13.5	5.6	10	0.840	6406125
FRSB 6x12 F	M 6 x 12	12	6	13.5	5.6	100	0.812	6406122
FRSB 6x20 F	M 6 x 20	20	6	13.5	5.6	100	0.965	6406203
FRSB 6x30 F	M 6 x 30	30	6	13.5	5.6	100	1.232	6406907

For universal fastening of construction components. Permitted use of the article only in dry atmospheres.

Hot galvanised truss-head bolt with square neck including electrogalvanised combination nut.

Truss-head bolt with flange nut

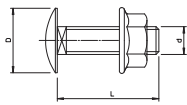

Type	Dimension mm	Dim. L mm	Dim. d mm	Dim. D mm	Resistance grade	Pack Piece	Weight kg/100 pc.	Item no.
FRSB 6x12 A2	M 6 x 12	12	6	13.5	A2-70	100	0.830	6406138

Truss-head bolt with square neck including flange nut.

Truss-head bolt with nut and washer

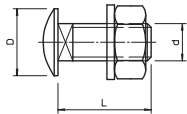

Type	Dimension mm	Dim. L mm	Dim. d mm	Dim. D mm	Resistance grade	Pack Piece	Weight kg/100 pc.	Item no.
FRS 8x16 F 8.8	M 8 x 16	16	8	20	8.8	50	1.947	6406963
FRS 8x16 F 5.6	M 8 x 16	16	8	20	5.6	50	2.000	6406939
FRS 8x20 F	M 8 x 20	20	8	20	5.6	50	2.054	6406971
FRS 8x25 F	M 8 x 25	25	8	20	8.8	50	2.217	6406998
FRS 8x35 F	M 8 x 35	35	8	20	5.6	50	2.431	6407048
FRS 10x25 F 8.8	M 10 x 25	25	10	24	8.8	50	4.500	6407560

The truss-head bolt can be used in combination with hot-dip and double-dip galvanised articles.

Truss-head bolt with square neck. With washer and hexagonal nut.

Hexagonal bolt with nut and washer

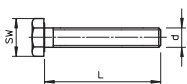

Type	Dimension mm	Dim. L mm	Dim. d mm	Dim. SW mm	Resistance grade	Pack Piece	Weight kg/100 pc.	Item no.
SKS 6x20 F	M 6 x 20	20	6	10	5.6	100	0.900	3156516

Hexagonal bolt for universal fixing of structure components.

Hexagonal bolt with nut and washer

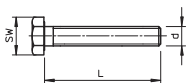

Type	Dimension mm	Dim. L mm	Dim. d mm	Dim. SW mm	Resistance grade	Pack Piece	Weight kg/100 pc.	Item no.
SKS 8x20 F	M 8 x 20	20	8	13	8.8	50	1.500	3158632
SKS 8x30 F	M 8 x 30	30	8	13	5.6	50	2.300	3158640

Hexagonal bolt for universal fixing of structure components.

Hexagonal bolt with nut and washer

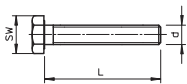

Type	Dimension mm	Dim. L mm	Dim. d mm	Dim. SW mm	Resistance grade	Pack Piece	Weight kg/100 pc.	Item no.
SKS 10x30 F	M 10 x 30	30	10	17	8.8	50	4.400	3160742
SKS 10x80 F	M 10 x 80	80	10	17	8.8	20	6.865	6418250
SKS 10x120 F	M 10 x 120	120	10	17	8.8	20	13.500	3160793

Hexagonal bolt for universal fixing of structure components.

Hexagonal bolt with hexagonal nut, washer and tooth lock washer

Type	Dimension mm	Dim. L mm	Dim. l mm	Dim. d mm	Resistance SW mm	Resistance grade	Pack Piece	Weight kg/100 pc.	Item no.
SKS 12x80 F	M 12 x 80	80	30	12	19	8.8	20	11.800	6418287
SKS 12x110 F	M 12 x 110	110	30	12	19	8.8	20	14.500	6418317

Hexagonal bolt with hexagonal nut, washer and tooth lock washer.

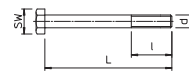

Washer

Type	Thread	Dim. d mm	Dim. D mm	Dim. h mm	Pack Piece	Weight kg/100 pc.	Item no.
WS M8 D16 G	M8	8.4	16	1.6	100	0.156	3402088
WS M10 D20 G	M10	10.5	20	2	100	0.408	3402096
WS M12 D24 G	M12	13	24	2.5	100	0.570	3402126

Washer according to DIN 125, shape A, for universal use.

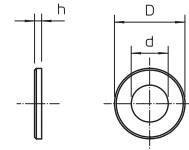

Washer

Type	Thread	Dim. d mm	Dim. D mm	Dim. h mm	Pack Piece	Weight kg/100 pc.	Item no.
966 M8 F	M8	9	16	1.6	100	0.177	3402452

Washer for universal use.

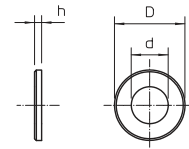

Serrated washer DIN 6798

Type	Thread	Dim. d mm	Dim. D mm	Dim. h mm	Pack Piece	Weight kg/100 pc.	Item no.
SWS M8 G	M8	8.4	15	2.4	100	0.080	3404080
SWS M10 G	M10	10.5	18	2.7	100	0.125	3404102
SWS M12 G	M12	13	20.5	3	100	0.160	3404129

Serrated washer to DIN 6798, shape A.

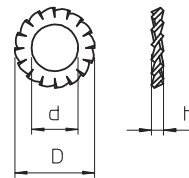

Hexagonal nut DIN 934

Type	Thread	SW mm	Dim. h mm	Dim. d mm	Pack Piece	Weight kg/100 pc.	Item no.
HN M8 G	M8	13	6.8	8	100	0.500	3400085
HN M10 G	M10	17	8.4	10	100	1.014	3400107
HN M12 G	M12	19	10.8	12	100	1.730	3400123

Hexagonal nut to DIN 934 with metric thread.

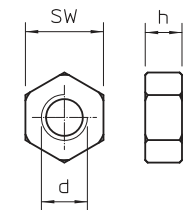

Hexagonal nut ISO 4032

Type	Thread	SW mm	Dim. h mm	Dim. d mm	Pack Piece	Weight kg/100 pc.	Item no.
DIN934 M8 F	M8	13	6.8	8	100	0.477	3400352

Hexagonal nut to DIN 934 with metric thread.

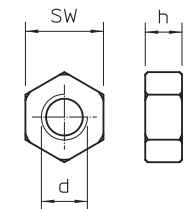

Bolt tie BZ

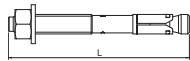

Type	Thread	Dim.		Pack Piece	Weight kg/100 pc.	Item no.
		L	mm			
BZ 12-15-35/110	M12	110		25	10.320	3498350

European Technical Approval ETA-99/0010, including characteristic values under fire exposure to fire resistance R 120.

Proof of suitability in the case of seismic impacts, categories C1 and C2.

Shock approval by the Federal Office for Civil Protection in Bern, Switzerland.

Bolt tie BZ for the anchoring of medium-duty to heavy-duty loads, both in cracked and non-cracked concrete. It combines high approved loads with small edge distances and axial spacings.

Load

Standard anchoring depth

Loads and characteristics	Anchoring depth	Drill hole Ø	Drill hole depth	Clamping strength	Approved load area, tension zone
	mm	mm	mm	mm	kN
M 8-100/165	46	8	60	100	2.4
M 10-75/155	60	10	75	75	4.3
M 10-100/180	60	10	75	100	4.3
M 10-150/230	60	10	75	150	4.3
M 12-15/110	70	12	90	15	7.6
M 12-85/180	70	12	90	85	7.6
M 12-105/200	70	12	90	105	7.6
M 12-160/255	70	12	90	160	7.6
M 16-15/135	85	16	110	15	11.9

Reduced anchoring depth

Loads and characteristics	Anchoring depth	Drill hole Ø	Drill hole depth	Clamping strength	Approved load area, tension zone
	mm	mm	mm	mm	kN
M 8-111/165	35	8	49	111	2.4
M 10-95/155	40	10	55	95	3.6
M 10-120/180	40	10	55	120	3.6
M 12-35/110	50	12	70	35	6.1
M 12-105/180	50	12	70	105	6.1
M 12-125/200	50	12	70	125	6.1
M 16-35/135	65	16	90	35	9.0

Bolt tie BZ-U



Type	Thread	Dim.		Pack Piece	Weight kg/100 pc.	Item no.
		L	mm			
BZ-U 8-30-41/95	M8	95		50	4.010	3498326
BZ-U 10-10-30/90	M10	90		50	6.720	3498334
BZ-U10-30-50/110	M10	110		25	7.900	3498340

European Technical Approval ETA-99/0010, including characteristic values under fire exposure to fire resistance R 120.

Proof of suitability in the case of seismic impacts, categories C1 and C2.

Shock approval by the Federal Office for Civil Protection in Bern, Switzerland.

Bolt tie BZ for the anchoring of medium-duty to heavy-duty loads, both in cracked and non-cracked concrete. It combines high approved loads with small edge distances and axial spacings.

Load

Standard anchoring depth

Loads and characteristic values	Anchoring depth	Drill hole Ø	Drill hole depth	Clamping strength	Permitted load area, tension zone
	mm	mm	mm	mm	kN
M8-10/75	46	8	40	10	2.4
M 8-30/75	46	8	40	30	2.4
M 10-10/90	40	10	75	10	4.3
M 10-30/110	40	10	75	30	4.3

Reduced anchoring depth

Loads and characteristic values	Anchoring depth	Drill hole Ø	Drill hole depth	Clamping strength	Permitted load area, tension zone
	mm	mm	mm	mm	kN
M 8-21/75	35	8	49	21	2.4
M 8-41/95	35	8	49	41	2.4
M 10-30/90	40	10	55	30	3.6
M 10-50/110	40	10	55	50	3.6



Earthing terminal with fastening thread

Type	Dim. L	Dim. I	Cross-section	Thread	Pack Piece	Weight kg/100 pc.	Item no.
	mm	mm					
EKL 25 M6	22	8	50	M6	50	3.100	6404006
EKL 35 M6	26	10	70	M6	50	4.800	6404014

Earthing terminal for fastening the equipotential bonding wire to the cable support system. Suitable for conductor cross sections of 4–50 mm².

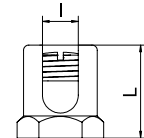
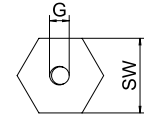

Edge protection strip, black

Type	For metal thickness h		Dim. Colour	Length mm	Pack m	Weight kg/100 m	Item no.
	mm	mm					
KSB 2 PVC	0.75 - 2	10	Black	10000	10	8.000	6072909
KSB 4 PVC	1.5 - 4	15	Black	10000	10	15.000	6072895

Edge protection strip with steel inlay to cover cut plate ends. Black, UV-resistant version.

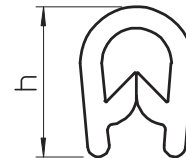

Impact tie, version with collar

Type	Thread	Screw-in depth min.-max. mm	Drill hole Ø mm	Drill hole depth mm	Perm. load range, tension kN	Pack Piece	Weight kg/100 pc.	Item no.
ES M 8x30	M8	9 - 13	10	30	1.7	100	1.100	3492023
ES M 10x40	M10	11 - 15	12	40	2	50	2.100	3492024
ES M 12x50	M12	13 - 18	15	50	2.4	50	4.100	3492026

Impact tie for single fastening of non-load-bearing systems in non-cracked concrete as well as for multiple fastening in cracked and non-cracked concrete.





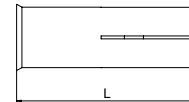

Tested to fire protection standards, fire resistance class R 120 according to European Technical Approval ETA-02/0020 (option 7) and European Technical Approval ETA-05/0116.

Mounting with marking and setting tool.





Cable tray systems

	Side height 60 mm	74
	Side height 85 mm	84
	Side height 110 mm	89
	System accessories 60, 85, 110	96
	GKS cable tray, side height 60 mm	104
	GKS cable tray, side height 100 mm	112



Cable tray SKS 60

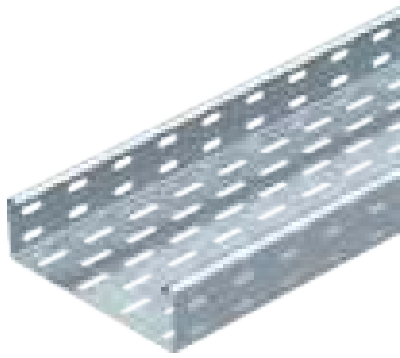

Type	Width mm	Metal thick- ness mm	Pack m	Weight kg/100 m	Item no.
SKS 610 NC FS	100	1.50	3	260.000	6056106
SKS 615 NC FS	150	1.50	3	310.000	6056157
SKS 620 NC FS	200	1.50	3	359.000	6056203
SKS 630 NC FS	300	1.50	3	456.000	6056297
SKS 640 NC FS	400	1.50	3	553.000	6056408
SKS 650 NC FS	500	1.50	3	653.000	6056505
SKS 660 NC FS	600	1.50	3	750.000	6056602
SKS 610 FT	100	1.50	3	277.000	6056636
SKS 615 FT	150	1.50	3	328.700	6056644
SKS 620 FT	200	1.50	3	380.000	6056652
SKS 630 FT	300	1.50	3	485.670	6056679
SKS 640 FT	400	1.50	3	590.340	6056695
SKS 650 FT	500	1.50	3	694.670	6056717
SKS 660 FT	600	1.50	3	799.000	6056733

The cable tray, type SKS, should also be used for the maintenance of electrical function. For additional data, please refer to BSS fire protection systems.

SKS 60 = Heavy-duty cable tray system with 60 mm side height.

Dimensions

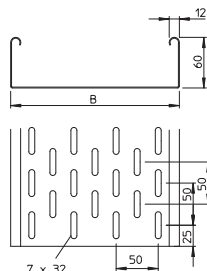

Load

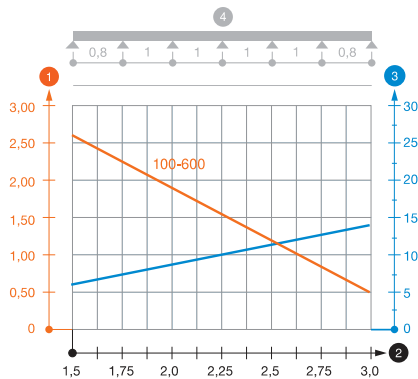

Type	Length mm	Usable Dim. B mm	cross- section cm ²
SKS 610 NC FS	3000	100	58
SKS 615 NC FS	3000	150	88
SKS 620 NC FS	3000	200	118
SKS 630 NC FS	3000	300	178
SKS 640 NC FS	3000	400	238
SKS 650 NC FS	3000	500	298
SKS 660 NC FS	3000	600	358

Type	1.5 m kN/m	2.0 m kN/m	2.5 m kN/m	3.0 m kN/m
SKS 610 NC FS	2.65	1.8	1.15	0.5
SKS 615 NC FS	2.65	1.8	1.15	0.5
SKS 620 NC FS	2.65	1.8	1.15	0.5
SKS 630 NC FS	2.65	1.8	1.15	0.5
SKS 640 NC FS	2.65	1.8	1.15	0.5
SKS 650 NC FS	2.65	1.8	1.15	0.5
SKS 660 NC FS	2.65	1.8	1.15	0.5

Load diagram, cable tray, type SKS 60

- ① Permitted cable tray/ladder load in kN/m without man load
- ② Support width in m
- ③ Rail bend in mm at permitted kN/m
- ④ Load scheme during testing
- Load curve with cable tray/ladder width in mm
- Strut bend curve according to support width

Cable tray SKS 60

Type	Width mm	Metal thick- ness mm	Pack m	Weight kg/100 m	Item no.
SKS 610 A2	100	1.50	3	260.000	6056735
SKS 620 A2	200	1.50	3	356.667	6056737
SKS 630 A2	300	1.50	3	455.333	6056739
SKS 640 A2	400	1.50	3	553.667	6056742
SKS 650 A2	500	1.50	3	651.333	6056744
SKS 660 A2	600	1.50	3	749.333	6056746

Connecting parts should be ordered in the appropriate quantity.
SKS 60 = Heavy-duty cable tray system with 60 mm side height.



Type	Length mm	Dim. B mm	Usable cross- section cm ²
SKS 610 A2	3000	100	58
SKS 620 A2	3000	200	118
SKS 630 A2	3000	300	178
SKS 640 A2	3000	400	238
SKS 650 A2	3000	500	298
SKS 660 A2	3000	600	358

Type	1.5 m kN/m	2.0 m kN/m	2.5 m kN/m	3.0 m kN/m
SKS 610 A2	2.65	1.8	1.15	0.5
SKS 620 A2	2.65	1.8	1.15	0.5
SKS 630 A2	2.65	1.8	1.15	0.5
SKS 640 A2	2.65	1.8	1.15	0.5
SKS 650 A2	2.65	1.8	1.15	0.5
SKS 660 A2	2.65	1.8	1.15	0.5

Load diagram, cable tray, type SKS 60

- 1 Permitted cable tray/ladder load in kN/m without man load
- 2 Support width in m
- 3 Rail bend in mm at permitted kN/m
- 4 Load scheme during testing
- Load curve with cable tray/ladder width in mm
- Strut bend curve according to support width

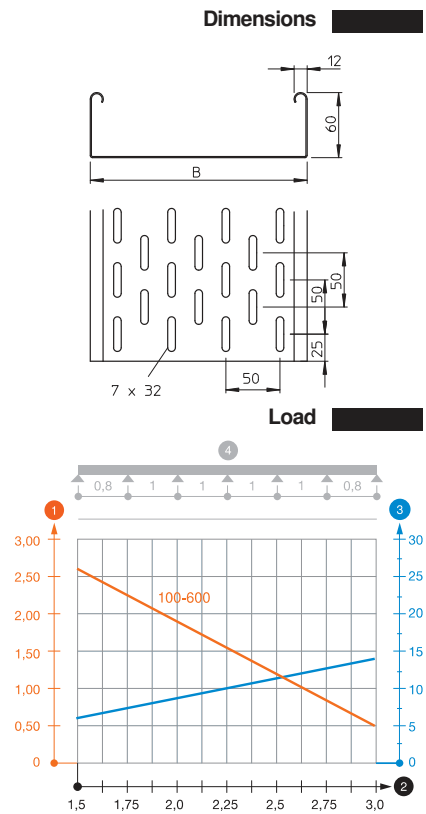

Cable tray EKS 60

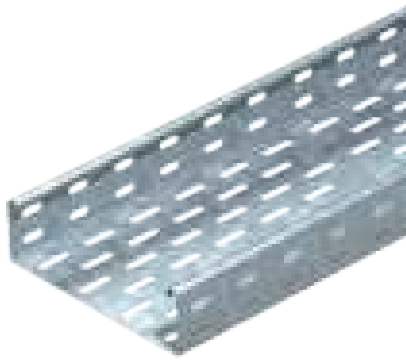

Type	Width mm	Metal thickness mm	Pack m	Weight kg/100 m	Item no.
EKS 610 FS	100	2.00	3	341.340	6056148
EKS 620 FS	200	2.00	3	471.670	6056229
EKS 630 FS	300	2.00	3	602.000	6056326
EKS 640 FS	400	2.00	3	732.670	6056423
EKS 650 FS	500	2.00	3	863.000	6056520
EKS 660 FS	600	2.00	3	993.340	6056628
EKS 610 FT	100	2.00	3	358.340	6056776
EKS 620 FT	200	2.00	3	493.000	6056792
EKS 630 FT	300	2.00	3	629.340	6056806
EKS 640 FT	400	2.00	3	765.670	6056970
EKS 645 FT	450	2.00	3	834.000	6056978
EKS 650 FT	500	2.00	3	902.000	6056989
EKS 660 FT	600	2.00	3	1,038.340	6056997
EKS 675 FT	750	2.00	3	1,250.734	6056996
EKS 690 FT	900	2.00	3	1,455.934	6056998

Straight connectors should be ordered separately for all the versions.
EKS 60 = extra-heavy cable tray system with 60 mm side height.

Dimensions

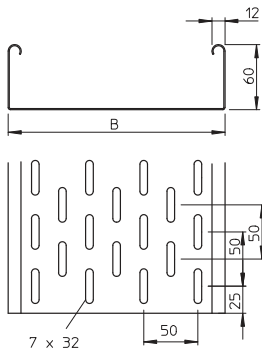

Usable Dim. cross-section
Length B mm mm cm²

Type	Length mm	Dim. B mm	Usable cross-section cm ²
EKS 610 FS	3000	100	58
EKS 620 FS	3000	200	118
EKS 630 FS	3000	300	178
EKS 640 FS	3000	400	238
EKS 645 FT	3000	450	268
EKS 650 FS	3000	500	298
EKS 660 FS	3000	600	358
EKS 675 FT	3000	750	445
EKS 690 FT	3000	900	535

Load

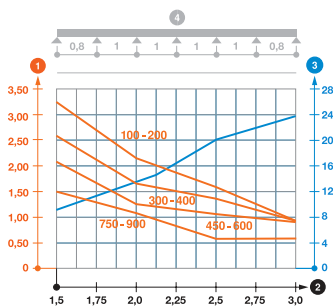

Type 1.5 m 2.0 m 2.5 m 3.0 m
kN/m kN/m kN/m kN/m

Type	1.5 m kN/m	2.0 m kN/m	2.5 m kN/m	3.0 m kN/m
EKS 610 FS	3.3	2.2	1.6	0.95
EKS 620 FS	3.3	2.2	1.6	0.95
EKS 630 FS	2.6	1.7	1.4	0.95
EKS 640 FS	2.6	1.7	1.4	0.95
EKS 650 FS	2.1	1.35	1.15	0.9
EKS 660 FS	2.1	1.35	1.15	0.9

Load diagram, cable tray, type EKS 60

- 1 Permitted cable tray/ladder load in kN/m without man load
- 2 Support width in m
- 3 Rail bend in mm at permitted kN/m
- 4 Load scheme during testing
- Load curve with cable tray/ladder width in mm
- Strut bend curve according to support width

Cable tray SKSU 60

Type	Width mm	Metal thick- ness mm	Pack m	Weight kg/100 m	Item no.
SKSU 610 FS	100	1.50	3	286.000	6063234
SKSU 620 FS	200	1.50	3	399.670	6063236
SKSU 630 FS	300	1.50	3	516.000	6063238
SKSU 640 FS	400	1.50	3	639.000	6063950
SKSU 650 FS	500	1.50	3	756.670	6063241
SKSU 660 FS	600	1.50	3	877.000	6063276

The cable tray has connector perforations on both sides.
Straight connectors should be ordered separately and in the appropriate quantity.
SKSU 60 = heavy-duty cable tray system, unperforated, with 60 mm side height.



Type	Length mm	Dim. B mm	Usable cross- section cm ²
SKSU 610 FS	3000	100	58
SKSU 620 FS	3000	200	118
SKSU 630 FS	3000	300	178
SKSU 640 FS	3000	400	238
SKSU 650 FS	3000	500	298
SKSU 660 FS	3000	600	358

Dimensions

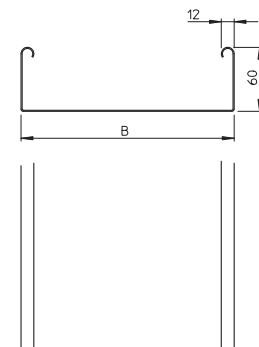

Load

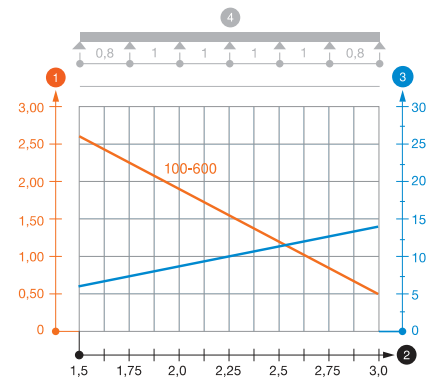

Type	1.5 m kN/m	2.0 m kN/m	2.5 m kN/m	3.0 m kN/m
SKSU 610 FS	2.6	1.9	1.1	0.55
SKSU 620 FS	2.6	1.9	1.1	0.55
SKSU 630 FS	2.6	1.9	1.1	0.55
SKSU 640 FS	2.6	1.9	1.1	0.55
SKSU 650 FS	2.6	1.9	1.1	0.55
SKSU 660 FS	2.6	1.9	1.1	0.55

Load diagram, cable tray, type SKSU 60

- 1 Permitted cable tray/ladder load in kN/m without man load
- 2 Support width in m
- 3 Rail bend in mm at permitted kN/m
- 4 Load scheme during testing
- Load curve with cable tray/ladder width in mm
- Strut bend curve according to support width

Separating retainer 45

Type	Dim. H mm	Metal thick- ness mm	Dim. L mm	Pack m	Weight kg/100 m	Item no.
TSG 45 FS	45	0.75	3000	3	46.700	6062033
TSG 45 A2	45	0.75	3000	3	46.812	6062025

Separating retainer for separation of cables of different voltages or functions.

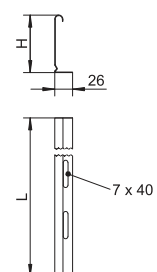

Separating retainer 60

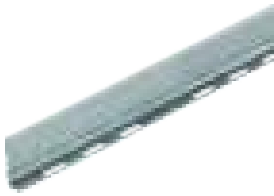

Type	Metal			Pack m	Weight kg/100 m	Item no.
	Dim. H mm	thick- ness mm	Dim. L mm			
TSG 60 FS	60	0.75	3000	3	55.700	6062068
TSG 60 A2	60	0.75	3000	3	55.660	6062084

Separating retainer for separation of cables of different voltages or functions.

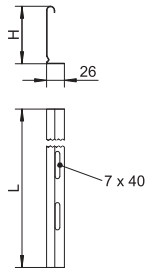

Separating retainer connector



Type	Pack Piece	Weight kg/100 pc.	Item no.
TSGV A2	10	0.899	6067970

Barrier strip connector for screwless connection of the TSG barrier strip in all side heights.

Straight connector 60

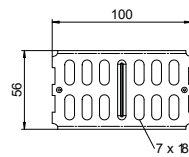

Type	Side height mm	Pack Piece	Weight kg/100 pc.	Item no.
RLVK 60 FS	60	10	9.976	6067093
RLVK 60 FT	60	10	10.300	6067603
RLVK 60 A2	60	10	9.780	6067654

Including appropriate fastening material.

Straight connector for straight connection of cable trays and fittings with a side height of 60 mm.

Straight and angle connector 60

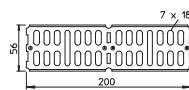

Type	Side height mm	Pack Piece	Weight kg/100 pc.	Item no.
RWVL 60 FS	60	10	16.400	6067115
RWVL 60 FT	60	10	17.400	6067611
RWVL 60 A2	60	10	16.200	6067662

Including appropriate fastening material.

Straight and angle connector for cable trays and fittings with a side height of 60 mm.

Adjustable connector 60

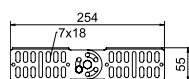

Type	Side height mm	Pack Piece	Weight kg/100 pc.	Item no.
RGV 60 FS	60	10	25.100	7082010
RGV 60 FT	60	10	26.100	7082223
RGV 60 A2	60	10	25.100	7082258

Including appropriate fastening material.

Adjustable connector for cable trays with a side height of 60 mm.

Corner connector 60

Type	Side height mm	Pack Piece	Weight kg/100 pc.	Item no.
REV 60 FS	60	10	32.000	6067972
REV 60 A2	60	5	32.000	6068022

Fastening materials should be ordered separately.

Corner connector for cable trays with side height 60 mm.

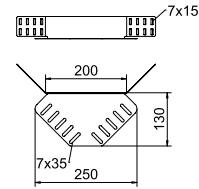

Reducer/stop-end 60

Type	Side height mm	Dim. B mm	Pack Piece	Weight kg/100 pc.	Item no.
RWEB 610 FS	60	100	1	12.300	7109105
RWEB 615 FS	60	150	1	17.600	7109156
RWEB 620 FS	60	200	1	22.800	7109202
RWEB 630 FS	60	300	1	30.700	7109296
RWEB 640 FS	60	400	1	39.600	7109407
RWEB 650 FS	60	500	1	47.500	7109504
RWEB 660 FS	60	600	1	55.500	7109601
RWEB 610 A2	60	100	1	12.500	7109814
RWEB 620 A2	60	200	1	22.900	7109830
RWEB 630 A2	60	300	1	31.200	7109857
RWEB 640 A2	60	400	1	37.300	7109873
RWEB 650 A2	60	500	1	48.100	7109903
RWEB 660 A2	60	600	1	56.100	7109938
RWEB 615 A2	60	150	1	18.000	7109816

From a width of 150 mm, a perforated lower flange is available. Including appropriate fastening material.

Reducer/stop-end plate for cable trays with side height 60 mm.

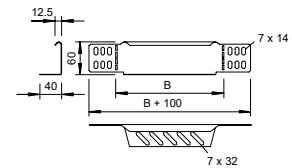
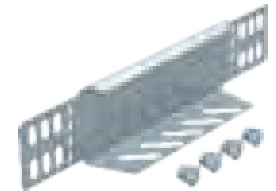

45° bend 60

Type	Side height mm	Dim. B mm	Pack Piece	Weight kg/100 pc.	Item no.
RB 45 610 FS	60	100	1	57.600	6043763
RB 45 615 FS	60	150	1	66.800	6043755
RB 45 620 FS	60	200	1	80.800	6043771
RB 45 630 FS	60	300	1	112.900	6043798
RB 45 610 FT	60	100	1	62.000	7066112
RB 45 615 FT	60	150	1	72.200	7066158
RB 45 620 FT	60	200	1	87.400	7066228
RB 45 630 FT	60	300	1	122.700	7066317
RB 45 610 A2	60	100	1	57.700	7133107
RB 45 620 A2	60	200	1	80.900	7133120
RB 45 630 A2	60	300	1	113.100	7133142

The fitting is shipped in an unmounted state. The WKV 60 angle connector is designed for 90° bends and can be adjusted to 45° on site.

Including appropriate fastening material.

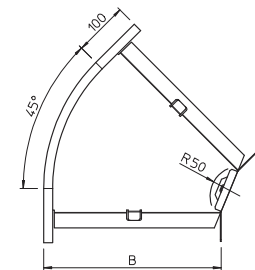

Side height 60

45° bend 60

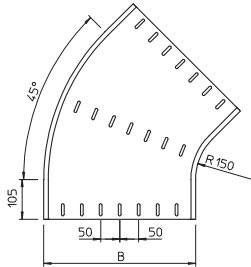
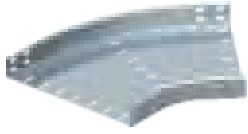

Type	Side height mm	Dim. B mm	Pack Piece	Weight kg/100 pc.	Item no.
RB 45 640 FS	60	400	1	301.000	7000383
RB 45 650 FS	60	500	1	385.900	7000405
RB 45 660 FS	60	600	1	480.400	7000421
RB 45 640 FT	60	400	1	301.000	7066406
RB 45 645 FT	60	450	1	366.100	7066457
RB 45 650 FT	60	500	1	412.800	7066503
RB 45 660 FT	60	600	1	515.600	7066600
RB 45 675 FT	60	750	1	640.000	7066720
RB 45 690 FT	60	900	1	820.000	7066729
RB 45 640 A2	60	400	1	300.700	7133235
RB 45 650 A2	60	500	1	385.900	7133243
RB 45 660 A2	60	600	1	480.400	7133251

Fastening materials should be ordered separately.

90° bend 60

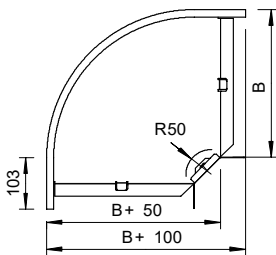

Type	Side height mm	Dim. B mm	Pack Piece	Weight kg/100 pc.	Item no.
RB 90 610 FS	60	100	1	71.900	6043216
RB 90 615 FS	60	150	1	88.400	6043208
RB 90 620 FS	60	200	1	110.300	6043224
RB 90 630 FS	60	300	1	167.400	6043232
RB 90 610 FT	60	100	1	77.600	7125100
RB 90 615 FT	60	150	1	89.500	7125189
RB 90 620 FT	60	200	1	119.600	7125220
RB 90 630 FT	60	300	1	181.200	7125305
RB 90 610 A2	60	100	1	125.000	7134122
RB 90 620 A2	60	200	1	110.400	7134130
RB 90 630 A2	60	300	1	166.600	7134138

The fitting is shipped in an unmounted state. Including appropriate fastening material.

90° bend 60

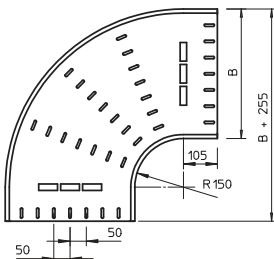

Type	Side height mm	Dim. B mm	Pack Piece	Weight kg/100 pc.	Item no.
RB 90 640 FS	60	400	1	472.300	7001290
RB 90 650 FS	60	500	1	527.000	7001304
RB 90 660 FS	60	600	1	680.000	7001312
RB 90 640 FT	60	400	1	507.000	7125410
RB 90 645 FT	60	450	1	575.000	7125461
RB 90 650 FT	60	500	1	559.000	7125526
RB 90 660 FT	60	600	1	721.500	7125585
RB 90 675 FT	60	750	1	1,242.000	7125586
RB 90 690 FT	60	900	1	1,647.000	7125588
RB 90 640 A2	60	400	1	465.000	7134231
RB 90 650 A2	60	500	1	610.000	7134258
RB 90 660 A2	60	600	1	770.000	7134266

Fitting in round design. The interior radius of the fitting is 150 mm. Fastening materials should be ordered separately.

Add-on tee 60

Type	Side height mm	Dim. B mm	Pack Piece	Weight kg/100 pc.	Item no.
RAA 610 FS	60	100	1	44.200	6040403
RAA 615 FS	60	150	1	40.100	6040411
RAA 620 FS	60	200	1	53.100	6040438
RAA 630 FS	60	300	1	61.900	6040446
RAA 610 FT	60	100	1	47.700	7121109
RAA 615 FT	60	150	1	43.400	7121205
RAA 620 FT	60	200	1	57.500	7121210
RAA 630 FT	60	300	1	67.100	7121318
RAA 610 A2	60	100	1	44.200	7136120
RAA 620 A2	60	200	1	53.200	7136133
RAA 630 A2	60	300	1	61.500	7136141

The fitting is shipped in an unmounted state.
Including appropriate fastening material.

Add-on tee for horizontal and vertical use. For all cable tray types of 60 mm side height.

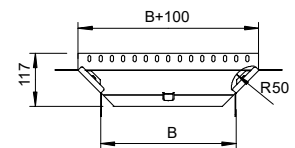
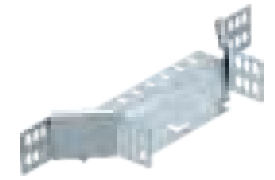

Add-on tee 60

Type	Side height mm	Dim. B mm	Pack Piece	Weight kg/100 pc.	Item no.
RAA 640 FS	60	400	1	220.000	7002394
RAA 650 FS	60	500	1	255.000	7002416
RAA 660 FS	60	600	1	285.000	7002432
RAA 640 FT	60	400	1	240.000	7121407
RAA 650 FT	60	500	1	280.000	7121504
RAA 660 FT	60	600	1	310.000	7121601
RAA 690 FT	60	900	1	527.000	7121609
RAA 640 A2	60	400	1	220.000	7136242
RAA 650 A2	60	500	1	255.000	7136250
RAA 660 A2	60	600	1	285.000	7136269

Fastening materials should be ordered separately.

Add-on tee for horizontal and vertical use. For all cable tray types of 60 mm side height.

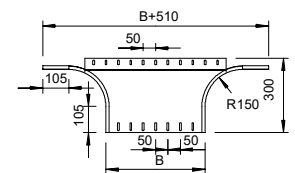

T branch piece 60

Type	Side height mm	Dim. B mm	Pack Piece	Weight kg/100 pc.	Item no.
RT 610 FS	60	100	1	83.200	6043410
RT 615 FS	60	150	1	101.000	6043402
RT 620 FS	60	200	1	133.200	6043429
RT 630 FS	60	300	1	198.200	6043437
RT 610 FT	60	100	1	89.900	7117116
RT 615 FT	60	150	1	109.000	7117162
RT 620 FT	60	200	1	144.800	7117209
RT 630 FT	60	300	1	215.900	7117306

The fitting is shipped in an unmounted state. All the sides are designed for the same cable tray width.
Including appropriate fastening material.

Horizontal T branch piece, for all cable tray types of 60 mm side height.

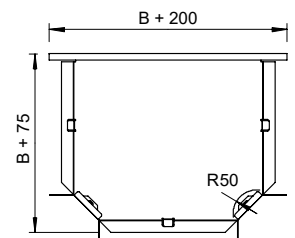

Side height 60

T branch piece 60



Type	Side height mm	Dim. B mm	Pack Piece	Weight kg/100 pc.	Item no.
RT 640 FS	60	400	1	697.000	7003390
RT 650 FS	60	500	1	804.000	7003412
RT 660 FS	60	600	1	1,001.000	7003439
RT 640 FT	60	400	1	746.000	7117396
RT 645 FT	60	450	1	845.200	7117477
RT 650 FT	60	500	1	804.500	7117507
RT 660 FT	60	600	1	1,001.700	7117604
RT 675 FT	60	750	1	1,952.000	7117606
RT 690 FT	60	900	1	2,530.000	7117608

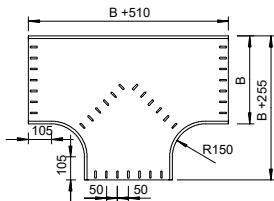

Fitting in round design. The interior radius of the fitting is 150 mm. All the sides are designed for the same cable tray width.

Fastening materials should be ordered separately.

Horizontal T branch piece, for all cable tray types of 60 mm side height.

Cross-over 60



Type	Side height mm	Width mm	Pack Piece	Weight kg/100 pc.	Item no.
RK 610 FS	60	100	1	89.500	6043615
RK 615 FS	60	150	1	111.100	6043607
RK 620 FS	60	200	1	136.200	6043623
RK 630 FS	60	300	1	197.800	6043631
RK 610 FT	60	100	1	97.000	7113110
RK 620 FT	60	200	1	148.300	7113218
RK 630 FT	60	300	1	216.000	7113315

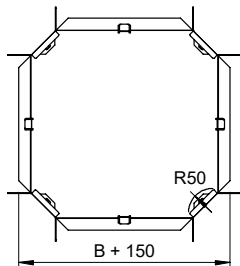

The fitting is shipped in an unmounted state. All the sides are designed for the same cable tray width.

Including appropriate fastening material.

Horizontal cross-over for all cable tray types of 60 mm side height.

Cross-over 60



Type	Side height mm	Dim. B mm	Pack Piece	Weight kg/100 pc.	Item no.
RK 640 FS	60	400	1	800.000	7004397
RK 650 FS	60	500	1	1,120.000	7004419
RK 660 FS	60	600	1	1,291.000	7004435
RK 640 FT	60	400	1	860.000	7113404
RK 650 FT	60	500	1	1,190.000	7113501
RK 660 FT	60	600	1	1,370.000	7113609
RK 675 FT	60	750	1	2,225.000	7113611
RK 690 FT	60	900	1	2,844.000	7113613

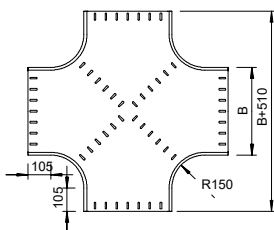

Fitting in round design. The interior radius of the fitting is 150 mm. All the sides are designed for the same cable tray width.

Fastening materials should be ordered separately.

Horizontal cross-over for all cable tray types of 60 mm side height.

90° vertical bend, rising 60

Type	Side height mm	Dim. B mm	Pack Piece	Weight kg/100 pc.	Item no.
RBV 610 S FS	60	100	1	66.000	7007005
RBV 615 S FS	60	150	1	78.000	7007009
RBV 620 S FS	60	200	1	95.000	7007013
RBV 630 S FS	60	300	1	124.000	7007017
RBV 640 S FS	60	400	1	153.000	7007021
RBV 650 S FS	60	500	1	181.000	7007025
RBV 660 S FS	60	600	1	210.000	7007029
RBV 610 S FT	60	100	1	71.000	7007006
RBV 615 S FT	60	150	1	84.000	7007010
RBV 620 S FT	60	200	1	103.000	7007014
RBV 630 S FT	60	300	1	134.000	7007018
RBV 640 S FT	60	400	1	163.000	7007022
RBV 645 S FT	60	450	1	177.000	7007024
RBV 650 S FT	60	500	1	190.000	7007026
RBV 660 S FT	60	600	1	221.000	7007030
RBV 675 S FT	60	750	1	262.000	7007035
RBV 690 S FT	60	900	1	341.000	7007036
RBV 610 S A2	60	100	1	66.000	7007105
RBV 615 S A2	60	150	1	84.000	7007107
RBV 620 S A2	60	200	1	109.000	7007109
RBV 630 S A2	60	300	1	145.000	7007113
RBV 640 S A2	60	400	1	181.000	7007117
RBV 650 S A2	60	500	1	216.000	7007119
RBV 660 S A2	60	600	1	252.000	7007121

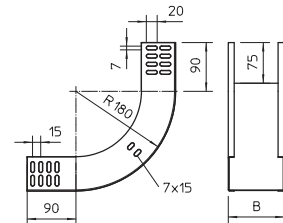

The vertical bend is pushed over the end of the cable tray and screwed tight. Fastening materials should be ordered separately.

90° rising vertical bend, for all cable tray types of 60 mm side height.

90° vertical bend, falling 60

Type	Side height mm	Dim. B mm	Pack Piece	Weight kg/100 pc.	Item no.
RBV 610 F FS	60	100	1	61.000	7007055
RBV 615 F FS	60	150	1	73.000	7007059
RBV 620 F FS	60	200	1	84.000	7007063
RBV 630 F FS	60	300	1	107.000	7007067
RBV 640 F FS	60	400	1	130.000	7007071
RBV 650 F FS	60	500	1	153.000	7007075
RBV 660 F FS	60	600	1	176.000	7007079
RBV 610 F FT	60	100	1	66.000	7007056
RBV 615 F FT	60	150	1	80.000	7007060
RBV 620 F FT	60	200	1	92.000	7007064
RBV 630 F FT	60	300	1	116.000	7007068
RBV 640 F FT	60	400	1	142.000	7007072
RBV 645 F FT	60	450	1	155.000	7007074
RBV 650 F FT	60	500	1	167.000	7007076
RBV 660 F FT	60	600	1	192.000	7007080
RBV 675 F FT	60	750	1	230.000	7007085
RBV 690 F FT	60	900	1	267.000	7007086
RBV 610 F A2	60	100	1	61.000	7007155
RBV 615 F A2	60	150	1	73.000	7007156
RBV 620 F A2	60	200	1	84.000	7007157
RBV 630 F A2	60	300	1	107.000	7007159
RBV 640 F A2	60	400	1	130.000	7007161
RBV 650 F A2	60	500	1	153.000	7007163
RBV 660 F A2	60	600	1	176.000	7007165

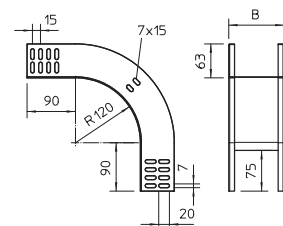

The vertical bend is pushed over the end of the cable tray and screwed tight. Fastening materials should be ordered separately.

90° vertical bend, falling, for all cable tray types of 60 mm side height.

Side height 85

Cable tray SKS 85 NC

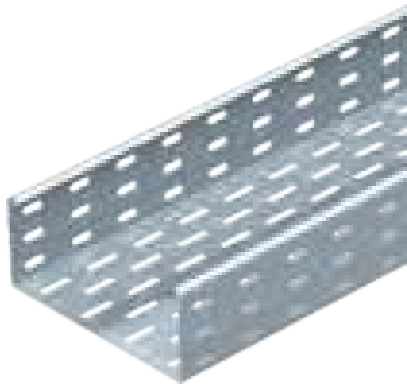

Type	Width mm	Metal thick- ness mm	Pack m	Weight kg/100 m	Item no.
SKS 810 NC FS	100	1.50	3	312.000	6058109
SKS 820 NC FS	200	1.50	3	411.000	6058206
SKS 830 NC FS	300	1.50	3	509.000	6058303
SKS 840 NC FS	400	1.50	3	606.000	6058397
SKS 850 NC FS	500	1.50	3	704.000	6058508
SKS 860 NC FS	600	1.50	3	803.000	6058605
SKS 810 FT	100	1.50	3	334.000	6058620
SKS 820 FT	200	1.50	3	438.340	6058647
SKS 830 FT	300	1.50	3	543.000	6058663
SKS 840 FT	400	1.50	3	644.000	6058698
SKS 850 FT	500	1.50	3	750.340	6058728
SKS 860 FT	600	1.50	3	856.670	6058744

SKS 85 = heavy-duty cable tray system with 85 mm side height.

Dimensions

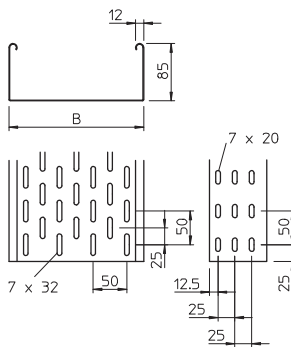

Type	Length mm	Dim. B mm	Usable cross- section cm ²
SKS 810 FT	3000	100	83
SKS 820 FT	3000	200	186
SKS 830 FT	3000	300	253
SKS 840 FT	3000	400	338
SKS 850 FT	3000	500	423
SKS 860 FT	3000	600	508

Load

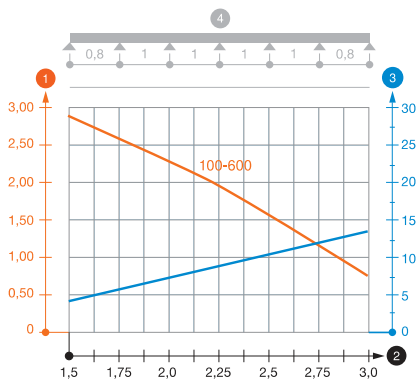

Type	1.5 m kN/m	2.0 m kN/m	2.5 m kN/m	3.0 m kN/m
SKS 810 NC FS	2.8	2.25	1.5	0.75
SKS 820 NC FS	2.8	2.25	1.5	0.75
SKS 830 NC FS	2.8	2.25	1.5	0.75
SKS 840 NC FS	2.8	2.25	1.5	0.75
SKS 850 NC FS	2.8	2.25	1.5	0.75
SKS 860 NC FS	2.8	2.25	1.5	0.75

Load diagram, cable tray, type SKS 85

- ① Permitted cable tray/ladder load in kN/m without man load
- ② Support width in m
- ③ Rail bend in mm at permitted kN/m
- ④ Load scheme during testing
- Load curve with cable tray/ladder width in mm
- Strut bend curve according to support width

Barrier strip 85

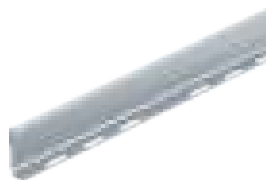

Type	Dim. H mm	Metal thick- ness mm	Dim. L mm	Pack m	Weight kg/100 m	Item no.
TSG 85 FS	85	0.75	3000	3	70.300	6062114

Barrier strip for separation of cables of different voltages or functions.

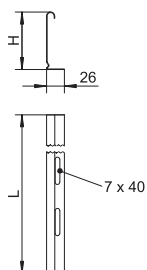

Separating retainer connector

Type	Pack Piece	Weight kg/100 pc.	Item no.

Barrier strip connector for screwless connection of the TSG barrier strip in all side heights.

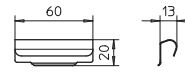

Straight and angle connector 85

Type	Side height mm	Pack Piece	Weight kg/100 pc.	Item no.
RLVL 85 FT	85	10	28.300	6067816

Including appropriate fastening material.

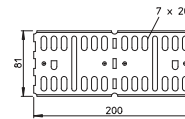

Adjustable connector 85

Type	Side height mm	Pack Piece	Weight kg/100 pc.	Item no.
RGV 85 FT	85	10	45.900	7082320

Including appropriate fastening material.

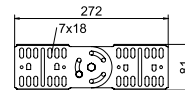

Corner connector 85

Type	Side height mm	Pack Piece	Weight kg/100 pc.	Item no.

Fastening materials should be ordered separately.

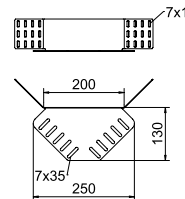

Reducer/stop-end 85

Type	Side height mm	Dim. B mm	Pack Piece	Weight kg/100 pc.	Item no.
RWEB 820 FS	85	200	1	23.000	7110200
RWEB 830 FS	85	300	1	33.000	7110308
RWEB 840 FS	85	400	1	43.000	7110405
RWEB 850 FS	85	500	1	53.000	7110502
RWEB 860 FS	85	600	1	63.000	7110618

From a width of 150 mm, a perforated bottom flange is available. Including appropriate fastening material.

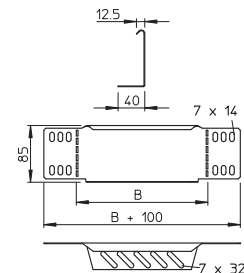
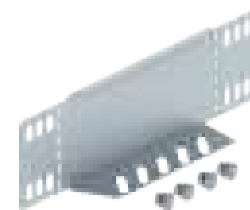

Side height 85

45° bend 85

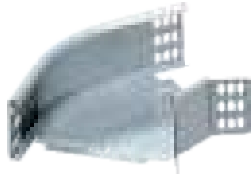

Type	Side	Dim.	Pack	Weight	Item no.
	height	B			
	mm	mm	Piece	kg/100 pc.	
RB 45 810 FS	85	100	1	60.000	7000472
RB 45 820 FS	85	200	1	85.000	7000499
RB 45 830 FS	85	300	1	120.000	7000510
RB 45 810 FT	85	100	1	65.000	7067119
RB 45 820 FT	85	200	1	90.000	7067216
RB 45 830 FT	85	300	1	130.000	7067313

The fitting is shipped in an unmounted state. The WKV 85 angle connector is designed for 90° bends and can be adjusted to 45° on site.

Including appropriate fastening material.

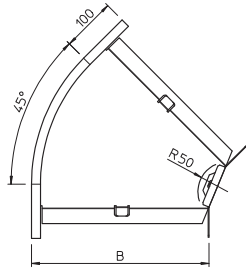

45° bend 85

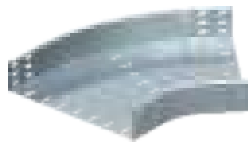

Type	Side	Dim.	Pack	Weight	Item no.
	height	B			
	mm	mm	Piece	kg/100 pc.	
RB 45 840 FS	85	400	1	320.000	7000529
RB 45 850 FS	85	500	1	380.000	7000545
RB 45 860 FS	85	600	1	490.000	7000561
RB 45 840 FT	85	400	1	340.000	7067402
RB 45 850 FT	85	500	1	400.000	7067496
RB 45 860 FT	85	600	1	525.000	7067607

Fastening materials should be ordered separately.

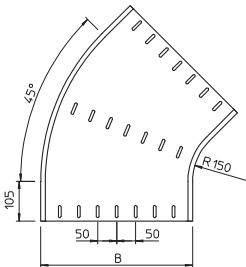

90° bend 85



Type	Side	Dim.	Pack	Weight	Item no.
	height	B			
	mm	mm	Piece	kg/100 pc.	
RB 90 810 FS	85	100	1	65.000	7001762
RB 90 820 FS	85	200	1	150.000	7001789
RB 90 830 FS	85	300	1	180.000	7001800
RB 90 810 FT	85	100	1	70.000	7126127
RB 90 820 FT	85	200	1	160.000	7126216
RB 90 830 FT	85	300	1	200.000	7126301

The fitting is shipped in an unmounted state.

Including appropriate fastening material.

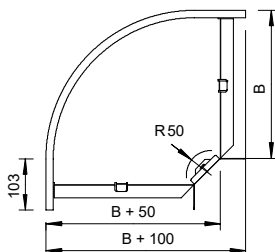

90° bend 85

Type	Side height mm	Dim. B mm	Pack Piece	Weight kg/100 pc.	Item no.
RB 90 840 FS	85	400	1	500.000	7001819
RB 90 850 FS	85	500	1	650.000	7001835
RB 90 860 FS	85	600	1	820.000	7001851
RB 90 840 FT	85	400	1	540.000	7126417
RB 90 850 FT	85	500	1	690.000	7126514
RB 90 860 FT	85	600	1	870.000	7126611

Fastening materials should be ordered separately.

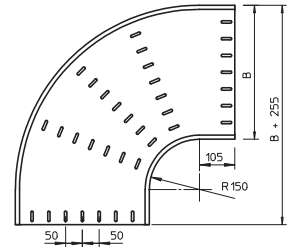

Add-on tee 85

Type	Side height mm	Dim. B mm	Pack Piece	Weight kg/100 pc.	Item no.
RAA 810 FS	85	100	1	40.000	7002475
RAA 820 FS	85	200	1	45.000	7002491
RAA 830 FS	85	300	1	60.000	7002513
RAA 810 FT	85	100	1	45.000	7122109
RAA 820 FT	85	200	1	50.000	7122213
RAA 830 FT	85	300	1	65.000	7122310

The fitting is shipped in an unmounted state.

Including appropriate fastening material.

Add-on tee for horizontal and vertical use. For all cable tray types of 85 mm side height.

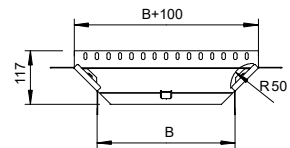
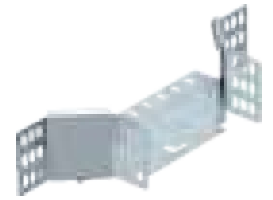

Add-on tee 85

Type	Side height mm	Dim. B mm	Pack Piece	Weight kg/100 pc.	Item no.
RAA 840 FS	85	400	1	230.000	7002521
RAA 850 FS	85	500	1	265.000	7002556
RAA 860 FS	85	600	1	295.000	7002572
RAA 840 FT	85	400	1	250.000	7122403
RAA 850 FT	85	500	1	290.000	7122500
RAA 860 FT	85	600	1	320.000	7122608

Fitting in round design. The interior radius of the fitting is 150 mm. Fastening materials should be ordered separately.

Add-on tee for horizontal and vertical use. For all cable tray types of 85 mm side height.

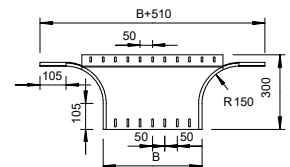

90° vertical bend, rising 85

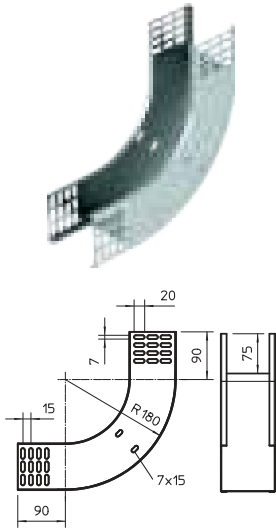

Type	Side height mm	Dim. B mm	Pack Piece	Weight kg/100 pc.	Item no.
RBV 810 S FS	85	100	1	97.100	7007230
RBV 820 S FS	85	200	1	132.600	7007234
RBV 830 S FS	85	300	1	156.200	7007238
RBV 840 S FS	85	400	1	179.900	7007242
RBV 850 S FS	85	500	1	203.500	7007246
RBV 860 S FS	85	600	1	227.100	7007250
RBV 810 S FT	85	100	1	97.100	7007231
RBV 820 S FT	85	200	1	132.600	7007235
RBV 830 S FT	85	300	1	156.200	7007239
RBV 840 S FT	85	400	1	179.900	7007243
RBV 850 S FT	85	500	1	203.500	7007247
RBV 860 S FT	85	600	1	227.100	7007251

The vertical bend is pushed over the end of the cable tray and screwed tight. Fastening materials should be ordered separately.

90° vertical bend, falling 85

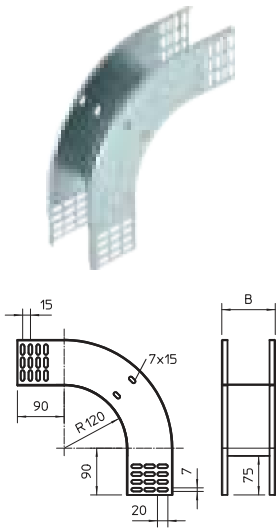

Type	Side height mm	Dim. B mm	Pack Piece	Weight kg/100 pc.	Item no.
RBV 810 F FS	85	100	1	86.600	7007270
RBV 820 F FS	85	200	1	104.200	7007274
RBV 830 F FS	85	300	1	121.800	7007278
RBV 840 F FS	85	400	1	139.500	7007282
RBV 850 F FS	85	500	1	157.100	7007286
RBV 860 F FS	85	600	1	174.700	7007290
RBV 810 F FT	85	100	1	86.600	7007271
RBV 820 F FT	85	200	1	104.200	7007275
RBV 830 F FT	85	300	1	121.800	7007279
RBV 840 F FT	85	400	1	139.500	7007283
RBV 850 F FT	85	500	1	157.100	7007287
RBV 860 F FT	85	600	1	174.700	7007291

The vertical bend is pushed over the end of the cable tray and screwed tight. Fastening materials should be ordered separately.

Cable tray SKS 110 NC

Type	Width mm	Metal thickness mm	Pack m	Weight kg/100 m	Item no.
SKS 110 NC FS	100	1.50	3	367.000	6061110
SKS 120 NC FS	200	1.50	3	463.000	6061207
SKS 130 NC FS	300	1.50	3	563.000	6061304
SKS 140 NC FS	400	1.50	3	660.000	6061401
SKS 150 NC FS	500	1.50	3	756.000	6061509
SKS 110 FT	100	1.50	3	388.680	6061605
SKS 120 FT	200	1.50	3	494.000	6061621
SKS 130 FT	300	1.50	3	598.340	6061656
SKS 140 FT	400	1.50	3	697.340	6061672
SKS 150 FT	500	1.50	3	807.000	6061702

SKS 110 = heavy-duty cable tray system with 110 mm side height.



Type	Length mm	Dim. B mm	Usable cross-section cm ²
SKS 110 FT	3000	100	108
SKS 120 FT	3000	200	218
SKS 130 FT	3000	300	328
SKS 140 FT	3000	400	438
SKS 150 FT	3000	500	548

Dimensions

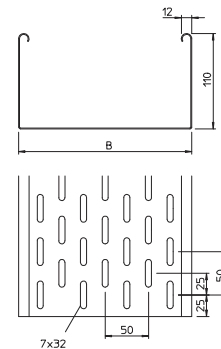

Type	1.5 m kN/m	2.0 m kN/m	3.0 m kN/m	4.0 m kN/m
SKS 110 NC FS	3	2.4	1.2	0.8
SKS 120 NC FS	3	2.4	1.2	0.8
SKS 130 NC FS	3	2.4	1.2	0.8
SKS 140 NC FS	3	2.4	1.2	0.8
SKS 150 NC FS	3	2.4	1.2	0.8

Load

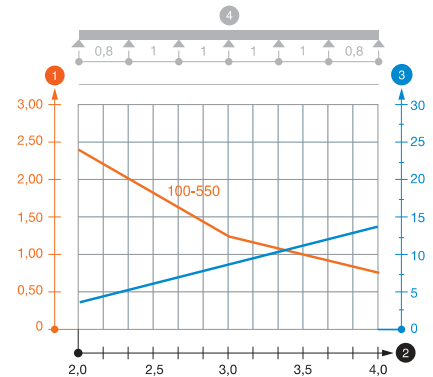

Load diagram, cable tray, type SKS 110

- 1 Permitted cable tray/ladder load in kN/m without man load
- 2 Support width in m
- 3 Rail bend in mm at permitted kN/m
- 4 Load scheme during testing
- Load curve with cable tray/ladder width in mm
- Strut bend curve according to support width

Cable tray SKSU 110



Type	Metal thickness		Pack m	Weight kg/100 m	Item no.
	Width mm	ness mm			
SKSU 110 FS	100	1.50	3	404.000	6063403
SKSU 120 FS	200	1.50	3	520.000	6063438
SKSU 130 FS	300	1.50	3	637.000	6063454
SKSU 140 FS	400	1.50	3	754.700	6063470
SKSU 150 FS	500	1.50	3	872.000	6063497

The cable tray has connector perforations on both sides.
Straight connectors should be ordered separately and in the appropriate quantity.
SKSU 110 = heavy-duty cable tray system, unperforated, with 110 mm side height.

Dimensions

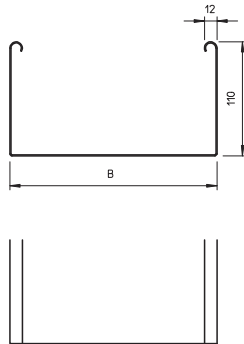

Type	Length mm	Usable Dim. cross-section	
		B mm	cm ²
SKSU 110 FS	3000	100	108
SKSU 120 FS	3000	200	218
SKSU 130 FS	3000	300	328
SKSU 140 FS	3000	400	438
SKSU 150 FS	3000	500	548

Load

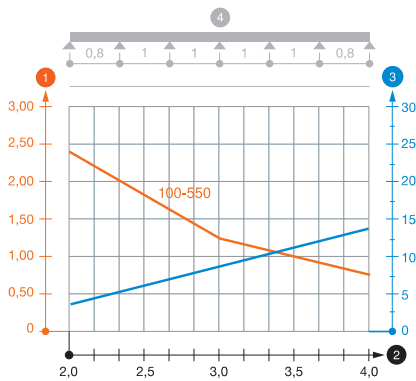

Type	1.5 m 2.0 m 3.0 m 4.0 m			
	kN/m	kN/m	kN/m	kN/m
SKSU 110 FS	3	2.4	1.2	0.8
SKSU 120 FS	3	2.4	1.2	0.8
SKSU 130 FS	3	2.4	1.2	0.8
SKSU 140 FS	3	2.4	1.2	0.8
SKSU 150 FS	3	2.4	1.2	0.8

Load diagram, cable tray, type SKSU 110

- 1 Permitted cable tray/ladder load in kN/m without man load
- 2 Support width in m
- 3 Rail bend in mm at permitted kN/m
- 4 Load scheme during testing
- Load curve with cable tray/ladder width in mm
- Strut bend curve according to support width

Separating retainer 110



Type	Metal Dim. thick- Dim. H mm ness L mm			Pack m	Weight kg/100 m	Item no.
	TSG 110 FS	110	0.75			

Separating retainer for separation of cables of different voltages or functions.

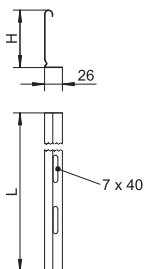

Separating retainer connector

Type	Pack Piece	Weight kg/100 pc.	Item no.

Barrier strip connector for screwless connection of the TSG barrier strip in all side heights.

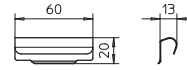

Straight and angle connector 110

Type	Side height mm	Pack Piece	Weight kg/100 pc.	Item no.
RLVL 110 FT	110	10	35.100	6067913
RLVL 110 A2	110	10	33.400	6067948

Including appropriate fastening material.

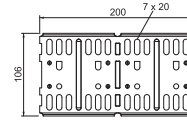

Adjustable connector 110

Type	Side height mm	Pack Piece	Weight kg/100 pc.	Item no.
RGV 110 FT	110	10	64.300	7082436
RGV 110 A2	110	4	61.700	7082479

Including appropriate fastening material.

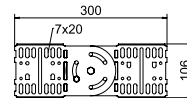

Corner connector 110

Type	Side height mm	Pack Piece	Weight kg/100 pc.	Item no.

Fastening materials should be ordered separately.

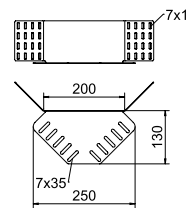

Reducer/stop-end 110

Type	Side height mm	Dim. B mm	Pack Piece	Weight kg/100 pc.	Item no.
RWEB 120 FS	110	200	1	29.000	7111207
RWEB 130 FS	110	300	1	40.700	7111304
RWEB 140 FS	110	400	1	52.900	7111428
RWEB 150 FS	110	500	1	64.800	7111509
RWEB 160 FS	110	600	1	71.000	7111740

From a width of 150 mm, the perforated lower flange is provided.

Including appropriate fastening material.

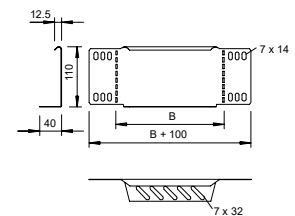
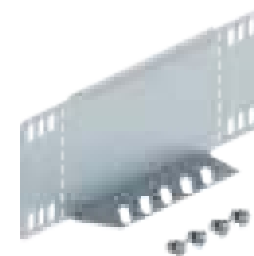

45° bend 110

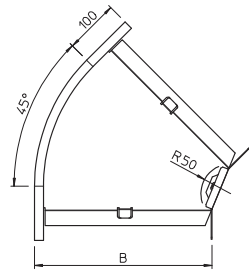
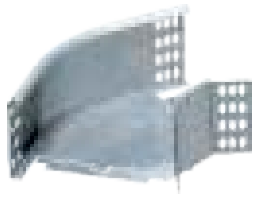

Type	Side height mm	Dim. B mm	Pack Piece	Weight kg/100 pc.	Item no.
RB 45 110 FS	110	100	1	70.000	7000634
RB 45 120 FS	110	200	1	100.000	7000650
RB 45 130 FS	110	300	1	135.000	7000677
RB 45 110 FT	110	100	1	75.000	7068115
RB 45 120 FT	110	200	1	110.000	7068212
RB 45 130 FT	110	300	1	145.000	7068328

The fitting is shipped in an unmounted state. The WKV 110 angle connector is designed for 90° bends and can be adjusted to 45° on site. Including appropriate fastening material.

45° bend 110

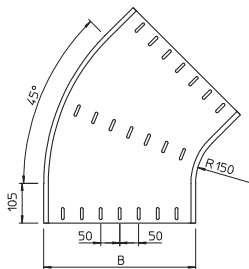
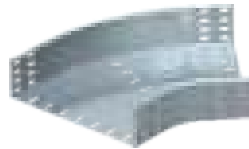

Type	Side height mm	Dim. B mm	Pack Piece	Weight kg/100 pc.	Item no.
RB 45 140 FS	110	400	1	340.000	7000685
RB 45 150 FS	110	500	1	400.000	7000707
RB 45 140 FT	110	400	1	365.000	7068409
RB 45 150 FT	110	500	1	425.000	7068506

Fastening materials should be ordered separately.

90° bend 110

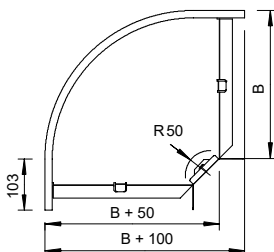

Type	Side height mm	Dim. B mm	Pack Piece	Weight kg/100 pc.	Item no.
RB 90 110 FS	110	100	1	80.000	7001894
RB 90 120 FS	110	200	1	140.000	7001916
RB 90 130 FS	110	300	1	210.000	7001932
RB 90 110 FT	110	100	1	85.000	7127103
RB 90 120 FT	110	200	1	150.000	7127227
RB 90 130 FT	110	300	1	230.000	7127320

The fitting is shipped in an unmounted state. Including appropriate fastening material.

90° bend 110

Type	Side height mm	Dim. B mm	Pack Piece	Weight kg/100 pc.	Item no.
RB 90 140 FS	110	400	1	540.000	7001940
RB 90 150 FS	110	500	1	700.000	7001967
RB 90 140 FT	110	400	1	575.000	7127413
RB 90 150 FT	110	500	1	750.000	7127499
RB 90 160 FT	110	600	1	855.000	7127627

Fastening materials should be ordered separately.

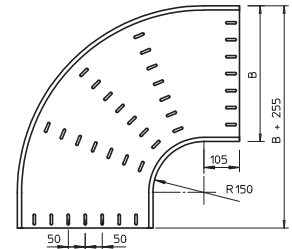

Add-on tee 110

Type	Side height mm	Dim. B mm	Pack Piece	Weight kg/100 pc.	Item no.
RAA 110 FS	110	100	1	45.000	7002637
RAA 120 FS	110	200	1	55.000	7002653
RAA 130 FS	110	300	1	70.000	7002688
RAA 110 FT	110	100	1	50.000	7123116
RAA 120 FT	110	200	1	60.000	7123213
RAA 130 FT	110	300	1	75.000	7123310

The fitting is shipped in an unmounted state.

Including appropriate fastening material.

Add-on tee for horizontal and vertical use. For all cable tray types of 110 mm side height.

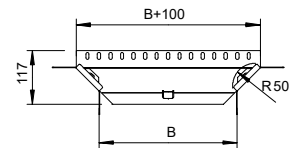
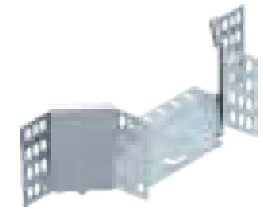

Add-on tee 110

Type	Side height mm	Dim. B mm	Pack Piece	Weight kg/100 pc.	Item no.
RAA 140 FS	110	400	1	250.000	7002696
RAA 150 FS	110	500	1	285.000	7002726
RAA 140 FT	110	400	1	270.000	7123396
RAA 150 FT	110	500	1	310.000	7123507

Fastening materials should be ordered separately.

Add-on tee for horizontal and vertical use. For all cable tray types of 110 mm side height.

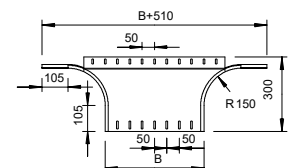

Side height 110

T branch piece 110

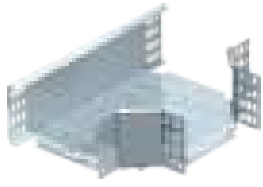

Type	Side height mm	Dim. B mm	Pack	Weight	Item no.
			Piece	kg/100 pc.	
RT 110 FS	110	100	1	105.000	7003633
RT 120 FS	110	200	1	160.000	7003668
RT 130 FS	110	300	1	235.000	7003684
RT 110 FT	110	100	1	110.000	7119119
RT 120 FT	110	200	1	180.000	7119216
RT 130 FT	110	300	1	250.000	7119313

The fitting is shipped in an unmounted state. Including appropriate fastening material.

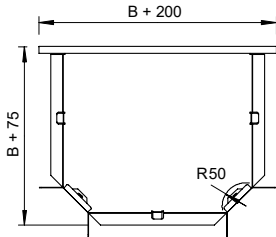

T branch piece 110



Type	Side height mm	Dim. B mm	Pack	Weight	Item no.
			Piece	kg/100 pc.	
RT 140 FS	110	400	1	770.000	7003692
RT 150 FS	110	500	1	950.000	7003714
RT 140 FT	110	400	1	825.000	7119402
RT 150 FT	110	500	1	950.000	7119496

Fastening materials should be ordered separately.

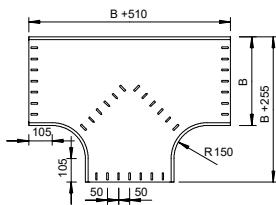

Cross-over 110

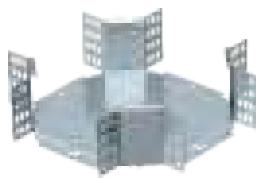

Type	Side height mm	Width mm	Pack	Weight	Item no.
			Piece	kg/100 pc.	
RK 110 FS	110	100	1	110.000	7004648
RK 120 FS	110	200	1	160.000	7004664
RK 130 FS	110	300	1	220.000	7004680
RK 110 FT	110	100	1	120.000	7115113
RK 120 FT	110	200	1	175.000	7115210
RK 130 FT	110	300	1	240.000	7115318

The fitting is shipped in an unmounted state. Including appropriate fastening material.

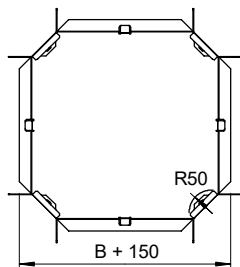

Cross-over 110

Type	Side height mm	Width mm	Pack Piece	Weight kg/100 pc.	Item no.
RK 140 FS	110	400	1	906.000	7004699
RK 150 FS	110	500	1	1,100.000	7004710
RK 140 FT	110	400	1	960.000	7115407
RK 150 FT	110	500	1	1,180.000	7115504
RK 160 FT	110	600	1	1,340.000	7115564

Fastening materials should be ordered separately.

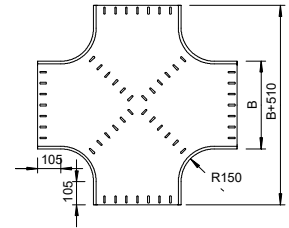

90° vertical bend, rising, 110

Type	Side height mm	Dim. B mm	Pack Piece	Weight kg/100 pc.	Item no.
RBV 110 S FS	110	100	1	120.100	7007310
RBV 120 S FS	110	200	1	151.300	7007314
RBV 130 S FS	110	300	1	182.400	7007318
RBV 140 S FS	110	400	1	213.600	7007322
RBV 150 S FS	110	500	1	244.800	7007326
RBV 160 S FS	110	600	1	274.000	7007333
RBV 110 S FT	110	100	1	120.000	7007398
RBV 120 S FT	110	200	1	163.000	7007400
RBV 130 S FT	110	300	1	182.400	7007319
RBV 140 S FT	110	400	1	231.000	7007404
RBV 150 S FT	110	500	1	244.800	7007327
RBV 160 S FT	110	600	1	299.000	7007334

The vertical bend is pushed over the end of the cable tray and screwed tight.
Fastening materials should be ordered separately.

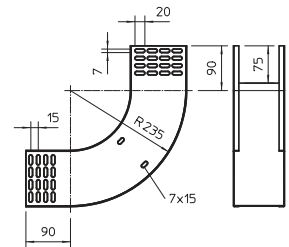

90° vertical bend, falling 110

Type	Side height mm	Dim. B mm	Pack Piece	Weight kg/100 pc.	Item no.
RBV 110 F FS	110	100	1	106.300	7007350
RBV 120 F FS	110	200	1	124.000	7007354
RBV 130 F FS	110	300	1	141.600	7007358
RBV 140 F FS	110	400	1	159.200	7007362
RBV 150 F FS	110	500	1	176.900	7007366
RBV 160 F FS	110	600	1	193.000	7007373
RBV 110 F FT	110	100	1	120.000	7007468
RBV 120 F FT	110	200	1	134.000	7007470
RBV 130 F FT	110	300	1	141.600	7007359
RBV 140 F FT	110	400	1	172.000	7007474
RBV 150 F FT	110	500	1	176.900	7007367
RBV 160 F FT	110	600	1	210.000	7007374

The vertical bend is pushed over the end of the cable tray and screwed tight.
Fastening materials should be ordered separately.

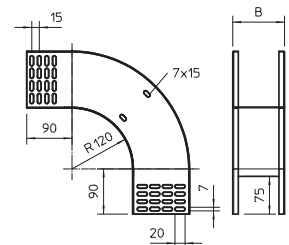

Side height 110

90° adjustable bend, vertical 110

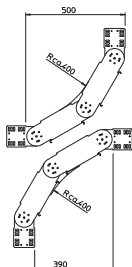

Type	Side height mm	Width mm	Pack Piece	Weight kg/100 pc.	Item no.
RGBV 110 FT	110	100	1	363.000	7081103
RGBV 120 FT	110	200	1	420.000	7081200
RGBV 130 FT	110	300	1	480.000	7081308
RGBV 140 FT	110	400	1	530.000	7081405
RGBV 150 FT	110	500	1	580.000	7081502
RGBV 160 FT	110	600	1	630.000	7081555

The bend is shipped in an unmounted state. No additional fastening materials are required.

90° adjustable vertical bend, for all cable tray types with a side height of 110 mm.

System accessories 60, 85, 110

Joint plate



Type	Dim. B mm	Pack Piece	Weight kg/100 pc.	Item no.
SSLB 100 FS	100	20	7.700	7070205
SSLB 150 FS	150	20	14.000	7070209
SSLB 200 FS	200	20	18.500	7070213
SSLB 300 FS	300	20	29.200	7070217
SSLB 400 FS	400	20	38.200	7070221
SSLB 500 FS	500	20	49.000	7070225
SSLB 600 FS	600	20	58.000	7070233

Including appropriate fastening material.

Wide joint plate for use in all cable trays and wide span cable trays.

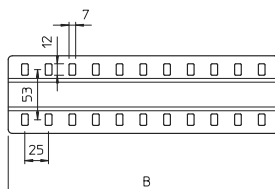

Joint plate



Type	Dim. B mm	Pack Piece	Weight kg/100 pc.	Item no.
SSLB 100 A2	100	20	7.700	7070353
SSLB 200 A2	200	20	18.500	7070361
SSLB 300 A2	300	20	29.200	7070365
SSLB 400 A2	400	20	38.200	7070369
SSLB 500 A2	500	20	49.000	7070373
SSLB 600 A2	600	20	58.000	7070381

Wide joint plate for use in all cable trays and wide span cable trays.

Including appropriate fastening material.

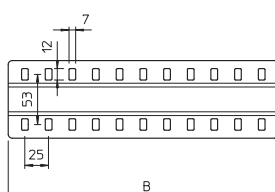

Mounting plate

Type	Height	Width	Pack Piece	Weight	Item no.
	mm	mm		kg/100 pc.	
MP UNI FS	115	170	40	13.300	7084773
MP UNI A2	115	170	40	11.000	7085133

Please order the truss-head bolt, type FRSB 6 x 12, separately.
Mounting plate, for fastening on the side rail of cable support systems.

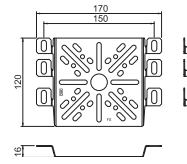

Edge protection strip, black

Type	For metal thickness	Dim. h	Colour	Length mm	Pack m	Weight	Item no.
	mm	mm				kg/100 m	
KSB 2 PVC	0.75 - 2	10	Black	10000	10	8.000	6072909
KSB 4 PVC	1.5 - 4	15	Black	10000	10	15.000	6072895

Edge protection strip with steel inlay to cover cut plate ends. Black, UV-resistant version.

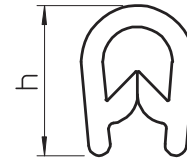

Unperforated cover

Type	Dim. B	Metal thickness	Length mm	Pack m	Weight	Item no.
	mm	mm			kg/100 m	
DRLU 050 FS	50	1.00	3000	3	59.770	6052056
DRLU 100 FS	100	1.00	3000	3	99.000	6052103
DRLU 150 FS	150	1.00	3000	3	138.270	6052153
DRLU 200 FS	200	1.00	3000	3	177.500	6052210
DRLU 300 FS	300	1.00	3000	3	256.000	6052307
DRLU 400 FS	400	1.00	3000	3	334.670	6052405
DRLU 500 FS	500	1.50	3000	3	619.230	6052512
DRLU 600 FS	600	1.50	3000	3	737.000	6052609
DRLU 050 A2	50	1.00	3000	3	59.770	6052821
DRLU 100 A2	100	1.00	3000	3	99.000	6052824
DRLU 150 A2	150	1.00	3000	3	138.240	6052828
DRLU 200 A2	200	1.00	3000	3	177.500	6052831
DRLU 300 A2	300	1.00	3000	3	256.000	6052834
DRLU 400 A2	400	1.00	3000	3	334.500	6052837
DRLU 500 A2	500	1.50	3000	3	619.167	6052841
DRLU 600 A2	600	1.50	3000	3	736.900	6052844

Transverse bead from 500 mm width.
Cover for cable trays and mesh cable trays.
When using covers outdoors, additional measures against the influence of wind must be taken.

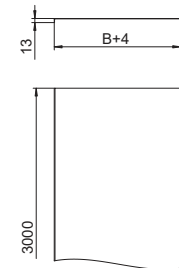

Cover clamp, universal

Type	Pack Piece	Weight	Item no.
		kg/100 pc.	
DKU A2	20	0.794	6065600

Depending on the tray width, 4–6 cover clamps are required for secure fastening of a 3 m cover.
Cover clamp for universal fastening of covers on cable trays, mesh cable trays and AZ small ducts.

The cover clamp is not suitable for use with mesh cable trays with a side height of 35 mm.

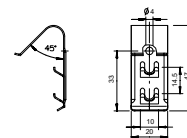

Cover with turn buckle

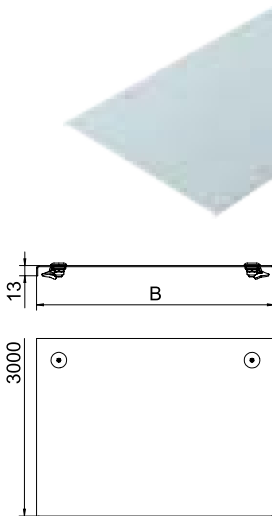

Type	Metal		Length mm	Pack m	Weight kg/100 m	Item no.
	Dim. B mm	thick- ness mm				
DRL 100 FS	100	1.00	3000	3	103.000	6052096
DRL 150 FS	150	1.00	3000	3	141.667	6052150
DRL 200 FS	200	1.00	3000	3	181.340	6052207
DRL 300 FS	300	1.00	3000	3	259.334	6052304
DRL 400 FS	400	1.00	3000	3	338.670	6052401
DRL 500 FS	500	1.25	3000	3	623.000	6052509
DRL 600 FS	600	1.25	3000	3	741.000	6052606
DRL 100 FT	100	1.00	3000	3	106.670	6051340
DRL 150 FT	150	1.00	3000	3	159.340	6051359
DRL 200 FT	200	1.00	3000	3	202.670	6051367
DRL 300 FT	300	1.00	3000	3	289.000	6051383
DRL 400 FT	400	1.50	3000	3	542.000	6051413
DRL 450 FT	450	1.50	3000	3	601.000	6052450
DRL 500 FT	500	1.50	3000	3	667.670	6051448
DRL 600 FT	600	1.50	3000	3	793.000	6051472
DRL 100 A2	100	1.00	3000	3	105.070	6052878
DRL 150 A2	150	1.00	3000	3	144.400	6052886
DRL 200 A2	200	1.00	3000	3	183.500	6052894
DRL 300 A2	300	1.00	3000	3	262.240	6052908
DRL 400 A2	400	1.00	3000	3	340.400	6052932
DRL 500 A2	500	1.25	3000	3	625.340	6052959
DRL 600 A2	600	1.25	3000	3	743.240	6052975

Transverse bead from 500 mm width.

Cover for cable trays and cable ladders with turn buckles.

When using covers outdoors, additional measures against the influence of wind must be taken.

Cover for 45° bend

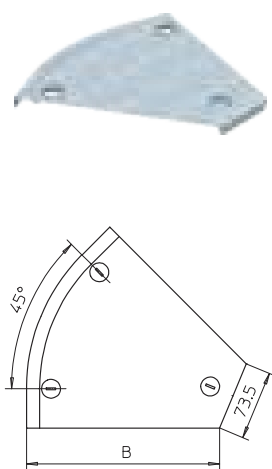

Type	Metal		Pack Piece	Weight kg/100 pc.	Item no.
	Dim. B mm	thick- ness mm			
DFB 45 100 FS	100	1.00	1	19.400	7128819
DFB 45 150 FS	150	1.00	1	27.800	7128827
DFB 45 200 FS	200	1.00	1	36.900	7128835
DFB 45 300 FS	300	1.00	1	60.200	7128851
DFB 45 100 FT	100	1.00	1	19.400	7132002
DFB 45 200 FT	200	1.00	1	36.900	7132004
DFB 45 300 FT	300	1.00	1	60.200	7132006
DFB 45 100 A2	100	1.00	1	14.000	7133901
DFB 45 200 A2	200	1.00	1	35.000	7133928
DFB 45 300 A2	300	1.00	1	55.000	7133936

The cover can be used with fittings of all side heights.

Cover for 45° bend with pre-mounted turn buckle.

Cover for 45° bend

Type	Dim. B mm	Metal thickness mm	Pack Piece	Weight kg/100 pc.	Item no.
DFB 45 400 FS	400	1.25	1	218.600	7128886
DFB 45 500 FS	500	1.25	1	252.800	7128908
DFB 45 600 FS	600	1.25	1	362.800	7128924
DFB 45 400 A2	400	1.25	1	226.800	7133944
DFB 45 600 A2	600	1.25	1	372.300	7133979

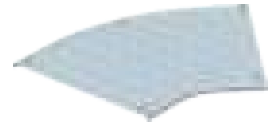

The cover can be used with fittings of all side heights.
Cover for 45° bend with pre-mounted turn buckle.

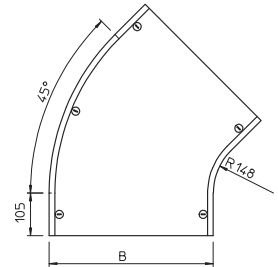

Cover for 90° bend

Type	Dim. B mm	Metal thickness mm	Pack Piece	Weight kg/100 pc.	Item no.
DFB 90 100 FS	100	1.00	1	27.000	7129610
DFB 90 150 FS	150	1.00	1	40.000	7129629
DFB 90 200 FS	200	1.00	1	56.000	7129637
DFB 90 300 FS	300	1.00	1	100.000	7129653
DFB 90 100 FT	100	1.00	1	29.000	7132022
DFB 90 200 FT	200	1.00	1	61.000	7132024
DFB 90 300 FT	300	1.00	1	106.900	7132026
DFB 90 100 A2	100	1.00	1	65.000	7134908
DFB 90 200 A2	200	1.00	1	60.000	7134916
DFB 90 300 A2	300	1.00	1	102.200	7134924



The cover can be used with fittings of all side heights.
Cover for 90° bend with pre-mounted turn buckles.

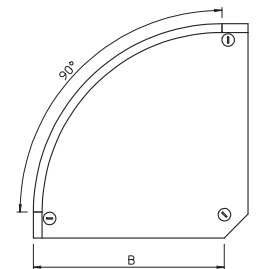

Cover for 90° bend

Type	Dim. B mm	Metal thickness mm	Pack Piece	Weight kg/100 pc.	Item no.
DFB 90 400 FS	400	1.25	1	340.000	7129688
DFB 90 500 FS	500	1.25	1	455.000	7129718
DFB 90 600 FS	600	1.25	1	640.000	7129734
DFB 90 400 A2	400	1.25	1	340.000	7134932
DFB 90 500 A2	500	1.25	1	470.000	7134940
DFB 90 600 A2	600	1.25	1	589.700	7134967



The cover can be used with fittings of all side heights.
Cover for 90° bend with pre-mounted turn buckles.

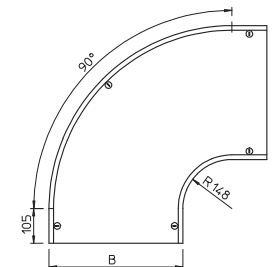

Cover for add-on tee



Type	Metal		Pack Piece	Weight kg/100 pc.	Item no.
	Dim. B mm	thickness mm			
DFAA 100 FS	100	1.00	1	25.000	7128428
DFAA 150 FS	150	1.00	1	30.000	7128436
DFAA 200 FS	200	1.00	1	34.000	7128444
DFAA 300 FS	300	1.00	1	43.000	7128460
DFAA 100 A2	100	1.00	1	26.700	7136900
DFAA 200 A2	200	1.00	1	35.800	7136919
DFAA 300 A2	300	1.00	1	44.800	7136927

The cover can be used with fittings of all side heights.
Cover for add-on tee with pre-mounted turn buckles.

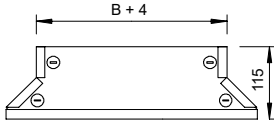

Cover for add-on tee

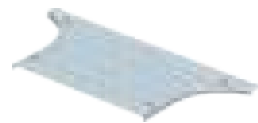

Type	Metal		Pack Piece	Weight kg/100 pc.	Item no.
	Dim. B mm	thickness mm			
DFAA 400 FS	400	1.25	1	145.000	7128487
DFAA 500 FS	500	1.25	1	174.000	7128509
DFAA 600 FS	600	1.25	1	200.000	7128525
DFAA 400 A2	400	1.25	1	176.800	7136935
DFAA 500 A2	500	1.25	1	208.000	7136943
DFAA 600 A2	600	1.25	1	240.000	7136978

The cover can be used with fittings of all side heights.
Cover for add-on tee with pre-mounted turn buckles.

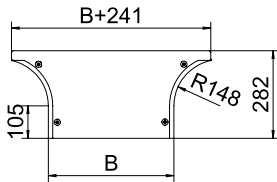

Cover for tee



Type	Metal		Pack Piece	Weight kg/100 pc.	Item no.
	Dim. B mm	thickness mm			
DFT 100 FS	100	1.00	1	30.400	7128215
DFT 150 FS	150	1.00	1	40.000	7128223
DFT 200 FS	200	1.00	1	60.000	7128231
DFT 300 FS	300	1.00	1	115.000	7128266

The cover can be used with fittings of all side heights.
Cover for tee with pre-mounted turn buckle.

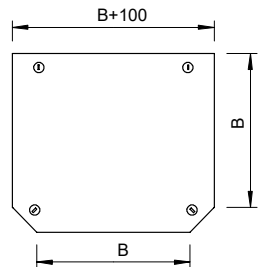

Cover for tee

Type	Dim. B mm	Metal thickness mm	Pack Piece	Weight kg/100 pc.	Item no.
DFT 500 FS	500	1.25	1	670.000	7128304
DFT 600 FS	600	1.25	1	854.000	7128320

The cover can be used with fittings of all side heights.

Cover for tee with pre-mounted turn buckle.

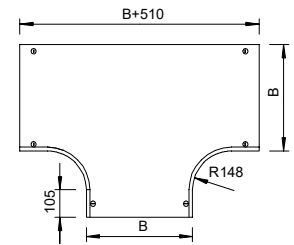
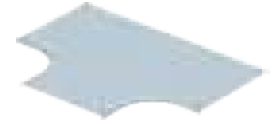

Cover for cross-over

Type	Dim. B mm	Metal thickness mm	Pack Piece	Weight kg/100 pc.	Item no.
DFK 150 FS	150	1.25	1	62.500	7128622
DFK 200 FS	200	1.25	1	83.500	7128630
DFK 300 FS	300	1.25	1	138.500	7128657

The cover can be used with fittings of all side heights.

Cover for cross-over with pre-mounted turn buckles.

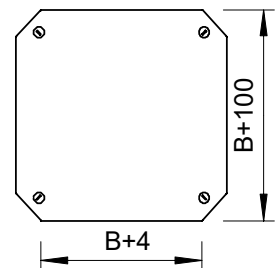

Cover for cross-over

Type	Dim. B mm	Metal thickness mm	Pack Piece	Weight kg/100 pc.	Item no.
DFK 500 FS	500	1.25	1	810.000	7128703
DFK 600 FS	600	1.25	1	1,020.000	7128738

The cover can be used with fittings of all side heights.

Cover for cross-over with pre-mounted turn buckles.

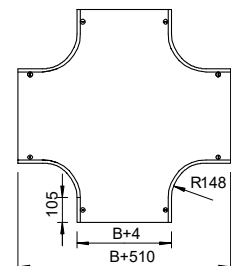

Cover for 90° vertical bend, rising

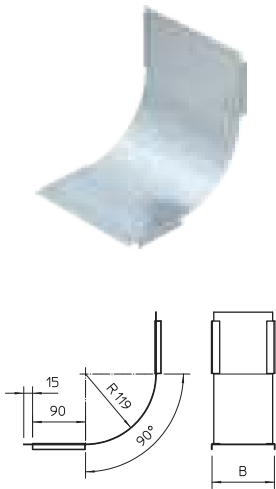

Type	Side height mm	Dim. B mm	Metal thickness mm	Pack	Weight	Item no.
				Piece	kg/100 pc.	
DBV 100 S FS	60	100	0.75	1	21.000	7130805
DBV 150 S FS	60	150	0.75	1	30.000	7130809
DBV 200 S FS	60	200	0.75	1	39.000	7130813
DBV 300 S FS	60	300	0.75	1	49.000	7130817
DBV 400 S FS	60	400	0.75	1	68.000	7130821
DBV 500 S FS	60	500	0.75	1	86.000	7130825
DBV 600 S FS	60	600	0.75	1	105.000	7130829
DBV 100 S A2	60	100	0.75	1	34.000	7130905
DBV 150 S A2	60	150	0.75	1	50.000	7130906
DBV 200 S A2	60	200	0.75	1	39.000	7130907
DBV 300 S A2	60	300	0.75	1	49.000	7130909
DBV 400 S A2	60	400	0.75	1	68.000	7130911
DBV 500 S A2	60	500	0.75	1	86.000	7130913
DBV 600 S A2	60	600	0.75	1	105.000	7130915

The fastening is guaranteed by the overlap of the cable tray covers. The cover can also be fastened using cover clamps.

Cover for all rising vertical bends.

Cover for 90° vertical bend, falling

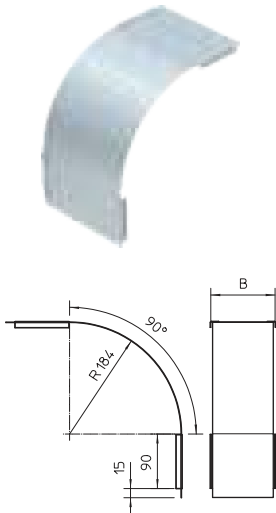

Type	Side height mm	Dim. B mm	Metal thickness mm	Pack	Weight	Item no.
				Piece	kg/100 pc.	
DBV 60 100 F FS	60	100	0.75	1	25.200	7130852
DBV 60 150 F FS	60	150	0.75	1	36.900	7130856
DBV 60 200 F FS	60	200	0.75	1	48.700	7130860
DBV 60 300 F FS	60	300	0.75	1	72.300	7130864
DBV 60 400 F FS	60	400	0.75	1	95.800	7130868
DBV 60 500 F FS	60	500	0.75	1	119.300	7130872
DBV 60 600 F FS	60	600	0.75	1	142.800	7130876
DBV 60 100 F A2	60	100	0.75	1	42.100	7130952
DBV 60 150 F A2	60	150	0.75	1	61.700	7130953
DBV 60 200 F A2	60	200	0.75	1	81.300	7130954
DBV 60 300 F A2	60	300	0.75	1	120.400	7130956
DBV 60 400 F A2	60	400	0.75	1	159.600	7130958
DBV 60 500 F A2	60	500	0.75	1	198.800	7130960
DBV 60 600 F A2	60	600	0.75	1	238.000	7130962

The fastening is guaranteed by the overlap of the cable tray covers. The cover can also be fastened using cover clamps.

Cover for 90° vertical bend 85, falling

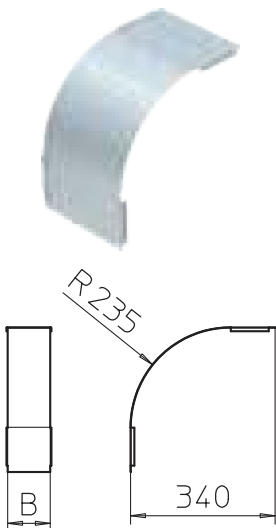

Type	Side height mm	Dim. B mm	Metal thickness mm	Pack	Weight	Item no.
				Piece	kg/100 pc.	
DBV 85 100 F FS	85	100	0.75	1	27.100	7130990
DBV 85 200 F FS	85	200	0.75	1	52.500	7130994
DBV 85 300 F FS	85	300	0.75	1	77.800	7130998
DBV 85 400 F FS	85	400	0.75	1	103.200	7131002
DBV 85 500 F FS	85	500	0.75	1	128.500	7131006
DBV 85 600 F FS	85	600	0.75	1	153.900	7131010

The fastening is guaranteed by the overlap of the cable tray covers. The cover can also be fastened using cover clamps.

Cover for 90° vertical bend 110, falling

Type	Side height mm	Dim. B mm	Metal thick- ness mm	Pack Piece	Weight kg/100 pc.	Item no.
DBV 110 100 F FS	110	100	0.75	1	29.000	7131030
DBV 110 150 F FS	110	150	0.75	1	42.600	7131032
DBV 110 200 F FS	110	200	0.75	1	56.200	7131034
DBV 110 300 F FS	110	300	0.75	1	83.400	7131038
DBV 110 400 F FS	110	400	0.75	1	110.600	7131042
DBV 110 500 F FS	110	500	0.75	1	137.800	7131046
DBV 110 600 F FS	110	600	0.75	1	165.000	7131052

The fastening is guaranteed by the overlap of the cable tray covers. The cover can also be fastened using cover clamps.

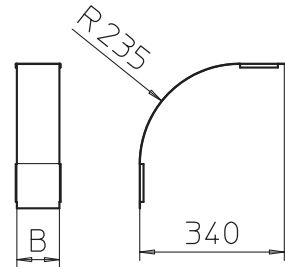

Side height 60 GKS

Cable tray GKS FL 60

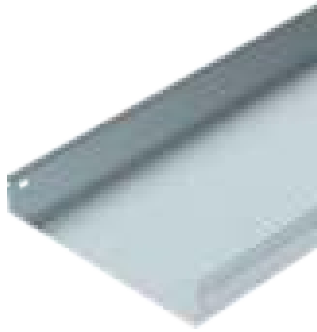

Type	Side height mm	Width mm	Metal thick- ness mm	Pack m	Weight kg/100 m	Item no.
GKS FL 610 FS	60	100	0.60	3	109.270	6480001
GKS FL 615 FS	60	150	0.70	3	154.960	6480002
GKS FL 620 FS	60	200	0.70	3	182.430	6480003
GKS FL 630 FS	60	300	1.00	3	339.120	6480004
GKS FL 640 FS	60	400	1.20	3	501.140	6480005
GKS FL 650 FS	60	500	1.20	3	595.340	6480006

GKS 60 FL = unperforated cable tray system with 60 mm side height

Dimensions

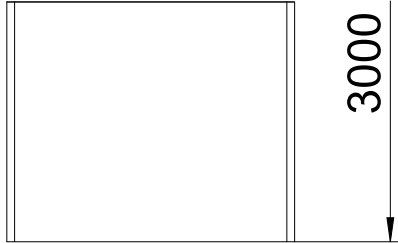
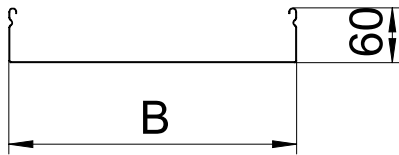

Type	Dim. L mm	Dim. B mm	Dim. H mm	Usable cross- section cm ²
GKS FL 610 FS	3000	100	60	58
GKS FL 615 FS	3000	150	60	88
GKS FL 620 FS	3000	200	60	118
GKS FL 630 FS	3000	300	60	178
GKS FL 640 FS	3000	400	60	238
GKS FL 650 FS	3000	500	60	298

Cable tray GKS GX 60

Type	Width mm	Metal thick- ness mm	Pack m	Weight kg/100 m	Item no.
GKS GX 610 FS	100	0.60	3	109.270	6480031
GKS GX 615 FS	150	0.70	3	154.960	6480032
GKS GX 620 FS	200	0.70	3	182.430	6480033
GKS GX 630 FS	300	1.00	3	339.120	6480034
GKS GX 640 FS	400	1.20	3	501.140	6480035
GKS GX 650 FS	500	1.20	3	595.340	6480036
GKS GX 610 FT	100	0.60	3	120.200	6483031
GKS GX 615 FT	150	0.70	3	170.280	6483032
GKS GX 620 FT	200	0.70	3	200.680	6483033
GKS GX 630 FT	300	1.00	3	373.030	6483034
GKS GX 640 FT	400	1.20	3	551.260	6483035
GKS GX 650 FT	500	1.20	3	654.880	6483036

GKS 60 GX = perforated cable tray system with 60 mm side height

Type	Dim. L mm	Dim. B mm	Dim. H mm	Dim. D mm	Usable cross- section cm ²
GKS GX 610 FS	3000	100	60	50	58
GKS GX 615 FS	3000	150	60	25	88
GKS GX 620 FS	3000	200	60	75	118
GKS GX 630 FS	3000	300	60	75	178
GKS GX 640 FS	3000	400	60	80	238
GKS GX 650 FS	3000	500	60	110	298



Dimensions

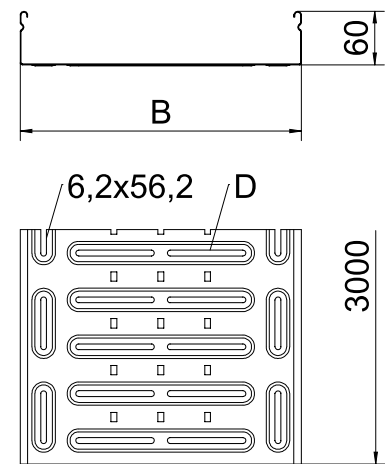

Cover

Type	Dim. B mm	Metal thick- ness mm	Length mm	Pack m	Weight kg/100 m	Item no.
GDRL 100 FS	100	0.60	3000	3	69.710	6480101
GDRL 150 FS	150	0.60	3000	3	93.260	6480102
GDRL 200 FS	200	0.60	3000	3	116.810	6480103
GDRL 300 FS	300	0.60	3000	3	163.910	6480104
GDRL 400 FS	400	0.70	3000	3	246.180	6480105
GDRL 500 FS	500	0.70	3000	3	301.130	6480106
GDRL 100 FT	100	0.60	3000	3	76.680	6483101
GDRL 150 FT	150	0.60	3000	3	102.580	6483102
GDRL 200 FT	200	0.60	3000	3	128.490	6483103
GDRL 300 FT	300	0.60	3000	3	180.300	6483104
GDRL 400 FT	400	0.70	3000	3	270.790	6483105
GDRL 500 FT	500	0.70	3000	3	331.240	6483106

Unperforated cover for cable trays for direct attachment.

When using covers outdoors, additional measures against the influence of wind must be taken.

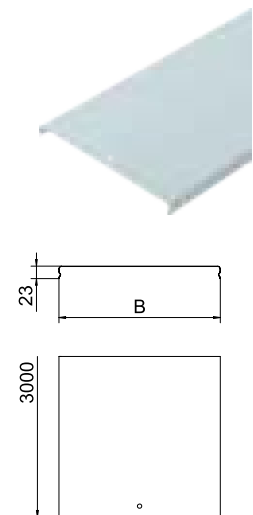

Barrier strip 60

Type	Dim. H mm	Metal thick- ness mm	Dim. L mm	Pack m	Weight kg/100 m	Item no.
GKSTSG 60 FS	60	0.75	3000	3	38.420	6480111

Barrier strip for separation of cables of different voltages or functions.

Including appropriate fastening material.

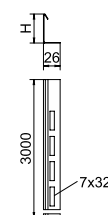

Straight connector GKSLVL 60

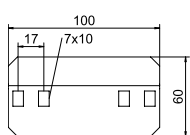

Type	Dim. H mm	Pack	Weight	Item no.
		Piece	kg/100 pc.	
GKSLVL 60 FS	60	20	8.000	6481340
GKSLVL 60 FT	60	20	10.520	6484331

Straight connector for connections of cable trays, fittings and barrier strips.
Including appropriate fastening material.

Angle connector 60

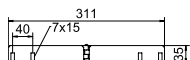

Type	Dim. H mm	Pack	Weight	Item no.
		Piece	kg/100 pc.	
GKSGO 60 FS	37	20	15.860	6481352

Angle connector for horizontal changes of direction of cable trays, fittings and barrier strips.
Including appropriate fastening material.

Adjustable connector 60

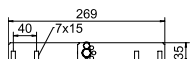

Type	Dim. H mm	Pack	Weight	Item no.
		Piece	kg/100 pc.	
GKSGV 60 FS	37	20	15.860	6481350

Adjustable connector for vertical changes of direction of cable trays and barrier strips.
Including appropriate fastening material.

Stop-end 60

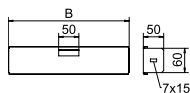

Type	Dim.		Pack Piece	Weight kg/100 pc.	Item no.
	H mm	B mm			
GKS TC 610 FS	60	100	1	15.930	6481271
GKS TC 615 FS	60	150	1	19.070	6481273
GKS TC 620 FS	60	200	1	22.210	6481275
GKS TC 630 FS	60	300	1	28.490	6481277
GKS TC 640 FS	60	400	1	34.770	6481279
GKS TC 650 FS	60	500	1	41.050	6481281

Stop-end to close cable trays of type GKS side height 60 mm.
Including appropriate fastening material.

Reduction, single-sided, two-part 60

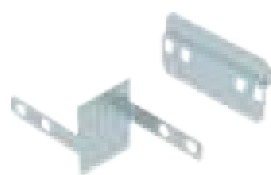

Type	Dim.		Pack Piece	Weight kg/100 pc.	Item no.
	H mm	B mm			
GKSRL 6 50 FS	60	50	1	20.850	6480871
GKSRL 6 100 FS	60	100	1	23.090	6480872
GKSRL 6 150 FS	60	150	1	25.330	6480873
GKSRL 6 200 FS	60	200	1	27.570	6480874
GKSRL 6 250 FS	60	250	1	30.310	6480875
GKSRL 6 300 FS	60	300	1	32.620	6480876
GKSRL 6 350 FS	60	350	1	34.920	6480877
GKSRL 6 400 FS	60	400	1	37.230	6480878

One-sided reducing bracket, 2-part for GKS... type cable trays with a side height of 60 mm.

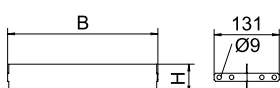

Reduction, central, two-part 60

Type	Dim. H mm	Dim. A mm	Pack Piece	Weight kg/100 pc.	Item no.
GKSRA 6 25 FS	60	25	1	19.790	6480841
GKSRA 6 50 FS	60	50	1	22.030	6480842
GKSRA 6 75 FS	60	75	1	24.270	6480843
GKSRA 6 100 FS	60	100	1	26.500	6480844
GKSRA 6 125 FS	60	125	1	28.740	6480845
GKSRA 6 150 FS	60	150	1	30.980	6480846
GKSRA 6 175 FS	60	175	1	33.210	6480847
GKSRA 6 200 FS	60	200	1	35.450	6480848

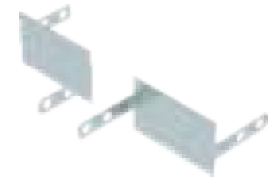

Central reducing bracket, 2-part for GKS... type cable trays with a side height of 60 mm.

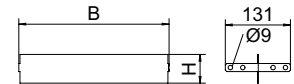

45° bend 60

Type	Side height mm	Dim. A mm	Dim. B mm	Pack Piece	Weight kg/100 pc.	Item no.
GKSB 45 610 FS	60	250	100	1	54.990	6480161
GKSB 45 615 FS	60	280	150	1	74.090	6480162
GKSB 45 620 FS	60	320	200	1	94.770	6480163
GKSB 45 630 FS	60	390	300	1	135.500	6480164
GKSB 45 640 FS	60	470	400	1	242.950	6480165
GKSB 45 650 FS	60	570	500	1	326.110	6480166
GKSB 45 610 FT	60	250	100	1	60.480	6483161
GKSB 45 615 FT	60	280	150	1	81.400	6483162
GKSB 45 620 FT	60	320	200	1	104.240	6483163
GKSB 45 630 FT	60	390	300	1	149.050	6483164
GKSB 45 640 FT	60	470	400	1	92.400	6483165
GKSB 45 650 FT	60	570	500	1	358.720	6483166

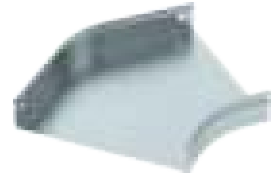

45° bend, horizontal, for all cable tray types of the series GKS... of 60 mm side height.

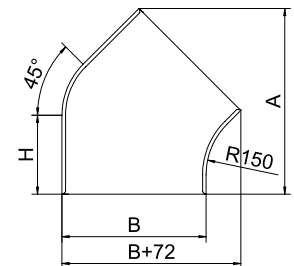

Cover for 45° bend, horizontal

Type	Dim. B mm	Dim. D mm	Pack Piece	Weight kg/100 pc.	Item no.
GKSDB 45 100 FS	100	8	1	25.500	6480191
GKSDB 45 150 FS	150	8	1	34.000	6480192
GKSDB 45 200 FS	200	8	1	46.750	6480193
GKSDB 45 300 FS	300	8	1	68.000	6480194
GKSDB 45 400 FS	400	8	1	102.000	6480195
GKSDB 45 500 FS	500	8	1	136.000	6480196
GKSDB 45 100 FT	100	8	1	28.050	6483191
GKSDB 45 150 FT	150	8	1	37.400	6483192
GKSDB 45 200 FT	200	8	1	51.420	6483193
GKSDB 45 300 FT	300	8	1	70.400	6483194
GKSDB 45 400 FT	400	8	1	112.200	6483195
GKSDB 45 500 FT	500	8	1	149.600	6483196

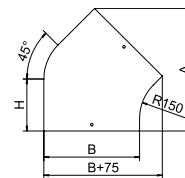

Lock-on cover for the 45° bend.



Side height 60 GKS

90° bend 60, horizontal

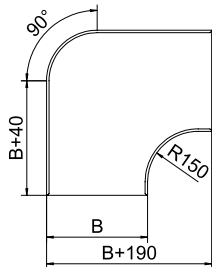

Type	Side height mm	Dim. B mm	Pack Piece	Weight kg/100 pc.	Item no.
GKSB 90 610 FS	60	100	1	72.800	6480121
GKSB 90 615 FS	60	150	1	97.260	6480122
GKSB 90 620 FS	60	200	1	124.860	6480123
GKSB 90 630 FS	60	300	1	189.480	6480124
GKSB 90 640 FS	60	400	1	317.440	6480125
GKSB 90 650 FS	60	500	1	427.210	6480126
GKSB 90 610 FT	60	100	1	80.080	6483121
GKSB 90 615 FT	60	150	1	106.900	6483122
GKSB 90 620 FT	60	200	1	137.340	6483123
GKSB 90 630 FT	60	300	1	208.420	6483124
GKSB 90 640 FT	60	400	1	349.180	6483125
GKSB 90 650 FT	60	500	1	469.930	6483126

90° bend, horizontal, for all cable tray types of the series GKS... of 60 mm side height.

Cover for 90° bend, horizontal

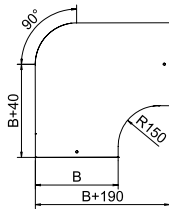

Type	Dim. B mm	Metal thickness mm	Pack Piece	Weight kg/100 pc.	Item no.
GKSDB 90 100 FS	100	1.00	1	36.550	6480151
GKSDB 90 150 FS	150	1.00	1	57.800	6480152
GKSDB 90 200 FS	200	1.00	1	81.600	6480153
GKSDB 90 300 FS	300	1.00	1	140.250	6480154
GKSDB 90 400 FS	400	1.00	1	213.350	6480155
GKSDB 90 500 FS	500	1.00	1	299.200	6480156

Lock-on cover for the 90° bend.

Add-on tee 60, with cover

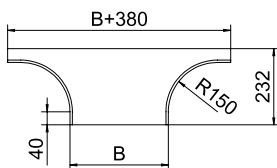

Type	Side height mm	Dim. B mm	Pack Piece	Weight kg/100 pc.	Item no.
GKSAA 610 FS	60	100	1	65.000	6480431
GKSAA 615 FS	60	150	1	80.000	6480432
GKSAA 620 FS	60	200	1	90.000	6480433
GKSAA 630 FS	60	300	1	125.000	6480434
GKSAA 640 FS	60	400	1	190.000	6480435
GKSAA 650 FS	60	500	1	260.000	6480436
GKSAA 610 FT	60	100	1	88.000	6483431
GKSAA 615 FT	60	150	1	88.000	6483432
GKSAA 620 FT	60	200	1	99.000	6483433
GKSAA 630 FT	60	300	1	137.500	6483434
GKSAA 640 FT	60	400	1	209.000	6483435
GKSAA 650 FT	60	500	1	286.000	6483436

Add-on tee with cover for all GKS... cable tray types of 60 mm side height.

90° vertical bend, rising 60

Type	Dim.	Dim.	Dim.	Pack	Weight	Item no.
	H	A	B			
	mm	mm	mm	Piece	kg/100 pc.	
GKSBV 90610S FS	60	250	100	1	106.700	6480201
GKSBV 90615S FS	60	250	150	1	119.320	6480202
GKSBV 90620S FS	60	250	200	1	131.950	6480203
GKSBV 90630S FS	60	250	300	1	157.190	6480204
GKSBV 90640S FS	60	250	400	1	182.440	6480205
GKSBV 90650S FS	60	250	500	1	207.680	6480206
GKSBV 90610S FT	60	255	100	1	117.370	6483201
GKSBV 90615S FT	60	255	150	1	131.200	6483202
GKSBV 90620S FT	60	255	200	1	145.140	6483203
GKSBV 90630S FT	60	255	300	1	172.900	6483204
GKSBV 90640S FT	60	255	400	1	200.680	6483205
GKSBV 90650S FT	60	255	300	1	227.700	6483206

90° rising vertical bend, for all GKS... cable tray types of 60 mm side height.

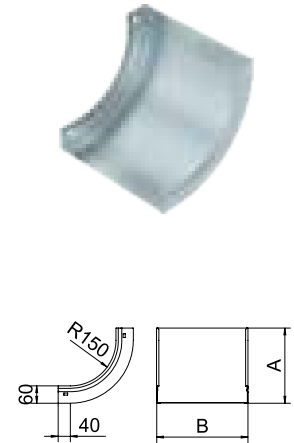

90° vertical bend, falling 60

Type	Dim.	Dim.	Dim.	Pack	Weight	Item no.
	H	A	B			
	mm	mm	mm	Piece	kg/100 pc.	
GKSBV 90610F FS	60	255	100	1	101.470	6480281
GKSBV 90615F FS	60	255	150	1	111.420	6480282
GKSBV 90620F FS	60	255	200	1	121.380	6480283
GKSBV 90630F FS	60	255	300	1	141.280	6480284
GKSBV 90640F FS	60	255	400	1	161.070	6480285
GKSBV 90650F FS	60	255	500	1	180.940	6480286
GKSBV 90610F FT	60	255	100	1	111.610	6483281
GKSBV 90615F FT	60	255	150	1	122.500	6483282
GKSBV 90620F FT	60	255	200	1	133.510	6483283
GKSBV 90630F FT	60	255	300	1	155.400	6483284
GKSBV 90640F FT	60	255	400	1	177.170	6483285
GKSBV 90650F FT	60	255	500	1	199.030	6483286

90° vertical bend, falling, for all GKS... cable tray types of 60 mm side height.

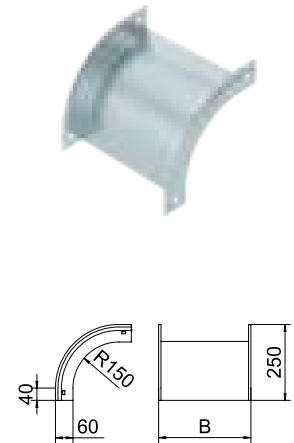

Cover for horizontal tee

Type	Dim.	Metal	Pack	Weight	Item no.
	B	thick- ness			
	mm	mm	Piece	kg/100 pc.	
GKSDT 100 FS	100	1.00	1	46.750	6480491
GKSDT 150 FS	150	1.00	1	63.750	6480492
GKSDT 200 FS	200	1.00	1	93.500	6480493
GKSDT 300 FS	300	1.00	1	137.700	6480494
GKSDT 400 FS	400	1.00	1	255.000	6480495
GKSDT 500 FS	500	1.00	1	323.000	6480496
GKSDT 100 FT	100	1.00	1	51.420	6483491
GKSDT 150 FT	150	1.00	1	70.120	6483492
GKSDT 200 FT	200	1.00	1	102.850	6483493
GKSDT 300 FT	300	1.00	1	151.470	6483494
GKSDT 400 FT	400	1.00	1	280.500	6483495
GKSDT 500 FT	500	1.00	1	355.300	6483496

Cover for horizontal tee for GKS... cable tray types with all side heights.

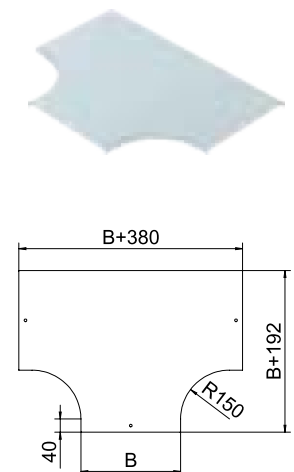

T branch piece, horizontal 60

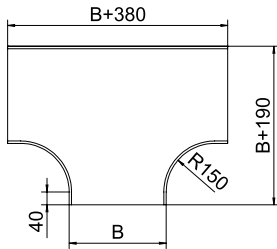

Type	Side height mm	Dim. B mm	Pack Piece	Weight kg/100 pc.	Item no.
GKST 610 FS	60	100	1	107.540	6480461
GKST 615 FS	60	150	1	135.560	6480462
GKST 620 FS	60	200	1	166.730	6480463
GKST 630 FS	60	300	1	238.480	6480464
GKST 640 FS	60	400	1	316.780	6480465
GKST 650 FS	60	500	1	508.490	6480466
GKST 610 FT	60	100	1	118.290	6483461
GKST 615 FT	60	150	1	149.110	6483462
GKST 620 FT	60	200	1	183.400	6483463
GKST 630 FT	60	300	1	262.320	6483464
GKST 640 FT	60	400	1	348.450	6483465
GKST 650 FT	60	500	1	559.330	6483466

Horizontal tee for all GKS... cable tray types with a side height of 60 mm.

Cover for cross-over

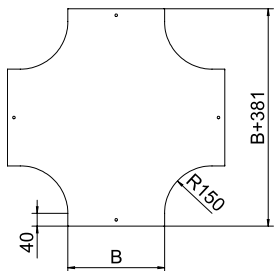

Type	Dim. A mm	Dim. B mm	Dim. D mm	Pack Piece	Weight kg/100 pc.	Item no.
GKSDK 100 FS	480	100	8	1	80.750	6480531
GKSDK 150 FS	530	150	8	1	107.100	6480532
GKSDK 200 FS	580	200	8	1	144.500	6480533
GKSDK 300 FS	680	300	8	1	216.750	6480534
GKSDK 400 FS	780	400	8	1	297.500	6480535
GKSDK 500 FS	880	500	8	1	382.500	6480536
GKSDK 100 FT	480	100	8	1	88.820	6483531
GKSDK 150 FT	530	150	8	1	117.800	6483532
GKSDK 200 FT	580	200	8	1	158.900	6483533
GKSDK 300 FT	680	300	8	1	238.420	6483534
GKSDK 400 FT	780	400	8	1	327.200	6483535
GKSDK 500 FT	880	500	8	1	420.000	6483536

Cover for cross-over fitting for GKS... cable tray types with all side heights.

Cross-over 60

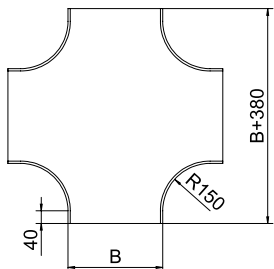

Type	Side height mm	Dim. B mm	Pack Piece	Weight kg/100 pc.	Item no.
GKSK 610 FS	60	100	1	175.600	6480501
GKSK 615 FS	60	150	1	171.320	6480502
GKSK 620 FS	60	200	1	206.040	6480503
GKSK 630 FS	60	300	1	284.920	6480504
GKSK 640 FS	60	400	1	459.390	6480505
GKSK 650 FS	60	500	1	589.380	6480506
GKSK 610 FT	60	100	1	193.160	6483501
GKSK 615 FT	60	150	1	226.600	6483502
GKSK 620 FT	60	200	1	226.640	6483503
GKSK 630 FT	60	300	1	313.410	6483504
GKSK 640 FT	60	400	1	614.900	6483505
GKSK 650 FT	60	500	1	647.900	6483506

Horizontal cross-over for all GKS... cable tray types of 60 mm side height.

Cover for 90° vertical bend, rising

Type	Side height mm	Dim. B mm	Pack Piece	Weight kg/100 pc.	Item no.
GKSDBV 90100S FS	190	100	1	23.800	6480231
GKSDBV 90150S FS	190	150	1	34.850	6480232
GKSDBV 90200S FS	190	200	1	43.350	6480233
GKSDBV 90300S FS	190	300	1	63.750	6480234
GKSDBV 90400S FS	190	400	1	87.550	6480235
GKSDBV 90500S FS	190	500	1	107.950	6480236
GKSDBV 90100S FT	190	100	1	26.100	6483231
GKSDBV 90150S FT	190	150	1	38.330	6483232
GKSDBV 90200S FT	190	200	1	47.680	6483233
GKSDBV 90300S FT	190	300	1	70.120	6483234
GKSDBV 90400S FT	190	400	1	96.300	6483235
GKSDBV 90500S FT	190	500	1	118.740	6483236

Cover for 90° vertical bend (rising) fitting for GKS... cable tray types

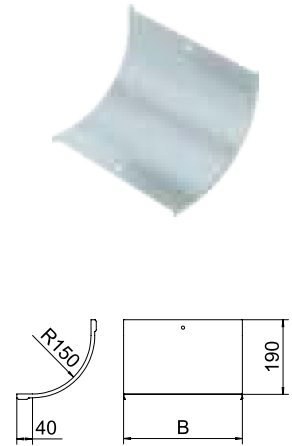

Cover for 90° vertical bend, falling

Type	Dim. B mm	Dim. A mm	Dim. D mm	Dim. R mm	Pack Piece	Weight kg/100 pc.	Item no.
GKSDBV 90100F FS	100	250	8	209	1	32.720	6480311
GKSDBV 90150F FS	150	250	8	209	1	46.000	6480312
GKSDBV 90200F FS	200	250	8	209	1	58.280	6480313
GKSDBV 90300F FS	300	250	8	209	1	83.840	6480314
GKSDBV 90400F FS	400	250	8	209	1	136.740	6480315
GKSDBV 90500F FS	500	250	8	209	1	168.690	6480316
GKSDBV 90100F FT	100	250	8	209	1	35.990	6483311
GKSDBV 90150F FT	150	250	8	209	1	50.000	6483312
GKSDBV 90200F FT	200	250	8	209	1	64.100	6483313
GKSDBV 90300F FT	300	250	8	209	1	92.220	6483314
GKSDBV 90400F FT	400	250	8	209	1	120.340	6483315
GKSDBV 90500F FT	500	250	8	209	1	148.440	6483316

Cover for 90° vertical bend (falling) fitting with 60 mm side height for GKS... cable tray types

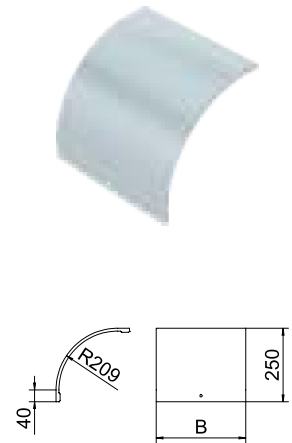

Side height 110 GKS

Cable tray GKS FL 100



Type	Side height mm	Width mm	Metal thick- ness mm	Pack m	Weight kg/100 m	Item no.
GKS FL 115 FS	100	150	0.90	3	227.340	6480022
GKS FL 120 FS	100	200	0.90	3	323.420	6480023
GKS FL 130 FS	100	300	1.00	3	401.920	6480024
GKS FL 140 FS	100	400	1.20	3	576.500	6480025
GKS FL 150 FS	100	500	1.20	3	670.700	6480026

GKS 100 FL = unperforated cable tray system with 100 mm side height

Dimensions

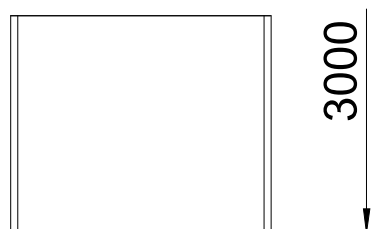
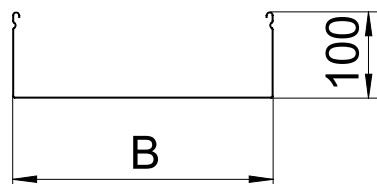

Type	Dim. L mm	Dim. B mm	Dim. H mm	Usable cross- section cm ²
GKS FL 115 FS	3000	150	100	148
GKS FL 120 FS	3000	200	100	198
GKS FL 130 FS	3000	300	100	298
GKS FL 140 FS	3000	400	100	398
GKS FL 150 FS	3000	500	100	498

GX cable tray, perforated

Type	Side height mm	Width mm	Metal thickness mm	Pack m	Weight kg/100 m	Item no.
GKS GX 115 FS	100	150	0.90	3	227.340	6480052
GKS GX 120 FS	100	200	0.90	3	323.420	6480053
GKS GX 130 FS	100	300	1.00	3	401.920	6480054
GKS GX 140 FS	100	400	1.20	3	576.500	6480055
GKS GX 150 FS	100	500	1.20	3	670.700	6480056
GKS GX 115 FT	100	150	0.90	3	312.590	6483052
GKS GX 120 FT	100	200	0.90	3	355.760	6483053
GKS GX 130 FT	100	300	1.00	3	441.670	6483054
GKS GX 140 FT	100	400	1.20	3	633.520	6483055
GKS GX 150 FT	100	500	1.20	3	737.030	6483056



GKS 100 GX = perforated cable tray system with 100 mm side height

Type	Dim. L mm	Dim. B mm	Dim. H mm	Dim. D mm	Usable cross-section cm ²
GKS GX 115 FS	3000	150	100	25	148
GKS GX 120 FS	3000	200	100	75	198
GKS GX 130 FS	3000	300	100	75	298
GKS GX 140 FS	3000	400	100	80	398
GKS GX 150 FS	3000	500	100	110	498

Dimensions

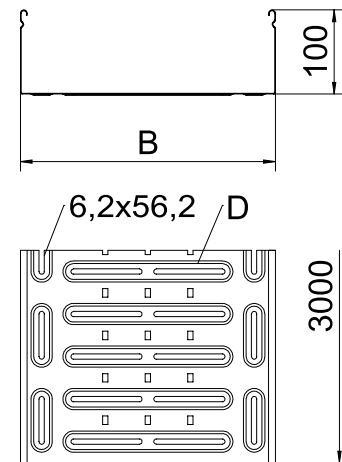

Cover

Type	Dim. B mm	Metal thickness mm	Length mm	Pack m	Weight kg/100 m	Item no.
GDRL 100 FS	100	0.60	3000	3	69.710	6480101
GDRL 150 FS	150	0.60	3000	3	93.260	6480102
GDRL 200 FS	200	0.60	3000	3	116.810	6480103
GDRL 300 FS	300	0.60	3000	3	163.910	6480104
GDRL 400 FS	400	0.70	3000	3	246.180	6480105
GDRL 500 FS	500	0.70	3000	3	301.130	6480106
GDRL 100 FT	100	0.60	3000	3	76.680	6483101
GDRL 150 FT	150	0.60	3000	3	102.580	6483102
GDRL 200 FT	200	0.60	3000	3	128.490	6483103
GDRL 300 FT	300	0.60	3000	3	180.300	6483104
GDRL 400 FT	400	0.70	3000	3	270.790	6483105
GDRL 500 FT	500	0.70	3000	3	331.240	6483106

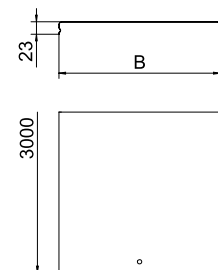

Unperforated cover for cable trays for direct attachment.

When using covers outdoors, additional measures against the influence of wind must be taken.

Barrier strip 100

Type	Dim. H mm	Metal thickness mm	Dim. L mm	Pack m	Weight kg/100 m	Item no.
GKSTSG 100 FS	100	0.60	3000	3	57.260	6480113

Barrier strip for separation of cables of different voltages or functions.

Including appropriate fastening material.

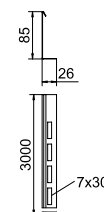

Side height 110 GKS

End closure plate 100

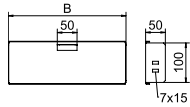

Type	Dim.		Pack Piece	Weight kg/100 pc.	Item no.
	H mm	B mm			
GKS TC 115 FS	100	150	1	27.770	6481295
GKS TC 120 FS	100	200	1	32.640	6481297
GKS TC 130 FS	100	300	1	42.370	6481299
GKS TC 140 FS	100	400	1	52.100	6481301
GKS TC 150 FS	100	500	1	61.840	6481303

Stop-end to close cable trays of type GKS with side height 100 mm.
Including appropriate fastening material.

Straight connector 100

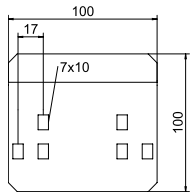

Type	Height mm	Pack Piece	Weight kg/100 pc.	Item no.
GKSLVL 100 FT	100	20	14.664	6484335

Straight connector for connections of cable trays, fittings and barrier strips.
Including appropriate fastening material.

90° bend 100, horizontal

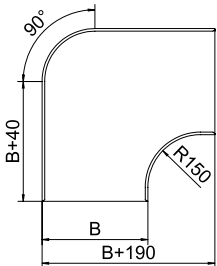

Type	Side height mm	Dim. B mm	Pack Piece	Weight kg/100 pc.	Item no.
GKSB 90 120 FS	100	200	1	150.650	6480143
GKSB 90 130 FS	100	300	1	220.290	6480144
GKSB 90 140 FS	100	400	1	353.280	6480145
GKSB 90 150 FS	100	500	1	468.080	6480146
GKSB 90 115 FT	100	150	1	132.000	6483142
GKSB 90 120 FT	100	200	1	165.710	6483143
GKSB 90 130 FT	100	300	1	242.000	6483144
GKSB 90 140 FT	100	400	1	363.280	6483145
GKSB 90 150 FT	100	500	1	514.800	6483146

90° bend, horizontal, for all cable tray types of the series GKS... of 100 mm side height.

Cover for 90° bend, horizontal

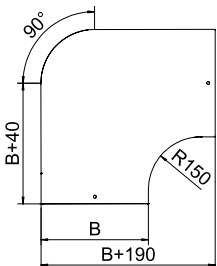

Type	Dim. B mm	Metal thickness mm	Pack Piece	Weight kg/100 pc.	Item no.
GKSDB 90 150 FS	150	1.00	1	57.800	6480152
GKSDB 90 200 FS	200	1.00	1	81.600	6480153
GKSDB 90 300 FS	300	1.00	1	140.250	6480154
GKSDB 90 400 FS	400	1.00	1	213.350	6480155
GKSDB 90 500 FS	500	1.00	1	299.200	6480156
GKSDB 90 100 FT	100	1.00	1	40.200	6483151
GKSDB 90 150 FT	150	1.00	1	63.580	6483152
GKSDB 90 200 FT	200	1.00	1	89.760	6483153
GKSDB 90 300 FT	300	1.00	1	154.270	6483154
GKSDB 90 400 FT	400	1.00	1	234.680	6483155
GKSDB 90 500 FT	500	1.00	1	329.120	6483156

Lock-on cover for the 90° bend.

45° bend 100

Type	Side height mm	Dim. A mm	Dim. B mm	Pack Piece	Weight kg/100 pc.	Item no.
GKSB 45 115 FS	100	280	150	1	84.080	6480182
GKSB 45 120 FS	100	320	200	1	108.870	6480183
GKSB 45 130 FS	100	390	300	1	151.680	6480184
GKSB 45 140 FS	100	470	400	1	261.220	6480185
GKSB 45 150 FS	100	570	500	1	346.490	6480186
GKSB 45 115 FT	100	280	150	1	166.100	6483182
GKSB 45 120 FT	100	320	200	1	119.750	6483183
GKSB 45 130 FT	100	390	300	1	287.100	6483184
GKSB 45 140 FT	100	470	400	1	227.700	6483185
GKSB 45 150 FT	100	570	500	1	381.130	6483186

45° bend, horizontal, for all cable tray types of the series GKS... of 100 mm side height.

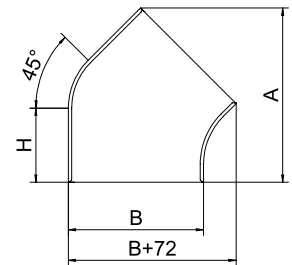
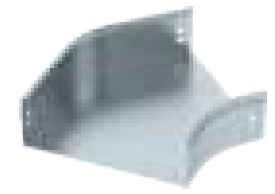

Cover for 45° bend, horizontal

Type	Dim. B mm	Dim. D mm	Pack Piece	Weight kg/100 pc.	Item no.
GKSDB 45 100 FS	100	8	1	25.500	6480191
GKSDB 45 150 FS	150	8	1	34.000	6480192
GKSDB 45 200 FS	200	8	1	46.750	6480193
GKSDB 45 300 FS	300	8	1	68.000	6480194
GKSDB 45 400 FS	400	8	1	102.000	6480195
GKSDB 45 500 FS	500	8	1	136.000	6480196
GKSDB 45 150 FT	150	8	1	37.400	6483192
GKSDB 45 200 FT	200	8	1	51.420	6483193
GKSDB 45 300 FT	300	8	1	70.400	6483194
GKSDB 45 400 FT	400	8	1	112.200	6483195
GKSDB 45 500 FT	500	8	1	149.600	6483196

Lock-on cover for the 45° bend.

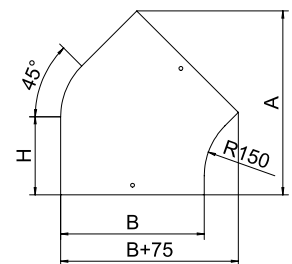

90° vertical bend, rising, 100

Type	Dim. H mm	Dim. A mm	Dim. B mm	Pack Piece	Weight kg/100 pc.	Item no.
GKSBV 90115S FS	100	295	150	1	163.810	6480222
GKSBV 90120S FS	100	295	200	1	178.420	6480223
GKSBV 90130S FS	100	295	300	1	207.660	6480224
GKSBV 90140S FS	100	295	400	1	236.890	6480225
GKSBV 90150S FS	100	295	500	1	266.120	6480226
GKSBV 90115S FT	100	295	150	1	179.300	6483222
GKSBV 90120S FT	100	295	200	1	195.800	6483223
GKSBV 90130S FT	100	295	300	1	227.700	6483224
GKSBV 90140S FT	100	295	400	1	259.600	6483225
GKSBV 90150S FT	100	295	500	1	292.600	6483226

90° rising vertical bend, for all GKS... cable tray types of 100 mm side height.

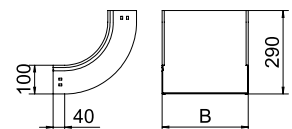
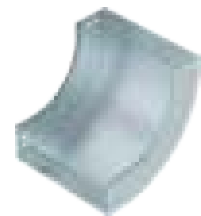

Cover for 90° vertical bend, rising

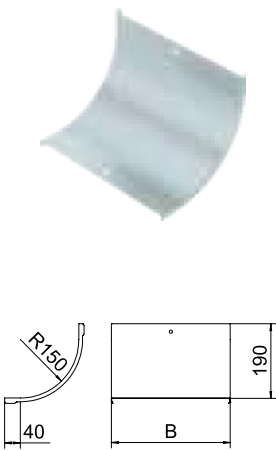

Type	Side height mm	Dim. B mm	Pack Piece	Weight kg/100 pc.	Item no.
GKSDBV 90100S FS	190	100	1	23.800	6480231
GKSDBV 90150S FS	190	150	1	34.850	6480232
GKSDBV 90200S FS	190	200	1	43.350	6480233
GKSDBV 90300S FS	190	300	1	63.750	6480234
GKSDBV 90400S FS	190	400	1	87.550	6480235
GKSDBV 90500S FS	190	500	1	107.950	6480236
GKSDBV 90100S FT	190	100	1	26.100	6483231
GKSDBV 90150S FT	190	150	1	38.330	6483232
GKSDBV 90200S FT	190	200	1	47.680	6483233
GKSDBV 90300S FT	190	300	1	70.120	6483234
GKSDBV 90400S FT	190	400	1	96.300	6483235
GKSDBV 90500S FT	190	500	1	118.740	6483236

Cover for 90° vertical bend (rising) fitting for GKS... cable tray types

90° vertical bend, falling 100

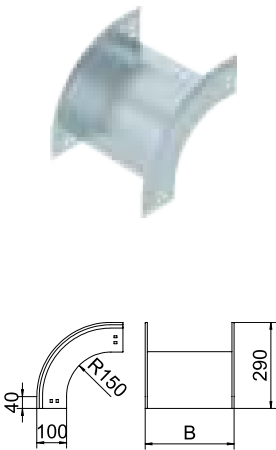

Type	Dim. H mm	Dim. A mm	Dim. B mm	Pack Piece	Weight kg/100 pc.	Item no.
GKSBV 90115F FS	100	295	150	1	150.000	6480302
GKSBV 90120F FS	100	295	200	1	159.960	6480303
GKSBV 90130F FS	100	295	300	1	179.860	6480304
GKSBV 90140F FS	100	295	400	1	199.650	6480305
GKSBV 90150F FS	100	295	500	1	219.520	6480306
GKSBV 90115F FT	100	295	150	1	165.000	6483302
GKSBV 90120F FT	100	295	200	1	175.950	6483303
GKSBV 90130F FT	100	295	300	1	196.900	6483304
GKSBV 90140F FT	100	295	400	1	219.610	6483305
GKSBV 90150F FT	100	295	500	1	241.470	6483306

90° vertical bend, falling, for all GKS... cable tray types of 100 mm side height.

Cover for 90° vertical bend 100, falling

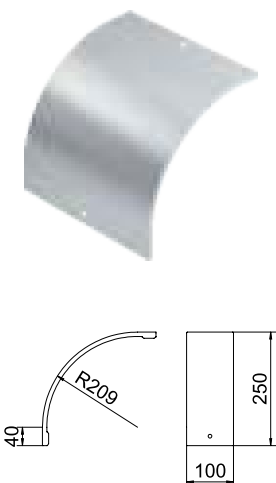

Type	Dim. B mm	Dim. A mm	Dim. D mm	Dim. R mm	Pack Piece	Weight kg/100 pc.	Item no.
GKSDBV 90150F FS	150	290	8	250	1	52.540	6480332
GKSDBV 90200F FS	200	290	8	250	1	67.300	6480333
GKSDBV 90300F FS	300	290	8	250	1	96.810	6480334
GKSDBV 90400F FS	400	290	8	250	1	157.910	6480335
GKSDBV 90500F FS	500	290	8	250	1	194.810	6480336
GKSDBV 90150F FT	150	290	8	250	1	57.200	6483332
GKSDBV 90200F FT	200	290	8	250	1	74.040	6483333
GKSDBV 90300F FT	300	290	8	250	1	105.600	6483334
GKSDBV 90400F FT	400	290	8	250	1	173.700	6483335
GKSDBV 90500F FT	500	290	8	250	1	213.400	6483336

Cover for 90° vertical bend (falling) fitting with 100 mm side height for GKS... cable tray types

Add-on tee 100, with cover

Type	Side height mm	Dim. B mm	Pack Piece	Weight kg/100 pc.	Item no.
GKSAA 115 FS	100	150	1	100.000	6480451
GKSAA 120 FS	100	200	1	115.000	6480452
GKSAA 130 FS	100	300	1	145.000	6480453
GKSAA 140 FS	100	400	1	230.000	6480454
GKSAA 150 FS	100	500	1	295.000	6480455
GKSAA 115 FT	100	150	1	110.000	6483451
GKSAA 120 FT	100	200	1	126.500	6483452
GKSAA 130 FT	100	300	1	159.500	6483453
GKSAA 140 FT	100	400	1	253.000	6483454
GKSAA 150 FT	100	500	1	324.500	6483455

Add-on tee with cover for all GKS... cable tray types of 100 mm side height.

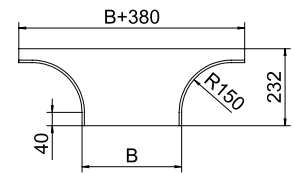
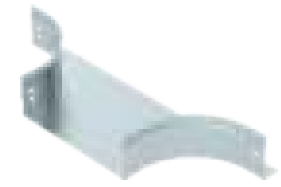

T branch piece, horizontal 100

Type	Side height mm	Dim. B mm	Pack Piece	Weight kg/100 pc.	Item no.
GKST 115 FS	100	150	1	164.580	6480482
GKST 120 FS	100	200	1	197.010	6480483
GKST 130 FS	100	300	1	271.270	6480484
GKST 140 FS	100	400	1	352.090	6480485
GKST 150 FS	100	500	1	546.310	6480486
GKST 115 FT	100	150	1	181.030	6483482
GKST 120 FT	100	200	1	216.700	6483483
GKST 130 FT	100	300	1	298.000	6483484
GKST 140 FT	100	400	1	387.200	6483485
GKST 150 FT	100	500	1	600.600	6483486

Horizontal tee for all GKS... cable tray types with a side height of 100 mm.

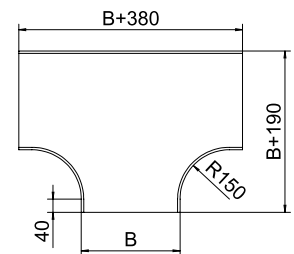

Cover for horizontal tee

Type	Dim. B mm	Metal thick- ness mm	Pack Piece	Weight kg/100 pc.	Item no.
GKSDT 100 FS	100	1.00	1	46.750	6480491
GKSDT 150 FS	150	1.00	1	63.750	6480492
GKSDT 200 FS	200	1.00	1	93.500	6480493
GKSDT 300 FS	300	1.00	1	137.700	6480494
GKSDT 400 FS	400	1.00	1	255.000	6480495
GKSDT 500 FS	500	1.00	1	323.000	6480496
GKSDT 100 FT	100	1.00	1	51.420	6483491
GKSDT 150 FT	150	1.00	1	70.120	6483492
GKSDT 200 FT	200	1.00	1	102.850	6483493
GKSDT 300 FT	300	1.00	1	151.470	6483494
GKSDT 400 FT	400	1.00	1	280.500	6483495
GKSDT 500 FT	500	1.00	1	355.300	6483496

Cover for horizontal tee for GKS... cable tray types with all side heights.

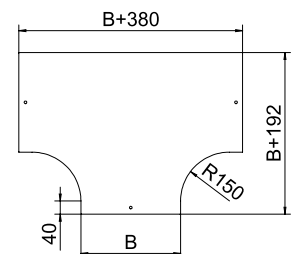

Side height 110 GKS

100 cross-over

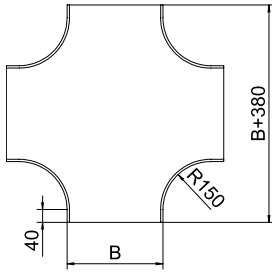

Type	Side height mm	Dim. B mm	Pack Piece	Weight kg/100 pc.	Item no.
GKSK 115 FS	100	150	1	202.840	6480522
GKSK 120 FS	100	200	1	237.560	6480523
GKSK 130 FS	100	300	1	316.440	6480524
GKSK 140 FS	100	400	1	490.910	6480525
GKSK 150 FS	100	500	1	620.900	6480526
GKSK 115 FT	100	150	1	222.200	6483522
GKSK 120 FT	100	200	1	260.700	6483523
GKSK 130 FT	100	300	1	347.000	6483524
GKSK 140 FT	100	400	1	539.000	6483525
GKSK 150 FT	100	500	1	682.000	6483526

Horizontal cross-over for all GKS... cable tray types with a side height of 100 mm.

Cover for cross-over

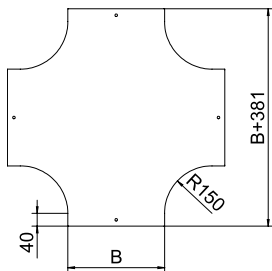

Type	Dim. A mm	Dim. B mm	Dim. D mm	Pack Piece	Weight kg/100 pc.	Item no.
GKSDK 150 FS	530	150	8	1	107.100	6480532
GKSDK 200 FS	580	200	8	1	144.500	6480533
GKSDK 300 FS	680	300	8	1	216.750	6480534
GKSDK 400 FS	780	400	8	1	297.500	6480535
GKSDK 500 FS	880	500	8	1	382.500	6480536
GKSDK 150 FT	530	150	8	1	117.800	6483532
GKSDK 200 FT	580	200	8	1	158.900	6483533
GKSDK 300 FT	680	300	8	1	238.420	6483534
GKSDK 400 FT	780	400	8	1	327.200	6483535
GKSDK 500 FT	880	500	8	1	420.000	6483536

Cover for cross-over fitting for GKS... cable tray types with all side heights.

Reduction, central, two-part 100

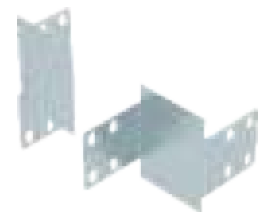

Type	Dim. H mm	Dim. A mm	Pack Piece	Weight kg/100 pc.	Item no.
GKSRA 1 25 FS	100	25	1	30.230	6480861
GKSRA 1 50 FS	100	50	1	34.150	6480862
GKSRA 1 75 FS	100	75	1	38.080	6480863
GKSRA 1 100 FS	100	100	1	42.000	6480864
GKSRA 1 125 FS	100	125	1	45.920	6480865
GKSRA 1 150 FS	100	150	1	49.840	6480866
GKSRA 1 175 FS	100	175	1	53.760	6480867
GKSRA 1 200 FS	100	200	1	57.680	6480868

Central reducing bracket, 2-part for GKS... type cable trays with a side height of 100 mm.

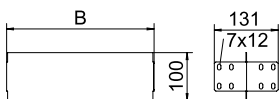

Reduction, single-sided, two-part 100



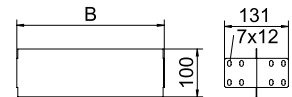

Type	Dim.	Dim.	Dim.	Pack Piece	Weight kg/100 pc.	Item no.
	H mm	B mm	A mm			
GKSRL 100 150 FS	100	150	100	1	38.520	6480895
GKSRL 100 50 FS	100	50	100	1	30.760	6480897
GKSRL 100 100 FS	100	100	100	1	34.600	6480899
GKSRL 100 200 FS	100	200	100	1	42.440	6480901
GKSRL 100 250 FS	100	250	100	1	45.500	6480903
GKSRL 100 300 FS	100	300	100	1	49.300	6480905
GKSRL 100 350 FS	100	350	100	1	53.110	6480907
GKSRL 100 400 FS	100	400	100	1	56.920	6480909

One-sided reducing bracket, 2-part for GKS... type cable trays with a side height of 100 mm.





Mesh cable tray systems

	GR side height 55	122
	GR side height 105	123
	Accessories for side height 55, 105 mm	124
	Heavy-duty mesh cable tray	128
	Mounting systems	132



Mesh cable tray GR 55

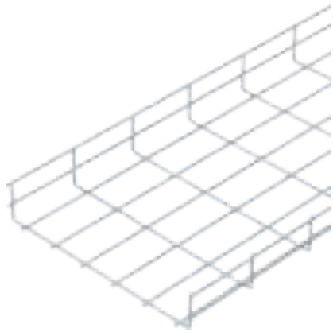

Type	Width mm	Wire Ø mm	Pack m	Weight kg/100 m	Item no.
GR 55 100 FT	100	3.9	3	74.633	6000118
GR 55 150 FT	150	3.9	3	88.833	6000150
GR 55 200V FT	200	4.8	3	154.967	6005039
GR 55 300 FT	300	4.8	3	198.000	6000304
GR 55 400 FT	400	4.8	3	241.033	6000401
GR 55 500 FT	500	4.8	3	283.333	6000509
GR 55 600 FT	600	4.8	3	326.667	6000606
GR 55 050 G	50	3.9	3	66.333	6004806
GR 55 100 G	100	3.9	3	70.867	6004814
GR 55 150 G	150	3.9	3	84.367	6004822
GR 55 200V G	200	4.8	3	148.600	6004830
GR 55 300 G	300	4.8	3	189.867	6004849
GR 55 400 G	400	4.8	3	231.133	6004857
GR 55 500 G	500	4.8	3	272.333	6004865
GR 55 600 G	600	4.8	3	313.700	6000770
GR 55 050 A2	50	3.8	1	66.267	6000904
GR 55 100 A2	100	3.8	3	70.867	6000908
GR 55 150 A2	150	3.8	3	84.367	6000912
GR 55 200V A2	200	4.8	3	148.600	6000916
GR 55 300 A2	300	4.8	3	189.867	6000924
GR 55 400 A2	400	4.8	3	231.133	6000932
GR 55 500 A2	500	4.8	3	272.433	6000940
GR 55 600 A2	600	4.8	3	313.700	6000959

Mesh cable tray made of spot-welded steel wire of side height 55 mm.

Dimensions

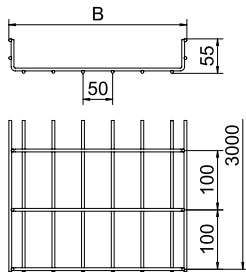

Load

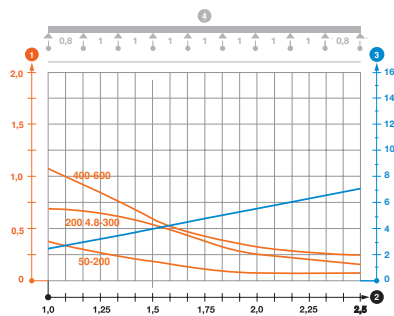

Type	Length mm	Dim. B mm	Wire Ø mm	Usable cross- section cm ²
GR 55 100 G	3000	100	58	40
GR 55 150 G	3000	150	58	63
GR 55 200V G	3000	200	87	
GR 55 300 G	3000	300	58	129
GR 55 400 G	3000	400	58	175
GR 55 500 G	3000	500	58	220
GR 55 600 G	3000	600	58	265

Type	1.0 m 1.5 m 2.0 m 2.5 m			
	kN/m	kN/m	kN/m	kN/m
GR 55 50 FT	0.35	0.2	0.1	0.1
GR 55 100 FT	0.35	0.2	0.1	0.1
GR 55 150 FT	0.35	0.2	0.1	0.1
GR 55 200V FT	0.7	0.55	0.25	0.2
GR 55 300 FT	0.7	0.55	0.25	0.2
GR 55 400 FT	1.1	0.6	0.3	0.25
GR 55 500 FT	1.1	0.6	0.3	0.25
GR 55 600 FT	1.1	0.6	0.3	0.25

Load diagram, mesh cable tray, type GR 55

- 1 Permitted cable tray/ladder load in kN/m without man load
- 2 Support width in m
- 3 Rail bend in mm at permitted kN/m
- 4 Load scheme during testing
- Load curve with cable tray/ladder width in mm
- Strut bend curve according to support width

Mesh cable tray GR 105

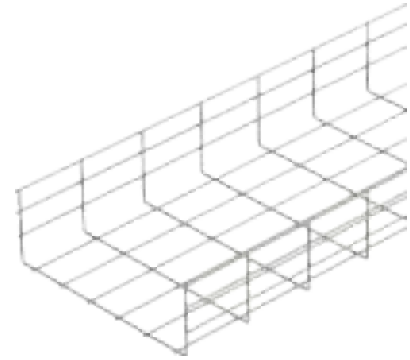

Type	Wire		Pack	Weight	Item no.
	Width	Ø			
	mm	mm	m	kg/100 m	
GR 105 100 A2	100	3.8	3	97.833	6002811
GR 105 150 A2	150	3.8	3	111.333	6002815
GR 105 200 A2	200	4.8	3	189.867	6002749
GR 105 300 A2	300	4.8	3	230.333	6002862
GR 105 400 A2	400	4.8	3	272.433	6002870
GR 105 500 A2	500	4.8	3	313.700	6002874
GR 105 600 A2	600	4.8	3	355.000	6002878
GR 105 100 G	100	3.9	3	97.833	6002838
GR 105 150 G	150	3.9	3	111.333	6002803
GR 105 200 G	200	4.8	3	189.867	6002846
GR 105 300 G	300	4.8	3	231.133	6002854
GR 105 400 G	400	4.8	3	272.433	6002927
GR 105 500 G	500	4.8	3	313.700	6002935
GR 105 600 G	600	4.8	3	355.000	6002943
GR 105 100 FT	100	3.9	3	103.033	6003109
GR 105 150 FT	150	3.9	3	117.267	6003168
GR 105 200 FT	200	4.8	3	198.000	6003206
GR 105 300 FT	300	4.8	3	241.033	6003303
GR 105 400 FT	400	4.8	3	284.100	6003400
GR 105 500 FT	500	4.8	3	327.133	6003508
GR 105 600 FT	600	4.8	3	370.200	6003605

Mesh cable tray made of spot-welded steel wire of side height 105 mm.

Type	Length	Dim. B	Usable
			cross-section
	mm	mm	cm ²
GR 105 100 A2	3000	100	82
GR 105 150 FT	3000	150	130
GR 105 200 FT	3000	200	175
GR 105 300 FT	3000	300	268
GR 105 400 A2	3000	400	363
GR 105 500 A2	3000	500	459
GR 105 600 A2	3000	600	554

Dimensions

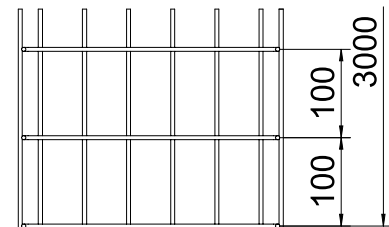
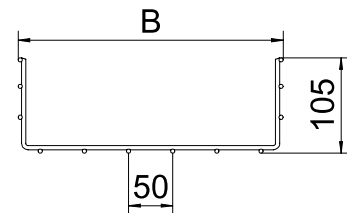

Load

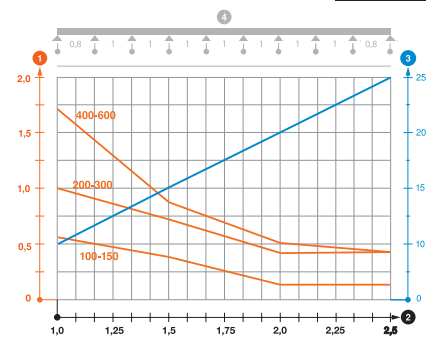

Type	1.0 m	1.5 m	2.0 m	2.5 m
	kN/m	kN/m	kN/m	kN/m
GR 105 100 A2	0.55	0.35	0.15	0.15
GR 105 150 A2	0.55	0.35	0.15	0.15
GR 105 200 A2	1	0.7	0.4	0.4
GR 105 300 A2	1	0.7	0.4	0.4
GR 105 400 A2	1.6	0.8	0.5	0.4
GR 105 500 A2	1.7	0.8	0.5	0.4
GR 105 600 A2	1.7	0.8	0.5	0.4

Load diagram, mesh cable tray, type GR 105

- 1 Permitted cable tray/ladder load in kN/m without man load
- 2 Support width in m
- 3 Rail bend in mm at permitted kN/m
- 4 Load scheme during testing
- Load curve with cable tray/ladder width in mm
- Strut bend curve according to support width

Joint connector GSV 34

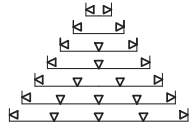
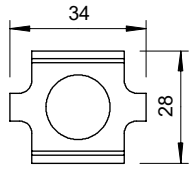

Type

Type	Pack Piece	Weight kg/100 pc.	Item no.
GSV 34 G	20	3.155	6016596
GSV 34 FT	20	3.150	6016634
GSV 34 A2	20	2.572	6016642

Including FRS M6 x 20 bolt with flange nut.

Screwed version of joint connector for mesh cable trays.

Figure: Positioning and quantity of mesh cable tray connectors.

- 50–150 mm = 2 units
- 200–300 mm = 3 units
- 400–450 mm = 4 units
- 500–600 mm = 5 units

GRS quick connector

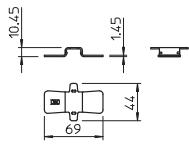

Type

Type	Pack Piece	Weight kg/100 pc.	Item no.
GRS 4.8 DD	50	2.500	6016561

When selecting the connector, please take the appropriate wire thickness of the mesh cable tray into account.

Quick connector for screwless straight connection of mesh cable trays without special tools, for mesh cable trays up to a width of 150 mm.

GRV 245 mesh cable tray connector, long

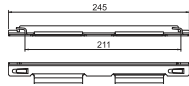

Type

Type	Width mm	Pack Piece	Weight kg/100 pc.	Item no.
GRV 245 FS	245	20	13.500	6016680
GRV 245 DD	245	20	13.500	6016684
GRV 245 A4	245	20	13.500	6016688

Two straight connectors, type GRV 245, are used for each connection point.

Can be used from a mesh cable tray width of 100 mm.

The FS variant is used to connect electrogalvanised mesh cable trays, the DD variant to connect hot/hot-dip galvanised mesh cable trays and the VA variant to connect stainless steel mesh cable trays.

Long mesh cable tray connectors for screwless straight connection of mesh cable trays.

GEV 36 corner connector

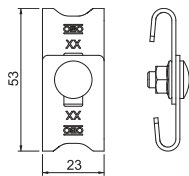

Type

Type	Pack Piece	Weight kg/100 pc.	Item no.
GEV 36 G	20	3.040	6016715
GEV 36 FT	20	3.160	6016723
GEV 36 A2	20	3.040	6016731

Including FRS M6 x 12 bolt with flange nut.

Corner connector for the creation of mesh cable tray bend elements.

GKS 34 hold-down clamp

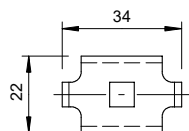

Type

Type	Pack Piece	Weight kg/100 pc.	Item no.
GKS 34 G	20	1.463	6016855
GKS 34 FT	20	2.021	6016820
GKS 34 A2	20	2.000	6016839

Including FRS M6 x 20 bolt with flange nut.

Clamp for fixing mesh cable trays to wall or support brackets.

GKT 38 clamping piece

Type	Pack Piece	Weight kg/100 pc.	Item no.
GKT 38 G	20	2.123	6017037
GKT 38 FT	20	2.123	6017061
GKT 38 A2	20	2.107	6017045

Including FRS M6 x 20 bolt with flange nut.
Clamp for fastening barrier strip in mesh cable trays.

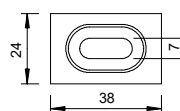

GKS 50 hold-down clamp

Type	Hole Ø mm	Pack Piece	Weight kg/100 pc.	Item no.
GKS 50 07 FS	7	50	3.522	6015263
GKS 50 11 FS	11	50	4.000	6015276
GKS 50 07 FT	7	50	4.100	6015271
GKS 50 11 FT	11	50	4.100	6015278
GKS 50 11 A4	11	20	4.000	6015280

Use on mesh cable trays with 50 x 100 mm grid only.
Hold-down clamp for fastening mesh cable trays on the ground or on stand-off brackets of type DBL.

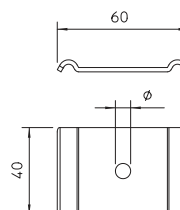

Earthing terminal for cables and flat conductors

Type	Shipping box Piece	Pack Piece	Weight kg/100 pc.	Item no.
939	150	25	5.932	5043107

- For cables to 16 mm² and flat conductors
- Fit: cable to 16 mm² x max. FL 30
- With riveted brass connection terminal and one cylinder bolt, M5 x 12, with two cylinder bolts, M6 x 16

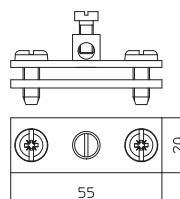

Earthing terminal with fastening thread

Type	Dim. L mm	Dim. I mm	Cross-section mm ²	Thread	Pack Piece	Weight kg/100 pc.	Item no.
EKL 25 M6	22	8	50	M6	50	3.100	6404006
EKL 35 M6	26	10	70	M6	50	4.800	6404014

Earthing terminal for fastening the equipotential bonding wire to the cable support system.
Suitable for conductor cross sections of 4–50 mm².

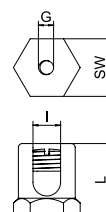

Exit plate

Type	Pack Piece	Weight kg/100 pc.	Item no.
KAB GR FS	10	14.100	6220139
KAB GR FT	10	14.100	6220142
KAB GR A2	10	14.100	6220145

The exit plate allows compliance with specific bend radii, thus preventing possible cable breaks.
Can be mounted in a lengthwise direction and at the side, can be arranged for greater widths.

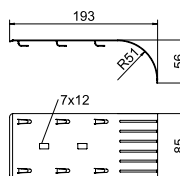

Mounting plate

Type	Height mm	Width mm	Pack Piece	Weight kg/100 pc.	Item no.
MP UNI FS	115	170	40	13.300	7084773
MP UNI A2	115	170	40	11.000	7085133

Please order the truss-head bolt, type FRSB 6 x 12, separately.
Mounting plate, for fastening on the side rail of cable support systems.

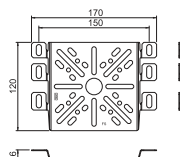

Identification clip

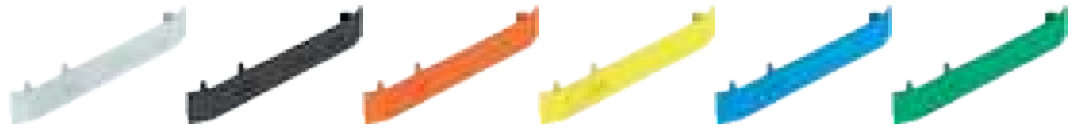
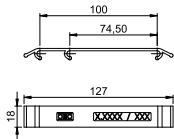

Type	KS GR LGR	KS GR VKG	KS GR OR	KS GR ZGB	KS GR LBL	KS GR SGN
Colour	Light grey	Traffic grey B	Pastel orange	Zinc yellow	Light blue	Signal green
Weight kg/100 pc.	0.769	0.920	0.763	0.742	0.763	0.763
Pack Piece	10	10	10	10	10	10
Item no.	6017710	6017711	6017712	6017713	6017714	6017715

The identification clip is fastened to the mesh cable tray without screws simply by attaching it.
Identification clip for screwless fastening on mesh cable trays.

End cap

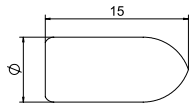

Type	Colour	Pack Piece	Weight kg/100 pc.	Item no.
GR KS 3.9 OR	Pure orange	500	0.045	6003750
GR KS 4.8 OR	Pure orange	500	0.030	6003754

End cap to cover cut wire ends of mesh cable trays.

Unperforated cover

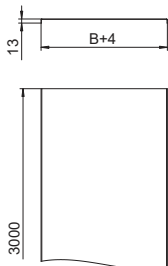

Type	Dim. B mm	Metal thickness mm	Length mm	Pack m	Weight kg/100 m	Item no.
DRLU 050 FS	50	1.00	3000	3	59.770	6052056
DRLU 100 FS	100	1.00	3000	3	99.000	6052103
DRLU 150 FS	150	1.00	3000	3	138.270	6052153
DRLU 200 FS	200	1.00	3000	3	177.500	6052210
DRLU 300 FS	300	1.00	3000	3	256.000	6052307
DRLU 400 FS	400	1.00	3000	3	334.670	6052405
DRLU 500 FS	500	1.50	3000	3	619.230	6052512
DRLU 600 FS	600	1.50	3000	3	737.000	6052609
DRLU 050 A2	50	1.00	3000	3	59.770	6052821
DRLU 100 A2	100	1.00	3000	3	99.000	6052824
DRLU 150 A2	150	1.00	3000	3	138.240	6052828
DRLU 200 A2	200	1.00	3000	3	177.500	6052831
DRLU 300 A2	300	1.00	3000	3	256.000	6052834
DRLU 400 A2	400	1.00	3000	3	334.500	6052837
DRLU 500 A2	500	1.50	3000	3	619.167	6052841
DRLU 600 A2	600	1.50	3000	3	736.900	6052844

Transverse bead from 500 mm width.

Cover for cable trays and mesh cable trays.

When using covers outdoors, additional measures against the influence of wind must be taken.

Cover clamp, universal

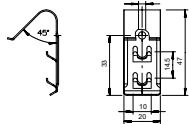

Type	Pack Piece	Weight kg/100 pc.	Item no.
DKU A2	20	0.794	6065600

Depending on the tray width, 4–6 cover clamps are required for secure fastening of a 3 m cover.
Cover clamp for universal fastening of covers on cable trays, mesh cable trays and AZ small ducts.

The cover clamp is not suitable for use with mesh cable trays with a side height of 35 mm.

Wall clamp and central hanger

Type	Version	Pack Piece	Weight kg/100 pc.	Item no.
WB GR FT	For wire thickness 6.0 mm	20	2.540	6017160
WB GR A4	For wire thickness 6.0 mm	20	2.423	6017164

Fastening component for direct mounting of mesh cable trays to the wall and floor. Can be screwed or riveted on.

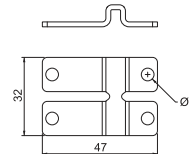

Heavy-duty cable tray SGR 55

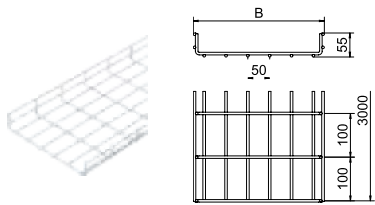

Type	Width mm	Wire Ø mm	Pack m	Weight kg/100 m	Item no.
SGR 55 150 FT	150	6	3	205.333	6000190
SGR 55 200 FT	200	6	3	238.667	6000209
SGR 55 300 FT	300	6	3	305.667	6000331
SGR 55 400 FT	400	6	3	372.667	6000451
SGR 55 500 FT	500	6	3	439.667	6000515
SGR 55 600 FT	600	6	3	507.000	6000775

The grid width is 50 x 100 mm.

Mesh cable tray made of spot-welded steel wire of side height 55 mm.

Magnetic shield insulation without cover 15 dB, with cover 25 dB.

Heavy-duty cable tray SGR 55

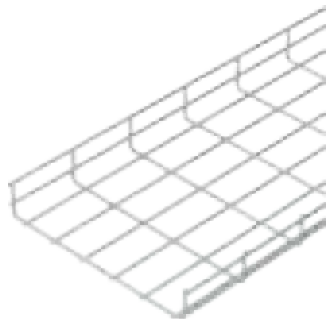

Type	Width mm	Wire Ø mm	Pack m	Weight kg/100 m	Item no.
SGR 55 150 G	150	6	3	199.000	6005472
SGR 55 200 G	200	6	3	230.067	6005474
SGR 55 300 G	300	6	3	293.233	6005476
SGR 55 400 G	400	6	3	357.033	6005478
SGR 55 500 G	500	6	3	426.333	6005480
SGR 55 600 G	600	6	3	491.667	6005482

Mesh cable tray made of spot-welded steel wire of side height 55 mm.

The grid dimension is 50 x 100 mm.

Stainless steel version on request.

Dimensions

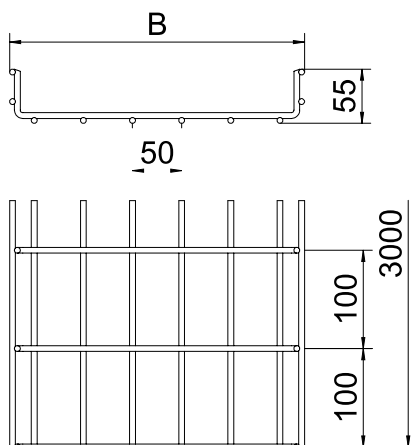

Type	Length mm	Usable Dim. B mm	Usable cross- section cm ²
SGR 55 150 G	3000	150	63
SGR 55 200 G	3000	200	87
SGR 55 300 G	3000	300	129
SGR 55 400 G	3000	400	175
SGR 55 500 G	3000	500	220
SGR 55 600 G	3000	600	265

Load

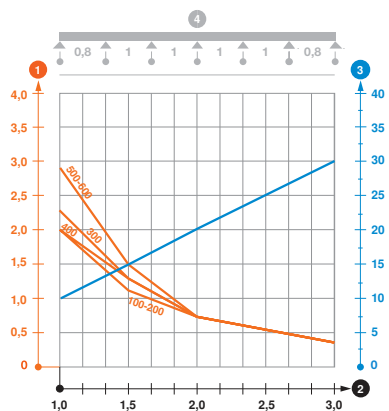

Type	Span			
	1.0 m kN/m	1.5 m kN/m	2.0 m kN/m	3.0 m kN/m
SGR 55 100 G	2	1.15	0.75	0.4
SGR 55 150 G	2	1.15	0.75	0.4
SGR 55 200 G	2	1.15	0.75	0.4
SGR 55 300 G	2	1.3	0.75	0.4
SGR 55 400 G	2.3	1.3	0.75	0.4
SGR 55 500 G	2.9	1.5	0.75	0.4
SGR 55 600 G	2.9	1.5	0.75	0.4

Load diagram, mesh cable tray, type SGR 55

- 1 Permitted cable tray/ladder load in kN/m without man load
- 2 Support width in m
- 3 Rail bend in mm at permitted kN/m
- 4 Load scheme during testing
- Load curve with cable tray/ladder width in mm
- Strut bend curve according to support width

Heavy-duty cable tray SGR 105

Type	Wire		Pack m	Weight kg/100 m	Item no.
	Width mm	Ø mm			
SGR 105 200 G	200	6	3	296.333	6002612
SGR 105 300 G	300	6	3	361.333	6002614
SGR 105 400 G	400	6	3	426.333	6002616
SGR 105 500 G	500	6	3	491.667	6002620
SGR 105 600 G	600	6	3	557.333	6002622

Mesh cable tray made of spot-welded steel wire of side height 105 mm.

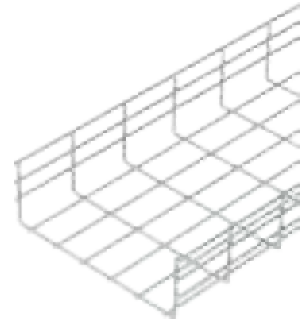

Type	Length mm	Dim. B mm	Usable Dim. cross-section	
			mm	cm ²
SGR 105 200 G	3000	200	175	
SGR 105 300 G	3000	300	268	
SGR 105 400 G	3000	400	363	
SGR 105 500 G	3000	500	459	
SGR 105 600 G	3000	600	554	

Dimensions

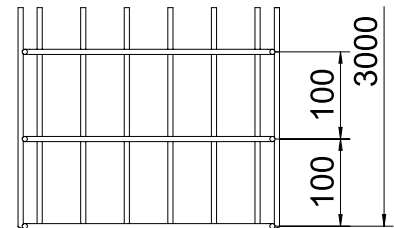
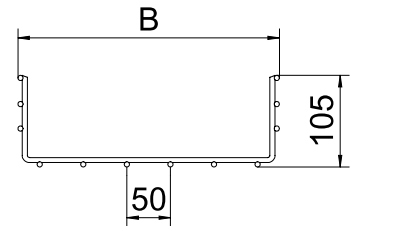

Load

Type	1.0 m	1.5 m	2.0 m	3.0 m	4.0 m
	kN/m	kN/m	kN/m	kN/m	kN/m
SGR 105 200 G	3.1	1.75	1.15	0.6	0.4
SGR 105 300 G	3.1	1.75	1.15	0.6	0.4
SGR 105 400 G	3.5	1.9	1.2	0.7	0.45
SGR 105 500 G	3.8	2	1.3	0.75	0.45
SGR 105 600 G	4.1	2.2	1.35	0.8	0.45

Load diagram, mesh cable tray, type SGR 105

- 1 Permitted cable tray/ladder load in kN/m without man load
- 2 Support width in m
- 3 Rail bend in mm at permitted kN/m
- 4 Load scheme during testing
- Load curve with cable tray/ladder width in mm
- Strut bend curve according to support width

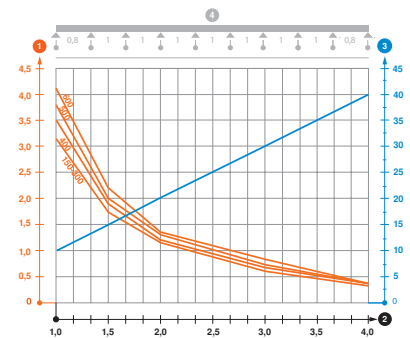

Heavy-duty cable tray SGR 105

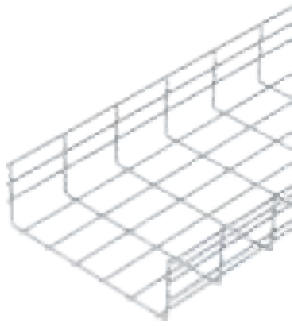

Type	Wire		Pack	Weight		Item no.
	Width	Ø		m	kg/100 m	
SGR 105 150 FT	150	6	3	272.333	6003175	
SGR 105 200 FT	200	6	3	305.667	6003214	
SGR 105 300 FT	300	6	3	372.667	6003309	
SGR 105 400 FT	400	6	3	439.667	6003402	
SGR 105 500 FT	500	6	3	507.000	6003515	
SGR 105 600 FT	600	6	3	574.667	6003616	

The grid width is 50 x 100 mm.

Mesh cable tray made of spot-welded steel wire of side height 105 mm.

Magnetic shield insulation without cover 15 dB, with cover 25 dB.

Dimensions

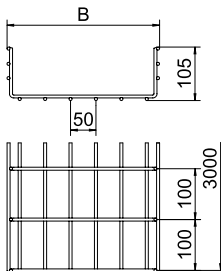

Type	Length	Dim. B	Usable cross-section
	mm	mm	cm ²
SGR 105 150 FT	3000	150	130
SGR 105 200 FT	3000	200	175
SGR 105 300 FT	3000	300	268
SGR 105 400 FT	3000	400	363
SGR 105 500 FT	3000	500	459
SGR 105 600 FT	3000	600	554

Load

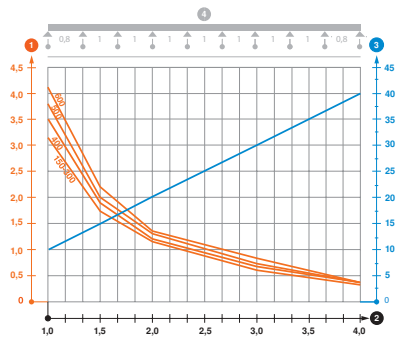

Type	1.0 m	1.5 m	2.0 m	3.0 m	4.0 m
	kN/m	kN/m	kN/m	kN/m	kN/m
SGR 105 150 FT	3.1	1.75	1.15	0.6	0.4
SGR 105 200 FT	3.1	1.75	1.15	0.6	0.4
SGR 105 300 FT	3.1	1.75	1.15	0.6	0.4
SGR 105 400 FT	3.5	1.9	1.2	0.7	0.45
SGR 105 500 FT	3.8	2	1.3	0.75	0.45
SGR 105 600 FT	4.1	2.2	1.35	0.8	0.45

Load diagram, mesh cable tray, type SGR 105

- 1 Permitted cable tray/ladder load in kN/m without man load
- 2 Support width in m
- 3 Rail bend in mm at permitted kN/m
- 4 Load scheme during testing
- Load curve with cable tray/ladder width in mm
- Strut bend curve according to support width

End cap

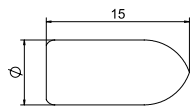

Type	Colour	Pack	Weight		Item no.
			Piece	kg/100 pc.	
SGR KS OR	Pure orange	500	0.036	6003758	

End cap to cover cut wire ends of mesh cable trays.

GUV 6 joint connector

Type	Pack Piece	Weight kg/100 pc.	Item no.
GUV 6 FT	20	4.226	6016573

Including FRS M8 x 25 bolt with flange nut.

Joint connector for mesh cable tray, type SGR.

Figure: Positioning and quantity of mesh cable tray connectors.

- 50–150 mm = 2 units
- 200–300 mm = 3 units
- 400–450 mm = 4 units
- 500–600 mm = 5 units

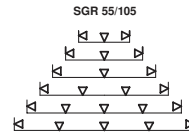
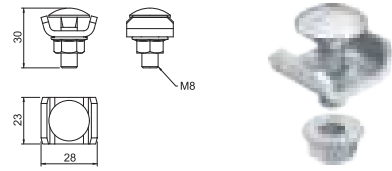

GUV 6 joint connector

Type	Pack Piece	Weight kg/100 pc.	Item no.

Including FRS M8 x 20 bolt with flange nut.

Joint connector for mesh cable tray, type SGR.

Figure: Positioning and quantity of mesh cable tray connectors.

- 50–150 mm = 2 units
- 200–300 mm = 3 units
- 400–450 mm = 4 units
- 500–600 mm = 5 units

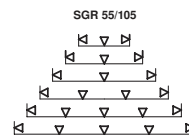
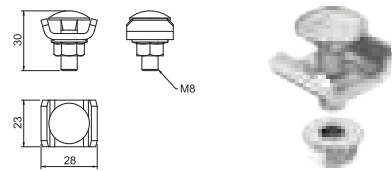

Wall clamp / central hanger

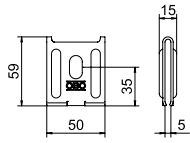

Type

Type	Pack Piece	Weight kg/100 pc.	Item no.
K 12 1818 FS	25	8.772	6437109
K12 1818 A2	25	8.772	6016421

As wall fastening up to max. mesh cable tray width 200 mm.
 As centre suspension up to max. mesh cable tray width 200 mm.
 As a pendulum suspension from a width of 300 mm.
 Wall clamp and central hanger for mesh cable trays.

Mounting plate for mesh cable tray

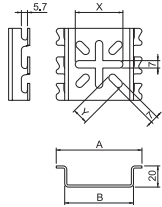

Type

Type	Pack Piece	Weight kg/100 pc.	Item no.
MPG 65 FT	30	9.100	6006486
MPG 90 FT	30	16.800	6006487

Mounting plate for screwless wall fastening of mesh cable trays.

Threaded rod



Type	Thread	Dim.	Dim.	Pack Piece	Weight kg/100 pc.	Item no.
		d mm	L mm			
TR M8 1M G	M8	8	1000	10	30.000	3141128
TR M10 1M G	M10	10	1000	10	49.000	3141209
TR M12 1M G	M12	12	1000	10	62.000	3141306

Threaded rod to DIN 976.

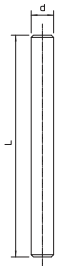

Side holder

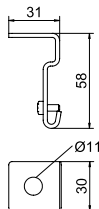

Type

Type	Pack Piece	Weight kg/100 pc.	Item no.
SH M10 FS	50	5.800	6015336
SH M10 FT	50	6.000	6015338
SH M10 A4	20	5.500	6015340

Side holder for suspension of mesh cable trays.

TP profile

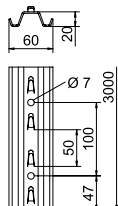

Type

Type	Length mm	Pack Piece	Weight kg/100 pc.	Item no.
TPSG 3000 FS	3000	1	401.700	6366090

TP profile with clamping lugs.

Stand-off bracket

Type	Height mm	Dim. A mm	Dim. B mm	Dim. L mm	Pack Piece	Weight kg/100 pc.	Item no.
DBLG 20 050 FS	20	30	56	120	20	10.300	6015646
DBLG 20 100 FS	20	30	106	170	20	12.076	6015654
DBLG 20 150 FS	20	30	156	220	20	17.400	6015658
DBLG 20 200 FS	20	30	206	270	20	20.900	6015662
DBLG 20 300 FS	20	40	306	370	20	37.300	6015670
DBLG 20 400 FS	20	40	406	470	20	46.700	6015689
DBLG 20 500 FS	20	40	506	570	25	56.900	6015693
DBLG 20 600 FS	20	40	606	670	25	66.400	6015697
DBLG 20 050 FT	20	30	56	120	20	10.700	6015648
DBLG 20 100 FT	20	30	106	170	20	14.300	6015656
DBLG 20 150 FT	20	30	156	220	20	18.100	6015660
DBLG 20 200 FT	20	30	206	270	20	21.700	6015664
DBLG 20 300 FT	20	40	306	370	20	38.800	6015672
DBLG 20 400 FT	20	40	406	470	20	48.600	6015691
DBLG 20 500 FT	20	40	506	570	25	54.702	6015695
DBLG 20 600 FT	20	40	606	670	25	69.100	6015699

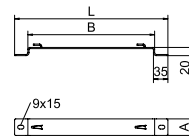

Screwless fastening of the mesh cable tray on the stand-off bracket.

Stand-off bracket for stand-off of mesh cable trays on the floor or on the wall.

GRM mesh cable tray types with side heights of 35, 55 and 105 mm can be mounted onto the spacer clamp.

Ceiling bracket K6

Type	Pack Piece	Weight kg/100 pc.	Item no.
K 6 101 FS	40	7.000	6343090
K 6 101 FT	40	7.000	6343104

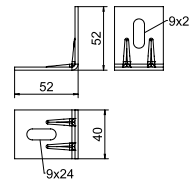

Ceiling bracket for universal fixing to ceiling and wall, or on suspension profile, type AP 45.





Cable ladder systems

	Side rail height 50 mm	136
	Side rail height 75 mm	139
	Side rail height 100 mm	142
	Accessories for side rail height 50, 75, 100 mm	145



Side height 50 mm

Cable ladder LG 50, 3 m

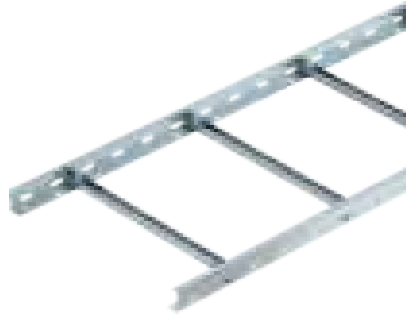

Type	Width mm	Pack m	Weight kg/100 m	Item no.
LG 520 VS FS	200	3	241.933	6487012
LG 530 VS FS	300	3	263.667	6487014
LG 545 VS FS	450	3	297.800	6487017
LG 560 VS FS	600	3	328.900	6487019
LG 520 VS FT	200	3	257.967	6487002
LG 530 VS FT	300	3	281.167	6487004
LG 545 VS FT	450	3	317.567	6487007
LG 560 VS FT	600	3	350.700	6487009

Cable ladder with perforated side rail of side height 50 mm with riveted C profile rungs, open in an upwards direction. Assignment of the rungs on both sides possible using U clamps.

Magnetic shield insulation without cover 10 dB, with cover 15 dB.

Dimensions

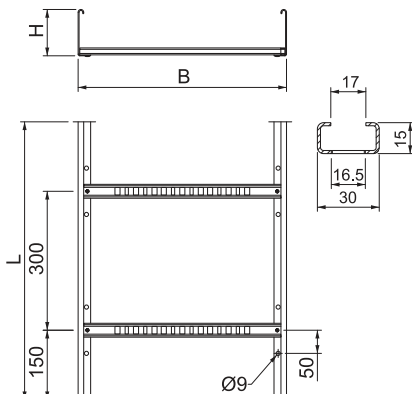

Type	Length mm	Rail thick- ness mm	Usable cross- section cm ²	Rung spacing mm
LG 520 VS FS	3000	1.5	60	300
LG 530 VS FS	3000	1.5	90	300
LG 545 VS FS	3000	1.5	134	300
LG 560 VS FS	3000	1.5	179	300

90° bend 50

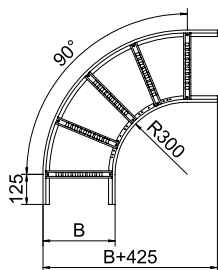

Type	Width mm	Pack Piece	Weight kg/100 pc.	Item no.
LB 90 520 VS FS	200	1	232.900	6487212
LB 90 530 VS FS	300	1	294.900	6487214
LB 90 545 VS FS	450	1	370.500	6487216
LB 90 560 VS FS	600	1	480.700	6487218
LB 90 520 VS FT	200	1	248.300	6487202
LB 90 530 VS FT	300	1	314.500	6487204
LB 90 545 VS FT	450	1	395.100	6487206
LB 90 560 VS FT	600	1	512.600	6487208

Connectors should be ordered separately and in the appropriate quantity.

90° horizontal bend, with intelligent VS rung, for all cable ladder types of 50 mm side height.

Adjustable connector 50

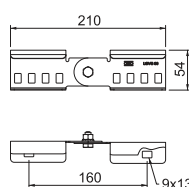

Type	Side height mm	Pack Piece	Weight kg/100 pc.	Item no.
LGVG 50 FS	50	10	26.400	6487315
LGVG 50 FT	50	10	27.700	6487305

Adjustable connector as external connector to join cable ladders and fittings with a side height of 50 mm and continuous rail perforation. Angle can be adjusted vertically.

Straight connector 50

Type	Side height mm	Pack Piece	Weight kg/100 pc.	Item no.
LVG 50 FS	50	10	21.900	6487335
LVG 50 FT	50	10	23.500	6487325

Straight connector as external connector to connect cable ladders and fittings with a side height of 50 mm and continuous side perforation.

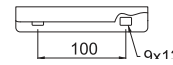
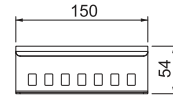

Angle connector 50

Type	Side height mm	Pack Piece	Weight kg/100 pc.	Item no.
LWVG 50 FS	50	10	25.400	6487362
LWVG 50 FT	50	10	27.600	6487352

Angle connector as external connector to join cable ladders and fittings with a side height of 50 mm and continuous rail perforation.

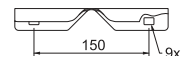
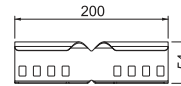

Multifunctional connector 50

Type	Side height mm	Dim. B mm	Metal thickness mm	Pack Piece	Weight kg/100 pc.	Item no.
LMFV 520 FS	50	200	1.50	1	109.800	6487412
LMFV 530 FS	50	300	1.50	1	116.200	6487414
LMFV 545 FS	50	450	1.50	1	126.500	6487416
LMFV 560 FS	50	600	1.50	1	135.800	6487418
LMFV 520 FT	50	200	1.50	1	117.100	6487402
LMFV 530 FT	50	300	1.50	1	123.900	6487404
LMFV 545 FT	50	450	1.50	1	134.900	6487406
LMFV 560 FT	50	600	1.50	1	144.800	6487408

Multifunctional connector for joining cable ladders with a side height of 50 mm. Symmetrical and asymmetrical reductions, infinitely-adjustable bends between 0–60° and add-on tees can be created.

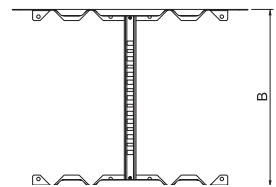
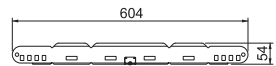

T piece VS 50

Type	Width mm	Pack Piece	Weight kg/100 pc.	Item no.
LT 520 VS FS	200	1	451.000	6487672
LT 530 VS FS	300	1	519.200	6487674
LT 545 VS FS	450	1	624.700	6487676
LT 560 VS FS	600	1	723.600	6487678
LT 520 VS FT	200	1	480.900	6487662
LT 530 VS FT	300	1	553.600	6487664
LT 545 VS FT	450	1	666.100	6487666
LT 560 VS FT	600	1	771.600	6487668

Connectors should be ordered separately and in the appropriate quantity.

T piece, horizontal, with intelligent VS rung, for all cable ladder types of 50 mm side height.

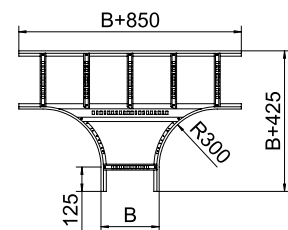

Side height 50 mm

VS 50 cross-over

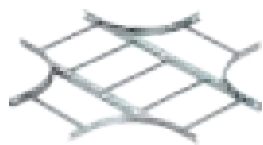

Type	Width mm	Pack Piece	Weight kg/100 pc.	Item no.
LK 520 VS FS	200	1	620.100	6487512
LK 530 VS FS	300	1	703.000	6487514
LK 545 VS FS	450	1	831.700	6487516
LK 560 VS FS	600	1	951.700	6487518
LK 520 VS FT	200	1	661.200	6487502
LK 530 VS FT	300	1	749.600	6487504
LK 545 VS FT	450	1	886.900	6487506
LK 560 VS FT	600	1	1,014.800	6487508

Connectors should be ordered separately and in the appropriate quantity.

Horizontal cross-over, with intelligent VS rung, for all cable ladder types of 50 mm side height.

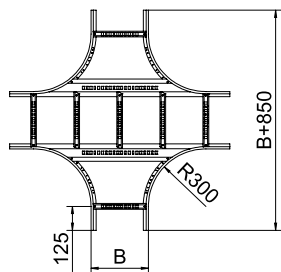

Cable ladder LG 75, 3 m VS

Type	Width mm	Pack m	Weight kg/100 m	Item no.
LG 720 VS FS	200	3	292.900	6487052
LG 730 VS FS	300	3	314.667	6487054
LG 745 VS FS	450	3	348.767	6487057
LG 760 VS FS	600	3	379.867	6487059
LG 775 VS FS	750	3	562.300	6487062
LG 7100 VS FS	1000	3	641.733	6487065
LG 720 VS FT	200	3	312.333	6487032
LG 730 VS FT	300	3	335.533	6487034
LG 745 VS FT	450	3	371.900	6487037
LG 760 VS FT	600	3	405.067	6487039
LG 775 VS FT	750	3	590.267	6487042
LG 7100 VS FT	1000	3	684.300	6487045

Cable ladder with perforated side rail of side height 75 mm with riveted C profile rungs, open in an upwards direction. Assignment of the rungs on both sides possible using U clamps.

Type	Length mm	Rail thick- ness mm	Usable cross- section cm ²	Rung spacing mm
LG 720 VS FS	3000	1.5	108	300
LG 730 VS FS	3000	1.5	163	300
LG 745 VS FS	3000	1.5	246	300
LG 760 VS FS	3000	1.5	328	300
LG 775 VS FS	3000	2	410	300
LG 7100 VS FS	3000	2	548	300

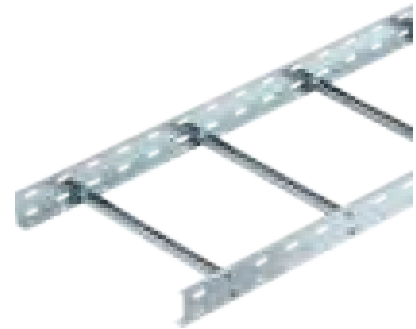

Dimensions

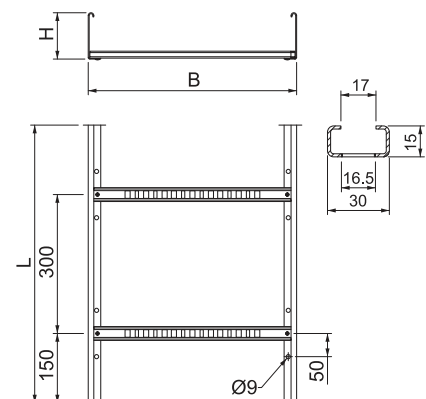

Adjustable connector 75

Type	Side height mm	Pack Piece	Weight kg/100 pc.	Item no.
LGVG 75 FS	75	10	36.700	6487317
LGVG 75 FT	75	10	38.300	6487307

Adjustable connector as external connector to join cable ladders and fittings with a side height of 75 mm and continuous rail perforation. Angle can be adjusted vertically.

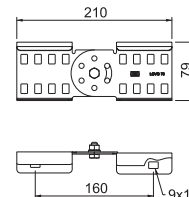

Straight connector 75

Type	Side height mm	Pack Piece	Weight kg/100 pc.	Item no.
LVG 75 FS	75	10	31.100	6487337
LVG 75 FT	75	10	33.400	6487327

Straight connector as external connector to connect cable ladders and fittings with a side height of 75 mm and continuous side perforation.

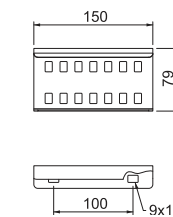

Angle connector 75

Type	Side height mm	Pack Piece	Weight kg/100 pc.	Item no.
LWVG 75 FS	75	10	36.000	6487364
LWVG 75 FT	75	10	39.600	6487354

Angle connector as external connector to join cable ladders and fittings with a side height of 75 mm and continuous rail perforation.

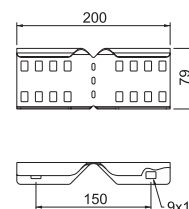

Side height 75 mm

Multifunctional connector 75

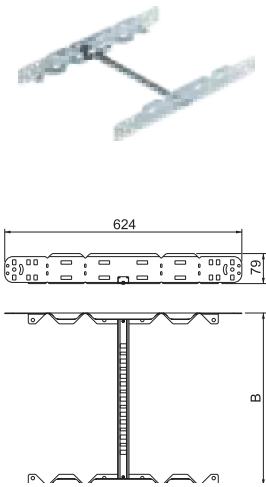

Type	Side height mm	Dim. B mm	Metal thickness mm	Pack Piece	Weight kg/100 pc.	Item no.
LMFV 720 FS	75	200	1.50	1	143.100	6487432
LMFV 730 FS	75	300	1.50	1	149.800	6487434
LMFV 745 FS	75	450	1.50	1	159.800	6487436
LMFV 760 FS	75	600	1.50	1	169.200	6487438
LMFV 720 FT	75	200	1.50	1	152.800	6487422
LMFV 730 FT	75	300	1.50	1	159.800	6487424
LMFV 745 FT	75	450	1.50	1	170.700	6487426
LMFV 760 FT	75	600	1.50	1	180.700	6487428

Multifunctional connector for joining cable ladders with a side height of 75 mm. Symmetrical and asymmetrical reductions, infinitely-adjustable bends between 0–60° and add-on tees can be created.

90° bend VS 75

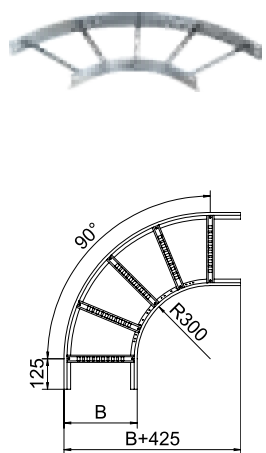

Type	Width mm	Pack Piece	Weight kg/100 pc.	Item no.
LB 90 720 VS FS	200	1	283.400	6487242
LB 90 730 VS FS	300	1	350.000	6487244
LB 90 745 VS FS	450	1	436.200	6487246
LB 90 760 VS FS	600	1	549.800	6487248
LB 90 775 VS FS	750	1	768.080	6487250
LB 90 7100 VS FS	1000	1	962.860	6487252
LB 90 720 VS FT	200	1	302.200	6487222
LB 90 730 VS FT	300	1	373.200	6487224
LB 90 745 VS FT	450	1	461.300	6487226
LB 90 760 VS FT	600	1	586.300	6487228
LB 90 775 VS FT	750	1	812.060	6487230
LB 90 7100 VS FT	1000	1	1,016.810	6487232

Connectors should be ordered separately and in the appropriate quantity.

90° horizontal bend, with intelligent VS rung, for all cable ladder types of 75 mm side height.

T piece VS 75

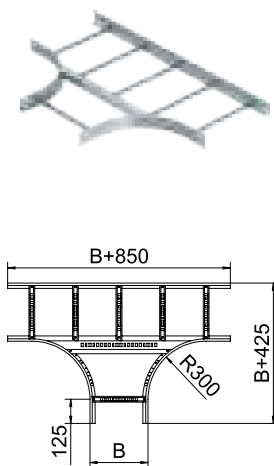

Type	Width mm	Pack Piece	Weight kg/100 pc.	Item no.
LT 720 VS FS	200	1	522.700	6487702
LT 730 VS FS	300	1	594.400	6487704
LT 745 VS FS	450	1	704.400	6487706
LT 760 VS FS	600	1	807.600	6487708
LT 775 VS FS	750	1	1,112.700	6487710
LT 7100 VS FS	1000	1	1,358.700	6487712
LT 720 VS FT	200	1	557.400	6487682
LT 730 VS FT	300	1	633.800	6487684
LT 745 VS FT	450	1	751.100	6487686
LT 760 VS FT	600	1	861.200	6487688
LT 775 VS FT	750	1	1,186.500	6487690
LT 7100 VS FT	1000	1	1,448.800	6487692

Connectors should be ordered separately and in the appropriate quantity.

T piece, horizontal, with intelligent VS rung, for all cable ladder types of 75 mm side height.

VS 75 cross-over

Type	Width mm	Pack Piece	Weight kg/100 pc.	Item no.
LK 720 VS FS	200	1	702.800	6487552
LK 730 VS FS	300	1	785.700	6487554
LK 745 VS FS	450	1	914.400	6487557
LK 760 VS FS	600	1	1,034.400	6487558
LK 775 VS FS	750	1	1,379.800	6487560
LK 7100 VS FS	1000	1	1,662.300	6487565
LK 720 VS FT	200	1	749.400	6487532
LK 730 VS FT	300	1	837.800	6487534
LK 745 VS FT	450	1	975.000	6487536
LK 760 VS FT	600	1	1,103.000	6487538
LK 775 VS FT	750	1	1,471.300	6487540
LK 7100 VS FT	1000	1	1,772.600	6487544

Connectors should be ordered separately and in the appropriate quantity.

Horizontal cross-over, with intelligent VS rung, for all cable ladder types of 75 mm side height.

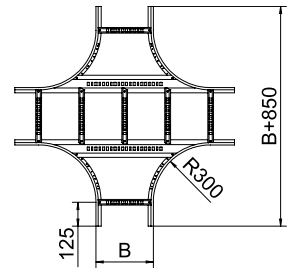

Side height 100 mm

Cable ladder LG 100, 3 m VS



Type	Width mm	Pack m	Weight kg/100 m	Item no.
LG 1020 VS FS	200	3	450.067	6487122
LG 1030 VS FS	300	3	471.833	6487124
LG 1045 VS FS	450	3	505.967	6487127
LG 1060 VS FS	600	3	537.033	6487129
LG 1075 VS FS	750	3	640.800	6487132
LG 1090 VS FS	900	3	688.433	6487134
LG 10100 VS FS	1000	3	720.233	6487136
LG 1020 VS FT	200	3	479.933	6487102
LG 1030 VS FT	300	3	503.133	6487104
LG 1045 VS FT	450	3	539.533	6487107
LG 1060 VS FT	600	3	572.667	6487109
LG 1075 VS FT	750	3	672.667	6487112
LG 1090 VS FT	900	3	722.667	6487114
LG 10100 VS FT	1000	3	756.067	6487116

Cable ladder with perforated side rail of side height 100 mm with riveted C profile rungs, open in an upwards direction. Assignment of the rungs on both sides possible using U clamps.

Dimensions

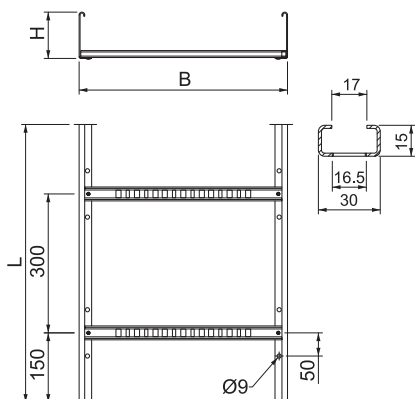

Type	Length mm	Rail thickness mm	Usable cross-section cm ²	Rung spacing mm
LG 1020 VS FS	3000	2	158	300
LG 1030 VS FS	3000	2	238	300
LG 1045 VS FS	3000	2	358	300
LG 1060 VS FS	3000	2	478	300
LG 1075 VS FS	3000	2	598	300
LG 1090 VS FS	3000	2	718	300
LG 10100 VS FS	3000	2	798	300

Adjustable connector 100

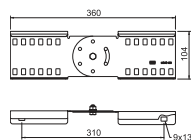

Type	Side height mm	Pack Piece	Weight kg/100 pc.	Item no.
LGVG 100 FS	100	10	70.200	6487319
LGVG 100 FT	100	10	74.000	6487309

Adjustable connector as external connector to join cable ladders and fittings with a side height of 100 mm and continuous rail perforation. Angle can be adjusted vertically.

Straight connector 100

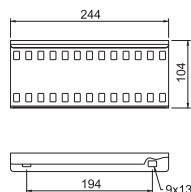

Type	Side height mm	Pack Piece	Weight kg/100 pc.	Item no.
LVG 100 FS	100	10	50.500	6487339
LVG 100 FT	100	10	54.100	6487329

Straight connector as external connector to join cable ladders and fittings with a side height of 100 mm and continuous side perforation.

Angle connector 100

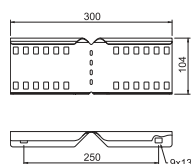

Type	Side height mm	Pack Piece	Weight kg/100 pc.	Item no.
LWVG 100 FS	100	10	58.200	6487366
LWVG 100 FT	100	10	63.200	6487356

Angle connector as external connector to join cable ladders and fittings with a side height of 100 mm and continuous rail perforation.

Multifunctional connector 100

Type	Side height mm	Dim. B mm	Metal thickness mm	Pack Piece	Weight kg/100 pc.	Item no.
LMFV 120 FS	100	200	1.50	1	191.800	6487462
LMFV 130 FS	100	300	1.50	1	198.200	6487464
LMFV 145 FS	100	450	1.50	1	208.500	6487466
LMFV 160 FS	100	600	1.50	1	217.900	6487468
LMFV 120 FT	100	200	1.50	1	204.500	6487452
LMFV 130 FT	100	300	1.50	1	211.300	6487454
LMFV 145 FT	100	450	1.50	1	222.300	6487456
LMFV 160 FT	100	600	1.50	1	232.400	6487458

Multifunctional connector for joining cable ladders with a side height of 100 mm. Symmetrical and asymmetrical reductions, infinitely-adjustable bends between 0–60° and add-on tees can be created.

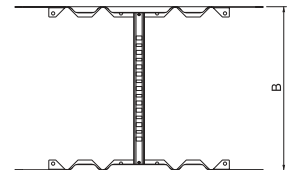
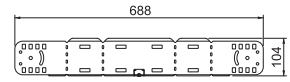

90° bend VS 100

Type	Width mm	Pack Piece	Weight kg/100 pc.	Item no.
LB 90 120 VS FS	200	1	501.300	6487282
LB 90 130 VS FS	300	1	579.000	6487284
LB 90 145 VS FS	450	1	708.700	6487286
LB 90 160 VS FS	600	1	812.200	6487288
LB 90 175 VS FS	750	1	1,080.400	6487290
LB 90 190 VS FS	900	1	1,288.500	6487291
LB 90 10100VS FS	1000	1	1,388.900	6487292
LB 90 120 VS FT	200	1	534.500	6487262
LB 90 130 VS FT	300	1	617.400	6487264
LB 90 145 VS FT	450	1	757.700	6487266
LB 90 160 VS FT	600	1	866.100	6487268
LB 90 175 VS FT	750	1	1,152.100	6487270
LB 90 190 VS FT	900	1	1,374.000	6487271
LB 90 10100VS FT	1000	1	1,481.000	6487272

Connectors should be ordered separately and in the appropriate quantity.

90° horizontal bend, with intelligent VS rung, for all cable ladder types of 100 mm side height.

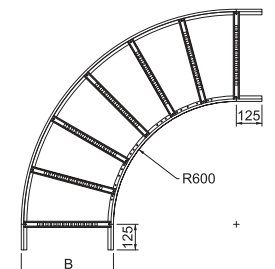

T piece VS 100

Type	Width mm	Pack Piece	Weight kg/100 pc.	Item no.
LT 1020 VS FS	200	1	979.500	6487743
LT 1030 VS FS	300	1	1,066.600	6487744
LT 1045 VS FS	450	1	1,231.300	6487746
LT 1060 VS FS	600	1	1,366.900	6487748
LT 1075 VS FS	750	1	1,774.300	6487751
LT 1090 VS FS	900	1	1,970.400	6487752
LT 10100 VS FS	1000	1	2,100.700	6487754
LT 1020 VS FT	200	1	1,044.500	6487722
LT 1030 VS FT	300	1	1,137.300	6487724
LT 1045 VS FT	450	1	1,313.000	6487727
LT 1060 VS FT	600	1	1,457.600	6487728
LT 1075 VS FT	750	1	1,892.000	6487730
LT 1090 VS FT	900	1	2,101.100	6487732
LT 10100 VS FT	1000	1	2,240.000	6487735

Connectors should be ordered separately and in the appropriate quantity.

T piece, horizontal, with intelligent VS rung, for all cable ladder types of 100 mm side height.

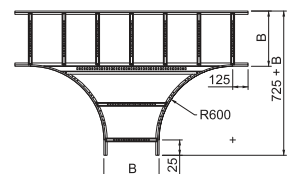

Side height 100 mm

VS 100 cross-over

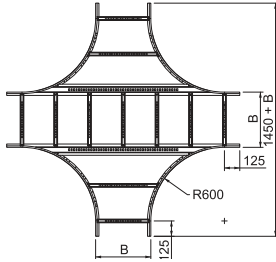

Type	Width mm	Pack Piece	Weight kg/100 pc.	Item no.
LK 1020 VS FS	200	1	1,346.400	6487602
LK 1030 VS FS	300	1	1,448.900	6487604
LK 1045 VS FS	450	1	1,638.000	6487606
LK 1060 VS FS	600	1	1,795.200	6487608
LK 1075 VS FS	750	1	2,273.400	6487610
LK 1090 VS FS	900	1	2,502.400	6487612
LK 10100 VS FS	1000	1	2,654.300	6487614
LK 1020 VS FT	200	1	1,435.700	6487582
LK 1030 VS FT	300	1	1,545.000	6487584
LK 1045 VS FT	450	1	1,746.600	6487586
LK 1060 VS FT	600	1	1,914.300	6487588
LK 1075 VS FT	750	1	2,424.200	6487590
LK 1090 VS FT	900	1	2,668.400	6487592
LK 10100 VS FT	1000	1	2,830.400	6487594

Connectors should be ordered separately and in the appropriate quantity.

Horizontal cross-over, with intelligent VS rung, for all cable ladder types of 100 mm side height.

LKS 40 hold-down clamp

Type	Pack Piece	Weight kg/100 pc.	Item no.	
LKS 40 FT	10	2.400	6221084	

Fastening on brackets, type MWA 12, AW 15, AW 30 and AW 55, using the supplied FRS M6 x 20 fastening bolt.
Hold-down clamp for fastening cable ladders.

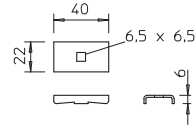

LKS 60/4 hold-down clamp

Type	Pack Piece	Weight kg/100 pc.	Item no.	
LKS 60 4 FT	10	6.500	6221122	

Fastening on brackets, type MWA 12, AW 15, AW 30 and AW 55, using the enclosed truss-head bolt FRS M6x20.
Hold-down clamp for fastening cable ladders.

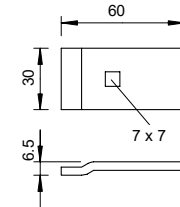

Truss-head bolt with flange nut

Type	Dimension mm	Dim. L mm	Dim. d mm	Dim. D mm	Resistance grade	Pack Piece	Weight kg/100 pc.	Item no.	
FRSB 6x30 F	M 6 x 30	30	6	13.5	5.6	100	1.232	6406907	

Truss-head bolt with square neck including flange nut.

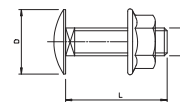

Cover with turn buckle

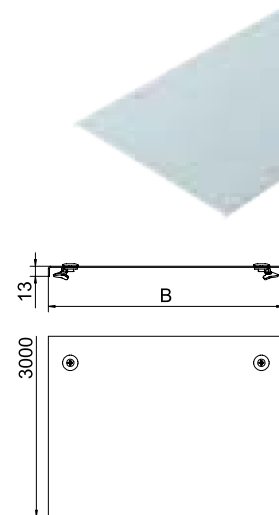

Type	Dim. B mm	Metal thickness mm	Length mm	Pack m	Weight kg/100 m	Item no.	
DRL 200 FS	200	1.00	3000	3	181.340	6052207	
DRL 300 FS	300	1.00	3000	3	259.334	6052304	
DRL 400 FS	400	1.00	3000	3	338.670	6052401	
DRL 500 FS	500	1.25	3000	3	623.000	6052509	
DRL 600 FS	600	1.25	3000	3	741.000	6052606	
DRL 200 A2	200	1.00	3000	3	183.500	6052894	
DRL 300 A2	300	1.00	3000	3	262.240	6052908	
DRL 400 A2	400	1.00	3000	3	340.400	6052932	
DRL 500 A2	500	1.25	3000	3	625.340	6052959	
DRL 600 A2	600	1.25	3000	3	743.240	6052975	

Transverse bead from 500 mm width.
Cover for cable trays and cable ladders with turn buckles.
When using covers outdoors, additional measures against the influence of wind must be taken.

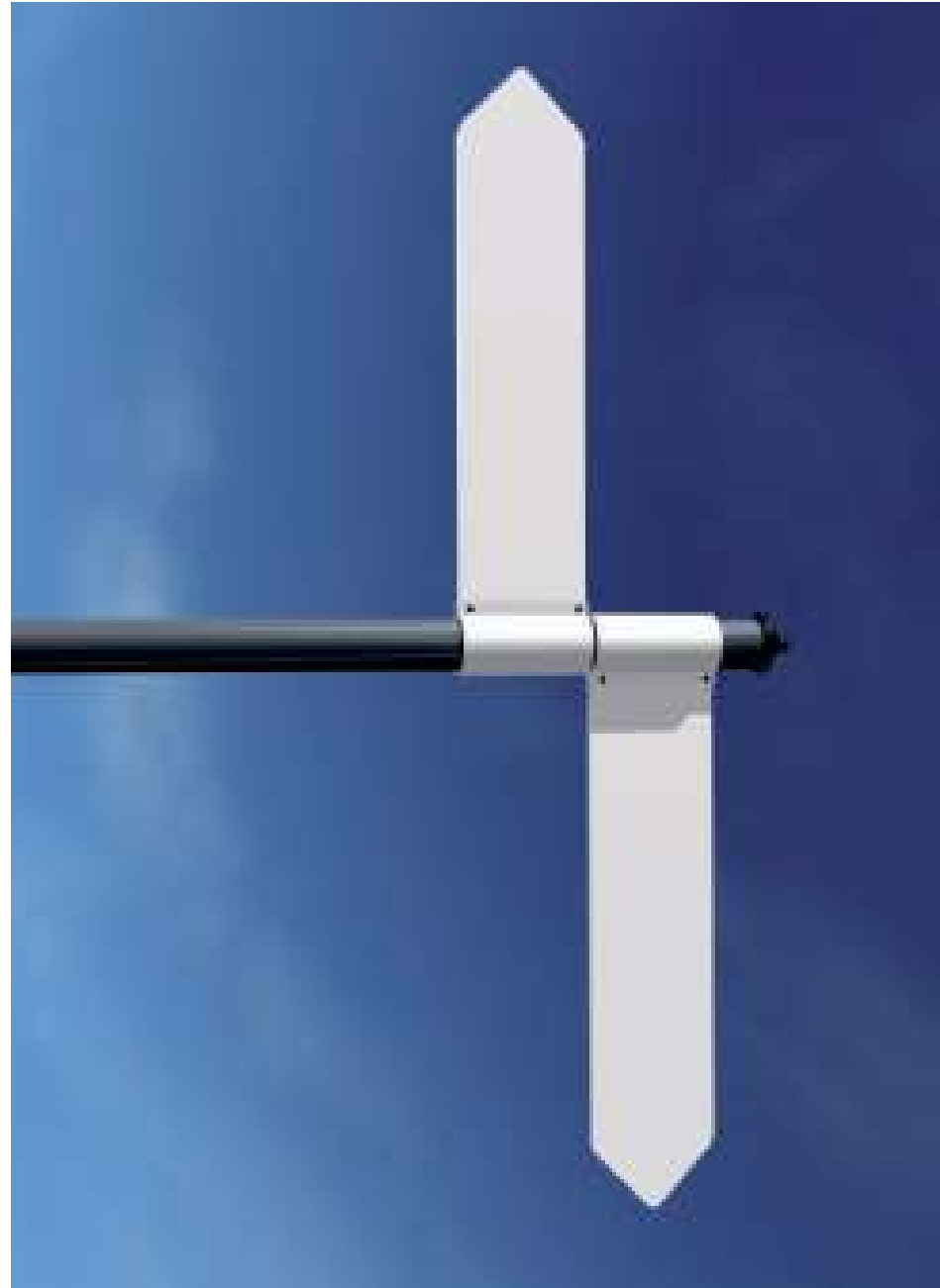



Directories

	Numeric directory	148
	Type listing	152



GTIN	Item no.	Page	GTIN	Item no.	Page	GTIN	Item no.	Page	GTIN	Item no.	Page	GTIN	Item no.	Page
5041771	price/100 1109871	62	6000432	price/m 6000916	122	6785414	price/ 6015565	44	6611898	price/m 6051367	98	6979028	6058206	84
5632535	1112759	62	6000494	6000924	122	6785476	6015573	44	6611775	6051383	98	6979097	6058303	84
5047056	1118129	62	6000555	6000932	122	6785537	6015581	44	6611713	6051413	98	6979196	6058397	84
5047599	1119656	62	6000616	6000940	122	6785599	6015603	44	6087792	6051448	98	6979264	6058508	84
5049210	1121464	62	6000678	6000959	122	6785650	6015611	44	6595631	6051472	98	6979332	6058605	84
5686262	1122918	62	6397914	6002612	129	5239208	6015614	44	6029655	6052056	97	6061457	price/m 6058620	84
5686279	1122920	62	6397921	6002614	129	5239215	6015617	44	6057979	6052096	98	6061518	6058647	84
5697541	1122923	63	6397938	6002616	129	6961528	6015646	133	6029716	6052103	97	6061570	6058663	84
5686293	1122924	63	6397945	6002620	129	6042845	6015648	133	6058099	6052150	98	6061631	6058698	84
5486022	/100 pc. 1124645	63	6397952	6002622	129	6961580	6015654	133	6030019	6052153	97	6061693	6058728	84
5486039	1124647	63	6344611	6002749	123	6042968	6015656	133	6058150	6052207	98	6061754	6058744	84
5486046	1124649	63	6624553	6002803	123	6279371	6015658	133	6030071	6052210	97	6979431	6061110	89
5486091	1124659	63	6344628	6002811	123	6043088	6015660	133	6058273	6052304	98	6979509	6061207	89
5486107	1124661	63	6515448	6002815	123	6961641	6015662	133	6031399	6052307	97	6979578	6061304	89
5486114	1124663	64	6353958	6002838	123	6043200	6015664	133	6058396	6052401	98	6979615	6061401	89
6559824	1124792	64	6354016	6002846	123	6961702	6015670	133	6031511	6052405	97	6979660	6061509	89
6559831	1124796	64	6354078	6002854	123	6043323	6015672	133	5460145	6052450	98	6062539	price/m 6061605	89
6559848	1124798	64	6354139	6002862	123	6961764	6015689	133	6058518	6052509	98	6062591	6061621	89
5253334	3141128	44	6354191	6002870	123	6043446	6015691	133	6031634	6052512	97	6062652	6061656	89
5253396	3141209	44	6515455	6002874	123	5239222	6015693	133	6058754	6052606	98	6062713	6061672	89
5253457	3141306	44	6397716	6003175	130	5239260	6015695	133	6031757	6052609	97	6062775	6061702	89
5255970	3156516	68	6002474	6003206	123	5239277	6015697	133	6031818	6052821	97	5694441	6062025	77
5256632	3158632	68	5670742	6003214	130	5239284	6015699	133	6031931	6052824	97	5694489	6062033	77
5256694	3158640	68	6002535	6003303	123	6013036	6016421	132	6031993	6052828	97	5694540	6062068	78
5257295	3160742	68	6397723	6003309	130	6517992	6016561	124	6032051	6052831	97	5694557	6062084	78
5505631	3160793	52	6002597	6003400	123	6593866	6016572	131	6032174	6052834	97	5694571	6062114	84
5298151	3400085	69	5651765	6003402	130	6593873	6016573	131	6032235	6052837	97	5694588	6062122	90
5298212	3400107	69	6002658	6003508	123	6593880	6016574	131	6032297	6052841	97	5060369	6063234	77
5298274	3400123	69	6397730	6003515	130	6520510	6016596	124	6032358	6052844	97	5060390	6063236	77
5298458	3400352	69	6002719	6003605	123	6013159	6016634	124	6058877	6052878	98	5060406	6063238	77
5300076	3402088	69	6397747	6003616	130	6013210	6016642	124	5995838	6052886	98	6063857	6063241	77
5300137	3402096	69	5872887	6003750	126	6054251	6016644	124	6058938	6052894	98	6063918	6063276	77
5300199	3402126	69	5872894	6003754	126	6054312	6016688	124	6059058	6052932	98	6395231	6063403	90
5300793	3402452	69	5872900	6003758	130	6054322	6016688	124	6059119	6052959	98	6395293	6063438	90
5301691	3404080	69	6307937	6017037	125	6013579	6017045	125	6059171	6052975	98	6395354	6063454	90
5301752	3404102	69	6013579	6017045	125	6013630	6017061	125	6978618	6056106	74	6395415	6063470	90
5301813	3404129	69	6013630	6017061	125	6561254	6017160	127	6542659	6056148	76	6395477	6063497	90
6395934	3492023	71	6017160	6017160	127	5848264	6017170	126	6978663	6056157	74	5060413	6063950	77
6709656	3492024	71	5848264	6017170	126	5848271	6017171	126	6978762	6056203	74	6441372	/100 pc. 6065600	97
6709670	3492026	71	5848271	6017171	126	5848288	6017172	126	6114672	price/m 6056229	76	6065417	price/m 6067093	78
6411832	/100 pc. 3498326	70	6017171	6017171	126	5848295	6017173	126	6978847	price/m 6056408	74	6065530	6067115	78
6411856	3498334	70	5903468	6017173	126	6017173	6017173	126	6625215	price/m 6056423	76	6065592	6067123	85
6411870	3498340	70	5903475	6017175	126	6017175	6017175	126	6978885	price/m 6056505	74	6065653	6067131	91
6411894	3498350	70	6014293	6018378	54	6446896	6018505	51	6065899	price/m 6056520	76	6065899	6067603	78
5386056	5043107	125	6229154	6018513	47	6018513	6018513	47	6065950	price/m 6056602	74	6065950	6067611	78
6997992	6000117	122	5706007	6018517	47	6379392	6040403	81	6066018	price/m 6056636	74	6066018	6067654	78
6000012	price/m 6000118	122	6379392	6040403	81	6502639	6040411	81	6066070	price/m 6056644	74	6066070	6067662	78
6397655	6000122	128	6502639	6040411	81	6379453	6040438	81	6066131	price/m 6056652	74	6066131	6067816	85
6625819	6000150	122	6379453	6040438	81	6379514	6040446	81	6066193	price/m 6056679	74	6066193	6067913	91
6397662	6000190	128	6050415	6043208	80	6050475	6043216	80	6400690	price/m 6056744	75	6400690	6067948	91
5651758	6000209	128	6050475	6043216	80	6050536	6043224	80	5694724	price/m 6056746	75	5694724	6067970	78
6000135	6000304	122	6050536	6043224	80	6051014	6043402	81	6066315	price/m 6056679	76	6066315	6067972	79
6397679	6000331	128	6050598	6043232	80	6051076	6043410	81	6066377	price/m 6056695	74	6066377	6067980	85
6000197	6000401	122	6051014	6043402	81	6051137	6043429	81	6066438	price/m 6056717	74	6066438	6067999	91
6397686	6000451	128	6051137	6043429	81	6051199	6043437	81	6066490	price/m 6056733	74	6066490	6068022	79
6000258	6000509	122	6051199	6043437	81	6051618	6043607	82	6120550	price/m 6056735	75	6295579	price/100 6072895	71
6397693	6000515	128	6051618	6043607	82	6051670	6043615	82	6120673	price/m 6056737	75	6295395	6072909	71
6000319	6000606	122	6051670	6043615	82	6051731	6043623	82	6120734	price/m 6056742	75	6066618	price/m 6067654	78
6350896	6000770	122	6051731	6043623	82	6051793	6043631	82	6120796	price/m 6056744	75	6066618	6067654	78
6397709	6000775	128	6051793	6043631	82	6052219	6043755	79	6120857	price/m 6056746	75	6066618	6067662	78
6119776	6000904	122	6052219	6043755										



GTIN	Item no.	Page	GTIN	Item no.	Page	GTIN	Item no.	Page	GTIN	Item no.	Page	GTIN	Item no.	Page
6186730	6339077	53	6536177	6341632	49	6229277	6416446	47	5486602	6480102	105	5488682	6480436	108
6186792	6339093	53				5706045	6416448	47	5486619	6480103	105	5488743	6480451	117
6186853	6339115	53	6221776	6342302	46	6202751	6416489	51	5486626	6480104	105	5488750	6480452	117
6186914	6339131	53	6222018	6342304	46	6202812	6416500	51	5486633	6480105	105	5488767	6480453	117
6186976	6339166	53	6222070	6342306	46	6894253	6416504	52	5486640	6480106	105	5571254	6480454	117
6187034	6339182	53	6222315	6342308	46	5018346	6416507	52	5486657	6480111	105	5488774	6480455	117
6187096	6339190	53	6222377	6342310	46	6202874	6416519	54	5486671	6480113	113	5488781	6480461	110
6187157	6339204	53	6222438	6342312	46				5486688	6480121	108	5571261	6480462	110
6187218	6339212	53	6222490	6342314	46				5486695	6480122	108	5488798	6480463	110
6187270	6339220	53	6222510	6342316	46	6822133	6418248	47	5486701	6480123	108	5488804	6480464	110
6187331	6339239	53	6223572	6342318	46	6437474	6418250	47	5486718	6480124	108	5488811	6480465	110
6187393	6339247	53	6223633	6342328	46	6204434	6418287	55	5486725	6480125	108	5488828	6480466	110
6187454	6339255	53	6224296	6342338	46	6204557	6418317	55	5486756	6480126	108	5488897	6480482	117
6187515	6339263	53	5710905	6342340	46				5486831	6480142	114	5488903	6480483	117
6187577	6339271	53	6224470	6342351	45	6204731	6418554	60	5486848	6480143	114	5488910	6480484	117
6187638	6339298	53	6224531	6342353	45	6204793	6418570	60	5571100	6480144	114	5488927	6480485	117
6931217	6339334	53	6224593	6342355	45	6204854	6418597	60	5486879	6480145	114	5488934	6480486	117
6457458	6339360	53	6224654	6342357	45	6512010	6418607	60	5486886	6480146	114	5488941	6480491	109
			6224715	6342359	45	6204915	6418619	60	5486893	6480151	108	5488958	6480492	109
6187690	6340016	54	6224777	6342362	45	6205035	6418635	60	5571117	6480152	108	5488965	6480493	109
6187751	6340032	54	6225019	6342364	45	6205207	6418676	60	5486909	6480153	108	5488972	6480494	109
6187812	6340059	54	6225071	6342366	45	6512027	6418676	60	5486930	6480154	108	5488989	6480495	109
6187874	6340075	54	6225132	6342368	45	6205158	6418686	60	5486947	6480155	108	5488996	6480496	109
6187935	6340091	54	6225378	6342370	45	6205219	6418708	60	5486954	6480156	108	5489009	6480501	110
6187997	6340113	54	6225439	6342372	45	6205271	6418724	60	5486961	6480161	107	5489047	6480502	110
6188055	6340148	54	5705352	6342401	46	6206599	6419704	58	5486978	6480162	107	5489054	6480503	110
6188116	6340164	54	5705369	6342403	46	6206650	6419712	58	5486985	6480163	107	5489061	6480504	110
6188178	6340180	54	5705376	6342405	46	6206711	6419720	58	5486992	6480164	107	5489092	6480505	110
6188239	6340199	54	5705383	6342407	46	6206773	6419747	58	5487005	6480165	107	5489108	6480506	110
6188291	6340202	54	5705390	6342409	46	6206834	6419763	58	5487012	6480166	107	5489221	6480522	118
6188352	6340210	54	5705406	6342411	46	6206834	6419763	58	5487128	6480182	115	5489238	6480523	118
6188413	6340229	54	5705413	6342413	46	6483679	6419771	58	5487135	6480183	115	5489245	6480524	118
6188475	6340237	54	5705420	6342415	46	6206896	6419798	58	5487142	6480184	115	5489283	6480525	118
6188536	6340245	54	5705437	6342417	46	6206957	6419828	58	5487173	6480185	115	5489290	6480526	118
6188598	6340253	54	5705703	6342455	46	6512102	6419838	58	5487180	6480186	115	5489306	6480531	110
6188659	6340261	54	5705710	6342457	46	6512133	6419840	58	5487197	6480191	107	5489313	6480532	110
6188710	6340288	54	5705727	6342460	46	6512140	6419842	58	5487203	6480192	107	5489320	6480533	110
6188772	6340296	54	5705765	6342463	46	6207077	6420656	56	5487210	6480193	107	5489337	6480534	110
6188895	6340377	54	5705772	6342466	46	6207138	6420664	56	5487227	6480194	107	5571292	6480535	110
6959006	6340881	51				6207190	6420680	56	5487234	6480195	107	5489344	6480536	110
6959068	6340903	51	6190393	6343090	133	6207251	6420710	56	5487241	6480196	107	5491569	6480841	107
6959129	6340911	51	6190454	6343104	133	6207312	6420745	56	5487258	6480201	109	5491576	6480842	107
6959181	6340938	51				6207374	6420788	56	5487265	6480202	109	5491583	6480843	107
6601752	6340946	51	6340217	6348874	48	6207497	6420826	56	5487296	6480203	109	5491590	6480844	107
6043927	6340950	51	5706014	6348876	48				5487302	6480204	109	5491606	6480845	107
6044047	6340954	51	6168910	6348904	51	6207558	6421008	57	5487319	6480205	109	5491613	6480846	107
6044160	6340958	51	6901456	6348920	52	6207619	6421024	57	5487326	6480206	109	5491620	6480847	107
6284177	6340962	51	5018360	6348925	52	6207619	6421032	57	5487395	6480222	115	5491637	6480848	107
6437597	6340966	51	6437771	6348939	52	6207671	6421032	57	5487401	6480223	115	5491750	6480861	118
6437658	6340970	51				5061953	6421036	57	5487418	6480224	115	5491767	6480862	118
6446957	6340989	51	6191352	6349056	54	5061960	6421040	57	5571124	6480225	115	5491804	6480863	118
			6191475	6349153	54	5061977	6421044	57	5487425	6480226	115	5491811	6480864	118
6081615	6341105	51				6208876	6437109	132	5487432	6480231	111	5491828	6480865	118
6081677	6341109	51	6677696	6355798	61				5487449	6480232	111	5491866	6480866	118
6081738	6341113	51	6677702	6355805	61	6208937	6442803	59	5571131	6480233	111	5491873	6480867	118
6081790	6341117	51				6209057	6442838	59	5487456	6480234	111	5491880	6480868	118
6081851	6341121	51	6579075	6355808	61	6209118	6442854	59	5487463	6480235	111	5491897	6480871	106
6081912	6341125	51	6579259	6355812	61	6209170	6442870	59	5487470	6480236	111	5491903	6480872	106
6081974	6341129	51				6209233	6442897	59	5487753	6480281	109	5491910	6480873	106
6082094	6341133	51				6209293	6442919	59	5487760	6480282	109	5491927	6480874	106
6082155	6341137	51	6079032	6366090	132				5487777	6480283	109	5491934	6480875	106
6082216	6341141	51				5483120	6480001	104	5487784	6480284	109	5491941	6480876	106
6082278	6341152	51				5486213	6480002	104	5487791	6480285	109	5491989	6480877	106
6477135	6341358	50	6049080	6404006	71	5486220	6480003	104	5487807	6480286	109	5491996	6480878	106
6644230	6341362	50	6049202	6404014	71	5571063	6480004	104	5487890	6480302	116	5492177	6480895	119
6350292	6341366	50				5486237	6480005	104	5487906	6480303	116	5492184	6480897	119
6350414	6341370	50	6199815	6406122	68	5486244	6480006	104	5487913	6480304	116	5492191	6480899	119
6350476	6341374	50	5059585	6406125	68	5486329	6480022	112	5487920	6480305	116	5492207	6480901	119
6350537	6341378	50	6563111	6406130	68	5486336	6480023	112	5571179	6480306	116	5492214	6480903	119
6350599	6341382	50	5059561	6406133	68	5486366	6480024							

GTIN	Item no.	Page	GTIN	Item no.	Page	GTIN	Item no.	Page	GTIN	Item no.	Page	GTIN	Item no.	Page
5495055	6481342	114	5508090	6483313	111	6512560	6487122	142	6513819	6487506	138			
5495123	6481350	106	5508106	6483314	111	6512577	6487124	142	6513826	6487508	138	6211753	7001312	80
5495147	6481352	106	5508113	6483315	111	6512584	6487127	142	6513833	6487512	138	6818891	7001762	86
			5508120	6483316	111	6512614	6487129	142	6513840	6487514	138	6819317	7001789	86
5506454	6483031	105	5508199	6483332	116	6512621	6487132	142	6513871	6487516	138	6819379	7001800	86
5506461	6483032	105	5508205	6483333	116	6512638	6487134	142	6513888	6487518	138	6211999	7001819	87
5506492	6483033	105	5508243	6483334	116	6512645	6487136	142	6513895	6487532	141	6212057	7001835	87
5506508	6483034	105	5508250	6483335	116	6512676	6487202	136	6513901	6487534	141	6212118	7001851	87
5506515	6483035	105	5508267	6483336	116	6512683	6487204	136	6513932	6487536	141	6819430	7001894	92
5506522	6483036	105	5508953	6483431	108	6512690	6487206	136	6513949	6487538	141	6819492	7001916	92
5506638	6483052	113	5508960	6483432	108	6512706	6487208	136	6513956	6487540	141	6819553	7001932	92
5506645	6483053	113	5508977	6483433	108	6512737	6487212	136	6513963	6487544	141	6212354	7001940	93
5506652	6483054	113	5508984	6483434	108	6512744	6487214	136	6513994	6487552	141	6212415	7001967	93
5506669	6483055	113	5509011	6483435	108	6512751	6487216	136	6514007	6487554	141			
5506676	6483056	113	5509028	6483436	108	6512768	6487218	136	6514014	6487557	141	6212897	7002394	81
5506683	6483101	105	5509134	6483451	117	6512799	6487222	140	6514021	6487558	141	6212958	7002416	81
5506690	6483102	105	5509141	6483452	117	6512805	6487224	140	6514045	6487560	141	6213016	7002432	81
5506706	6483103	105	5509158	6483453	117	6512812	6487226	140	6514052	6487565	141	6819614	7002475	87
5506713	6483104	105	5509165	6483454	117	6512829	6487228	140	6514069	6487582	144	6819676	7002491	87
5506720	6483105	105	5509196	6483455	117	6512850	6487230	140	6514076	6487584	144	6819737	7002513	87
5506737	6483106	105	5571797	6483461	110	6512867	6487232	140	6514083	6487586	144	6213252	7002521	87
5506775	6483121	108	5509202	6483462	110	6512874	6487242	140	6514113	6487588	144	6213313	7002556	87
5506782	6483122	108	5509219	6483463	110	6512881	6487244	140	6514120	6487590	144	6213375	7002572	87
5506799	6483123	108	5509226	6483464	110	6512911	6487246	140	6514137	6487592	144	6819799	7002637	93
5506805	6483124	108	5509264	6483465	110	6512928	6487248	140	6514144	6487594	144	6819850	7002653	93
5506812	6483125	108	5509271	6483466	110	6512935	6487250	140	6514175	6487602	144	6819911	7002688	93
5506829	6483126	108	5509400	6483482	117	6512942	6487252	140	6514182	6487604	144	6213610	7002696	93
5506911	6483142	114	5509448	6483483	117	6512973	6487262	143	6514199	6487606	144	6213672	7002726	93
5506928	6483143	114	5509455	6483484	117	6512980	6487264	143	6514205	6487608	144			
5506935	6483144	114	5509462	6483485	117	6512997	6487266	143	6514236	6487610	144	6214150	7003390	82
5506942	6483145	114	5509509	6483486	117	6513000	6487268	143	6514243	6487612	144	6214211	7003412	82
5506973	6483146	114	5509516	6483491	109	6513031	6487270	143	6514250	6487614	144	6214273	7003439	82
5571711	6483151	114	5509523	6483492	109	6514830	6487271	143	6514267	6487662	137	6820153	7003633	94
5506980	6483152	114	5509561	6483493	109	6513048	6487272	143	6514298	6487664	137	6820214	7003668	94
5506997	6483153	114	5509578	6483494	109	6513055	6487282	143	6514304	6487666	137	6820276	7003684	94
5507000	6483154	114	5509585	6483495	109	6513062	6487284	143	6514311	6487668	137	6214877	7003692	94
5507031	6483155	114	5509622	6483496	109	6513093	6487286	143	6514328	6487672	137	6214938	7003714	94
5507048	6483156	114	5509639	6483501	110	6513109	6487288	143	6514359	6487674	137			
5507055	6483161	107	5509646	6483502	110	6513116	6487290	143	6514366	6487676	137	6215416	7004397	82
5507062	6483162	107	5509684	6483503	110	6514847	6487291	143	6514373	6487678	137	6215478	7004419	82
5507109	6483163	107	5509691	6483504	110	6511983	6487292	143	6514380	6487682	140	6215539	7004435	82
5507116	6483164	107	5509707	6483505	110	6513123	6487305	136	6514427	6487684	140	6820511	7004648	94
5507123	6483165	107	5509745	6483506	110	6513154	6487307	139	6514434	6487686	140	6820573	7004664	94
5507161	6483166	107	5509875	6483522	118	6513161	6487309	142	6514441	6487688	140	6820634	7004680	94
5507291	6483182	115	5509882	6483523	118	6513178	6487315	136	6514472	6487690	140	6216130	7004699	95
5507307	6483183	115	5509929	6483524	118	6513185	6487317	139	6514489	6487692	140	6216192	7004710	95
5507338	6483184	115	5509936	6483525	118	6513215	6487319	142	6514496	6487702	140			
5507345	6483185	115	5509943	6483526	118	6513222	6487325	137	6514502	6487704	140	5047322	7007005	83
5571728	6483186	115	5509981	6483531	110	6513239	6487327	139	6514533	6487706	140	5703730	7007006	83
5507352	6483191	107	5509988	6483532	110	6513246	6487329	142	6514540	6487708	140	5047339	7007009	83
5507369	6483192	107	5510000	6483533	110	6513277	6487335	137	6514557	6487710	140	5811015	7007010	83
5507390	6483193	107	5510048	6483534	110	6513284	6487337	139	6514564	6487712	140	5047346	7007013	83
5507406	6483194	107	5510055	6483535	110	6513291	6487339	142	6514595	6487722	143	5703747	7007014	83
5507413	6483195	107	5510062	6483536	110	6513307	6487352	137	6514601	6487724	143	5047377	7007017	83
5507420	6483196	107				6513314	6487354	139	6514618	6487727	143	5863342	7007018	83
5507437	6483201	109	5516668	6484331	106	6513321	6487356	142	6514625	6487728	143	5047384	7007021	83
5507444	6483202	109	5516712	6484335	114	6513338	6487362	137	6514663	6487730	143	5863380	7007022	83
5507451	6483203	109				6513345	6487364	139	6514670	6487732	143	6134519	7007024	83
5507468	6483204	109	6512157	6487002	136	6513352	6487366	142	6514687	6487735	143			
5507475	6483205	109	6512164	6487004	136	6513369	6487402	137	6514717	6487743	143	5047391	7007025	83
5507482	6483206	109	6512195	6487007	136	6513390	6487404	137	6514724	6487744	143	5863397	7007026	83
5507543	6483222	115	6512201	6487009	136	6513406	6487406	137	6514731	6487746	143	5047407	7007029	83
5507550	6483223	115	6512218	6487012	136	6513413	6487408	137	6514748	6487748	143	5863403	7007030	83
5507567	6483224	115	6512225	6487014	136	6513420	6487412	137	6514786	6487751	143	6134526	7007035	83
5507574	6483225	115	6512256	6487017	136	6513468	6487414	137	6514793	6487752	143	6132423	7007036	83
5507581	6483226	115	6512263	6487019	136	6513475	6487416	137	6514809	6487754	143			
5507598	6483231	111	6512270	6487032	139	6513482	6487418	137						
5571742	6483232	111	6512287	6487034	139	6513529	6487422	140						



GTIN	Item no.	Page	GTIN	Item no.	Page	GTIN	Item no.	Page	GTIN	Item no.	Page	GTIN	Item no.	Page
	/pc.			/pc.			/pc.			/pc.			/pc.	
5688556	7007105	83	6991341	7068212	92	6812356	7117116	81	6845651	7128622	101	6820870	7134122	80
5995678	7007107	83	6991402	7068328	92	6901692	7117162	81	6249497	7128630	101	6820931	7134130	80
5886181	7007109	83	6225552	7068409	92	6812417	7117209	81	6249558	7128657	101	6820993	7134138	80
5886198	7007113	83	6225613	7068506	92	6812479	7117306	81	6249619	7128673	101	6254712	7134231	80
5886204	7007117	83				6245055	7117396	82	6249671	7128703	101	6254774	7134258	80
5886235	7007119	83	6079971	7070205	96	6962785	7117477	82	6249794	7128738	101	6254835	7134266	80
5886242	7007121	83	6094820	7070209	96				6249855	7128819	98	6254897	7134908	99
5688563	7007155	83	6094882	7070213	96	6245116	7117507	82	6526338	7128827	98	6254958	7134916	99
5995654	7007156	83	6094943	7070217	96	6245178	7117604	82	6249916	7128835	98	6255016	7134924	99
5886112	7007157	83	6095001	7070221	96	5920038	7117606	82	6249978	7128851	98	6255078	7134932	99
5886129	7007159	83	6095063	7070225	96	5920045	7117608	82	6250035	7128886	99	6255139	7134940	99
5886136	7007161	83	6095186	7070233	96				6250097	7128908	99	6255191	7134967	99
5886143	7007163	83	6095728	7070353	96				6250219	7128924	99			
5886174	7007165	83	6095780	7070361	96	6812714	7119119	94				6821235	7136120	81
5711537	7007230	88	6095841	7070365	96	6812776	7119216	94	6250752	7129610	99	6821297	7136133	81
5863502	7007231	88	6095902	7070369	96	6812837	7119313	94	6526451	7129629	99	6821358	7136141	81
5711544	7007234	88	6095964	7070373	96	6245772	7119402	94	6250813	7129637	99	6256877	7136242	81
5863519	7007235	88	6096022	7070381	96	6245833	7119496	94	6250875	7129653	99	6256938	7136250	81
5711575	7007238	88							6250936	7129688	99	6256990	7136269	81
5863526	7007239	88	6230112	7081103	96	6813131	7121109	81	6250998	7129718	99	6257058	7136900	100
5711582	7007242	88	6230174	7081200	96	6027002	7121205	81	6251117	7129734	99	6257119	7136919	100
5863564	7007243	88	6230235	7081308	96	6813193	7121210	81				6257171	7136927	100
5711599	7007246	88	6230297	7081405	96	6813254	7121318	81	5047568	7130805	102	6257232	7136935	100
5863571	7007247	88	6230358	7081502	96	6246373	7121407	81	5047575	7130809	102	6257294	7136943	100
5711605	7007250	88	5995883	7081555	96	6246434	7121504	81	5047582	7130813	102	6257355	7136978	100
5863588	7007251	88				6246496	7121601	81	5047612	7130817	102			
5711636	7007270	88	6230532	7082010	78	6329687	7121609	81	5047629	7130821	102			
5863410	7007271	88	6230594	7082029	85				5047636	7130825	102			
5711643	7007274	88	6230655	7082037	91				5047643	7130829	102			
5863427	7007275	88	6230778	7082223	78	6813315	7122109	87	5047681	7130852	102			
5711650	7007278	88	6230839	7082258	78	6813377	7122213	87	5047698	7130856	102			
5863434	7007279	88	6230891	7082320	85	6813438	7122310	87	5047704	7130860	102			
5711667	7007282	88	6230952	7082436	91	6246731	7122403	87	5047735	7130864	102			
5863441	7007283	88	6986361	7082479	91	6246793	7122500	87	5047742	7130868	102			
5711698	7007286	88				6246854	7122608	87	5047759	7130872	102			
5863458	7007287	88	6146895	7084773	97				5047766	7130876	102			
5711704	7007290	88				6813490	7123116	93	5688600	7130905	102			
5863465	7007291	88	5166320	7085133	97	6813551	7123213	93	5995791	7130906	102			
5711711	7007310	95				6813674	7123310	93	5886303	7130907	102			
5711728	7007314	95	6241637	7109105	79	6247097	7123396	93	5886327	7130909	102			
5711759	7007318	95	6241699	7109156	79	6247158	7123507	93	5886365	7130911	102			
5863618	7007319	95	6241750	7109202	79				5886389	7130913	102			
5711766	7007322	95	6241811	7109296	79	6814091	7125100	80	5886419	7130915	102			
5711773	7007326	95	6241873	7109407	79	6901753	7125189	80	5688617	7130952	102			
5863625	7007327	95	6241934	7109504	79	6814152	7125220	80	5995814	7130953	102			
5995586	7007333	95	6241996	7109601	79	6814336	7125305	80	5886259	7130954	102			
5995609	7007334	95	6242054	7109814	79	6247691	7125410	80	5886266	7130956	102			
5711810	7007350	95	5981084	7109816	79	6962907	7125461	80	5886273	7130958	102			
5711827	7007354	95	6242115	7109830	79				5886280	7130960	102			
5711834	7007358	95	6242177	7109857	79	6247752	7125526	80	5886297	7130962	102			
5863649	7007359	95	6242238	7109873	79	6247813	7125585	80	5711964	7130990	102			
5711841	7007362	95	6242290	7109903	79	5919964	7125586	80	5711995	7130994	102			
5711872	7007366	95	6242351	7109938	79	5919971	7125588	80	5712008	7130998	102			
5863687	7007367	95												
5995623	7007373	95	6242412	7110103	85				5712015	7131002	102			
5995647	7007374	95	6242474	7110200	85	6814510	7126127	86	5712022	7131006	102			
5850908	7007398	95	6242535	7110308	85	6814572	7126216	86	5712039	7131010	102			
5809197	7007400	95	6242597	7110405	85	6814633	7126301	86	5712046	7131030	103			
5809203	7007404	95	6242658	7110502	85	6248056	7126417	87	5995753	7131032	103			
5850922	7007468	95	6242719	7110618	85	6248117	7126514	87	5712053	7131034	103			
5809210	7007470	95				6248179	7126611	87	5712060	7131038	103			
5809227	7007474	95	6242771	7111096	91				5712077	7131042	103			
			6242894	7111207	91	6814695	7127103	92	5712084	7131046	103			
6990924	7066112	79	6243013	7111304	91	6814756	7127227	92	5995760	7131052	103			
6901579	7066158	79	6243136	7111428	91	6814817	7127320	92						
6990986	7066228	79	6243198	7111509	91	6248414	7127413	93	6923595	7132002	98			
6991044	7066317	79	5995517	7111740	91	6248476	7127499	93	6923656	7132004	98			
6224838	7066406	80				6935475	7127627	93	6923717	7132006	98			
6962488	7066457	80	6991709	7113110	82				6924073	7132022	99			
			6991761	7113218	82	6248599	7128215	100	6924134	7132024	99			
6224890	7066503	80	6991822	7113315	82	6526031	7128223	100	6924196	7132026	99			
6224951	7066600	80	6243730	7113404	82	6248650	7128231	100						
6127863	7066720	80	6243792	7113501	82	6248711	7128266	100	6820696	7133107	79			
6127979	7066729	80	6243853	7113609	82	6248773	7128282	101	6820757	7133120	79			
			5919988	7113611	82	6248834	7128304	101	6820818	7133142	79			
			5920021	7113613	82	6248957	7128320	101	6253630	7133235	80			
						6249015	7128428	100	6253692	7133243	80			
6991105	7067119	86				6526154	7128436	100						



Type	GTIN	Item no.	Page
939	5386056	/100 pc. 5043107	125
966 M8 F	5300793	3402452	69
AML3518P2000FT	5047599	price/100 1119656	62
AML3518UP2000FT	5047056	1118129	62
AMS3518P2000FT	5632535	1112759	62
AW 15 11 A2	6207558	/pc. 6421008	57
AW 15 11 FT	6207077	6420656	56
AW 15 16 FT	6207138	6420664	56
AW 15 21 A2	6207619	6421024	57
AW 15 21 FT	6207190	6420680	56
AW 15 31 A2	6207671	6421032	57
AW 15 31 FT	6207251	6420710	56
AW 15 41 A2	5061953	6421036	57
AW 15 41 FT	6207312	6420745	56
AW 15 51 A2	5061960	6421040	57
AW 15 51 FT	6207374	6420788	56
AW 15 61 A2	5061977	6421044	57
AW 15 61 FT	6207497	6420826	56
AW 30 101 FT	6512140	6419842	58
AW 30 11 A2	6208937	6442803	59
AW 30 11 FT	6206599	6419704	58
AW 30 16 FT	6206650	6419712	58
AW 30 21 A2	6209057	6442838	59
AW 30 21 FT	6206711	6419720	58
AW 30 31 A2	6209118	6442854	59
AW 30 31 FT	6206773	6419747	58
AW 30 41 A2	6209170	6442870	59
AW 30 41 FT	6206834	6419763	58
AW 30 46 FT	6483679	6419771	58
AW 30 51 A2	6209231	6442897	59
AW 30 51 FT	6206896	6419798	58
AW 30 61 A2	6209293	6442919	59
AW 30 61 FT	6206957	6419828	58
AW 30 76 FT	6512102	6419838	58
AW 30 91 FT	6512133	6419840	58
AW 55 101 FT	6205271	6418724	60
AW 55 21 FT	6204731	6418554	60
AW 55 31 FT	6204793	6418570	60
AW 55 41 FT	6204854	6418597	60
AW 55 46 FT	6512010	6418607	60
AW 55 51 FT	6204915	6418619	60
AW 55 61 FT	6205035	6418635	60
AW 55 76 FT	6512027	6418676	60
AW 55 81 FT	6205158	6418686	60
AW 55 91 FT	6205219	6418708	60
BFK 153 33 FT	6079896	6003884	61
BFK 187 33 FT	6079919	6003892	61
BZ 12-15-35/110	6411894	/100 pc. 3498350	70
BZ-U 10-10-30/90	6411856	3498334	70
BZ-U 8-30-41/95	6411832	3498326	70
BZ-U10-30-50/110	6411870	3498340	70
CM3015P2000FT	5041771	price/100 1109871	62
CSTR M10 G	6202270	/100 pc. 6410103	44
CSTR M12 G	6202331	6410111	44
CSTR M8 G	6202218	6410081	44
DBL 50 100 FS	6746118	/pc. 6015506	44
DBL 50 100 FT	6785414	6015565	44
DBL 50 150 FS	6746170	6015514	44
DBL 50 150 FT	6785476	6015573	44
DBL 50 200 FS	6746231	6015522	44
DBL 50 200 FT	6785537	6015581	44
DBL 50 300 FS	6746293	6015530	44
DBL 50 300 FT	6785599	6015603	44
DBL 50 400 FS	6746354	6015549	44
DBL 50 400 FT	6785650	6015611	44
DBL 50 500 FS	5239154	6015552	44

Type	GTIN	Item no.	Page
DBL 50 500 FT	5239208	/pc. 6015614	44
DBL 50 600 FS	5239161	6015555	44
DBL 50 600 FT	5239215	6015617	44
DBLG 20 050 FS	6961528	6015646	133
DBLG 20 050 FT	6042845	6015648	133
DBLG 20 100 FS	6961580	6015654	133
DBLG 20 100 FT	6042968	6015656	133
DBLG 20 150 FS	6279371	6015658	133
DBLG 20 150 FT	6043088	6015660	133
DBLG 20 200 FS	6961641	6015662	133
DBLG 20 200 FT	6043200	6015664	133
DBLG 20 300 FS	6961702	6015670	133
DBLG 20 300 FT	6043323	6015672	133
DBLG 20 400 FS	6961764	6015689	133
DBLG 20 400 FT	6043446	6015691	133
DBLG 20 500 FS	5239222	6015693	133
DBLG 20 500 FT	5239260	6015695	133
DBLG 20 600 FS	5239277	6015697	133
DBLG 20 600 FT	5239284	6015699	133
DBV 100 S A2	5688600	7130905	102
DBV 100 S FS	5047568	7130805	102
DBV 110 100 F FS	5712046	7131030	103
DBV 110 150 F FS	5995753	7131032	103
DBV 110 200 F FS	5712053	7131034	103
DBV 110 300 F FS	5712060	7131038	103
DBV 110 400 F FS	5712077	7131042	103
DBV 110 500 F FS	5712084	7131046	103
DBV 110 600 F FS	5995760	7131052	103
DBV 150 S A2	5995791	7130906	102
DBV 150 S FS	5047575	7130809	102
DBV 200 S A2	5886303	7130907	102
DBV 200 S FS	5047582	7130813	102
DBV 300 S A2	5886327	7130909	102
DBV 300 S FS	5047612	7130817	102
DBV 400 S A2	5886365	7130911	102
DBV 400 S FS	5047629	7130821	102
DBV 500 S A2	5886389	7130913	102
DBV 500 S FS	5047636	7130825	102
DBV 60 100 F A2	5688617	7130952	102
DBV 60 100 F FS	5047681	7130852	102
DBV 60 150 F A2	5995814	7130953	102
DBV 60 150 F FS	5047698	7130856	102
DBV 60 200 F A2	5886259	7130954	102
DBV 60 200 F FS	5047704	7130860	102
DBV 60 300 F A2	5886266	7130956	102
DBV 60 300 F FS	5047735	7130864	102
DBV 60 400 F A2	5886273	7130958	102
DBV 60 400 F FS	5047742	7130868	102
DBV 60 500 F A2	5886280	7130960	102
DBV 60 500 F FS	5047759	7130872	102
DBV 60 600 F A2	5886297	7130962	102
DBV 60 600 F FS	5047766	7130876	102
DBV 600 S A2	5886419	7130915	102
DBV 600 S FS	5047643	7130829	102
DBV 85 100 F FS	5711964	7130990	102
DBV 85 200 F FS	5711995	7130994	102
DBV 85 300 F FS	5712008	7130998	102
DBV 85 400 F FS	5712015	7131002	102
DBV 85 500 F FS	5712022	7131006	102
DBV 85 600 F FS	5712039	7131010	102
DFAA 100 A2	6257058	7136900	100
DFAA 100 FS	6249015	7128428	100
DFAA 150 FS	6526154	7128436	100
DFAA 200 A2	6257119	7136919	100
DFAA 200 FS	6249077	7128444	100
DFAA 300 A2	6257171	7136927	100
DFAA 300 FS	6249138	7128460	100
DFAA 400 A2	6257232	7136935	100
DFAA 400 FS	6249190	7128487	100
DFAA 500 A2	6257294	7136943	100
DFAA 500 FS	6249251	7128509	100
DFAA 600 A2	6257355	7136978	100
DFAA 600 FS	6249374	7128525	100
DFB 45 100 A2	6253814	7133901	98
DFB 45 100 FS	6249855	7128819	98
DFB 45 100 FT	6923595	7132002	98
DFB 45 150 FS	6526338	7128827	98
DFB 45 200 A2	6253876	7133928	98
DFB 45 200 FS	6249916	7128835	98
DFB 45 200 FT	6923656	7132004	98



Type	GTIN	Item no.	Page
DFB 45 300 A2	6253937	7133936	98
DFB 45 300 FS	6249978	7128851	98
DFB 45 300 FT	6923717	7132006	98
DFB 45 400 A2	6253999	7133944	99
DFB 45 400 FS	6250035	7128886	99
DFB 45 500 FS	6250097	7128908	99
DFB 45 600 A2	6254118	7133979	99
DFB 45 600 FS	6250219	7128924	99
DFB 90 100 A2	6254897	7134908	99
DFB 90 100 FS	6250752	7129610	99
DFB 90 100 FT	6924073	7132022	99
DFB 90 150 FS	6526451	7129629	99
DFB 90 200 A2	6254958	7134916	99
DFB 90 200 FS	6250813	7129637	99
DFB 90 200 FT	6924134	7132024	99
DFB 90 300 A2	6255016	7134924	99
DFB 90 300 FS	6250875	7129653	99
DFB 90 300 FT	6924196	7132026	99
DFB 90 400 A2	6255078	7134932	99
DFB 90 400 FS	6250936	7129688	99
DFB 90 500 A2	6255139	7134940	99
DFB 90 500 FS	6250998	7129718	99
DFB 90 600 A2	6255191	7134967	99
DFB 90 600 FS	6251117	7129734	99
DFK 100 FS	6249435	7128614	101
DFK 150 FS	6845651	7128622	101
DFK 200 FS	6249497	7128630	101
DFK 300 FS	6249558	7128657	101
DFK 400 FS	6249619	7128673	101
DFK 500 FS	6249671	7128703	101
DFK 600 FS	6249794	7128738	101
DFT 100 FS	6248599	7128215	100
DFT 150 FS	6526031	7128223	100
DFT 200 FS	6248650	7128231	100
DFT 300 FS	6248711	7128266	100
DFT 400 FS	6248773	7128282	101
DFT 500 FS	6248834	7128304	101
DFT 600 FS	6248957	7128320	101
DIN934 M8 F	5298458	3400352	69
DKU A2	6441372	6065600	97
DKU A2	6441372	6065600	126
DRL 100 A2	6058877	6052878	98
DRL 100 FS	6057979	6052096	98
DRL 100 FT	6432370	6051340	98
DRL 150 A2	5995838	6052886	98
DRL 150 FS	6058099	6052150	98
DRL 150 FT	6432257	6051359	98
DRL 200 A2	6058938	6052894	145
DRL 200 FS	6058150	6052207	145
DRL 200 FT	6058150	6052207	98
DRL 200 FT	6611898	6051367	98
DRL 300 A2	6058990	6052908	145
DRL 300 A2	6058990	6052908	98
DRL 300 FS	6058273	6052304	145
DRL 300 FS	6058273	6052304	98
DRL 300 FT	6611775	6051383	98
DRL 400 A2	6059058	6052932	145
DRL 400 A2	6059058	6052932	98
DRL 400 FS	6058396	6052401	145
DRL 400 FS	6058396	6052401	98
DRL 400 FT	6611713	6051413	98
DRL 450 FT	5460145	6052450	98
DRL 500 A2	6059119	6052959	145
DRL 500 A2	6059119	6052959	98
DRL 500 FS	6058518	6052509	145
DRL 500 FS	6058518	6052509	98
DRL 500 FT	6087792	6051448	98
DRL 600 A2	6059171	6052975	145
DRL 600 A2	6059171	6052975	98
DRL 600 FS	6058754	6052606	145
DRL 600 FS	6058754	6052606	98
DRL 600 FT	6595631	6051472	98
DRLU 050 A2	6031818	6052821	97
DRLU 050 A2	6031818	6052821	126

Type	GTIN	Item no.	Page
DRLU 050 FS	6029655	6052056	97
DRLU 050 FS	6029655	6052056	126
DRLU 100 A2	6031931	6052824	97
DRLU 100 A2	6031931	6052824	126
DRLU 100 FS	6029716	6052103	97
DRLU 100 FS	6029716	6052103	126
DRLU 150 A2	6031993	6052828	97
DRLU 150 A2	6031993	6052828	126
DRLU 150 FS	6030019	6052153	97
DRLU 150 FS	6030019	6052153	126
DRLU 200 A2	6032051	6052831	97
DRLU 200 A2	6032051	6052831	126
DRLU 200 FS	6030071	6052210	97
DRLU 200 FS	6030071	6052210	126
DRLU 300 A2	6032174	6052834	97
DRLU 300 A2	6032174	6052834	126
DRLU 300 FS	6031399	6052307	97
DRLU 300 FS	6031399	6052307	126
DRLU 400 A2	6032235	6052837	97
DRLU 400 A2	6032235	6052837	126
DRLU 400 FS	6031511	6052405	97
DRLU 400 FS	6031511	6052405	126
DRLU 500 A2	6032297	6052841	97
DRLU 500 A2	6032297	6052841	126
DRLU 500 FS	6031634	6052512	97
DRLU 500 FS	6031634	6052512	126
DRLU 600 A2	6032358	6052844	97
DRLU 600 A2	6032358	6052844	126
DRLU 600 FS	6031757	6052609	97
DRLU 600 FS	6031757	6052609	126
DSK 25 A2	5706045	6416448	47
DSK 25 FT	6229277	6416446	47
DSK 45 A2	6202751	6416489	51
DSK 45 A2	6202751	6416489	55
DSK 45 FT	6202812	6416500	51
DSK 45 FT	6202812	6416500	55
DSK 47 A2	5018346	6416507	52
DSK 47 FT	6894253	6416504	52
DSK 61 FT	6202874	6416519	54
EKL 25 M6	6049080	6404006	71
EKL 25 M6	6049080	6404006	125
EKL 35 M6	6049202	6404014	71
EKL 35 M6	6049202	6404014	125
EKS 610 FS	6542659	6056148	76
EKS 610 FT	6333677	6056776	76
EKS 620 FS	6114672	6056229	76
EKS 620 FT	6333738	6056792	76
EKS 630 FS	6389834	6056326	76
EKS 630 FT	6333790	6056806	76
EKS 640 FS	6625215	6056423	76
EKS 640 FT	6333493	6056970	76
EKS 645 FT	6963027	6056978	76
EKS 650 FS	6625277	6056520	76
EKS 650 FT	6333554	6056989	76
EKS 660 FS	6389896	6056628	76
EKS 660 FT	6333615	6056997	76
EKS 675 FT	5919926	6056996	76
EKS 690 FT	5919957	6056998	76
ES M 10x40	6709656	3492024	71
ES M 12x50	6709670	3492026	71
ES M 8x30	6395934	3492023	71
FRS 10x25 F 8.8	6201914	6407560	47
FRS 10x25 F 8.8	6201914	6407560	52
FRS 10x25 F 8.8	6201914	6407560	68
FRS 8x16 F 5.6	6201198	6406939	68
FRS 8x16 F 8.8	6201259	6406963	68
FRS 8x20 F	6201310	6406971	68
FRS 8x25 F	6201372	6406998	68
FRS 8x35 F	6201433	6407048	68
FRSB 6x12 A2	6077595	6406138	68
FRSB 6x12 F	6199815	6406122	68
FRSB 6x12 G	6563111	6406130	68
FRSB 6x12 VZ F	5059585	6406125	68

Type	GTIN	Item no.	Page
		/100 pc.	
FRSB 6x12 VZ G	5059561	6406133	68
FRSB 6x20 F	6199990	6406203	68
FRSB 6x30 F	5045243	6406907	145
FRSB 6x30 F	5045243	6406907	68
GDRL 100 FS	5571087	6480101	105
GDRL 100 FS	5571087	6480101	113
GDRL 100 FT	5506683	6483101	105
GDRL 100 FT	5506683	6483101	113
GDRL 150 FS	5486602	6480102	105
GDRL 150 FS	5486602	6480102	113
GDRL 150 FT	5506690	6483102	105
GDRL 150 FT	5506690	6483102	113
GDRL 200 FS	5486619	6480103	105
GDRL 200 FS	5486619	6480103	113
GDRL 200 FT	5506706	6483103	105
GDRL 200 FT	5506706	6483103	113
GDRL 300 FS	5486626	6480104	105
GDRL 300 FS	5486626	6480104	113
GDRL 300 FT	5506713	6483104	105
GDRL 300 FT	5506713	6483104	113
GDRL 400 FS	5486633	6480105	105
GDRL 400 FS	5486633	6480105	113
GDRL 400 FT	5506720	6483105	105
GDRL 400 FT	5506720	6483105	113
GDRL 500 FS	5486640	6480106	105
GDRL 500 FS	5486640	6480106	113
GDRL 500 FT	5506737	6483106	105
GDRL 500 FT	5506737	6483106	113
		/pc.	
GEV 36 A2	6013333	6016731	124
GEV 36 FT	6013272	6016723	124
GEV 36 G	6307876	6016715	124
GKS 34 A2	6013456	6016839	124
GKS 34 FT	6013395	6016820	124
GKS 34 G	7261436	6016855	124
GKS 50 07 FS	6421398	6015263	125
GKS 50 07 FT	6785353	6015271	125
GKS 50 11 A4	6937394	6015280	125
GKS 50 11 FS	6965847	6015276	125
GKS 50 11 FT	6965908	6015278	125
GKS FL 115 FS	5486329	6480022	112
GKS FL 120 FS	5486336	6480023	112
GKS FL 130 FS	5486343	6480024	112
GKS FL 140 FS	5486350	6480025	112
GKS FL 150 FS	5486367	6480026	112
GKS FL 610 FS	5483120	6480001	104
GKS FL 615 FS	5486213	6480002	104
GKS FL 620 FS	5486220	6480003	104
GKS FL 630 FS	5571063	6480004	104
GKS FL 640 FS	5486237	6480005	104
GKS FL 650 FS	5486244	6480006	104
GKS GX 115 FS	5486558	6480052	113
GKS GX 115 FT	5506638	6483052	113
GKS GX 120 FS	5486565	6480053	113
GKS GX 120 FT	5506645	6483053	113
GKS GX 130 FS	5486572	6480054	113
GKS GX 130 FT	5506652	6483054	113
GKS GX 140 FS	5486589	6480055	113
GKS GX 140 FT	5506669	6483055	113
GKS GX 150 FS	5486596	6480056	113
GKS GX 150 FT	5506676	6483056	113
GKS GX 610 FS	5486398	6480031	105
GKS GX 610 FT	5506454	6483031	105
GKS GX 615 FS	5486404	6480032	105
GKS GX 615 FT	5506461	6483032	105
GKS GX 620 FS	5486411	6480033	105
GKS GX 620 FT	5506492	6483033	105
GKS GX 630 FS	5486428	6480034	105
GKS GX 630 FT	5506508	6483034	105
GKS GX 640 FS	5486459	6480035	105
GKS GX 640 FT	5506515	6483035	105
GKS GX 650 FS	5486466	6480036	105
GKS GX 650 FT	5506522	6483036	105
GKS TC 115 FS	5494645	6481295	114
GKS TC 120 FS	5494683	6481297	114
GKS TC 130 FS	5494690	6481299	114
GKS TC 140 FS	5494706	6481301	114
GKS TC 150 FS	5494744	6481303	114
GKS TC 610 FS	5494430	6481271	106
GKS TC 615 FS	5494447	6481273	106
GKS TC 620 FS	5494454	6481275	106

Type	GTIN	Item no.	Page
GKS TC 630 FS	5494461	6481277	106
GKS TC 640 FS	5494508	6481279	106
GKS TC 650 FS	5494515	6481281	106
GKSAA 115 FS	5488743	6480451	117
GKSAA 115 FT	5509134	6483451	117
GKSAA 120 FS	5488750	6480452	117
GKSAA 120 FT	5509141	6483452	117
GKSAA 130 FS	5488767	6480453	117
GKSAA 130 FT	5509158	6483453	117
GKSAA 140 FS	5571254	6480454	117
GKSAA 140 FT	5509165	6483454	117
GKSAA 150 FS	5488774	6480455	117
GKSAA 150 FT	5509196	6483455	117
GKSAA 610 FS	5488637	6480431	108
GKSAA 610 FT	5508953	6483431	108
GKSAA 615 FS	5488644	6480432	108
GKSAA 615 FT	5508960	6483432	108
GKSAA 620 FS	5488651	6480433	108
GKSAA 620 FT	5508977	6483433	108
GKSAA 630 FS	5488668	6480434	108
GKSAA 630 FT	5508984	6483434	108
GKSAA 640 FS	5488675	6480435	108
GKSAA 640 FT	5509011	6483435	108
GKSAA 650 FS	5488682	6480436	108
GKSAA 650 FT	5509028	6483436	108
GKSB 45 115 FS	5487128	6480182	115
GKSB 45 115 FT	5507291	6483182	115
GKSB 45 120 FS	5487135	6480183	115
GKSB 45 120 FT	5507307	6483183	115
GKSB 45 130 FS	5487142	6480184	115
GKSB 45 130 FT	5507338	6483184	115
GKSB 45 140 FS	5487173	6480185	115
GKSB 45 140 FT	5507345	6483185	115
GKSB 45 150 FS	5487180	6480186	115
GKSB 45 150 FT	5571728	6483186	115
GKSB 45 610 FS	5486961	6480161	107
GKSB 45 610 FT	5507055	6483161	107
GKSB 45 615 FS	5486978	6480162	107
GKSB 45 615 FT	5507062	6483162	107
GKSB 45 620 FS	5486985	6480163	107
GKSB 45 620 FT	5507109	6483163	107
GKSB 45 630 FS	5486992	6480164	107
GKSB 45 630 FT	5507116	6483164	107
GKSB 45 640 FS	5487005	6480165	107
GKSB 45 640 FT	5507123	6483165	107
GKSB 45 650 FS	5487012	6480166	107
GKSB 45 650 FT	5507161	6483166	107
GKSB 90 115 FS	5486831	6480142	114
GKSB 90 115 FT	5506911	6483142	114
GKSB 90 120 FS	5486848	6480143	114
GKSB 90 120 FT	5506928	6483143	114
GKSB 90 130 FS	5571100	6480144	114
GKSB 90 130 FT	5506935	6483144	114
GKSB 90 140 FS	5486879	6480145	114
GKSB 90 140 FT	5506942	6483145	114
GKSB 90 150 FS	5486886	6480146	114
GKSB 90 150 FT	5506973	6483146	114
GKSB 90 610 FS	5486688	6480121	108
GKSB 90 610 FT	5506775	6483121	108
GKSB 90 615 FS	5486695	6480122	108
GKSB 90 615 FT	5506782	6483122	108
GKSB 90 620 FS	5486701	6480123	108
GKSB 90 620 FT	5506799	6483123	108
GKSB 90 630 FS	5486718	6480124	108
GKSB 90 630 FT	5506805	6483124	108
GKSB 90 640 FS	5486725	6480125	108
GKSB 90 640 FT	5506812	6483125	108
GKSB 90 650 FS	5486756	6480126	108
GKSB 90 650 FT	5506829	6483126	108
GKSBV 90115F FS	5487890	6480302	116
GKSBV 90115F FT	5508021	6483302	116
GKSBV 90115S FS	5487395	6480222	115
GKSBV 90115S FT	5507543	6483222	115
GKSBV 90120F FS	5487906	6480303	116
GKSBV 90120F FT	5508038	6483303	116
GKSBV 90120S FS	5487401	6480223	115
GKSBV 90120S FT	5507550	6483223	115
GKSBV 90130F FS	5487913	6480304	116
GKSBV 90130F FT	5508045	6483304	116
GKSBV 90130S FS	5487418	6480224	115
GKSBV 90130S FT	5507567	6483224	115
GKSBV 90140F FS	5487920	6480305	116
GKSBV 90140F FT	5508052	6483305	116



Type	GTIN	Item no.	Page
GKSBV 90140S FS	5571124	6480225	115
GKSBV 90140S FT	5507574	6483225	115
GKSBV 90150F FS	5571179	6480306	116
GKSBV 90150F FT	5508069	6483306	116
GKSBV 90150S FS	5487425	6480226	115
GKSBV 90150S FT	5507581	6483226	115
GKSBV 90610F FS	5487753	6480281	109
GKSBV 90610F FT	5507895	6483281	109
GKSBV 90610S FS	5487258	6480201	109
GKSBV 90610S FT	5507437	6483201	109
GKSBV 90615F FS	5487760	6480282	109
GKSBV 90615F FT	5507901	6483282	109
GKSBV 90615S FS	5487265	6480202	109
GKSBV 90615S FT	5507444	6483202	109
GKSBV 90620F FS	5487777	6480283	109
GKSBV 90620F FT	5507932	6483283	109
GKSBV 90620S FS	5487296	6480203	109
GKSBV 90620S FT	5507451	6483203	109
GKSBV 90630F FS	5487784	6480284	109
GKSBV 90630F FT	5507949	6483284	109
GKSBV 90630S FS	5487302	6480204	109
GKSBV 90630S FT	5507468	6483204	109
GKSBV 90640F FS	5487791	6480285	109
GKSBV 90640F FT	5507956	6483285	109
GKSBV 90640S FS	5487319	6480205	109
GKSBV 90640S FT	5507475	6483205	109
GKSBV 90650F FS	5487807	6480286	109
GKSBV 90650F FT	5507963	6483286	109
GKSBV 90650S FS	5487326	6480206	109
GKSBV 90650S FT	5507482	6483206	109
GKSDB 45 100 FS	5487197	6480191	107
GKSDB 45 100 FS	5487197	6480191	115
GKSDB 45 100 FT	5507352	6483191	107
GKSDB 45 150 FS	5487203	6480192	107
GKSDB 45 150 FS	5487203	6480192	115
GKSDB 45 150 FT	5507369	6483192	115
GKSDB 45 150 FT	5507369	6483192	107
GKSDB 45 200 FS	5487210	6480193	107
GKSDB 45 200 FS	5487210	6480193	115
GKSDB 45 200 FT	5507390	6483193	115
GKSDB 45 200 FT	5507390	6483193	107
GKSDB 45 300 FS	5487227	6480194	107
GKSDB 45 300 FS	5487227	6480194	115
GKSDB 45 300 FT	5507406	6483194	115
GKSDB 45 300 FT	5507406	6483194	107
GKSDB 45 400 FS	5487234	6480195	107
GKSDB 45 400 FS	5487234	6480195	115
GKSDB 45 400 FT	5507413	6483195	115
GKSDB 45 400 FT	5507413	6483195	107
GKSDB 45 500 FS	5487241	6480196	107
GKSDB 45 500 FS	5487241	6480196	115
GKSDB 45 500 FT	5507420	6483196	115
GKSDB 45 500 FT	5507420	6483196	107
GKSDB 90 100 FS	5486893	6480151	108
GKSDB 90 100 FS	5486893	6480151	114
GKSDB 90 100 FT	5571711	6483151	114
GKSDB 90 150 FS	5571117	6480152	108
GKSDB 90 150 FS	5571117	6480152	114
GKSDB 90 150 FT	5506980	6483152	114
GKSDB 90 200 FS	5486909	6480153	108
GKSDB 90 200 FS	5486909	6480153	114
GKSDB 90 200 FT	5506997	6483153	114
GKSDB 90 300 FS	5486930	6480154	108
GKSDB 90 300 FS	5486930	6480154	114
GKSDB 90 300 FT	5507000	6483154	114
GKSDB 90 400 FS	5486947	6480155	108
GKSDB 90 400 FS	5486947	6480155	114
GKSDB 90 400 FT	5507031	6483155	114
GKSDB 90 500 FS	5486954	6480156	108
GKSDB 90 500 FS	5486954	6480156	114
GKSDB 90 500 FT	5507048	6483156	114
GKSDBV 90100F FS	5487937	6480311	111
GKSDBV 90100F FT	5508076	6483311	111
GKSDBV 90100S FS	5487432	6480231	111
GKSDBV 90100S FS	5487432	6480231	116
GKSDBV 90100S FT	5507598	6483231	111
GKSDBV 90100S FT	5507598	6483231	116
GKSDBV 90150F FS	5488057	6480332	116
GKSDBV 90150F FS	5487944	6480312	111
GKSDBV 90150F FT	5508199	6483332	116
GKSDBV 90150F FT	5508083	6483312	111
GKSDBV 90150S FS	5487449	6480232	111
GKSDBV 90150S FS	5487449	6480232	116
GKSDBV 90150S FT	5571742	6483232	111

Type	GTIN	Item no.	Page
GKSDBV 90150S FT	5571742	6483232	116
GKSDBV 90200F FS	5488064	6480333	116
GKSDBV 90200F FS	5487951	6480313	111
GKSDBV 90200F FT	5508205	6483333	116
GKSDBV 90200F FT	5508090	6483313	111
GKSDBV 90200S FS	5571131	6480233	111
GKSDBV 90200S FS	5571131	6480233	116
GKSDBV 90200S FT	5507604	6483233	111
GKSDBV 90200S FT	5507604	6483233	116
GKSDBV 90300F FS	5488071	6480334	116
GKSDBV 90300F FS	5571186	6480314	111
GKSDBV 90300F FT	5508243	6483334	116
GKSDBV 90300F FT	5508106	6483314	111
GKSDBV 90300S FS	5487456	6480234	111
GKSDBV 90300S FS	5487456	6480234	116
GKSDBV 90300S FT	5507611	6483234	111
GKSDBV 90300S FT	5507611	6483234	116
GKSDBV 90400F FS	5488088	6480335	116
GKSDBV 90400F FS	5487968	6480315	111
GKSDBV 90400F FT	5508250	6483335	116
GKSDBV 90400F FT	5508113	6483315	111
GKSDBV 90400S FS	5487463	6480235	111
GKSDBV 90400S FS	5487463	6480235	116
GKSDBV 90400S FT	5507628	6483235	111
GKSDBV 90400S FT	5507628	6483235	116
GKSDBV 90500F FS	5488095	6480336	116
GKSDBV 90500F FS	5487975	6480316	111
GKSDBV 90500F FT	5508267	6483336	116
GKSDBV 90500F FT	5508120	6483316	111
GKSDBV 90500S FS	5487470	6480236	111
GKSDBV 90500S FS	5487470	6480236	116
GKSDBV 90500S FT	5507635	6483236	111
GKSDBV 90500S FT	5507635	6483236	116
GKSDK 100 FS	5489306	6480531	110
GKSDK 100 FT	5509981	6483531	110
GKSDK 150 FS	5489313	6480532	118
GKSDK 150 FS	5489313	6480532	110
GKSDK 150 FT	5509998	6483532	118
GKSDK 150 FT	5509998	6483532	110
GKSDK 200 FS	5489320	6480533	118
GKSDK 200 FS	5489320	6480533	110
GKSDK 200 FT	5510000	6483533	118
GKSDK 200 FT	5510000	6483533	110
GKSDK 300 FS	5489337	6480534	118
GKSDK 300 FS	5489337	6480534	110
GKSDK 300 FT	5510048	6483534	118
GKSDK 300 FT	5510048	6483534	110
GKSDK 400 FS	5571292	6480535	118
GKSDK 400 FS	5571292	6480535	110
GKSDK 400 FT	5510055	6483535	118
GKSDK 400 FT	5510055	6483535	110
GKSDK 500 FS	5489344	6480536	118
GKSDK 500 FS	5489344	6480536	110
GKSDK 500 FT	5510062	6483536	118
GKSDK 500 FT	5510062	6483536	110
GKSDT 100 FS	5488941	6480491	109
GKSDT 100 FS	5488941	6480491	117
GKSDT 100 FT	5509516	6483491	109
GKSDT 100 FT	5509516	6483491	117
GKSDT 150 FS	5488958	6480492	109
GKSDT 150 FS	5488958	6480492	117
GKSDT 150 FT	5509523	6483492	109
GKSDT 150 FT	5509523	6483492	117
GKSDT 200 FS	5488965	6480493	109
GKSDT 200 FS	5488965	6480493	117
GKSDT 200 FT	5509561	6483493	109
GKSDT 200 FT	5509561	6483493	117
GKSDT 300 FS	5488972	6480494	109
GKSDT 300 FS	5488972	6480494	117
GKSDT 300 FT	5509578	6483494	109
GKSDT 300 FT	5509578	6483494	117
GKSDT 400 FS	5488989	6480495	109
GKSDT 400 FS	5488989	6480495	117
GKSDT 400 FT	5509585	6483495	109
GKSDT 400 FT	5509585	6483495	117
GKSDT 500 FS	5488996	6480496	109
GKSDT 500 FS	5488996	6480496	117
GKSDT 500 FT	5509622	6483496	109
GKSDT 500 FT	5509622	6483496	117
GKSGO 60 FS	5495147	6481352	106
GKSGV 60 FS	5495123	6481350	106
GKSK 115 FS	5489221	6480522	118
GKSK 115 FT	5509875	6483522	118

Type	GTIN	Item no.	Page
GKSK 120 FS	5489238	6480523	118
GKSK 120 FT	5509882	6483523	118
GKSK 130 FS	5489245	6480524	118
GKSK 130 FT	5509929	6483524	118
GKSK 140 FS	5489283	6480525	118
GKSK 140 FT	5509936	6483525	118
GKSK 150 FS	5489290	6480526	118
GKSK 150 FT	5509943	6483526	118
GKSK 610 FS	5489009	6480501	110
GKSK 610 FT	5509639	6483501	110
GKSK 615 FS	5489047	6480502	110
GKSK 615 FT	5509646	6483502	110
GKSK 620 FS	5489054	6480503	110
GKSK 620 FT	5509684	6483503	110
GKSK 630 FS	5489061	6480504	110
GKSK 630 FT	5509691	6483504	110
GKSK 640 FS	5489092	6480505	110
GKSK 640 FT	5509707	6483505	110
GKSK 650 FS	5489108	6480506	110
GKSK 650 FT	5509745	6483506	110
GKSLVL 100 FS	5495055	6481342	114
GKSLVL 100 FT	5516712	6484335	114
GKSLVL 60 FS	5495031	6481340	106
GKSLVL 60 FT	5516668	6484331	106
GKSRA 1 100 FS	5491811	6480864	118
GKSRA 1 125 FS	5491828	6480865	118
GKSRA 1 150 FS	5491866	6480866	118
GKSRA 1 175 FS	5491873	6480867	118
GKSRA 1 200 FS	5491880	6480868	118
GKSRA 1 25 FS	5491750	6480861	118
GKSRA 1 50 FS	5491767	6480862	118
GKSRA 1 75 FS	5491804	6480863	118
GKSRA 6 100 FS	5491590	6480844	107
GKSRA 6 125 FS	5491606	6480845	107
GKSRA 6 150 FS	5491613	6480846	107
GKSRA 6 175 FS	5491620	6480847	107
GKSRA 6 200 FS	5491637	6480848	107
GKSRA 6 25 FS	5491569	6480841	107
GKSRA 6 50 FS	5491576	6480842	107
GKSRA 6 75 FS	5491583	6480843	107
GKSRL 100 100 FS	5492191	6480899	119
GKSRL 100 150 FS	5492177	6480895	119
GKSRL 100 200 FS	5492207	6480901	119
GKSRL 100 250 FS	5492214	6480903	119
GKSRL 100 300 FS	5492221	6480905	119
GKSRL 100 350 FS	5492238	6480907	119
GKSRL 100 400 FS	5492245	6480909	119
GKSRL 100 50 FS	5492184	6480897	119
GKSRL 6 100 FS	5491903	6480872	106
GKSRL 6 150 FS	5491910	6480873	106
GKSRL 6 200 FS	5491927	6480874	106
GKSRL 6 250 FS	5491934	6480875	106
GKSRL 6 300 FS	5491941	6480876	106
GKSRL 6 350 FS	5491989	6480877	106
GKSRL 6 400 FS	5491996	6480878	106
GKSRL 6 50 FS	5491897	6480871	106
GKST 115 FS	5488897	6480482	117
GKST 115 FT	5509400	6483482	117
GKST 120 FS	5488903	6480483	117
GKST 120 FT	5509448	6483483	117
GKST 130 FS	5488910	6480484	117
GKST 130 FT	5509455	6483484	117
GKST 140 FS	5488927	6480485	117
GKST 140 FT	5509462	6483485	117
GKST 150 FS	5488934	6480486	117
GKST 150 FT	5509509	6483486	117
GKST 610 FS	5488781	6480461	110
GKST 610 FT	5571797	6483461	110
GKST 615 FS	5571261	6480462	110
GKST 615 FT	5509202	6483462	110
GKST 620 FS	5488798	6480463	110
GKST 620 FT	5509219	6483463	110
GKST 630 FS	5488804	6480464	110
GKST 630 FT	5509226	6483464	110
GKST 640 FS	5488811	6480465	110
GKST 640 FT	5509264	6483465	110
GKST 650 FS	5488828	6480466	110
GKST 650 FT	5509271	6483466	110
GKSTSG 100 FS	5486671	6480113	113
GKSTSG 60 FS	5486657	6480111	105

Type	GTIN	Item no.	Page
GKT 38 A2	6013579	/pc. 6017045	125
GKT 38 FT	6013630	6017061	125
GKT 38 G	6307937	6017037	125
GMS 2 VP FT	5486022	/100 pc. 1124645	63
GMS 2 VW 90 FT	5486091	1124659	63
GMS 3 VP FT	5486039	1124647	63
GMS 3 VW 90 FT	5486107	1124661	63
GMS 4 VP FT	5486046	1124649	63
GMS 4 VW 90 FT	5486114	1124663	64
GMS 6 KD A2	6559831	1124796	64
GMS 6 KD A4	6559848	1124798	64
GMS 6 KD FT	6559824	1124792	64
GR 105 100 A2	6344628	price/m 6002811	123
GR 105 100 FT	6002412	6003109	123
GR 105 100 G	6353958	6002838	123
GR 105 150 A2	6515448	6002815	123
GR 105 150 FT	6965304	6003168	123
GR 105 150 G	6624553	6002803	123
GR 105 200 A2	6344611	6002749	123
GR 105 200 FT	6002474	6003206	123
GR 105 200 G	6354016	6002846	123
GR 105 300 A2	6354139	6002862	123
GR 105 300 FT	6002535	6003303	123
GR 105 300 G	6354078	6002854	123
GR 105 400 A2	6354191	6002870	123
GR 105 400 FT	6002597	6003400	123
GR 105 400 G	6354252	6002927	123
GR 105 500 A2	6515455	6002874	123
GR 105 500 FT	6002658	6003508	123
GR 105 500 G	6354313	6002935	123
GR 105 600 A2	6515462	6002878	123
GR 105 600 FT	6002719	6003605	123
GR 105 600 G	7261559	6002943	123
GR 55 050 A2	6119776	6000904	122
GR 55 050 G	6759439	6004806	122
GR 55 100 A2	6000371	price/m 6000908	122
GR 55 100 FT	6000012	6000118	122
GR 55 100 G	6759491	6004814	122
GR 55 150 A2	6515493	6000912	122
GR 55 150 FT	6625819	6000150	122
GR 55 150 G	6759552	6004822	122
GR 55 200V A2	6000432	6000916	122
GR 55 200V FT	6965366	6005039	122
GR 55 200V G	6759613	6004830	122
GR 55 300 A2	6000494	6000924	122
GR 55 300 FT	6000135	6000304	122
GR 55 300 G	6759675	6004849	122
GR 55 400 A2	6000555	6000932	122
GR 55 400 FT	6000197	6000401	122
GR 55 400 G	6759736	6004857	122
GR 55 50 FT	6997992	6000117	122
GR 55 500 A2	6000616	price/m 6000940	122
GR 55 500 FT	6000258	6000509	122
GR 55 500 G	6759798	6004865	122
GR 55 600 A2	6000678	6000959	122
GR 55 600 FT	6000319	6000606	122
GR 55 600 G	6350896	6000770	122
GR KS 3.9 OR	5872887	/100 pc. 6003750	126
GR KS 4.8 OR	5872894	6003754	126
GRS 4.8 DD	6517992	/pc. 6016561	124
GRV 245 A4	6054312	6016688	124
GRV 245 DD	6054251	6016684	124
GRV 245 FS	6052578	6016680	124
GSV 34 A2	6013210	6016642	124
GSV 34 FT	6013159	6016634	124
GSV 34 G	6520510	6016596	124
GUV 6 A2	6593880	6016574	131
GUV 6 FT	6593873	6016573	131
GUV 6 G	6593866	6016572	131



Type	GTIN	Item no.	Page
HN M10 G	5298212	/100 pc. 3400107	69
HN M12 G	5298274	3400123	69
HN M8 G	5298151	3400085	69
K 12 1818 FS	6208876	/pc. 6437109	132
K 6 101 FS	6190393	6343090	133
K 6 101 FT	6190454	6343104	133
K12 1818 A2	6013036	6016421	132
KAB GR A2	5807155	6220145	125
KAB GR FS	5677932	6220139	125
KAB GR FT	5807124	6220142	125
KS GR LBL	5903468	6017714	126
KS GR LGR	5848264	6017710	126
KS GR OR	5848288	6017712	126
KS GR SGN	5903475	6017715	126
KS GR VKG	5848271	6017711	126
KS GR ZGB	5848295	6017713	126
KSB 2 PVC	6295395	price/100 6072909	71
KSB 2 PVC	6295395	6072909	97
KSB 4 PVC	6295579	6072895	97
KSB 4 PVC	6295579	6072895	71
KU 3 A2	5706014	/pc. 6348876	48
KU 3 FT	6340217	6348874	48
KU 5 V A2	5018360	6348925	52
KU 5 V FT	6901456	6348920	52
KU 7 NOX FT	6191352	6349056	54
KU 7 VQP FT	6191475	6349153	54
KUS 5 FT	6168910	6348904	51
KUS 5 NOK FT	6437771	6348939	52
LB 90 10100VS FS	6511983	6487292	143
LB 90 10100VS FT	6513048	6487272	143
LB 90 120 VS FS	6513055	6487282	143
LB 90 120 VS FT	6512973	6487262	143
LB 90 130 VS FS	6513062	6487284	143
LB 90 130 VS FT	6512980	6487264	143
LB 90 145 VS FS	6513093	6487286	143
LB 90 145 VS FT	6512997	6487266	143
LB 90 160 VS FS	6513109	6487288	143
LB 90 160 VS FT	6513000	6487268	143
LB 90 175 VS FS	6513116	6487290	143
LB 90 175 VS FT	6513031	6487270	143
LB 90 190 VS FS	6514847	6487291	143
LB 90 190 VS FT	6514830	6487271	143
LB 90 520 VS FS	6512737	6487212	136
LB 90 520 VS FT	6512676	6487202	136
LB 90 530 VS FS	6512744	6487214	136
LB 90 530 VS FT	6512683	6487204	136
LB 90 545 VS FS	6512751	6487216	136
LB 90 545 VS FT	6512690	6487206	136
LB 90 560 VS FS	6512768	6487218	136
LB 90 560 VS FT	6512706	6487208	136
LB 90 7100 VS FS	6512942	6487252	140
LB 90 7100 VS FT	6512867	6487232	140
LB 90 720 VS FS	6512874	6487242	140
LB 90 720 VS FT	6512799	6487222	140
LB 90 730 VS FS	6512881	6487244	140
LB 90 730 VS FT	6512805	6487224	140
LB 90 745 VS FS	6512911	6487246	140
LB 90 745 VS FT	6512812	6487226	140
LB 90 760 VS FS	6512928	6487248	140
LB 90 760 VS FT	6512829	6487228	140
LB 90 775 VS FS	6512935	6487250	140
LB 90 775 VS FT	6512850	6487230	140
LG 10100 VS FS	6512645	6487136	142
LG 10100 VS FT	6512553	6487116	142
LG 1020 VS FS	6512560	6487122	142
LG 1020 VS FT	6512454	6487102	142
LG 1030 VS FS	6512577	6487124	142
LG 1030 VS FT	6512461	6487104	142
LG 1045 VS FS	6512584	6487127	142

Type	GTIN	Item no.	Page
LG 1045 VS FT	6512492	6487107	142
LG 1060 VS FS	6512614	6487129	142
LG 1060 VS FT	6512508	6487109	142
LG 1075 VS FS	6512621	6487132	142
LG 1075 VS FT	6512515	6487112	142
LG 1090 VS FS	6512638	6487134	142
LG 1090 VS FT	6512522	6487114	142
LG 520 VS FS	6512218	6487012	136
LG 520 VS FT	6512157	6487002	136
LG 530 VS FS	6512225	6487014	136
LG 530 VS FT	6512164	6487004	136
LG 545 VS FS	6512256	6487017	136
LG 545 VS FT	6512195	6487007	136
LG 560 VS FS	6512263	6487019	136
LG 560 VS FT	6512201	6487009	136
LG 7100 VS FS	6512447	6487065	139
LG 7100 VS FT	6512348	6487045	139
LG 720 VS FS	6512379	6487052	139
LG 720 VS FT	6512270	6487032	139
LG 730 VS FS	6512386	6487054	139
LG 730 VS FT	6512287	6487034	139
LG 745 VS FS	6512393	6487057	139
LG 745 VS FT	6512317	6487037	139
LG 760 VS FS	6512409	6487059	139
LG 760 VS FT	6512324	6487039	139
LG 775 VS FS	6512430	6487062	139
LG 775 VS FT	6512331	6487042	139
LGVG 100 FS	6513215	6487319	142
LGVG 100 FT	6513161	6487309	142
LGVG 50 FS	6513178	6487315	136
LGVG 50 FT	6513123	6487305	136
LGVG 75 FS	6513185	6487317	139
LGVG 75 FT	6513154	6487307	139
LK 10100 VS FS	6514250	6487614	144
LK 10100 VS FT	6514144	6487594	144
LK 1020 VS FS	6514175	6487602	144
LK 1020 VS FT	6514069	6487582	144
LK 1030 VS FS	6514182	6487604	144
LK 1030 VS FT	6514076	6487584	144
LK 1045 VS FS	6514199	6487606	144
LK 1045 VS FT	6514083	6487586	144
LK 1060 VS FS	6514205	6487608	144
LK 1060 VS FT	6514113	6487588	144
LK 1075 VS FS	6514236	6487610	144
LK 1075 VS FT	6514120	6487590	144
LK 1090 VS FS	6514243	6487612	144
LK 1090 VS FT	6514137	6487592	144
LK 520 VS FS	6513833	6487512	138
LK 520 VS FT	6513772	6487502	138
LK 530 VS FS	6513840	6487514	138
LK 530 VS FT	6513789	6487504	138
LK 545 VS FS	6513871	6487516	138
LK 545 VS FT	6513819	6487506	138
LK 560 VS FS	6513888	6487518	138
LK 560 VS FT	6513826	6487508	138
LK 7100 VS FS	6514052	6487565	141
LK 7100 VS FT	6513963	6487544	141
LK 720 VS FS	6513994	6487552	141
LK 720 VS FT	6513895	6487532	141
LK 730 VS FS	6514007	6487554	141
LK 730 VS FT	6513901	6487534	141
LK 745 VS FS	6514014	6487557	141
LK 745 VS FT	6513932	6487536	141
LK 760 VS FS	6514021	6487558	141
LK 760 VS FT	6513949	6487538	141
LK 775 VS FS	6514045	6487560	141
LK 775 VS FT	6513956	6487540	141
LKS 40 FT	6164592	/pc. 6221084	145
LKS 60 4 FT	6164653	6221122	145
LMFV 120 FS	6513710	6487462	143
LMFV 120 FT	6513659	6487452	143
LMFV 130 FS	6513727	6487464	143
LMFV 130 FT	6513666	6487454	143
LMFV 145 FS	6513758	6487466	143
LMFV 145 FT	6513697	6487456	143
LMFV 160 FS	6513765	6487468	143



Type	GTIN	Item no.	Page
LMFV 160 FT	6513703	6487458	143
LMFV 520 FS	6513420	6487412	137
LMFV 520 FT	6513369	6487402	137
LMFV 530 FS	6513468	6487414	137
LMFV 530 FT	6513390	6487404	137
LMFV 545 FS	6513475	6487416	137
LMFV 545 FT	6513406	6487406	137
LMFV 560 FS	6513482	6487418	137
LMFV 560 FT	6513413	6487408	137
LMFV 720 FS	6513581	6487432	140
LMFV 720 FT	6513529	6487422	140
LMFV 730 FS	6513598	6487434	140
LMFV 730 FT	6513536	6487424	140
LMFV 745 FS	6513604	6487436	140
LMFV 745 FT	6513543	6487426	140
LMFV 760 FS	6513642	6487438	140
LMFV 760 FT	6513574	6487428	140
LT 10100 VS FS	6514809	6487754	143
LT 10100 VS FT	6514687	6487735	143
LT 1020 VS FS	6514717	6487743	143
LT 1020 VS FT	6514595	6487722	143
LT 1030 VS FS	6514724	6487744	143
LT 1030 VS FT	6514601	6487724	143
LT 1045 VS FS	6514731	6487746	143
LT 1045 VS FT	6514618	6487727	143
LT 1060 VS FS	6514748	6487748	143
LT 1060 VS FT	6514625	6487728	143
LT 1075 VS FS	6514786	6487751	143
LT 1075 VS FT	6514663	6487730	143
LT 1090 VS FS	6514793	6487752	143
LT 1090 VS FT	6514670	6487732	143
LT 520 VS FS	6514328	6487672	137
LT 520 VS FT	6514267	6487662	137
LT 530 VS FS	6514359	6487674	137
LT 530 VS FT	6514298	6487664	137
LT 545 VS FS	6514366	6487676	137
LT 545 VS FT	6514304	6487666	137
LT 560 VS FS	6514373	6487678	137
LT 560 VS FT	6514311	6487668	137
LT 7100 VS FS	6514564	6487712	140
LT 7100 VS FT	6514489	6487692	140
LT 720 VS FS	6514496	6487702	140
LT 720 VS FT	6514380	6487682	140
LT 730 VS FS	6514502	6487704	140
LT 730 VS FT	6514427	6487684	140
LT 745 VS FS	6514533	6487706	140
LT 745 VS FT	6514434	6487686	140
LT 760 VS FS	6514540	6487708	140
LT 760 VS FT	6514441	6487688	140
LT 775 VS FS	6514557	6487710	140
LT 775 VS FT	6514472	6487690	140
LVG 100 FS	6513291	6487339	142
LVG 100 FT	6513246	6487329	142
LVG 50 FS	6513277	6487335	137
LVG 50 FT	6513222	6487325	137
LVG 75 FS	6513284	6487337	139
LVG 75 FT	6513239	6487327	139
LWVG 100 FS	6513352	6487366	142
LWVG 100 FT	6513321	6487356	142
LWVG 50 FS	6513338	6487362	137
LWVG 50 FT	6513307	6487352	137
LWVG 75 FS	6513345	6487364	139
LWVG 75 FT	6513314	6487354	139
MP UNI A2	5166320	7085133	97
MP UNI A2	5166320	7085133	125
MP UNI FS	6146895	7084773	97
MP UNI FS	6146895	7084773	125
MPG 65 FT	6933259	6006486	132
MPG 90 FT	6933310	6006487	132
MS4121P2000FS	5686262	1122918	62
MS4121P2000FT	5697541	1122923	63
MS4121P3000FS	5686279	1122920	62
MS4121P3000FT	5686293	1122924	63
MS5030P2000FT	5049210	1121464	62

Type	GTIN	Item no.	Page
RAA 110 FS	6819799	7002637	93
RAA 110 FT	6813490	7123116	93
RAA 120 FS	6819850	7002653	93
RAA 120 FT	6813551	7123213	93
RAA 130 FS	6819911	7002688	93
RAA 130 FT	6813674	7123310	93
RAA 140 FS	6213610	7002696	93
RAA 140 FT	6247097	7123396	93
RAA 150 FS	6213672	7002726	93
RAA 150 FT	6247158	7123507	93
RAA 610 A2	6821235	7136120	81
RAA 610 FS	6379392	6040403	81
RAA 610 FT	6813131	7121109	81
RAA 615 FS	6502639	6040411	81
RAA 615 FT	6027002	7121205	81
RAA 620 A2	6821297	7136133	81
RAA 620 FS	6379453	6040438	81
RAA 620 FT	6813193	7121210	81
RAA 630 A2	6821358	7136141	81
RAA 630 FS	6379514	6040446	81
RAA 630 FT	6813254	7121318	81
RAA 640 A2	6256877	7136242	81
RAA 640 FS	6212897	7002394	81
RAA 640 FT	6246373	7121407	81
RAA 650 A2	6256938	7136250	81
RAA 650 FS	6212958	7002416	81
RAA 650 FT	6246434	7121504	81
RAA 660 A2	6256990	7136269	81
RAA 660 FS	6213016	7002432	81
RAA 660 FT	6246496	7121601	81
RAA 690 FT	6329687	7121609	81
RAA 810 FS	6819614	7002475	87
RAA 810 FT	6813315	7122109	87
RAA 820 FS	6819676	7002491	87
RAA 820 FT	6813377	7122213	87
RAA 830 FS	6819737	7002513	87
RAA 830 FT	6813438	7122310	87
RAA 840 FS	6213252	7002521	87
RAA 840 FT	6246731	7122403	87
RAA 850 FS	6213313	7002556	87
RAA 850 FT	6246793	7122500	87
RAA 860 FS	6213375	7002572	87
RAA 860 FT	6246854	7122608	87
RB 45 110 FS	6818594	7000634	92
RB 45 110 FT	6991280	7068115	92
RB 45 120 FS	6818778	7000650	92
RB 45 120 FT	6991341	7068212	92
RB 45 130 FS	6818839	7000677	92
RB 45 130 FT	6991402	7068328	92
RB 45 140 FS	6211098	7000685	92
RB 45 140 FT	6225552	7068409	92
RB 45 150 FS	6211159	7000707	92
RB 45 150 FT	6225613	7068506	92
RB 45 610 A2	6820696	7133107	79
RB 45 610 FS	6052271	6043763	79
RB 45 610 FT	6990924	7066112	79
RB 45 615 FS	6052219	6043755	79
RB 45 615 FT	6901579	7066158	79
RB 45 620 A2	6820757	7133120	79
RB 45 620 FS	6052332	6043771	79
RB 45 620 FT	6990986	7066228	79
RB 45 630 A2	6820818	7133142	79
RB 45 630 FS	6052394	6043798	79
RB 45 630 FT	6991044	7066317	79
RB 45 640 FS	6210374	7000383	80
RB 45 640 FT	6224838	7066406	80
RB 45 645 FT	6962488	7066457	80
RB 45 650 FS	6210435	7000405	80
RB 45 650 FT	6224890	7066503	80
RB 45 660 FS	6210497	7000421	80
RB 45 660 FT	6224951	7066600	80
RB 45 675 FT	6127863	7066720	80
RB 45 690 FT	6127979	7066729	80
RB 45 810 FS	6818419	7000472	86
RB 45 810 FT	6991105	7067119	86
RB 45 820 FS	6818471	7000499	86
RB 45 820 FT	6991167	7067216	86
RB 45 830 FS	6818532	7000510	86
RB 45 830 FT	6991228	7067313	86
RB 45 840 FS	6210732	7000529	86



Type	GTIN	Item no.	Page
RB 45 840 FT	6225194	7067402	86
RB 45 850 FS	6210794	7000545	86
RB 45 850 FT	6225255	7067496	86
RB 45 860 FS	6210855	7000561	86
RB 45 860 FT	6225316	7067607	86
RB 90 110 FS	6819430	7001894	92
RB 90 110 FT	6814695	7127103	92
RB 90 120 FS	6819492	7001916	92
RB 90 120 FT	6814756	7127227	92
RB 90 130 FS	6819553	7001932	92
RB 90 130 FT	6814817	7127320	92
RB 90 140 FS	6212354	7001940	93
RB 90 140 FT	6248414	7127413	93
RB 90 150 FS	6212415	7001967	93
RB 90 150 FT	6248476	7127499	93
RB 90 160 FT	6935475	7127627	93
RB 90 610 A2	6820870	7134122	80
RB 90 610 FS	6050475	6043216	80
RB 90 610 FT	6814091	7125100	80
RB 90 615 FS	6050413	6043208	80
RB 90 615 FT	6901753	7125189	80
RB 90 620 A2	6820931	7134130	80
RB 90 620 FS	6050536	6043224	80
RB 90 620 FT	6814152	7125220	80
RB 90 630 A2	6820993	7134138	80
RB 90 630 FS	6050598	6043232	80
RB 90 630 FT	6814336	7125305	80
RB 90 640 FS	6211630	7001290	80
RB 90 640 FT	6247691	7125410	80
RB 90 645 FT	6962907	7125461	80
RB 90 650 FS	6211692	7001304	80
RB 90 650 FT	6247752	7125526	80
RB 90 660 FS	6211753	7001312	80
RB 90 660 FT	6247813	7125585	80
RB 90 675 FT	5919964	7125586	80
RB 90 690 FT	5919971	7125588	80
RB 90 810 FS	6818891	7001762	86
RB 90 810 FT	6814510	7126127	86
RB 90 820 FS	6819317	7001789	86
RB 90 820 FT	6814572	7126216	86
RB 90 830 FS	6819379	7001800	86
RB 90 830 FT	6814633	7126301	86
RB 90 840 FS	6211999	7001819	87
RB 90 840 FT	6248056	7126417	87
RB 90 850 FS	6212057	7001835	87
RB 90 850 FT	6248117	7126514	87
RB 90 860 FS	6212118	7001851	87
RB 90 860 FT	6248179	7126611	87
RBU 45 640 A2	6253630	7133235	80
RBU 45 650 A2	6253692	7133243	80
RBU 45 660 A2	6253753	7133251	80
RBU 90 640 A2	6254712	7134231	80
RBU 90 650 A2	6254774	7134258	80
RBU 90 660 A2	6254835	7134266	80
RBV 110 F FS	5711810	7007350	95
RBV 110 F FT	5850922	7007468	95
RBV 110 S FS	5711711	7007310	95
RBV 110 S FT	5850908	7007398	95
RBV 120 F FS	5711827	7007354	95
RBV 120 F FT	5809210	7007470	95
RBV 120 S FS	5711728	7007314	95
RBV 120 S FT	5809197	7007400	95
RBV 130 F FS	5711834	7007358	95
RBV 130 F FT	5863649	7007359	95
RBV 130 S FS	5711759	7007318	95
RBV 130 S FT	5863618	7007319	95
RBV 140 F FS	5711841	7007362	95
RBV 140 F FT	5809227	7007474	95
RBV 140 S FS	5711766	7007322	95
RBV 140 S FT	5809203	7007404	95
RBV 150 F FS	5711872	7007366	95
RBV 150 F FT	5863687	7007367	95
RBV 150 S FS	5711773	7007326	95
RBV 150 S FT	5863625	7007327	95
RBV 160 F FS	5995623	7007373	95
RBV 160 F FT	5995647	7007374	95
RBV 160 S FS	5995586	7007333	95
RBV 160 S FT	5995609	7007334	95
RBV 610 F A2	5688563	7007155	83

Type	GTIN	Item no.	Page
RBV 610 F FS	5047445	7007055	83
RBV 610 F FT	5476818	7007056	83
RBV 610 S A2	5688556	7007105	83
RBV 610 S FS	5047322	7007005	83
RBV 610 S FT	5703730	7007006	83
RBV 615 F A2	5995654	7007156	83
RBV 615 F FS	5047452	7007059	83
RBV 615 F FT	5811022	7007060	83
RBV 615 S A2	5995678	7007107	83
RBV 615 S FS	5047339	7007009	83
RBV 615 S FT	5811015	7007010	83
RBV 620 F A2	5886112	7007157	83
RBV 620 F FS	5047469	7007063	83
RBV 620 F FT	5703785	7007064	83
RBV 620 S A2	5886181	7007109	83
RBV 620 S FS	5047346	7007013	83
RBV 620 S FT	5703747	7007014	83
RBV 630 F A2	5886129	7007159	83
RBV 630 F FS	5047490	7007067	83
RBV 630 F FT	5863298	7007068	83
RBV 630 S A2	5886198	7007113	83
RBV 630 S FS	5047377	7007017	83
RBV 630 S FT	5863342	7007018	83
RBV 640 F A2	5886136	7007161	83
RBV 640 F FS	5047506	7007071	83
RBV 640 F FT	5863304	7007072	83
RBV 640 S A2	5886204	7007117	83
RBV 640 S FS	5047384	7007021	83
RBV 640 S FT	5863380	7007022	83
RBV 645 F FT	6134557	7007074	83
RBV 645 S FT	6134519	7007024	83
RBV 650 F A2	5886143	7007163	83
RBV 650 F FS	5047513	7007075	83
RBV 650 F FT	5863311	7007076	83
RBV 650 S A2	5886235	7007119	83
RBV 650 S FS	5047391	7007025	83
RBV 650 S FT	5863397	7007026	83
RBV 660 F A2	5886174	7007165	83
RBV 660 F FS	5047520	7007079	83
RBV 660 F FT	5863328	7007080	83
RBV 660 S A2	5886242	7007121	83
RBV 660 S FS	5047407	7007029	83
RBV 660 S FT	5863403	7007030	83
RBV 675 F FT	6134564	7007085	83
RBV 675 S FT	6134526	7007035	83
RBV 690 F FT	6132454	7007086	83
RBV 690 S FT	6132423	7007036	83
RBV 810 F FS	5711636	7007270	88
RBV 810 F FT	5863410	7007271	88
RBV 810 S FS	5711537	7007230	88
RBV 810 S FT	5863502	7007231	88
RBV 820 F FS	5711643	7007274	88
RBV 820 F FT	5863427	7007275	88
RBV 820 S FS	5711544	7007234	88
RBV 820 S FT	5863519	7007235	88
RBV 830 F FS	5711650	7007278	88
RBV 830 F FT	5863434	7007279	88
RBV 830 S FS	5711575	7007238	88
RBV 830 S FT	5863526	7007239	88
RBV 840 F FS	5711667	7007282	88
RBV 840 F FT	5863441	7007283	88
RBV 840 S FS	5711582	7007242	88
RBV 840 S FT	5863564	7007243	88
RBV 850 F FS	5711698	7007286	88
RBV 850 F FT	5863458	7007287	88
RBV 850 S FS	5711599	7007246	88
RBV 850 S FT	5863571	7007247	88
RBV 860 F FS	5711704	7007290	88
RBV 860 F FT	5863465	7007291	88
RBV 860 S FS	5711605	7007250	88
RBV 860 S FT	5863588	7007251	88
REV 110 FS	6066438	6067999	91
REV 60 A2	6066490	6068022	79
REV 60 FS	6066315	6067972	79
REV 85 FS	6066377	6067980	85
RGBV 110 FT	6230112	7081103	96
RGBV 120 FT	6230174	7081200	96
RGBV 130 FT	6230235	7081308	96
RGBV 140 FT	6230297	7081405	96
RGBV 150 FT	6230358	7081502	96



Type	GTIN	Item no.	Page
RGBV 160 FT	5995883	7081555 /pc.	96
RGV 110 A2	6986361	7082479	91
RGV 110 FS	6230655	7082037	91
RGV 110 FT	6230952	7082436	91
RGV 60 A2	6230839	7082258	78
RGV 60 FS	6230532	7082010	78
RGV 60 FT	6230778	7082223	78
RGV 85 FS	6230594	7082029	85
RGV 85 FT	6230891	7082320	85
RK 110 FS	6820511	7004648	94
RK 110 FT	6990085	7115113	94
RK 120 FS	6820573	7004664	94
RK 120 FT	6811878	7115210	94
RK 130 FS	6820634	7004680	94
RK 130 FT	6811939	7115318	94
RK 140 FS	6216130	7004699	95
RK 140 FT	6244454	7115407	95
RK 150 FS	6216192	7004710	95
RK 150 FT	6244515	7115504	95
RK 160 FT	6935239	7115564	95
RK 610 FS	6051670	6043615	82
RK 610 FT	6991709	7113110	82
RK 615 FS	6051618	6043607	82
RK 620 FS	6051731	6043623	82
RK 620 FT	6991761	7113218	82
RK 630 FS	6051793	6043631	82
RK 630 FT	6991822	7113315	82
RK 640 FS	6215416	7004397	82
RK 640 FT	6243730	7113404	82
RK 650 FS	6215478	7004419	82
RK 650 FT	6243792	7113501	82
RK 660 FS	6215539	7004435	82
RK 660 FT	6243853	7113609	82
RK 675 FT	5919988	7113611	82
RK 690 FT	5920021	7113613	82
RLVK 60 A2	6066018	6067654 /pc.	78
RLVK 60 FS	6065417	6067093	78
RLVK 60 FT	6065899	6067603	78
RLVL 110 A2	6400690	6067948	91
RLVL 110 FS	6065653	6067131	91
RLVL 110 FT	6066193	6067913	91
RLVL 85 FS	6065592	6067123	85
RLVL 85 FT	6066131	6067816	85
RT 110 FS	6820153	7003633	94
RT 110 FT	6812714	7119119	94
RT 120 FS	6820214	7003668	94
RT 120 FT	6812776	7119216	94
RT 130 FS	6820276	7003684	94
RT 130 FT	6812837	7119313	94
RT 140 FS	6214877	7003692	94
RT 140 FT	6245772	7119402	94
RT 150 FS	6214938	7003714	94
RT 150 FT	6245833	7119496	94
RT 610 FS	6051076	6043410	81
RT 610 FT	6812356	7117116	81
RT 615 FS	6051014	6043402	81
RT 615 FT	6901692	7117162	81
RT 620 FS	6051137	6043429	81
RT 620 FT	6812417	7117209	81
RT 630 FS	6051199	6043437	81
RT 630 FT	6812479	7117306	81
RT 640 FS	6214150	7003390	82
RT 640 FT	6245055	7117396	82
RT 645 FT	6962785	7117477	82
RT 650 FS	6214211	7003412 /pc.	82
RT 650 FT	6245116	7117507	82
RT 660 FS	6214273	7003439	82
RT 660 FT	6245178	7117604	82
RT 675 FT	5920038	7117606	82
RT 690 FT	5920045	7117608	82
RWEB 110 FS	6242771	7111096 /pc.	91
RWEB 120 FS	6242894	7111207	91
RWEB 130 FS	6243013	7111304	91

Type	GTIN	Item no.	Page
RWEB 140 FS	6243136	7111428 /pc.	91
RWEB 150 FS	6243198	7111509	91
RWEB 160 FS	5995517	7111740	91
RWEB 610 A2	6242054	7109814	79
RWEB 610 FS	6241637	7109105	79
RWEB 615 A2	5981084	7109816	79
RWEB 615 FS	6241699	7109156	79
RWEB 620 A2	6242115	7109830	79
RWEB 620 FS	6241750	7109202	79
RWEB 630 A2	6242177	7109857	79
RWEB 630 FS	6241811	7109296	79
RWEB 640 A2	6242238	7109873	79
RWEB 640 FS	6241873	7109407	79
RWEB 650 A2	6242290	7109903	79
RWEB 650 FS	6241934	7109504	79
RWEB 660 A2	6242351	7109938	79
RWEB 660 FS	6241996	7109601	79
RWEB 810 FS	6242412	7110103	85
RWEB 820 FS	6242474	7110200	85
RWEB 830 FS	6242535	7110308	85
RWEB 840 FS	6242597	7110405	85
RWEB 850 FS	6242658	7110502	85
RWEB 860 FS	6242719	7110618	85
RWVL 60 A2	6066070	6067662	78
RWVL 60 FS	6065530	6067115	78
RWVL 60 FT	6065950	6067611	78
		price/m	
SGR 105 150 FT	6397716	6003175	130
SGR 105 200 FT	5670742	6003214	130
SGR 105 200 G	6397914	6002612	129
SGR 105 300 FT	6397723	6003309	130
SGR 105 300 G	6397921	6002614	129
SGR 105 400 FT	5651765	6003402	130
SGR 105 400 G	6397938	6002616	129
SGR 105 500 FT	6397730	6003515	130
SGR 105 500 G	6397945	6002620	129
SGR 105 600 FT	6397747	6003616	130
SGR 105 600 G	6397952	6002622	129
SGR 55 100 FT	6397655	6000122	128
SGR 55 100 G	6397778	6005470	128
SGR 55 150 FT	6397662	6000190	128
SGR 55 150 G	6397785	6005472	128
SGR 55 200 FT	5651758	6000209	128
SGR 55 200 G	6397792	6005474	128
SGR 55 300 FT	6397679	6000331	128
SGR 55 300 G	6397808	6005476	128
SGR 55 400 FT	6397686	6000451	128
SGR 55 400 G	6397846	6005478	128
SGR 55 500 FT	6397693	6000515	128
SGR 55 500 G	6397860	6005480	128
SGR 55 600 FT	6397709	6000775	128
SGR 55 600 G	6397853	6005482	128
SGR KS OR	5872900	6003758 /100 pc.	130
SH M10 A4	6952038	6015340 /pc.	132
SH M10 FS	6608539	6015336	132
SH M10 FT	6951970	6015338	132
SKS 10x120 F	5505631	3160793 /100 pc.	52
SKS 10x120 F	5505631	3160793	68
SKS 10x30 F	5257295	3160742	68
SKS 10x80 A4	6822133	6418248	47
SKS 10x80 F	6437474	6418250	47
SKS 10x80 F	6437474	6418250	52
SKS 10x80 F	6437474	6418250	68
SKS 110 FT	6062539	6061605 price/m	89
SKS 110 NC FS	6979431	6061110 price/m	89
SKS 120 FT	6062591	6061621 price/m	89
SKS 120 NC FS	6979509	6061207 price/m	89
SKS 12x110 F	6204557	6418317 /100 pc.	55
SKS 12x110 F	6204557	6418317	69
SKS 12x80 F	6204434	6418287	55
SKS 12x80 F	6204434	6418287	69
SKS 130 FT	6062652	6061656 price/m	89
SKS 130 NC FS	6979578	6061304 price/m	89



Type	GTIN	Item no.	Page
SKS 140 FT	6062713	price/m 6061672	89
SKS 140 NC FS	6979615	6061401	89
SKS 150 FT	6062775	price/m 6061702	89
SKS 150 NC FS	6979660	6061509	89
SKS 610 A2	6120550	price/m 6056735	75
SKS 610 FT	6389957	6056636	74
SKS 610 NC FS	6978618	6056106	74
SKS 615 FT	6390014	price/m 6056644	74
SKS 615 NC FS	6978663	6056157	74
SKS 620 A2	6120611	price/m 6056737	75
SKS 620 FT	6390076	6056652	74
SKS 620 NC FS	6978762	6056203	74
SKS 630 A2	6120673	price/m 6056739	75
SKS 630 FT	6390137	6056679	74
SKS 630 NC FS	6978793	6056297	74
SKS 640 A2	6120734	price/m 6056742	75
SKS 640 FT	6060559	6056695	74
SKS 640 NC FS	6978847	6056408	74
SKS 650 A2	6120796	price/m 6056744	75
SKS 650 FT	6060610	6056717	74
SKS 650 NC FS	6978885	6056505	74
SKS 660 A2	6120857	price/m 6056746	75
SKS 660 FT	6060672	6056733	74
SKS 660 NC FS	6978946	6056602	74
SKS 6x20 F	5255970	/100 pc. 3156516	68
SKS 810 FT	6061457	price/m 6058620	84
SKS 810 NC FS	6978984	6058109	84
SKS 820 FT	6061518	price/m 6058647	84
SKS 820 NC FS	6979028	6058206	84
SKS 830 FT	6061570	price/m 6058663	84
SKS 830 NC FS	6979097	6058303	84
SKS 840 FT	6061631	price/m 6058698	84
SKS 840 NC FS	6979196	6058397	84
SKS 850 FT	6061693	price/m 6058728	84
SKS 850 NC FS	6979264	6058508	84
SKS 860 FT	6061754	price/m 6058744	84
SKS 860 NC FS	6979332	6058605	84
SKS 8x20 F	5256632	/100 pc. 3158632	68
SKS 8x30 F	5256694	3158640	68
SKSU 110 FS	6395231	price/m 6063403	90
SKSU 120 FS	6395293	6063438	90
SKSU 130 FS	6395354	6063454	90
SKSU 140 FS	6395415	6063470	90
SKSU 150 FS	6395477	6063497	90
SKSU 610 FS	5060369	6063234	77
SKSU 620 FS	5060390	6063236	77
SKSU 630 FS	5060406	6063238	77
SKSU 640 FS	5060413	6063950	77
SKSU 650 FS	6063857	6063241	77
SKSU 660 FS	6063918	6063276	77
SSLB 100 A2	6095728	/pc. 7070353	96
SSLB 100 FS	6079971	7070205	96
SSLB 150 FS	6094820	7070209	96
SSLB 200 A2	6095780	7070361	96
SSLB 200 FS	6094882	7070213	96
SSLB 300 A2	6095841	7070365	96
SSLB 300 FS	6094943	7070217	96
SSLB 400 A2	6095902	7070369	96
SSLB 400 FS	6095001	7070221	96
SSLB 500 A2	6095964	7070373	96
SSLB 500 FS	6095063	7070225	96
SSLB 600 A2	6096022	7070381	96
SSLB 600 FS	6095186	7070233	96

Type	GTIN	Item no.	Page
SWS M10 G	5301752	/100 pc. 3404102	69
SWS M12 G	5301813	3404129	69
SWS M8 G	5301691	3404080	69
TKH-L-25 FT	6579259	price/pair 6355812	61
TKH-S-30 ZL	6677702	6355805	61
TKS-L-25 FT	6579075	price/pair 6355808	61
TKS-S-30 ZL	6677696	6355798	61
TPSG 3000 FS	6079032	/pc. 6366090	132
TR M10 1M G	5253396	/100 pc. 3141209	44
TR M10 1M G	5253396	3141209	132
TR M12 1M G	5253457	3141306	44
TR M12 1M G	5253457	3141306	132
TR M8 1M G	5253334	3141128	44
TR M8 1M G	5253334	3141128	132
TSG 110 FS	5694588	price/m 6062122	90
TSG 45 A2	5694441	6062025	77
TSG 45 FS	5694489	6062033	77
TSG 60 A2	5694557	6062084	78
TSG 60 FS	5694540	6062068	78
TSG 85 FS	5694571	6062114	84
TSGV A2	5694724	/pc. 6067970	78
TSGV A2	5694724	6067970	85
TSGV A2	5694724	6067970	91
US 3 100 A2	5705727	6342460	46
US 3 100 FS	6223572	6342318	46
US 3 150 A2	5705765	6342463	46
US 3 150 FS	6223633	6342328	46
US 3 20 FS	6221776	6342302	46
US 3 200 A2	5705772	6342466	46
US 3 200 FS	6224296	6342338	46
US 3 30 A2	5705703	6342455	46
US 3 30 FS	6222018	6342304	46
US 3 300 FS	5710905	6342340	46
US 3 40 FS	6222070	6342306	46
US 3 50 A2	5705710	6342457	46
US 3 50 FS	6222315	6342308	46
US 3 60 FS	6222377	6342310	46
US 3 70 FS	6222438	6342312	46
US 3 80 FS	6222490	6342314	46
US 3 90 FS	6223510	6342316	46
US 3 K 100 A2	5705437	6342417	46
US 3 K 100 FT	6225132	6342368	45
US 3 K 110 FT	6225378	6342370	45
US 3 K 120 FT	6225439	6342372	45
US 3 K 20 A2	5705352	6342401	46
US 3 K 20 FT	6224470	6342351	45
US 3 K 30 A2	5705369	6342403	46
US 3 K 30 FT	6224531	6342353	45
US 3 K 40 A2	5705376	6342405	46
US 3 K 40 FT	6224593	6342355	45
US 3 K 50 A2	5705383	6342407	46
US 3 K 50 FT	6224654	6342357	45
US 3 K 60 A2	5705390	6342409	46
US 3 K 60 FT	6224715	6342359	45
US 3 K 70 A2	5705406	6342411	46
US 3 K 70 FT	6224777	6342362	45
US 3 K 80 A2	5705413	6342413	46
US 3 K 80 FT	6225019	6342364	45
US 3 K 90 A2	5705420	6342415	46
US 3 K 90 FT	6225071	6342366	45
US 3 KS OR	5668039	6338458	47
US 5 100 A2	6082094	6341133	51
US 5 100 FT	6284177	6340962	51
US 5 110 A2	6082155	6341137	51
US 5 120 A2	6082216	6341141	51
US 5 150 FT	6437597	6340966	51
US 5 20 FT	6959006	6340881	51
US 5 200 FT	6437658	6340970	51
US 5 30 A2	6081615	6341105	51
US 5 30 FT	6959068	6340903	51

KTS_Typ_OA / en / 2021/07/05 08:46:01 (LLEXP02456) / 2021/07/05 08:46:17 08:46:17



Type	GTIN	Item no.	Page
US 5 300 A2	6082278	6341152	51
US 5 300 FT	6446957	6340989	51
US 5 40 A2	6081677	6341109	51
US 5 40 FT	6959129	6340911	51
US 5 50 A2	6081738	6341113	51
US 5 50 FT	6959181	6340938	51
US 5 60 A2	6081790	6341117	51
US 5 60 FT	6601752	6340946	51
US 5 70 A2	6081851	6341121	51
US 5 70 FT	6043927	6340950	51
US 5 80 A2	6081912	6341125	51
US 5 80 FT	6044047	6340954	51
US 5 90 A2	6081974	6341129	51
US 5 90 FT	6044160	6340958	51
US 5 K 100 A2	6350711	6341390	50
US 5 K 100 FT	6536290	6341616	49
US 5 K 110 A2	6350773	6341394	50
US 5 K 110 FT	6536238	6341624	49
US 5 K 120 A2	6350834	6341398	50
US 5 K 120 FT	6536177	6341632	49
US 5 K 20 A2	6477135	6341358	50
US 5 K 20 FT	6536771	6341527	49
US 5 K 30 A2	6644230	6341362	50
US 5 K 30 FT	6536719	6341535	49
US 5 K 40 A2	6350292	6341366	50
US 5 K 40 FT	6536658	6341543	49
US 5 K 50 A2	6350414	6341370	50
US 5 K 50 FT	6536597	6341551	49
US 5 K 60 A2	6350476	6341374	50
US 5 K 60 FT	6536535	6341578	49
US 5 K 70 A2	6350537	6341378	50
US 5 K 70 FT	6536474	6341586	49
US 5 K 80 A2	6350599	6341382	50
US 5 K 80 FT	6536412	6341594	49
US 5 K 90 A2	6624492	6341386	50
US 5 K 90 FT	6536351	6341608	49
US 5 KS OR	5668046	6338462	50
US 7 100 FT	6188178	6340180	54
US 7 110 FT	6188239	6340199	54
US 7 120 FT	6188291	6340202	54
US 7 130 FT	6188352	6340210	54
US 7 140 FT	6188413	6340229	54
US 7 150 FT	6188475	6340237	54
US 7 160 FT	6188536	6340245	54
US 7 170 FT	6188598	6340253	54
US 7 180 FT	6188659	6340261	54
US 7 190 FT	6188710	6340288	54
US 7 20 FT	6187690	6340016	54
US 7 200 FT	6188772	6340296	54
US 7 30 FT	6187751	6340032	54
US 7 300 FT	6188895	6340377	54
US 7 40 FT	6187812	6340059	54
US 7 50 FT	6187874	6340075	54
US 7 60 FT	6187935	6340091	54
US 7 70 FT	6187997	6340113	54
US 7 80 FT	6188055	6340148	54
US 7 90 FT	6188116	6340164	54
US 7 K 100 FT	6187034	6339182	53
US 7 K 110 FT	6187096	6339190	53
US 7 K 120 FT	6187157	6339204	53
US 7 K 130 FT	6187218	6339212	53
US 7 K 140 FT	6187270	6339220	53
US 7 K 150 FT	6187331	6339239	53
US 7 K 160 FT	6187393	6339247	53
US 7 K 170 FT	6187454	6339255	53
US 7 K 180 FT	6187515	6339263	53
US 7 K 190 FT	6187577	6339271	53
US 7 K 20 FT	6186556	6339018	53
US 7 K 200 FT	6187638	6339298	53
US 7 K 250 FT	6931217	6339334	53
US 7 K 30 FT	6186617	6339034	53
US 7 K 300 FT	6457458	6339360	53
US 7 K 40 FT	6186679	6339050	53
US 7 K 50 FT	6186730	6339077	53
US 7 K 60 FT	6186792	6339093	53
US 7 K 70 FT	6186853	6339115	53
US 7 K 80 FT	6186914	6339131	53
US 7 K 90 FT	6186976	6339166	53
US 7 KS OR	5668060	6338497	53
VUS 3 A2	5706007	6018517	47
VUS 3 FT	6229154	6018513	47
VUS 5 FT	6446896	6018505	51

Type	GTIN	Item no.	Page
VUS 7 FT	6014293	6018378	54
WB GR A4	6561261	6017164	127
WB GR FT	6561254	6017160	127
WS M10 D20 G	5300137	3402096	69
WS M12 D24 G	5300199	3402126	69
WS M8 D16 G	5300076	3402088	69

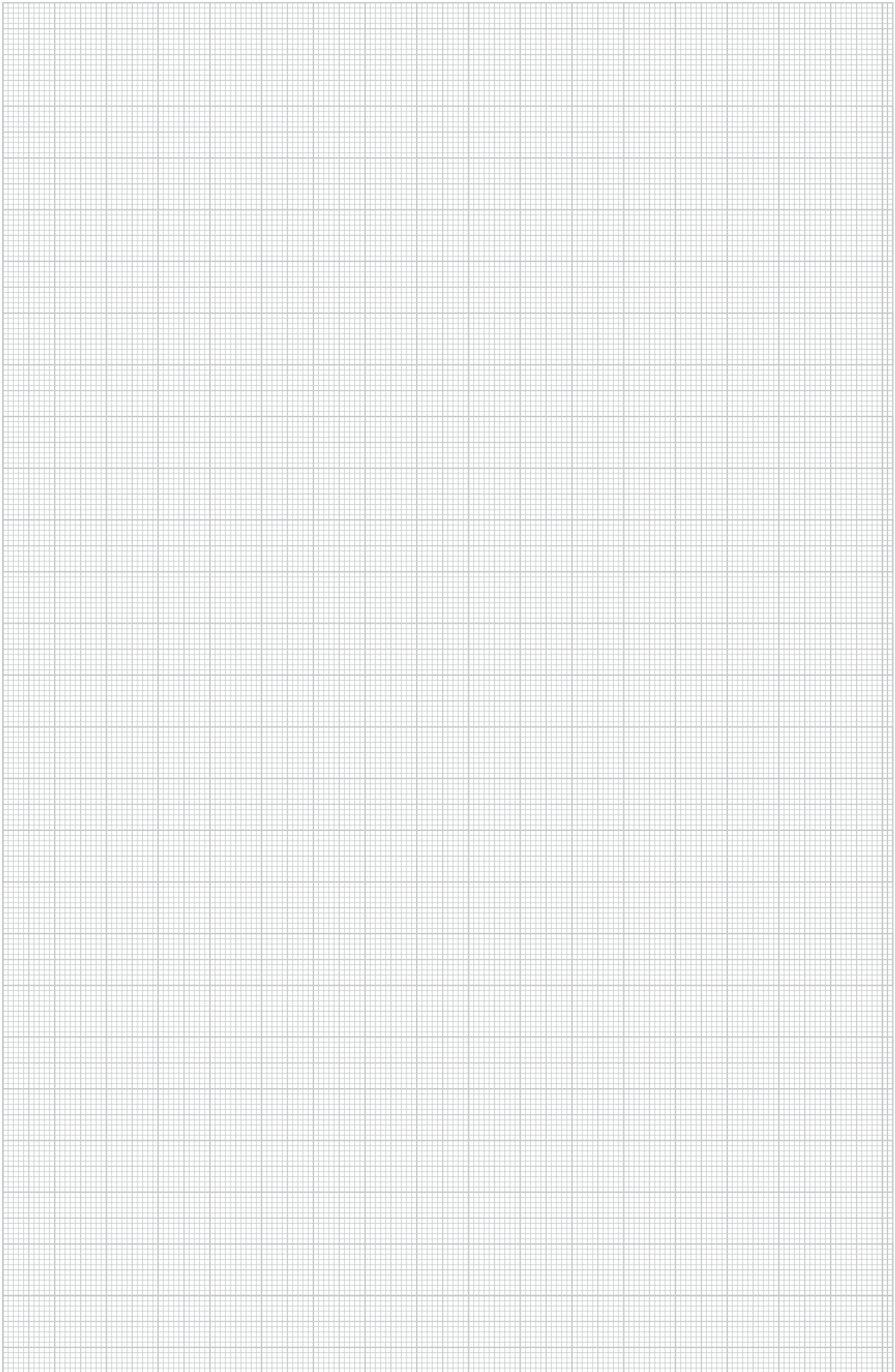

Sales Offices:

NORTH

OBO Bettermann India Pvt Ltd.
212, Ansal Chamber-II,
9, Bhikaji Cama Place,
New Delhi – 110066

Phone: +91 (0)11 4172 7344

EAST

OBO Bettermann India Pvt Ltd.
BJ-249, Sector – II, Salt Lake
Kolkata – 700091

Mobile: +91 (0)89 3999 3172

WEST 1

OBO Bettermann India Pvt Ltd.
Excellencia Lodha Supremus
Unit No. : 10, 1 Floor, Road No 22
Wagle Estate
Thane (W) – 400604

Mobile: +91 (0)88 7963 7276

WEST 2

Pune

Phone: +91 (0)78 2407 7761

SOUTH 2

OBO Bettermann India Pvt Ltd.
No. 32, 1 Cross, 17 Main Road,
BTM Layout, 1 Stage
Bengaluru – 560069

Phone: +91 (0)80 4206 2651

SOUTH 1

OBO Bettermann India Pvt Ltd.
Plot No. A - 51, SIPCOT industrial
Growth Centre,
Oragadam, Sriperumbudur Taluk,
Kancheepuram District – 602 105,
Tamil Nadu, India

Direct Phone: +91 (0)44 7103
3900

Territory locations:

Bhubaneswar
9042624814

Coimbatore
9962537190

Ernakulam
8879637273

Gujarat
9638432920

Guwahati
9836400525

Hyderabad
8939993192

Nagpur
78240 77762

Indore
8939993193

Jamshedpur
8102602220

Pune
8879637627

Visakhapatnam
9966008211

Patna
9708354536

Puducherry
9962537183

Raipur
9384018643

Thiruvananthapuram
8939993130