

Guide:
Earthing systems
Date: 02/2016



THINK CONNECTED.

Table of contents

Chapter 1.	Basic principles	3
Chapter 2.	Normative requirements	3
Chapter 3.	Earthing systems and their materials	4
Chapter 3.1	Individual foundations	4
Chapter 3.2	Foundation earth electrode	4
Chapter 3.3	Insulated earthing systems	6
Chapter 3.3.1	Perimeter insulation	7
Chapter 3.3.2	Black tank	8
Chapter 3.3.3	White tank	9
Chapter 3.4	Lightning protection earthing	11
Chapter 3.4.1	Ring earth electrode	11
Chapter 3.4.2	Earth rods	12
Chapter 3.5	Potential control against step voltages	14
Chapter 3.6	Touch voltage	16
Chapter 3.7	Labelling the connection lugs	17
Chapter 3.8	Earthing systems for wind power plants	17
Chapter 4.	Documentation	20
Chapter 5.	Selection aid	21
Chapter 6.	Conclusion	22
Chapter 7.	Literature notes	23

This guide is based on the currently known and valid rules and regulations and on our experience. The contents are not legally binding and make no claim to completeness.

Chapter 1. Basic principles

The earthing system is the basis for the safe function of every electrical system and its protection devices. It ensures operation and protects people against hazardous currents. Buildings with IT systems and data cabling have high requirements for electromagnetic compatibility measures (EMC).

To ensure the EMC shield and personal protection, a meshed equipotential bonding and a low-ohmic earthing system integrated in the structure are required.

Chapter 2. Normative requirements

The earthing system creates the electrical connection to the surrounding earth. The earthing resistance of the system should be as small as possible (less than 10 Ω) and must be coordinated with further protective measures and switch-off conditions.

The equipotential bonding based on the earthing system fulfils the following functions:

- Protection against electric shock – VDE 0100-410 (IEC 60364-4-41)
- Protective equipotential bonding – VDE 0100-540 (IEC 60364-5-54)
- Lightning protection equipotential bonding – VDE 0185-305 (IEC 62305)
- Energy systems and surge protection – VDE 0100-443 (IEC 60364-4-44)
- Low-voltage electrical installations – VDE 0100-444 (IEC 60364-5-54)
- Data cabling and shielding – VDE 0800-2-310 (EN 50310)
- Electromagnetic compatibility – EMC directive 2004/108/EC (EMVG)
- Antenna earthing – VDE 0855 (IEC 60728)
- Application of equipotential bonding and earthing in buildings with information technology equipment – VDE 0800-2-310 (EN 50310)
- Electrical installations in residential buildings – DIN 18015-1
- Foundation earth electrode – DIN 18014

In Germany, the foundation earth electrode in new buildings must meet the requirements of DIN 18014 and the technical connection conditions (TAB) of the power supply generator (VNB).

Note

Section 542.1.1 of VDE 0100-540 (IEC 60364-5-54):

"For protection and function purposes, earthing systems may be used together or separately, according to the requirements of the electrical system. The protection requirements must always have priority."

The earthing system thus represents a safety-relevant part and installation is only permitted if performed by an electrical or lightning protection specialist. In addition, the responsible specialist must be stated in the prescribed documentation.

The following infringements of the rules of technology are specified in § 319 "Causing danger during construction work" of the German Criminal Code:

1. Whosoever in the planning, management or execution of the construction or the demolition of a structure violates generally accepted engineering standards, and thereby endangers the life or limb of another person, shall be liable to imprisonment not exceeding five years or a fine.
2. Whosoever in engaging in a profession or trade violates generally accepted engineering standards in the planning, management or execution of a project to install technical fixtures in a structure or to modify installed fixtures of this nature, and thereby endangers the life or limb of another person, shall incur the same penalty.

3. Whosoever causes the danger negligently, shall be liable to imprisonment not exceeding three years or a fine.
4. Whosoever in cases under subsections (1) and (2) above acts negligently and causes the danger negligently shall be liable to imprisonment not exceeding two years or a fine.

The earthing system is a part of the electrical system. Only electrical or lightning protection specialists may install, check and accept the earthing system. Construction companies must allow the supervision of the installation and acceptance of the earthing system by electrical and lightning protection specialists.

Chapter 3. Earthing systems and their materials

Chapter 3.1 Individual foundations

Individual foundations, e.g. for supports, must have a foundation earth electrode with a length of at least 2.5 m. These foundations should be conductively connected and the maximum loop width of 20 x 20 m may not be exceeded. The corrosion resistance of the individual foundations and the conductors must be ensured using suitable measures and materials.

Chapter 3.2 Foundation earth electrode

A foundation earth electrode is a closed ring, ideally consisting of flat conductors or, alternatively, of round conductors, with a maximum loop width of 20 x 20 m. The foundation earth electrode is connected to the reinforcement at a spacing of approx. 2 m using clamp connectors. To ensure corrosion protection, the foundation earth electrode must be embedded in the concrete with a coating of at least 5 cm. The concrete sets up the electrical connection between the foundation earth electrode and the earth.

Note *According to the foundation earth electrode standard DIN 18014, wedge connectors are not approved for use in mechanically compacted concrete. Screwed-on connectors, for example, are considered secure connections.*

If the concrete is insulated, then there need be no electrical connection to the earth. The insulation means that the concrete dries out to a great extent. This is, for example, the case with versions as a black tank, with perimeter insulation or as a white tank. To achieve constant earthing resistance, the ring earth electrode must be attached in contact with the earth in moist, frost-free earth outside the foundation. This should be taken into account particularly in the case of large roof overhangs.

In this case, a ring earth electrode must additionally be used outside or beneath the concrete foundation. This ring earth electrode in contact with the earth is connected to the functional equipotential bonding conductor of the foundation (see chapter 4.3).

Note *Systems with high electromagnetic compatibility (EMC) requirements require a powerful foundation earth electrode. In this case, to reduce the impedance, the loop width may not be 20 x 20 m, but usually only 5 x 5 m (VDE 0185-305-4 / IEC 62305-4).*

The foundation earth electrode can also be used as a lightning protection earth electrode. To allow the connection of the lightning protection system, the connection lugs required for the down-conductors must protrude from the foundation. The materials must correspond to the lightning protection standard VDE 0185-305-3 Table 7 (IEC 62305-3) or the lightning protection components standard VDE 0185-561-2 (IEC 62561-2) (see Table 2).

Note

Floor plates made of steel fibre concrete do not fulfil the corrosion protection requirements with a 5 cm concrete coating. Before concreting, a ring earth electrode of stainless steel quality V4A (1.4404/1.4571) must be created.

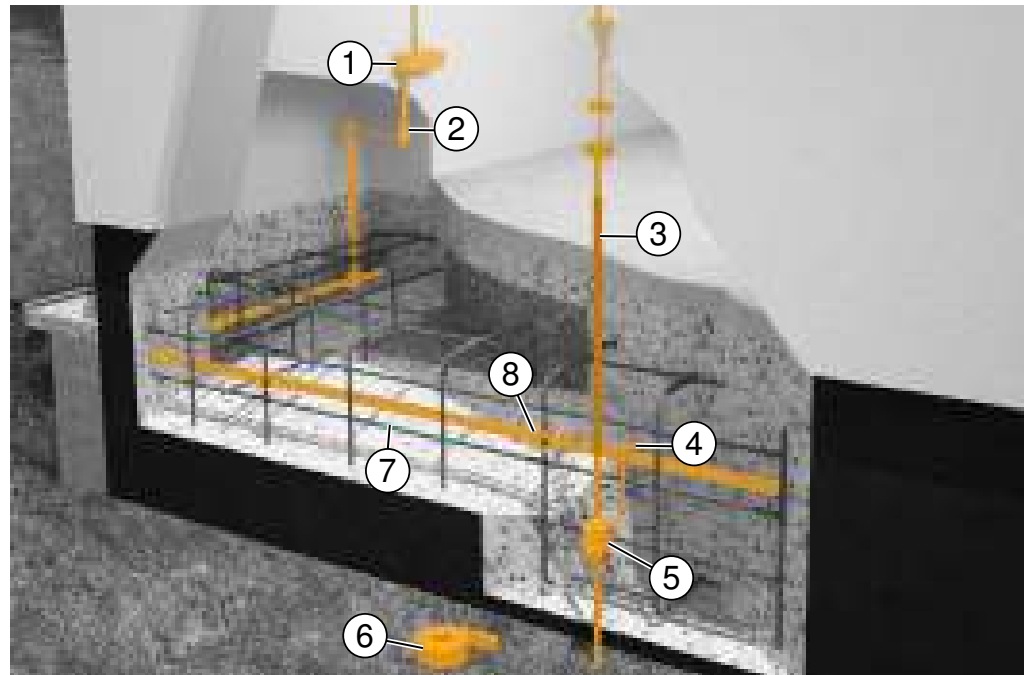

Image 1: Type B foundation earth electrode

- ① Main equipotential busbar (MEB)
- ② Earthing fixed point
- ③ Earth entry rod
- ④ Cross-connector
- ⑤ Cross-connector with corrosion protection
- ⑥ Corrosion protection strip
- ⑦ Flat conductor
- ⑧ Connection terminal for reinforced steels

Note

Connections in the earth must be protected with a corrosion protection strip.

Versions of foundation earth electrodes	
Dimensions	<ul style="list-style-type: none"> • Round conductor (min. diameter 10 mm)¹ • Flat conductor (min. dimensions 30 mm x 3.5 mm)¹
Materials	<ul style="list-style-type: none"> • Bright and galvanised steel (use only with at least 5 cm concrete cladding) • Stainless steel of quality V4A, e.g. material no. 1.4404/1.4571 (use in concrete jacket or directly in the earth possible) • Copper (use in concrete coating or directly in the earth possible)
¹ For transformer stations, VDE 0101 (EN 61936) states that larger cross-sections can be necessary for the maximum short-circuit currents which occur.	

Table 1: Versions of foundation earth electrodes

All metals in contact with the ground or water can corrode. Electrochemical corrosion occurs when different metals are connected with one another in soil, water or molten salt. It can also occur when a single type of metal is embedded in two distinct environments, e.g. steel in earth and concrete.

Material	Physical form	Minimum dimensions		
		Earthing rod	Earth conductor	Earth plate
Copper, tin-plated copper	Cable		50 mm ²	
	Round, solid		Ø 8 mm	
	Strip, solid		20 x 2.5 mm	
	Round, solid	Ø 15 mm		
	Pipe	Ø 20 mm		
	Plate, solid			500 x 500 mm
	Grid plate			600 x 600 mm
Hot galvanised steel	Round, solid		Ø 10 mm	
	Round, solid	Ø 14 mm		
	Pipe	Ø 25 mm		
	Strip, solid		30 x 3 mm	
	Plate, solid			500 x 500 mm
	Grid plate			600 x 600 mm
	Profile ^a	290 mm ²		
Bright steel ^b	Cable	Ø 8 mm	70 mm ²	
	Round, solid		Ø 10 mm	
	Strip, solid		25 x 3 mm	
Copper-coated steel	Round, solid ^c	Ø 14 mm		
	Round, solid ^d		Ø 8 mm	
	Round, solid ^d		Ø 10 mm	
	Round, solid		30 x 3 mm	
Stainless steel ^e	Round, solid		Ø 10 mm	
	Round, solid	Ø 15 mm		
	Strip, solid		30 x 3.5 mm	

^a Various profiles with a cross-section of 290 mm² and a minimum thickness of 3 mm are approved, e.g. cross profiles.
^b Must be embedded in concrete to a depth of at least 50 mm.
^c At least 250 µm copper plating with 99.99% copper content.
^d At least 70 µm copper plating with 99.99% copper content.
^e Chromium ≥ 16%; nickel ≥ 5%; molybdenum ≥ 2%; carbon ≤ 0.08%

Table 2: Materials, form and cross-section according to VDE 0185-561-2 (IEC 62561-2)

Chapter 3.3 Insulated earthing systems

If the concrete is insulated, then there need be no electrical connection to the earth. The insulation means that the concrete dries out to a great extent.

This is, for example, the case with the following versions:

- Perimeter insulation: Heat insulation on the underside and side walls of the foundations
- Black tank: Seals with bitumen strips or polymer-modified bitumen thick coating (KMB)
- White tank: Water-impermeable (WU) concrete to DIN 206-1 and 1045-2 of the quality C25/30
- Poorly electrically conductive earth strata, e.g. made of recycled material or crushed glass

In these cases, a ring earth electrode must additionally be used outside or beneath the concrete foundation. This ring earth electrode in contact with the earth is connected to the functional equipotential bonding conductor of the foundation.

If the earth electrode is installed under the floor plate of the insulated foundation, then the following loop width must be maintained:

- 10 x 10 m with lightning protection measures
- 20 x 20 m without lightning protection measures

Note

For this reason, in large buildings, the earthing system must be installed before the concrete work.

Chapter 3.3.1**Perimeter insulation**

Perimeter insulation is created from heat-insulation plates and is used beneath floor plates and on cellar walls. The use of perimeter insulation does not create an electrically conductive connection between the concrete foundation and the earth.

Perimeter insulation surrounding on all sides

If all the walls, foundations and the bottom of the foundation are surrounded by the perimeter insulation of the structure, then the function of the foundation earth electrode will be restricted or non-existent. For this reason, with insulated foundations, a ring earth electrode must be installed in contact with the earth beneath the foundation and the insulation, in order to guarantee the standard-conformant function of the earthing system. Before installing the perimeter insulation, the earth electrode of stainless steel quality V4A (1.4404/1.4571) must be erected.

Perimeter insulation only on the surrounding walls

If the perimeter insulation is only on the surrounding walls, earth electrode contact is often still intact. The foundation earth electrode can be implemented in the concrete. To ensure contact with the earth, no water-impermeable concrete (WU concrete) may be used.

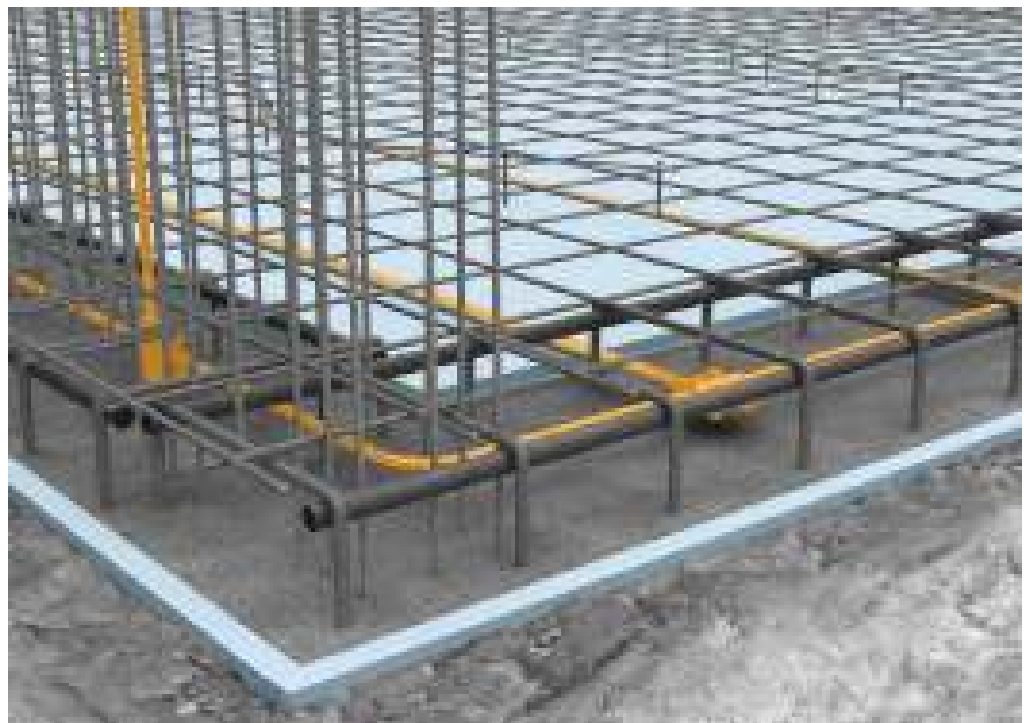

Image 2: Insulated floor plate (perimeter insulation, shown here in blue)

Chapter 3.3.2

Black tank

If the area of the building in contact with the earth is surrounded on all sides by a bitumen or plastic seal, then we speak of a "black tank". Because, in this case, the foundation earth electrode no longer has contact with the earth here, an additional grid ring earth electrode and functional equipotential bonding must be created in the foundation.

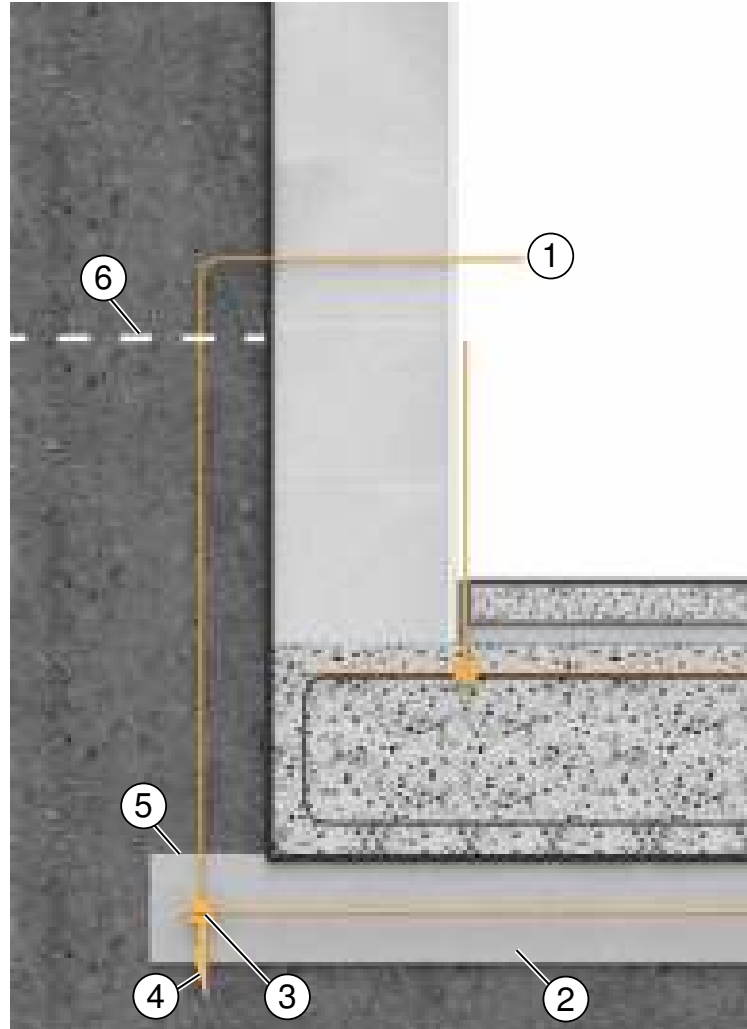

Image 3: Black tank

Legend:

- ① Connection lug, min. 1.5 m
- ② Cleanliness layer
- ③ Ring earth electrode
- ④ Spacer
- ⑤ Min. 5 cm concrete cladding is used as corrosion protection
- ⑥ Maximum groundwater level

The foundation earth electrode within the "black tank" is used for equipotential bonding. Beneath the seal, there must be a second earthing system with at least the same loop width installed in the cleanliness layer or in the earth. Both earthing systems should be connected. On buildings without a lightning protection system, the maximum spacing between the connections should be 20 metres around the periphery of the building. If there is a lightning protection system, there should be a connection on each down-conductor.

Chapter 3.3.3

White tank

A "white tank" is a construction consisting of water-impermeable concrete (WU concrete), in which water cannot penetrate right through the concrete. As with the "black tank", there is no contact between the earth and the foundation earth electrode.

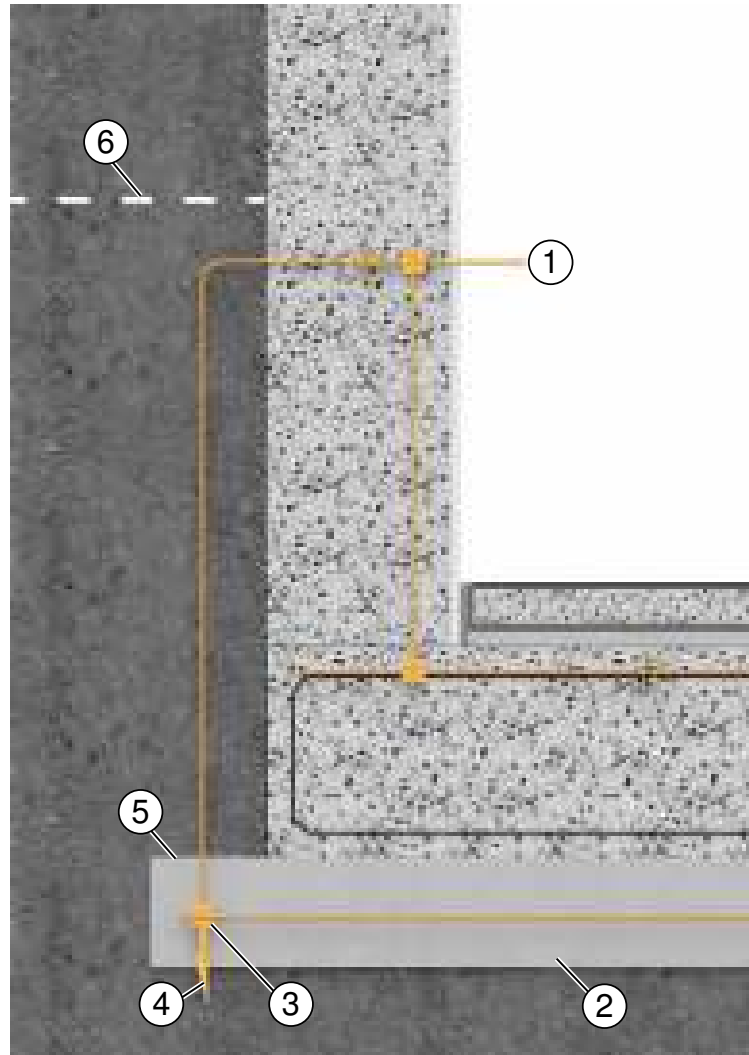

Image 4: White tank

Legend:

- ① Connection lug, min. 1.5 m
- ② Cleanliness layer
- ③ Ring earth electrode
- ④ Spacer
- ⑤ Min. 5 cm concrete cladding is used as corrosion protection
- ⑥ Maximum groundwater level

If there is a lightning protection system and an insulated foundation, two earthing systems must be installed:

- In the foundation: One earth electrode with a 20 x 20 m loop width, in accordance with the foundation earth electrode standard DIN 18014.
- In the earth: One earth electrode with a 10 x 10 m loop width, in accordance with the lightning protection standard VDE 0185-305-3 (IEC 62 305-3)

The insertion of the connection lugs into the building should take place above the highest ground water level. If, for structural reasons, an insertion in the area of the ground water be necessary, then a pressure water-tested sealing sleeve must be used. It prevents the capillary ingress of water into the concrete.



Product	Type	Article number	Figure
Sealing sleeve for round conductors	DW RD10	2360 041	
Sealing sleeve for flat conductors	DW FL30x3.5	2360 043	



Image 5: Bridging of movement joints with an expansion piece

Within the concrete, the foundation earth electrode may not be run over movement joints. Connection lugs should be run out of the wall with earthing fixed points and connected with flexible bridging parts made of copper or aluminium with a cross-section of at least 50 mm². The connection point can be checked at any time through the use of an expansion piece.

Product	Type	Article number	Figure
Expansion piece	1807	5016 142	

Chapter 3.4

Lightning protection earthing

The earthing system distributes the lightning current in the earth. A low earthing resistance (of less than 10Ω) is recommended. To minimise potential differences, all the system parts, such as the lightning protection, power supply and IT systems, must be connected to the same earthing system. The earthing system must arrest the lightning current into the earth with low resistance, in order to avoid surge voltages. The external lightning protection system is connected to the earth via the earthing system.

If there is a lightning strike, a large voltage de-energises at the earthing resistor of the building. This voltage, de-energised by the building, generates a voltage funnel in the earth, endangering the people above it. At points with increased numbers of people, these hazardous potential differences should be reduced by installing additional parallel and meshed conductors around the foundation earth electrode as ring earth electrodes in the earth (see chapter 3.5 on page 14).

Chapter 3.4.1

Ring earth electrode

A ring earth electrode is a closed ring of strip or round conductor, created in the earth around the structure. For reasons of corrosion protection, the foundation earth electrode standard DIN 18014 stipulates that, in the earth, only the stainless steel quality V4A (1.4404/1.4571) may be installed.

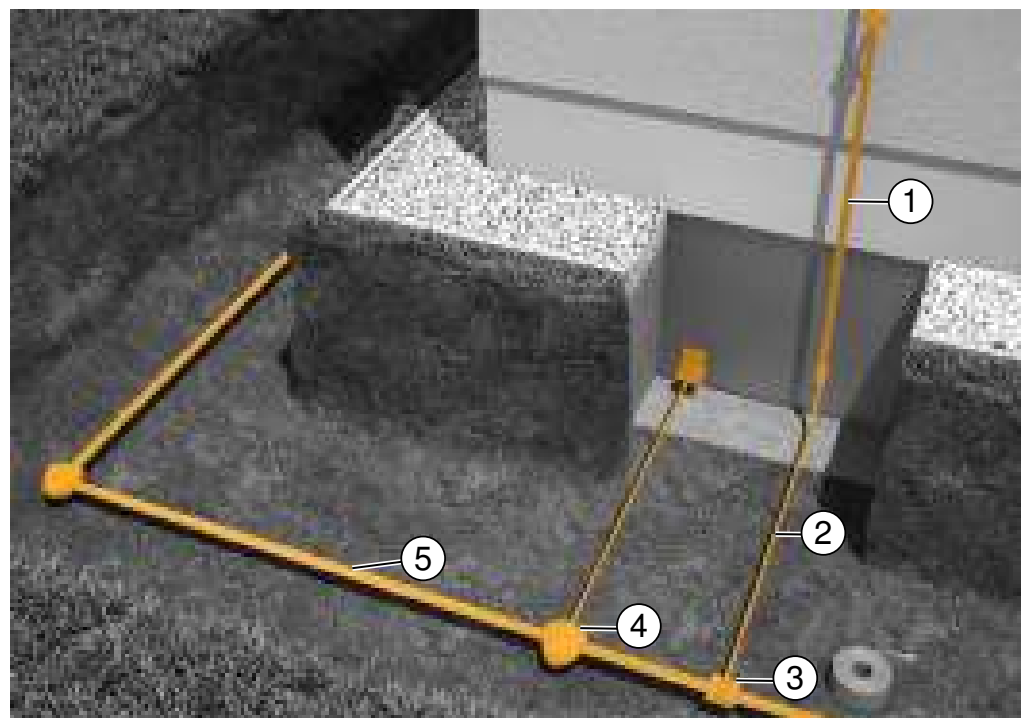

Image 6: Type B ring earth electrode

Legend:

- ① Earth entry rod
- ② Round conductor
- ③ Cross-connector
- ④ Corrosion protection strip
- ⑤ Flat conductor

Note

The ring earth electrode should have direct contact with the earth along at least 80% of its length. Routing should be at least 0.5 metres deep (frost depth) and at a distance of 1.0 metres to the building.

Chapter 3.4.2

Earth rods

Earth rods are inserted vertically into the earth. The ideal installation depth is 9 m. This reaches the permanently moist areas in the earth. Good contact to the earth is created and the step voltage is also reduced. With a measured resistance of under 10Ω , a sufficient installation depth can be assumed. A greater installation depth of the earth rod often only reduces the earthing resistance to a small extent. The earthing resistance must be checked on installation. If the earthing resistance is not reduced at an increasing installation depth, parallel installation of multiple earth rods is wise. To minimise the mutual influence of the earth rods, the spacing of the parallel earth electrodes must correspond to at least the length of the inserted earth electrodes.

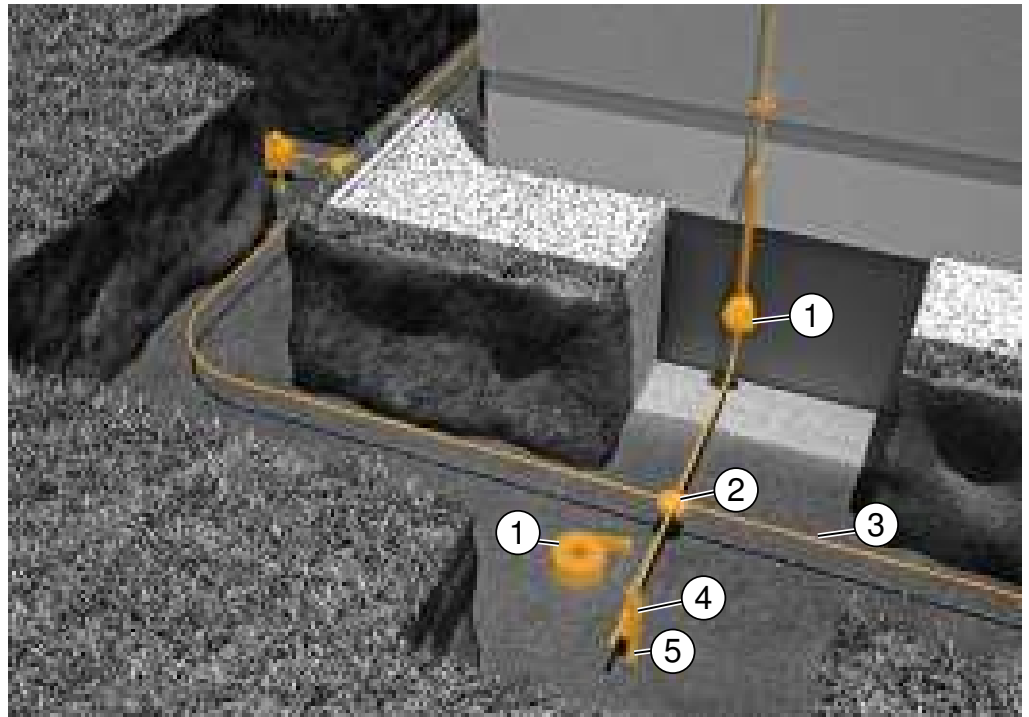

Image 7: Type A – earth rods with ring equipotential bonding

Legend:

- ① Corrosion protection strip
- ② Cross-connector
- ③ Round conductor
- ④ Connection clips
- ⑤ Earthing rod

OBO offers earth rods in various materials and versions.



Image 8: Earth rod versions

Legend	Type	Description
①	OMEX	With soft metal inlay and hardened hexagonal pin for difficult soil conditions
②	BP	Very good contacting properties through soft metal inlay in the borehole
③	Standard	With double (Ø 20 mm) or triple bundling (Ø 25 mm) for torsion-resistant connections
④	Light Earth	Pipe earth electrodes with very small weight for light to medium-difficult soil conditions

Table 3: Overview of earth rod versions

You can find matching impact heads for hand-held hammers as well as hammer inserts for vibration hammers in the OBO product range.

Note

The individual earth rods must be interconnected and connected to the building earth electrodes. If the connection is not possible outside the building, then this can also take place in the building (cellar).

Chapter 3.5

Potential control against step voltages

The step voltage is the voltage between a person's feet placed 1 m apart. Here, the compensating current flows between the person's feet through their body. In entrance areas or in front of lookout towers, a densely looped earthing system is installed to minimise step voltage and to protect people. The lightning current is distributed through the metallic earthing system. Earth rods route the current into the earth and the voltage drop on the earth's surface and the resulting step voltage are reduced. Here, stainless steel of quality V4A (1.4404/1.4571) should be used as a material.

Option 1: Potential control through ring earth electrodes

Additional ring earth electrodes are routed around the foundation earth electrode and connected with one another in a grid format. As the distance from the rod or down-conductor increases, the ring earth electrode is routed 0.5 m deeper each time at the usual spacing of 3 m.

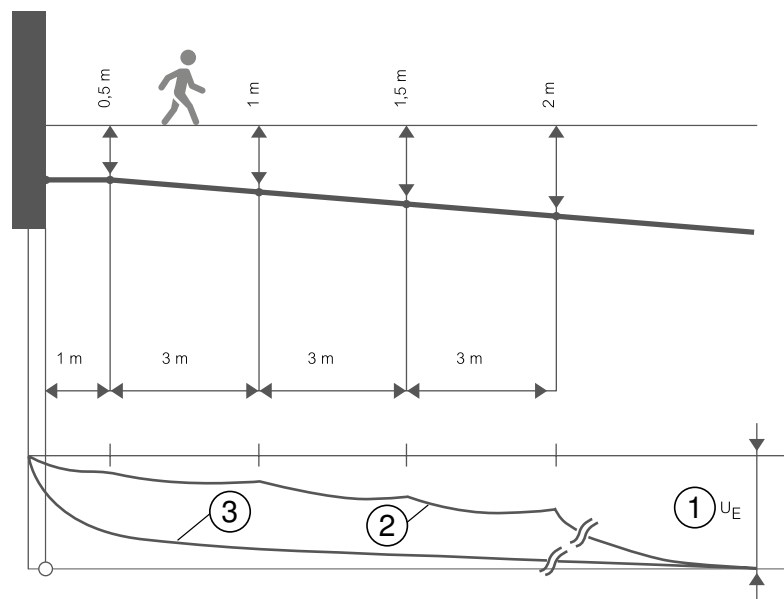

Image 9: Potential control on a streetlight pole

Legend:

- ① Earthing voltage U_E
- ② Controlled
- ③ Uncontrolled, without potential control

Option 2: Potential control through mesh grid

In refuges or transport stops, potential control through a tight metal grid is wise. The mesh is installed at a small depth (max. 0.25 m) under the earth's surface. The metallic mesh rods should have a minimum diameter of 3 mm and a maximum grid width of 0.25 x 0.25 m. To minimise the corrosion in the earth, the use of high-quality stainless steel V4A (1.4404/1.4571) is necessary. The mesh grids are screwed to each other using connection terminals and connected to the existing earthing system. This tightly meshed system greatly reduces the step voltage per metre and reduces the risk to people.

Note

Nonetheless, hazardous step voltages are possible directly at the end of the grids. Additional potential control measures should be taken here.

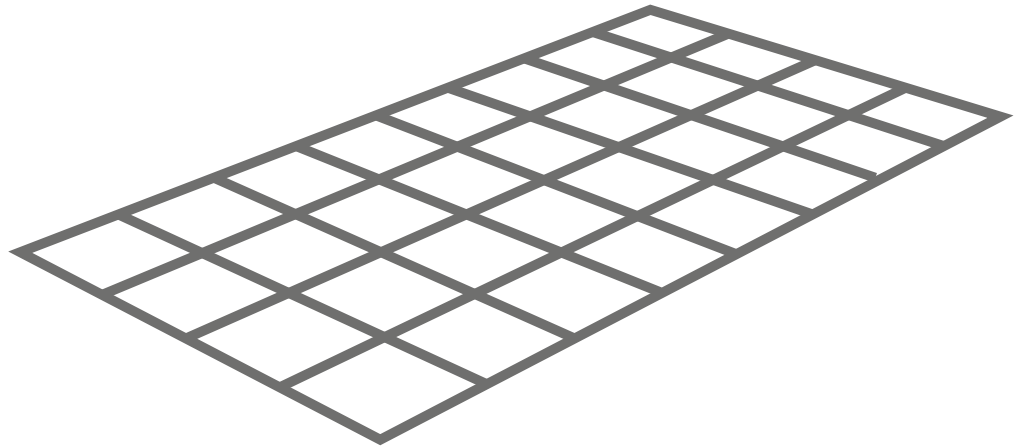

Image 10: Mesh grid for potential control

Chapter 3.6

Touch voltage

If there is a lightning stroke, the lightning current is routed through the down-conductors into the earthing system and the earth. The resistance of the down-conductor and the earth causes a voltage drop, which can lead to so-called touch voltage. The touch voltage is the voltage between a component (e.g. the down-conductor) and earth potential. The current flows from the hand to the foot through the body. The potential hazard must be reduced by technical measures, e.g. a control earth electrode.

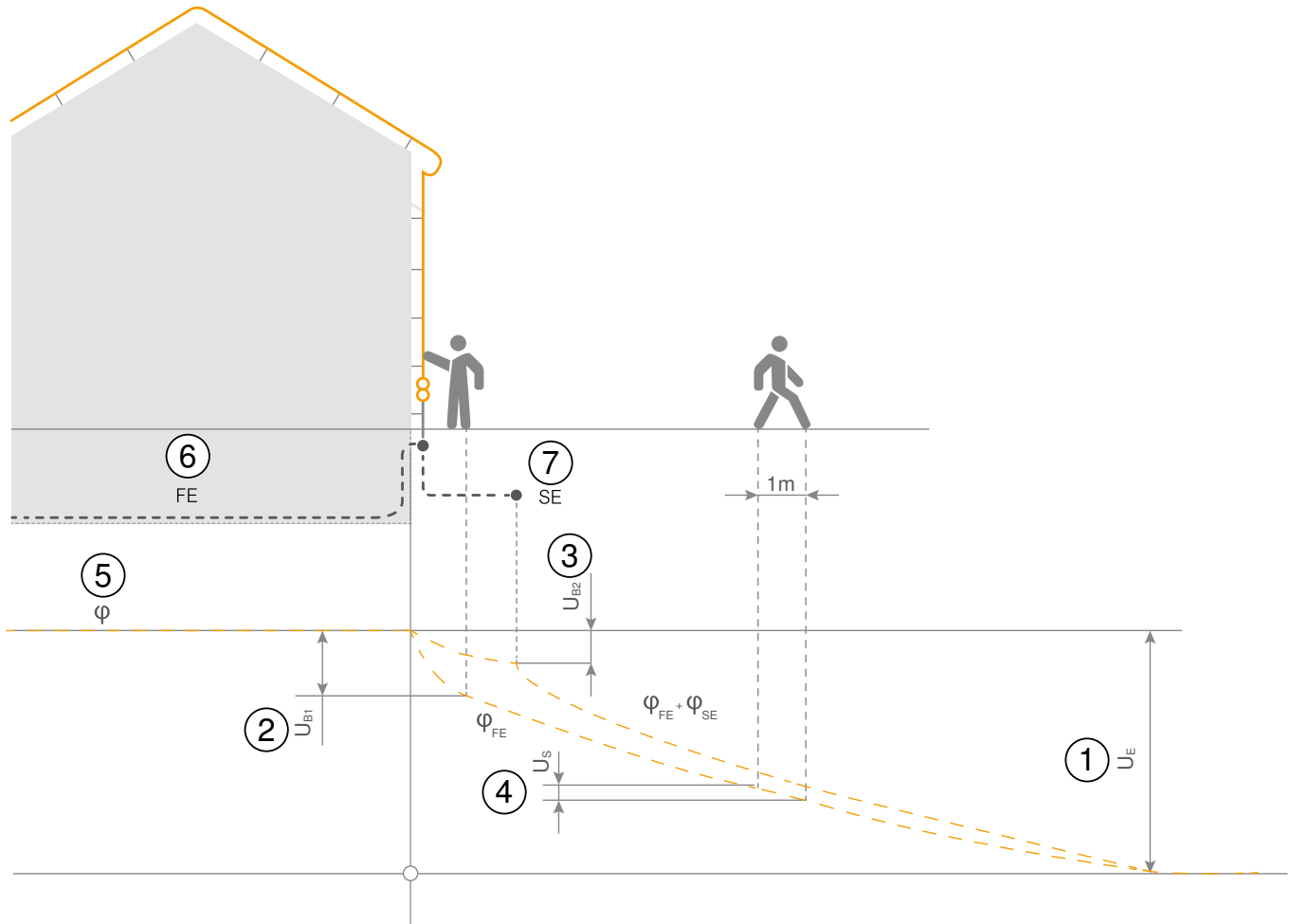

Image 11: Electrical potential on the earth surface and voltages as current passes through the foundation earth electrode (FE) and control earth electrode (CE)

Legend:

- ① U_E : Earthing voltage
- ② U_{B1} : Touch voltage without potential control (on foundation earth electrode)
- ③ U_{B2} : Touch voltage with potential control (foundation earth electrode and control earth electrode)
- ④ U_S : Step voltage (without control earth electrode)
- ⑤ φ : Earth surface potential
- ⑥ FE: Foundation earth electrode
- ⑦ CE: Control earth electrode (ring earth electrode)

Note

If a control earth electrode or the insulation around the down-conductor is not possible, then barriers must be created or warning information attached.

Chapter 3.7

Labelling the connection lugs

During the construction phase, metal connection lugs pose a risk of injury to people. For this reason, the connection lugs of the earthing system must be marked clearly during the entire construction phase (DIN 18014).

Product	Type	Article number	Figure
Protective cap for flat conductors and round conductors, retro-reflective	ProtectionBall	5018014	

Chapter 3.8

Earthing systems for wind power plants

The earthing system is the basis for the protection of people, fault-free operation of the electrical system and the basis of the lightning protection system. The main earthing busbar creates the connection from the earthing system to the electrical resources and the components of the lightning and surge protection. If there is a lightning strike in the wind power plant (WPP), then the earthing system must distribute the currents into the earth at low impedance. VDE 0127-24 (IEC 61400-24) describes the lightning protection of wind power plants in detail.

If there is a transformer station in the foot or immediate vicinity of the tower, then the possible short-circuit voltages should be taken into account. The interconnected earthing systems of the tower and the transformer station may not exceed a value of 10 Ω . If this is exceeded, additional ring or earth rods are required. In addition, the protection measures and switch-off conditions of the electrical system must be guaranteed.

Note

In wind parks, each tower must possess its own earthing system, even if this is connected to the earthing system of the other towers, as is standard.

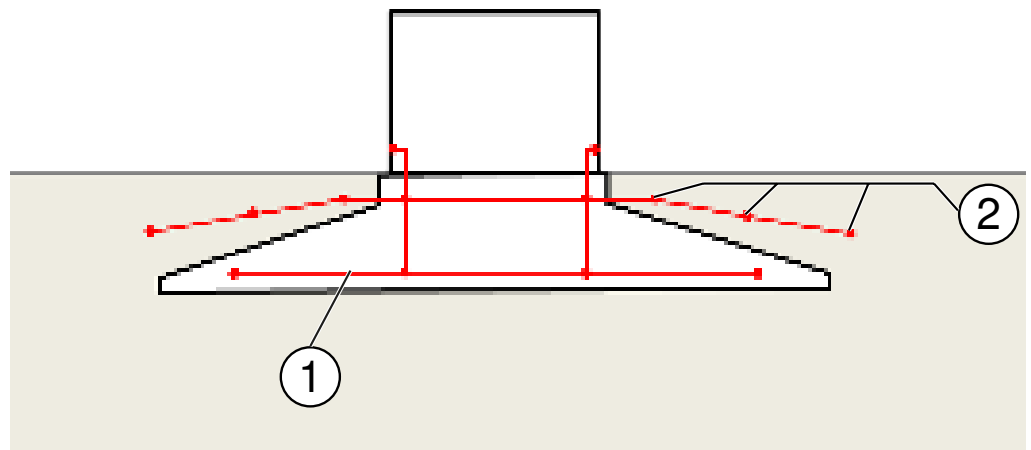

Image 12: Foundation and ring earth electrodes of a wind power plant

Legend:

1. Foundation earth electrode
2. Ring earth electrode



Image 13: Earthing system of a wind power plant

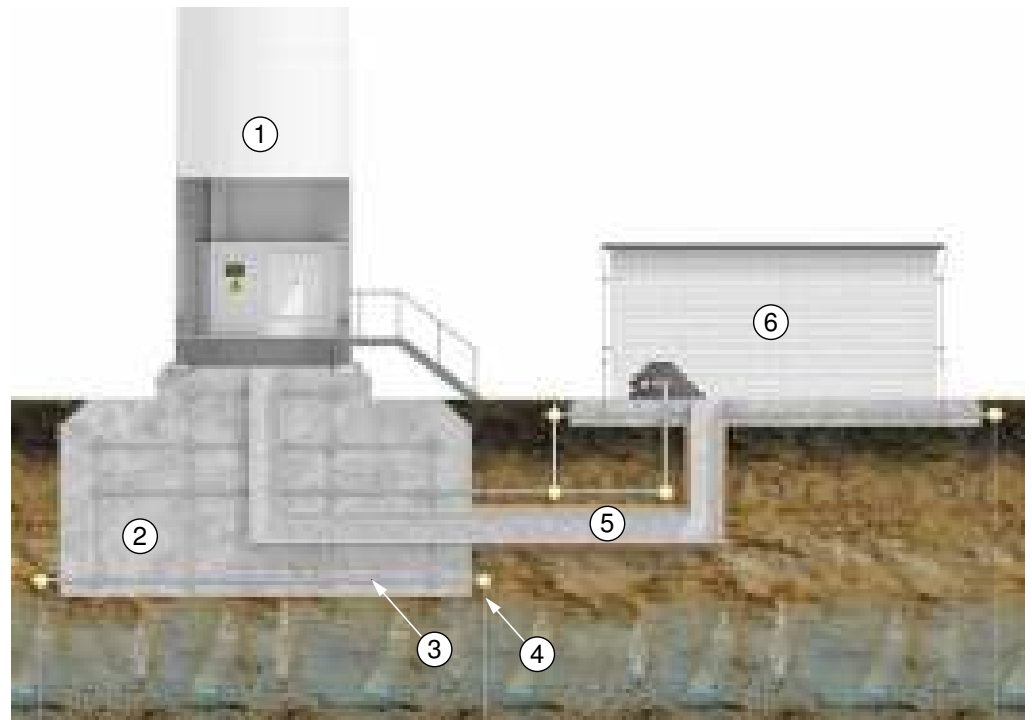

Image 14: Earthing system of a wind power plant with additional building

Legend:

1. Tower
2. Reinforced concrete foundation
3. Earthing grid in the concrete foundation
4. Earth rod and ring earth electrode
5. Cable duct
6. Additional building

Hazardous step and touch voltages can be prevented by a ring earth electrode which controls potential. Earthing systems in the earth must be in stainless steel quality V4A (1.4404/1.4571). VDE 0127-24 (IEC 61400-24) provides information on this and refers to VDE 0140-479 (IEC 60479).

According to the lightning protection standard for wind power plants VDE 0127-24 (IEC 616400-24), all metallic structures and installations of the WPP must be connected with the lightning protection equipotential bonding either directly or using suitable lightning arresters in accordance with VDE 0185-305 (EN 62305).

The lightning protection standard VDE 0185-305-3 (IEC 62305-3) specifies earth electrodes of type A and type B.

These arrangements are described as follows for wind power plants (WPP):

Earth, type A:

According to VDE 0127-24 (IEC 61400-24 Appendix I), the type A arrangement cannot be used for the earthing system of the WPP but only for additional buildings, housing offices or measuring technology, for example. The type A earthing system consists of horizontal and/or vertical earth electrodes, which are connected to at least two down-conductors on the building.

Earth, type B:

According to VDE 0127-24 (IEC 61400-24 Appendix I), the type B arrangement must be used for the earth electrode system of the WPP. This consists of a ring earth electrode in the earth or an earthing system as a foundation earth electrode. The earthing system must be connected to the tower of the WPP. In addition, the earthing system of the tower and the existing operation building must be connected by a meshed earthing network. This earthing system, connected over a wide area, minimises potential differences.

Note

To protect people and reduce step voltage, there must be additional potential control (ring earth electrode) in the entrance area.

Chapter 4.

Documentation

The current foundation earth electrode standard DIN 18 014 and also the safety standard for the erection of low-voltage systems VDE 0100-600 require documentation.

The documentation must contain the following elements:

- Plans and versions of the connection lugs
- Photos of the installed earthing system with detailed photographs
- Results of the continuity measurements
- Results of the measurements of the earthing resistances

Note

There must be a continuity resistance value $\leq 0.2 \Omega$ between the connection parts. The resistance should be measured for the first time before concreting.

Chapter 5. Selection aid

OBO selection aid for earthing systems to DIN 18014 and VDE 0185-305-3 (IEC 62305-3):

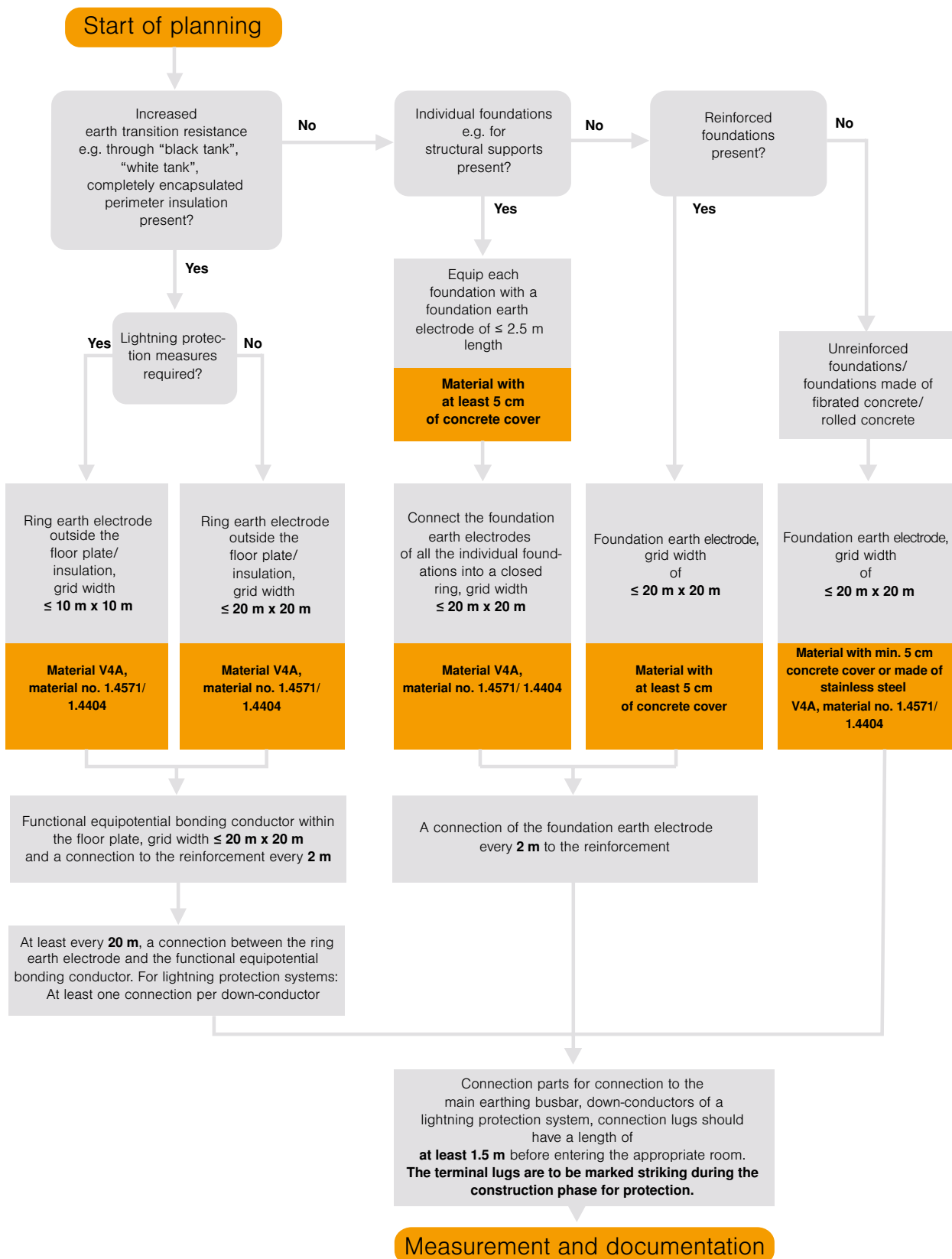

Image 15: Source: Selection aid for earthing systems, OBO Bettermann order no. 9131908

Chapter 6.

Conclusion

The earthing system is the basis for the entire electrical system. Together with the equipotential bonding system, a conductive and low-resistance connection to the local earth is created. Voltage differences between the connected parts are shorted and a reference potential is generated. The safety conditions and switch-off systems can only reach their protection aims when the system is implemented correctly.

Besides correct planning, the installation must be checked and documented. The continued protective action of the earthing system must be ensured through regular maintenance and testing. Besides the state of the art and the named standards, the directives of the local power generating company must be complied with.

A correctly installed earthing system, together with lightning and surge protection devices, can minimise damage and failures.

Additional information on the creation of foundation and ring earth electrodes to DIN 18014 and VDE 0185-305-3 (IEC 62305-3) can be found in the "Selection aid for foundation and ring earth electrodes to DIN 18014" under the following link obo.eu/auswahlhilfe-erdung.

Chapter 7.

Literature notes

Lightning protection standard:

- VDE 0185-305 (IEC 62305)

Lightning protection components standard:

- VDE 0185-561-2 (IEC 62561-2)

Low-voltage electrical installations:

- VDE 0100 (IEC 60634) Low-voltage electrical installations
- VDE 0100-410 (IEC 60634-4-41) Protection against electric shock
- VDE 0100-534 (IEC 60634-5-534) Surge protection devices (ÜSE)
- VDE 0100-540 (IEC 60634-5-54) Selection and erection of electrical resources
- VDE 0800-2-310 (EN 50310) Earthing and equipotential bonding in buildings with information technology equipment

Earthing systems and protective conductors

- DIN 18014 Foundation earth electrodes
- DIN 18015-1 Electrical installations in residential buildings

Wind power plants

- VDE 0127-24 (IEC 61400-24) Lightning protection for wind power plants

Lightning protection guide

- OBO Bettermann Order no. 9131970

OBO Bettermann GmbH & Co. KG

PO Box 1120

58694 Menden

Germany

Customer Service Germany

Tel.: +49 (0)2373 89-1700

Fax: +49 (0)2373 89-1238

E-mail: Export@obo.de

www.obo-bettermann.com

THINK CONNECTED.