

SWIFTS[®] CABLE TRAY

PRODUCT TECHNICAL GUIDE



Global strength built on local knowledge

Legrand is the global specialist in electrical and digital building infrastructures. Innovation is the driving force behind its development. With an increasing investment in research and development (circa 5% of sales) and more than 4,000 active patents, the Legrand Group is focused on maintaining a high rate of new product launches that present innovative solutions to the market.

CORPORATE SOCIAL RESPONSIBILITY

Legrand's 2014-2018 CSR roadmap is a natural extension to the governance and sustainable development approach in which the company has been engaged for many years. The CSR roadmap firmly reasserts Legrand's commitment to sustainable development.



BUILDING SERVICES



INFRASTRUCTURE



PROCESSING INDUSTRIES



HEAVY INDUSTRIES

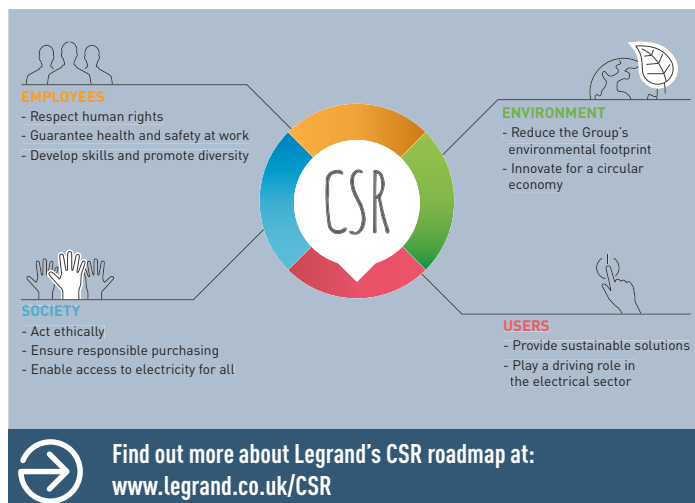



INTRODUCTION

Legrand... the cable management expert	2
Swifts cable tray... the quick fit choice	4
Swifts cable tray... faster with Swiftclip	6
One innovative bracket... endless configurations	8

PRODUCT SELECTION

SWIFTS CABLE TRAY SYSTEMS	
Selection charts	12-15
Straight lengths, couplers and fittings	
Light duty (SS)	16-17
Medium duty (MRF)	18-19
Heavy duty (SRF)	20-21
Extra heavy duty (XRF)	22-23
Supports, ancillary items, covers and fasteners	24-27
SWIFTRACK CHANNEL SUPPORT SYSTEM	
Channel and channel nuts	28
Cantilever arms	29
Framework brackets, clamps and accessories	30-31
Standard fixings and fasteners	32-33

TECHNICAL SPECIFICATIONS

SWIFTS CABLE TRAY SYSTEMS	
Light duty (SS)	
Straight lengths and coupling detail	36-37
Fittings	38-45
Medium duty (MRF)	
Straight lengths, couplers, universal bracket and fishplate	46-51
Fittings	52-63
Heavy duty (SRF)	
Straight lengths, couplers, universal bracket and fishplate	64-69
Fittings	70-83
Extra heavy duty (XRF)	
Straight lengths and couplers	84-85
Fittings	86-93
Supports, ancillary items and covers	94-105
SWIFTRACK CHANNEL SUPPORT SYSTEM	
Single channels – plain and slotted	106
Back-to-back channels	107
Assembly – fasteners and channel nuts	107
Cantilever arms	108-109
Framework brackets	110-113
Beam clamps, pipe clamps and accessories	113-115

DESIGN NOTES

Selecting the right finish	118-123
Finishes	124-127
Installation of services	128-135
Structural support characteristics	136-143
Packaging, handling, storage and safety	144-145
Relevant British Standards	146-147
Protection classifications	149

Legrand

the cable
management
expert

Complete cable management solutions

Using its global strength and market leading position, Legrand has developed a complete range of cable management solutions, including:

- **Swifts cable ladder**
- **Swifts cable tray**
- **Salamandre distribution trunking and lighting trunking**
- **Cablofil steel wire cable tray**
- **Floor systems**
- **Perimeter systems**

Specification data for engineering software systems

As part of its ongoing commitment to customer support, Legrand's cable management ranges have been integrated into a number of plant design modelling systems.



Find out more about Legrand's 3D modelling capabilities at: www.legrand3d.co.uk



SWIFTS
CABLE LADDER



CABLOFIL STEEL
WIRE CABLE TRAY



SALAMANDRE
DISTRIBUTION TRUNKING



FLOOR SYSTEMS



Swifts cable tray... Quality assured UK manufacturing

Swifts cable tray and ladder ranges have been designed and manufactured in Scarborough (UK) since the 1960's. Our inhouse galvanising facility and strict quality control guidelines ensure that every product is finished to the highest possible standard.

Legrand Electric holds ISO 9001 : 2008 Quality Assessment Registrations from Bureau Veritas.

All of Legrand's UK manufacturing sites are accredited to ISO 14001 : 2004 Environmental Management System.



Support from design to installation

With in-depth knowledge and experience, our expert cable management team provides customers with support and advice for any installation... including bespoke solutions (specials) from our in-house design team that can cope with the most demanding requirements for the most challenging projects.



Introducing Swiftclip

The fast-fit alternative to traditional nuts and bolts, providing a quicker and easier way to connect length to length, length to fitting and for securing to supports.



See page 6 to find out more...

Swifts[®] cable tray

the quick fit choice

The distinctive slot pattern on Swifts cable tray provides installers with total flexibility. Available in four types, this strong, durable system has been designed with fast-fit features that make it quick and easy to install, both inside and outside.

Product ranges			
SS - LIGHT DUTY Tray depth: 12 mm (for 50 - 225 mm widths) 18 mm (for 300 mm width) Finishes: G (hot dip galvanised) PG (pre-galvanised) S (stainless steel)	MRF - MEDIUM DUTY Tray depth: 25 mm Finishes: G (hot dip galvanised) D (deep galvanised) PG (pre-galvanised) S (stainless steel) E (powder coated)	SRF - HEAVY DUTY Tray depth: 50 mm Finishes: G (hot dip galvanised) D (deep galvanised) PG (pre-galvanised) S (stainless steel) E (powder coated)	XRF - EXTRA HEAVY DUTY Tray depth: 80 mm Finishes: G (hot dip galvanised) D (deep galvanised) S (stainless steel)

Fit faster. Save money.

As with all Legrand cable management systems, Swifts cable tray is a complete system with a range of accessories – all packed with innovative features that lower the total cost of your installation. From an integral coupler system on all fittings to unique, adjustable bends and risers, as well as the new Swiftclip (p. 6) and the universal bracket (p. 8), it's all designed to provide a strong, long-lasting solution while saving you money as well as time.



Flat bends are available in 30, 45, 60 and 90°. All fittings have integral base couplers and side lugs that hold the fitting in place making it easier to assemble.



Adjustable flat bends allow the installer to adjust the tray to any angle from 30° to 90°. A number of predetermined fixing locations allow the fitting to be fixed at 7.5° increments.



Adjustable risers slide inside the cable tray and can be adjusted to almost any length or any angle up to 90°.



Easi-clip for fast connection of MRF and SRF tray to channel.

Swifts[®] cable tray just got faster

...with Swiftclip

Swifts cable tray is packed with time-saving design features that make it quicker and easier to get the job done



Swiftgrip

A heavy duty option for connecting MRF and SRF lengths of all sizes. Swiftgrip is robust, durable and provides a fast-fit alternative to nuts and bolts.



See page 18 to find out more...



Now, Legrand has applied its innovative thinking and heritage in cable management to make it even faster.

Introducing Swiftclip: the new, fast-fit alternative to conventional nuts and bolts that seamlessly connects lengths and fittings, making light work of any installation.



**4 TIMES
FASTER TO FIT**

Independent tests by BSRIA confirm that Swiftclip is at least four times faster to fit than standard nuts and bolts*. With just two clips per joint, it not only saves on the number of components needed, but also saves on time, meaning a reduced total installed cost.



**STRONGER,
FASTER, FITTER**

Swiftclip isn't just built for speed. It also offers uncompromised strength that meets the requirements of British Standards.

*When fitting length to length or length to fitting. Full report available on request from Legrand.

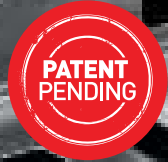

SWIFTCLIP CONNECTS LENGTH TO LENGTH AND LENGTH TO FITTING

READY...

Locate coupler across underside of tray joint

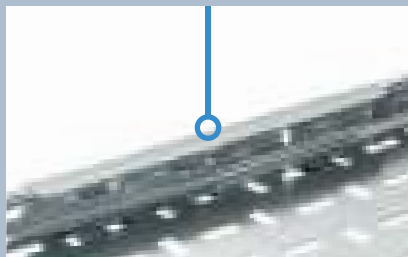

SET...

Insert joggled head of the Swiftclip through both tray and coupler slots

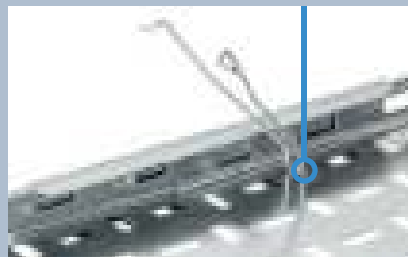

GO.

Pass each Swiftclip leg through the tray and coupler and you're done



COMPATIBLE WITH EXISTING SYSTEM

Designed to integrate with the existing Swifts cable tray system, Swiftclip can be used with medium (MRF) and heavy duty (SRF) in 50 to 300mm widths. The entire system offers excellent earth continuity without the use of additional components.



GALVANISED OPTIONS

Available to suit external and internal applications, Swiftclip ensures your Swifts installation will stand the test of time.



CUTS TOTAL INSTALLED COST

Packed with fast-fit features, the savings in time and effort of installing Swifts, as well as its durable design reducing the need for maintenance, vastly cut the total installed cost of the system.



NO TOOLS NEEDED

With the new Swiftclip, lengths and fittings of Swifts cable tray can be fitted without the use of specialist tools – making it even faster, safer and easier to fit.



A simple,
versatile
solution to
on-site
fabrication

Overcome obstacles and challenges on-site with the universal bracket. Designed for use with SRF or MRF cable tray, the universal bracket is a must-have for any toolkit. This simple, innovative addition to the range offers true versatility when faced with demanding site conditions.

Swifts[®] cable tray

One innovative bracket...
endless configurations

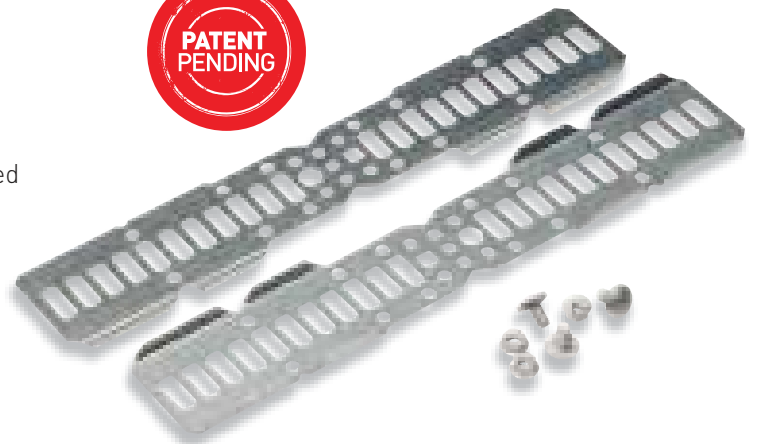

The universal bracket can be hand folded, bent, split or hinged to offer a multitude of functions. The unique design provides the flexibility to cope with demanding on-site requirements.

Supplied with 'quick bolt fasteners' and driver tool.

Use in conjunction with the universal fishplate to add additional support and cable protection.

FLANGE ASSEMBLY

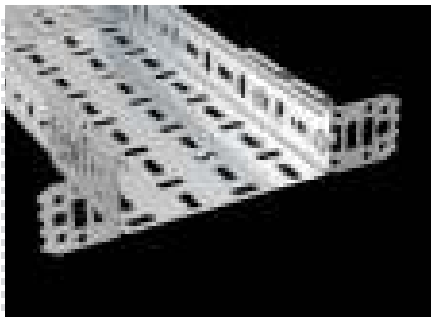

Snap and fold bracket to create a flange

INTERNAL RISER



Snap and hinge bracket to create internal or external risers from -90 to +90 degrees

FLAT BEND

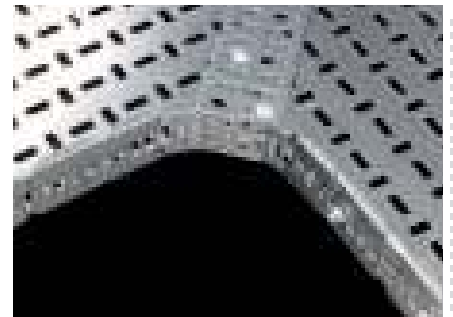

Fold or bend bracket to desired angle. For wider installations add a fishplate for additional support

SIDE DROPOUT



Create specialist functions such as side dropouts by folding and hinging brackets

OFFSET FOURWAY

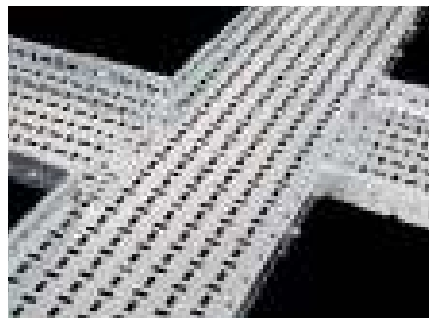

Fold or bend 2 pairs of brackets to form specialist offset fourways

HANDED REDUCER



Create left, right or straight reducers by simply bending the bracket to suit the application

The background of the page features a close-up, artistic shot of a bundle of electrical cables. The cables are bundled together and curve downwards from the top right towards the bottom left, creating a sense of depth and movement. The lighting is soft, highlighting the texture of the insulation and the metallic sheen of the conductors.

product selection



PRODUCT SELECTION

SWIFTS CABLE TRAY SYSTEMS	
Selection charts	12-15
SS LIGHT DUTY CABLE TRAY	
Straight lengths	16
Flat bends	16
Inside, outside and adjustable risers	16-17
Equal tees	17
4 way crosspieces	17
Straight reducers	17
MRF MEDIUM DUTY RETURN FLANGE CABLE TRAY	
Straight lengths	18
Couplers sets	18
Fixing options – quick bolt fasteners, Swiftclip and Swiftgrip	18
Flat and adjustable bends	19
Inside and outside risers	19
Adjustable and extra long adjustable risers	19
Equal and unequal tees	19
4 way crosspieces	19
Straight reducers	19
SRF HEAVY DUTY RETURN FLANGE CABLE TRAY	
Straight lengths	20
Couplers sets	20
Fixing options – quick bolt fasteners, Swiftclip and Swiftgrip	20
Flat and adjustable bends	21
Inside and outside risers	21
Adjustable and extra long adjustable risers	21
Equal and unequal tees	21
4 way crosspieces	21
Straight reducers	21
SRF to MRF straight reducers	21
XRF EXTRA HEAVY DUTY RETURN FLANGE CABLE TRAY	
Straight lengths	22
Couplers sets	22
Flat bends	22
Inside and outside risers	23
Equal and unequal tees	23
4 way crosspieces	23
Straight reducers	23
Fittings – universal brackets and fishplates	24
Supports	25
Ancillary items and covers	26
Fasteners	27
SWIFTRACK CHANNEL SUPPORT SYSTEM	
Channels and channel nuts	28
Cantilever arms	29
Framework brackets, clamps and accessories	30-31
Standard fixings and fasteners	32-33

Swifts® SS light duty and MRF medium duty

cable tray systems

SS LIGHT DUTY									
	TRAY		COUPLERS	FITTINGS					
	Widths (mm)	Straight lengths (3 m) F = finish	Coupler sets F = finish No separate couplers are needed, p. 16	Universal bracket F = finish No universal brackets are available on SS light duty	90° Flat bends ¹ F = finish	Adjustable bends F = finish No adjustable bends are available on SS light duty	90° Inside risers F = finish	90° Outside risers F = finish	Adjustable risers F = finish
SS LIGHT DUTY	50	SSL 50 F	–	–	SSB 50 F	–	SSIR 50 F	SSOR 50 F	SSAR 50 F
	75	SSL 75 F	–	–	SSB 75 F	–	SSIR 75 F	SSOR 75 F	SSAR 75 F
	100	SSL 100 F	–	–	SSB 100 F	–	SSIR 100 F	SSOR 100 F	SSAR 100 F
	150	SSL 150 F	–	–	SSB 150 F	–	SSIR 150 F	SSOR 150 F	SSAR 150 F
	225	SSL 225 F	–	–	SSB 225 F	–	SSIR 225 F	SSOR 225 F	SSAR 225 F
	300	SSL 300 F	–	–	SSB 300 F	–	SSIR 300 F	SSOR 300 F	SSAR 300 F

MRF MEDIUM DUTY									
	TRAY		COUPLERS	FITTINGS					
	Widths (mm)	Straight lengths (3 m) F = finish	Coupler sets F = finish	Universal bracket F = finish	90° Flat bends ¹ F = finish	Adjustable bends F = finish	90° inside risers ¹ F = finish	90° outside risers ¹ F = finish	Adjustable risers ² F = finish
MRF MEDIUM DUTY	50	MRFL 50 F	MRFC50 F	MRFUB F	MRFB 50 F	MRFAB 50 F	MRFIR 50 F	MRFOR 50 F	MRFAR 50 F
	75	MRFL 75 F	MRFC F	MRFUB F	MRFB 75 F	MRFAB 75 F	MRFIR 75 F	MRFOR 75 F	MRFAR 75 F
	100	MRFL 100 F	MRFC F	MRFUB F	MRFB 100 F	MRFAB 100 F	MRFIR 100 F	MRFOR 100 F	MRFAR 100 F
	150	MRFL 150 F	MRFC F	MRFUB F	MRFB 150 F	MRFAB 150 F	MRFIR 150 F	MRFOR 150 F	MRFAR 150 F
	225	MRFL 225 F	MRFC F	MRFUB F	MRFB 225 F	MRFAB 225 F	MRFIR 225 F	MRFOR 225 F	MRFAR 225 F
	300	MRFL 300 F	MRFC F	MRFUB F	MRFB 300 F	MRFAB 300 F	MRFIR 300 F	MRFOR 300 F	MRFAR 300 F
	450	MRFL 450 F	MRFC F	MRFUB F	MRFB 450 F	–	MRFIR 450 F	MRFOR 450 F	MRFAR 450 F
	600	MRFL 600 F	MRFC F	MRFUB F	MRFB 600 F	–	MRFIR 600 F	MRFOR 600 F	MRFAR 600 F
	750	MRFL 750 F	MRFC F	MRFUB F	MRFB 750 F	–	MRFIR 750 F	MRFOR 750 F	MRFAR 750 F
	900	MRFL 900 F	MRFC F	MRFUB F	MRFB 900 F	–	MRFIR 900 F	MRFOR 900 F	MRFAR 900 F

1 : 60°, 45° and 30° angles need to have angle included in order code, ie. MRFB 300 60 G
 2 : Extra long adjustable risers also available. Code as adjustable riser and insert X. Example : MRFAXRWF (see p. 19)

FITTINGS			
Equal tees F = finish 	Unequal tees B = branch F = finish No unequal tees are available on SS light duty 	4 way crosspieces F = finish 	Straight reducers K = reduced width F = finish
SST 50 F	-	SSX 50 F	-
SST 75 F	-	SSX 75 F	SSR 75 KF
SST 100 F	-	SSX 100 F	SSR 100 KF
SST 150 F	-	SSX 150 F	SSR 150 KF
SST 225 F	-	SSX 225 F	SSR 225 KF
SST 300 F	-	SSX 300 F	SSR 300 KF

Key : selecting SS light duty fittings

Replace the letters shown in red with your choice from the following options :

A = Angle (°) : 60, 45 and 30 (90 standard and does not need to be included in order code)

F = Finish : **G** (hot dip galvanised after manufacture), **PG** (pre-galvanised steel), **S** (stainless steel)

K = Narrowed width when using a reducer (mm) : 50, 75, 100, 150, 225

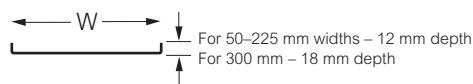

Adjustable riser. See p. 17

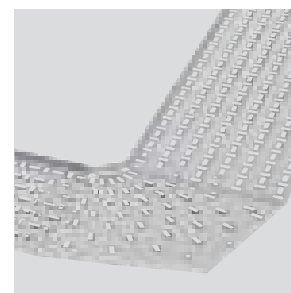

Flat bend. See p. 16

FITTINGS			
Equal tees F = finish 	Unequal tees B = branch F = finish 	4 way crosspieces F = finish 	Straight reducers K = reduced width F = finish
MRFT 50 F	MRFUT 50 BF	MRFX 50 F	-
MRFT 75 F	MRFUT 75 BF	MRFX 75 F	MRFR 75 KF
MRFT 100 F	MRFUT 100 BF	MRFX 100 F	MRFR 100 KF
MRFT 150 F	MRFUT 150 BF	MRFX 150 F	MRFR 150 KF
MRFT225 F	MRFUT 225 BF	MRFX 225 F	MRFR 225 KF
MRFT 300 F	MRFUT 300 BF	MRFX 300 F	MRFR 300 KF
MRFT 450 F	MRFUT 450 BF	MRFX 450 F	MRFR 450 KF
MRFT 600 F	MRFUT 600 BF	MRFX 600 F	MRFR 600 KF
MRFT 750 F	MRFUT 750 BF	MRFX 750 F	MRFR 750 KF
MRFT 900 F	MRFUT 900 BF	MRFX 900 F	MRFR 900 KF

Key : selecting MRF medium duty fittings

Replace the letters shown in red with your choice from the following options :

A = Angle (°) : 60, 45 and 30 (90 standard and does not need to be included in order code)

B = Branch width (mm) : 50, 75, 100, 150, 225, 300, 450, 600, 750

F = Finish : **G** (hot dip galvanised after manufacture), **D** (deep galvanised steel), **PG** (pre-galvanised steel), **S** (stainless steel), **E** (powder coated black RAL 9005)

K = Narrowed width when using a reducer (mm) : 50, 75, 100, 150, 225, 300, 450, 600, 750

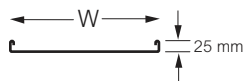

Inside riser. See p. 19

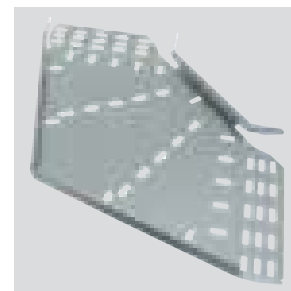

Flat bend. See p. 19

Swifts® SRF heavy duty and XRF extra heavy duty

cable tray systems

SRF HEAVY DUTY									
	TRAY		COUPLERS	FITTINGS					
	Widths (mm)	Straight lengths (3 m) F = finish	Coupler sets F = finish	Universal bracket F = finish	90° Flat bends ¹ F = finish	Adjustable bends F = finish	90° Inside risers ¹ F = finish	90° Outside risers ¹ F = finish	Adjustable risers ⁽²⁾ F = finish
SRF HEAVY DUTY									
	75	SRFL 75 F	SRFC F	SRFUB F	SRFB 75 F	SRFAB 75 F	SRFIR 75 F	SRFOR 75 F	SRFAR 75 F
	100	SRFL 100 F	SRFC F	SRFUB F	SRFB 100 F	SRFAB 100 F	SRFIR 100 F	SRFOR 100 F	SRFAR 100 F
	150	SRFL 150 F	SRFC F	SRFUB F	SRFB 150 F	SRFAB 150 F	SRFIR 150 F	SRFOR 150 F	SRFAR 150 F
	225	SRFL 225 F	SRFC F	SRFUB F	SRFB 225 F	SRFAB 225 F	SRFIR 225 F	SRFOR 225 F	SRFAR 225 F
	300	SRFL 300 F	SRFC F	SRFUB F	SRFB 300 F	SRFAB 300 F	SRFIR 300 F	SRFOR 300 F	SRFAR 300 F
	450	SRFL 450 F	SRFC F	SRFUB F	SRFB 450 F		SRFIR 450 F	SRFOR 450 F	SRFAR 450 F
	600	SRFL 600 F	SRFC F	SRFUB F	SRFB 600 F	–	SRFIR 600 F	SRFOR 600 F	SRFAR 600 F
	750	SRFL 750 F	SRFC F	SRFUB F	SRFB 750 F	–	SRFIR 750 F	SRFOR 750 F	SRFAR 750 F
900	SRFL 900 F	SRFC F	SRFUB F	SRFB 900 F	–	SRFIR 900 F	SRFOR 900 F	SRFAR 900 F	

(1) 60°, 45° and 30° angles need to have angle included in order code, ie. SRFB 300 60 G

(2) Extra long adjustable risers also available. Code as adjustable riser and insert X. Example : SRFAXR W F (p. 21)

XRF EXTRA HEAVY DUTY									
	TRAY		COUPLERS	FITTINGS					
	Widths (mm)	Straight lengths (3 m) F = finish	Coupler sets F = finish	Universal bracket F = finish	90° Flat bends ¹ F = finish	Adjustable bends F = finish	90° Inside risers ¹ F = finish	90° Outside risers ¹ F = finish	Adjustable risers F = finish
XRF EXTRA HEAVY DUTY				No universal brackets are available on XRF extra heavy duty		No adjustable bends are available on XRF extra heavy duty			No adjustable risers are available on XRF extra heavy duty
	100	XRFL 100 F	XRFC F	–	XRFB 100 F	–	XRIFIR 100 F	XRIFOR 100 F	–
	150	XRFL 150 F	XRFC F	–	XRFB 150 F	–	XRIFIR 150 F	XRIFOR 150 F	–
	225	XRFL 225 F	XRFC F	–	XRFB 225 F	–	XRIFIR 225 F	XRIFOR 225 F	–
	300	XRFL 300 F	XRFC F	–	XRFB 300 F	–	XRIFIR 300 F	XRIFOR 300 F	–
	450	XRFL 450 F	XRFC F	–	XRFB 450 F	–	XRIFIR 450 F	XRIFOR 450 F	–
600	XRFL 600 F	XRFC F	–	XRFB 600 F	–	XRIFIR 600 F	XRIFOR 600 F	–	

1 : 60°, 45° and 30° angles need to have angle included in order code, ie. XRFB 300 60 G

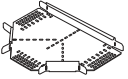
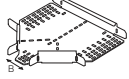
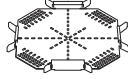
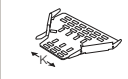
FITTINGS			
Equal tees F = finish 	Unequal tees B = branch F = finish 	4 way crosspieces F = finish 	Straight reducers K = reduced width F = finish 
SRFT 75 F	SRFUT 75 BF	SRFX 75 F	-
SRFT 100 F	SRFUT 100 BF	SRFX 100 F	SRFR 100 KF
SRFT 150 F	SRFUT 150 BF	SRFX 150 F	SRFR 150 KF
SRFT 225 F	SRFUT 225 BF	SRFX 225 F	SRFR 225 KF
SRFT 300 F	SRFUT 300 BF	SRFX 300 F	SRFR 300 KF
SRFT 450 F	SRFUT 450 BF	SRFX 450 F	SRFR 450 KF
SRFT 600 F	SRFUT 600 BF	SRFX 600 F	SRFR 600 KF
SRFT 750 F	SRFUT 750 BF	SRFX 750 F	SRFR 750 KF
SRFT 900 F	SRFUT 900 BF	SRFX 900 F	SRFR 900 KF

Key : selecting SRF heavy duty fittings

Replace the letters shown in red with your choice from the following options :
A = Angle (°) : 60, 45 and 30 (90 standard and does not need to be included in order code)

B = Branch width (mm) : 75, 100, 150, 225, 300, 450, 600, 750, 900

F = Finish : **G** (hot dip galvanised after manufacture), **D** (deep galvanised steel), **PG** (pre-galvanised steel), **S** (stainless steel), **E** (powder coated black RAL 9005)

K = Narrowed width when using a reducer (mm) :
 75, 100, 150, 225, 300, 450, 600, 750

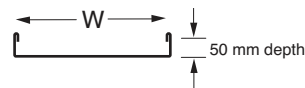

Inside riser. See p. 21

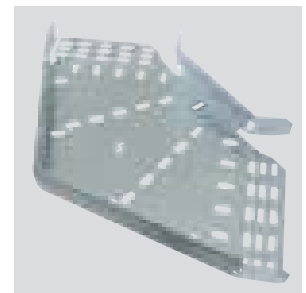

Flat bend. See p. 21

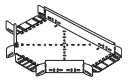
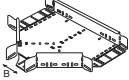
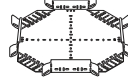
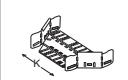
FITTINGS			
Equal tees F = finish 	Unequal tees B = branch F = finish 	4 way crosspieces F = finish 	Straight reducers K = reduced width F = finish 
XRFT 100 F	XRFUT 100 BF	XRFX 100 F	-
XRFT 150 F	XRFUT 150 BF	XRFX 150 F	XRFR 150 KF
XRFT 225 F	XRFUT 225 BF	XRFX 225 F	XRFR 225 KF
XRFT 300 F	XRFUT 300 BF	XRFX 300 F	XRFR 300 KF
XRFT 450 F	XRFUT 450 BF	XRFX 450 F	XRFR 450 KF
XRFT 600 F	XRFUT 600 BF	XRFX 600 F	XRFR 600 KF

Key : selecting XRF extra heavy duty fittings

Replace the letters shown in red with your choice from the following options :
A = Angle (°) : 60, 45 and 30 (90 standard and does not need to be included in order code)

B = Branch width (mm) : 100, 150, 225, 300, 450

F = Finish : **G** (hot dip galvanised after manufacture), **D** (deep galvanised steel), **S** (stainless steel)

K = Narrowed width when using a reducer (mm) : 100, 150, 225, 300, 450

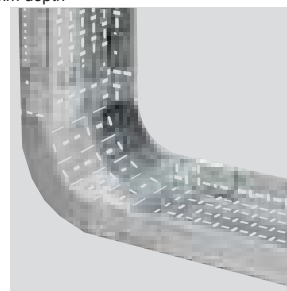
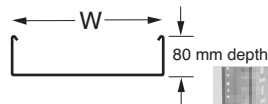

Inside riser, p. 23

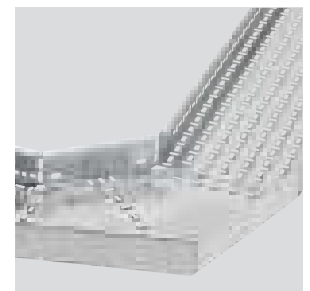

Flat bend, p. 22

Swifts® SS light duty cable tray

lengths and fittings

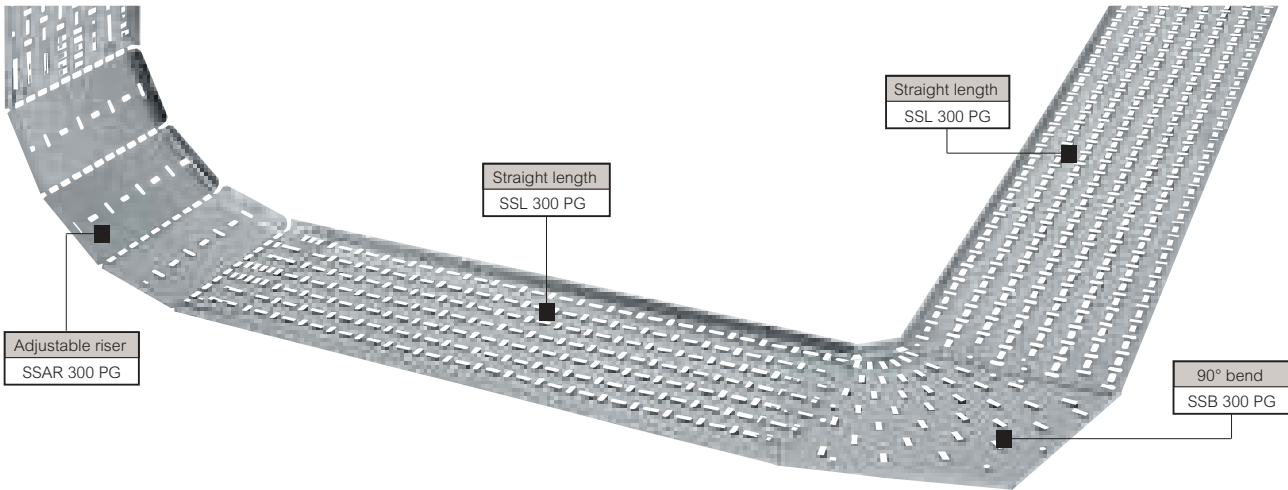
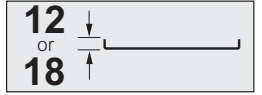

Selection charts **p. 12-13**
 Dimensions and technical information : lengths **p. 36** ; fittings **p. 38-45**
 Design notes **p. 118**
 Loading graphs **p. 36**

Pack	Cat. Nos.	Straight lengths – 3 m	
		All SS straight lengths and fittings have integral couplers, no separate couplers are needed For SS tray cut to length use fishplates across length-to-length joint, p. 24	
		Width (mm)	Depth (mm)
1	SSL 50 F	50	12
1	SSL 75 F	75	12
1	SSL 100 F	100	12
1	SSL 150 F	150	12
1	SSL 225 F	225	12
1	SSL 300 F	300	18
		For technical information, p. 36-37	

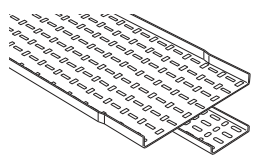

Pack	Cat. Nos.	Fittings
		All fittings have integral fishplates No couplers required
1	SSB W F	90° bends For technical information, p. 38-39
1	SSB W A F	60°, 45° and 30° bends For technical information, p. 38-39

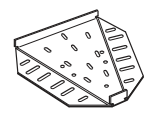
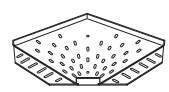

Pack	Cat. Nos.	Fittings (continued)
		Risers Inside and outside risers are not available in PG finish
1	SSIR W F	90° inside riser For technical information, p. 40-41
1	SSIR W A F	60°, 45° and 30° inside risers For technical information, p. 40-41

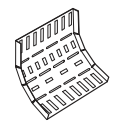
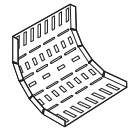

Additional gauges and finishes available to special order
 Contact us on +44 (0) 345 605 4333

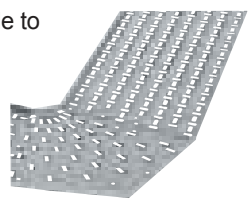

Key : selecting SS light duty fittings. Replace the letters shown in red with your choice from the following options :
W = Widths (mm) : 50, 75, 100, 150, 225, 300
A = Angle (°) : 60, 45 and 30 (90 does not need to be included in order code)
F = Finish : **G** (hot dip galvanised after manufacture)
PG (pre-galvanised), **S** (stainless steel)

Swifts® SS light duty cable tray

lengths and fittings (continued)

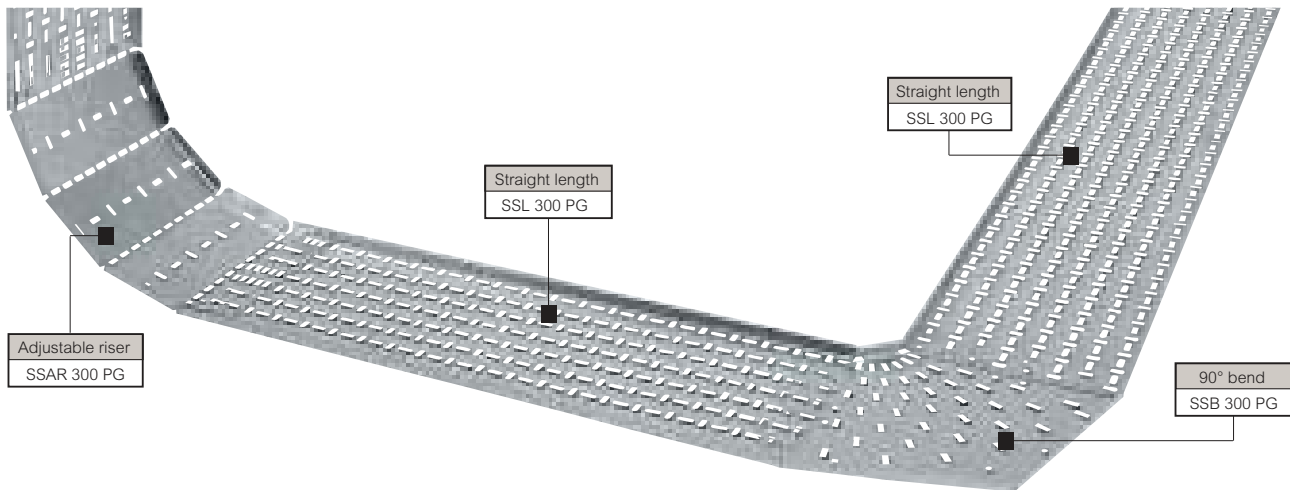

Selection charts **p. 12-13**
 Dimensions and technical information : lengths **p. 36** ; fittings **p. 38-45**
 Design notes **p. 118**
 Loading graphs **p. 36**

Pack	Cat. Nos.	Fittings (continued)
1	SSOR W F	90° outside risers For technical information, p. 40-41
1	SSOR W A F	60°, 45° and 30° outside risers For technical information, p. 40-41

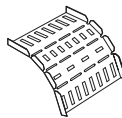
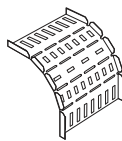

Pack	Cat. Nos.	Fittings (continued)
1	SSAR W F	Adjustable risers For technical information, p. 42
1	SST W F	Equal tees For technical information, p. 43
1	SSX W F	4 way crosspieces For technical information, p. 44
1	SSR W K F	Straight reducers For technical information, p. 45

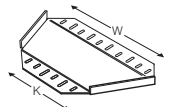
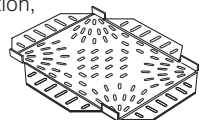
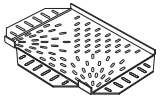
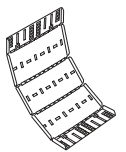

Additional gauges and finishes available to special order
Contact us on +44 (0) 345 605 4333

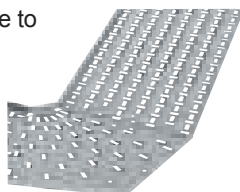

Key : selecting SS light duty fittings. Replace the letters shown in **red** with your choice from the following options :
W = Widths (mm) : 50, 75, 100, 150, 225, 300
A = Angle (°) : 60, 45 and 30 (90 does not need to be included in order code)
F = Finish : **G** (hot dip galvanised after manufacture)
PG (pre-galvanised), **S** (stainless steel)
K = Narrowed width when using a reducer (mm) : 50, 75, 100, 150, 225

Swifts® MRF medium duty return flange cable tray

lengths and couplers

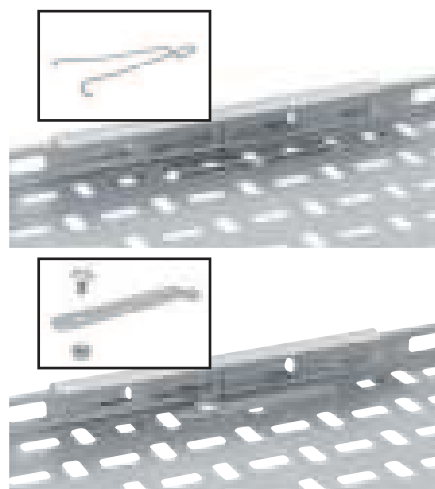
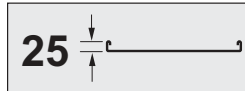

Selection charts **p. 12-13**
 Dimensions and technical information : lengths **p. 46** ; coupler sets and fixing options **p. 47-50** ; fittings **p. 51-63**
 Design notes **p. 118**
 Loading graphs **p. 46**

Pack	Cat. Nos.	Straight lengths – 3 m	
		Width (mm)	Depth (mm)
1	MRFL 50 F	50	25
1	MRFL 75 F	75	25
1	MRFL 100 F	100	25
1	MRFL 150 F	150	25
1	MRFL 225 F	225	25
1	MRFL 300 F	300	25
1	MRFL 450 F	450	25
1	MRFL 600 F	600	25
1	MRFL 750 F	750	25
1	MRFL 900 F	900	25

D finish is not available in 50 mm
 For technical information, **p. 46**

Pack	Cat. Nos.	Coupler sets
1	MRFC 50 F	Standard couplers For 50 mm wide tray
1	MRFC F	For 75-900 mm wide tray Supplied in pairs

Use to join straight lengths
 For technical information, **p. 47-50**

Pack	Cat. Nos.	Fixing options
100	QBF	All fixing options to be used with standard coupler sets shown opposite Quick bolt fasteners Pack of 100 M6 x 12 quick bolt fasteners with power tool nut driver Dacromet finish Stainless steel finish For technical information, p. 48
100	QBFS	
10	SCLPG	Swiftclip Two Swiftclips required per MRFC One Swiftclip required per MRFC50 Used to join straight lengths with MRFC and MRFC50 coupler sets Can also be used to join lengths to fittings For use with PG tray up to and including 300 mm wide For use with G tray up to and including 300 mm wide For technical information, p. 47-48, 50
10	SCLG	
10	SGR	Swiftgrip For use with standard couplers Length to length connections only Reduces number of fixings required from four per side to one For use on all widths from 50 mm to 900 mm Two Swiftgrips required per MRFC One Swiftgrip required per MRFC50 For use with PG and G tray For technical information, p. 47-48

Additional gauges and finishes available to special order
 Contact us on +44 (0) 345 605 4333

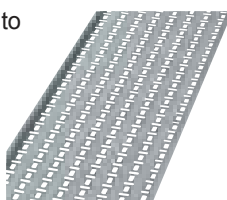

Key : selecting MRF medium duty lengths and couplers. Replace the letters shown in red with your choice from the following options :
F = Finish : **G** (hot dip galvanised after manufacture), **D** (deep galvanised), **PG** (pre-galvanised steel), **S** (stainless steel), **E** (powder coated black RAL 9005)

Swifts® MRF medium duty return flange cable tray

fittings

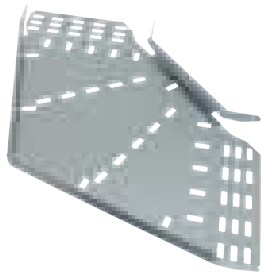
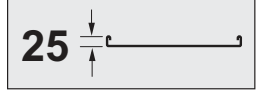

90° flat bend
MRFB 225 PG

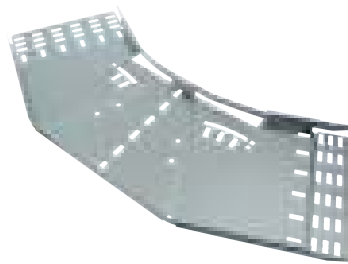

Adjustable bend
MRFAB 225 PG



Inside riser
MRFIR 225 PG

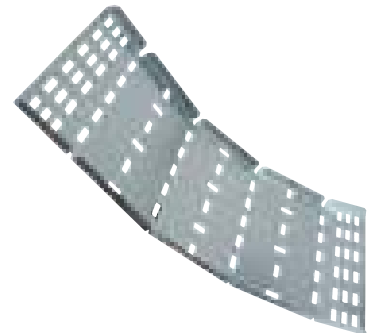

Adjustable riser
MRFAR 225 PG

Selection charts **p. 12-13**

Dimensions and technical information : lengths **p. 46** ; fixing options **p. 50** ; fittings **p. 51-63**

Design notes **p. 118**

Loading graphs **p. 46**



Pack	Cat. Nos.	Fittings (continued)
1	MRFB WF	All fittings have integral fishplates No couplers required 90° bends For technical information, p. 52-53
1	MRFB WAF	60°, 45° and 30° bends For 50-300 mm wide, adjustable bends can also be used For technical information, p. 52-53
1	MRFAB WF	Adjustable bends 50-300 mm wide only For technical information, p. 54-55
1	MRFIR WF	90° inside riser For technical information, p. 56
1	MRFIR WAF	60°, 45°, 30° inside riser For technical information, p. 56
1	MRFOR WF	90° outside riser For technical information, p. 56
1	MRFOR WAF	60°, 45°, 30° outside riser For technical information, p. 56

Pack	Cat. Nos.	Fittings (continued)
1	MRFAR WF	Adjustable risers (inside or outside) For technical information, p. 57
1	MRFAXR WF	Extra long adjustable risers (inside or outside) For technical information, p. 58
1	MRFT WF	Equal tees For technical information, p. 59
1	MRFT W B F	Unequal tees For technical information, p. 60-61
1	MRFX WF	4 way crosspieces For technical information, p. 62
1	MRFR W K F	Straight reducers For technical information, p. 63



Additional gauges and finishes available to special order

Contact us on +44 (0) 345 605 4333



Key : selecting MRF medium duty fittings. Replace the letters shown in red with your choice from the following options :

- W = Widths (mm) : 50, 75, 100, 150, 225, 300, 450, 600, 750, 900
- A = Angle (°) : 60, 45 and 30 (90 does not need to be included in order code)
- B = Branch width (mm) : 50, 75, 100, 150, 225, 300, 450, 600, 750
- F = Finish : G (hot dip galvanised after manufacture), D (deep galvanised), PG (pre-galvanised steel), S (stainless steel), E (powder coated black RAL 9005)
- K = Narrowed width when using a reducer (mm) : 50, 75, 100, 150, 225, 300, 450, 600, 750

Swifts® SRF heavy duty return flange cable tray

lengths and couplers

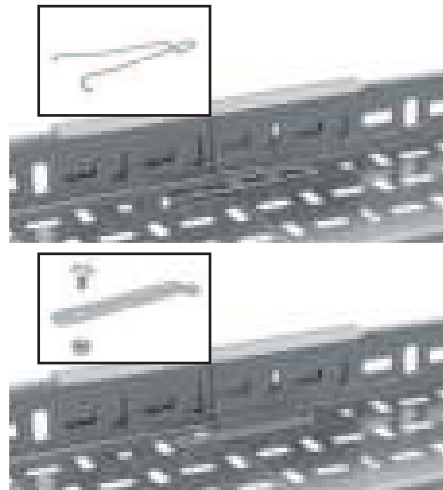
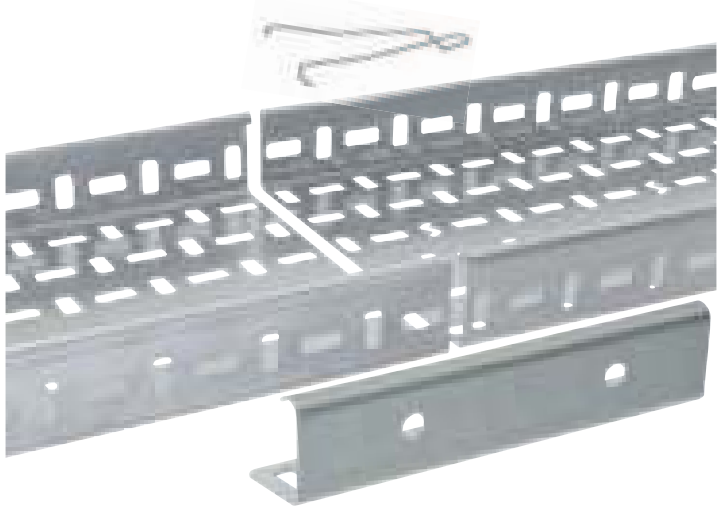
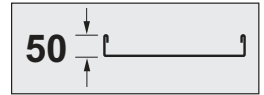

Selection charts **p. 14-15**
 Dimensions and technical information : lengths **p. 64** ; coupler sets and fixing options **p. 65-68** ; fittings **p. 69-83**
 Design notes **p. 118**
 Loading graphs **p. 64**

Pack	Cat. Nos.	Straight lengths – 3 m	
		Width (mm)	Depth (mm)
1	SRFL 75 F	75	50
1	SRFL 100 F	100	50
1	SRFL 150 F	150	50
1	SRFL 225 F	225	50
1	SRFL 300 F	300	50
1	SRFL 450 F	450	50
1	SRFL 600 F	600	50
1	SRFL 750 F	750	50
1	SRFL 900 F	900	50

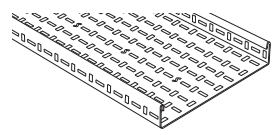

For technical information, **p. 64**

Pack	Cat. Nos.	Coupler sets
1	SRFC F	Use to join straight lengths Standard couplers Supplied in pairs For technical information, p. 65-68

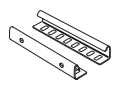

Pack	Cat. Nos.	Fixing options
		All fixing options to be used with standard coupler sets shown opposite
		Quick bolt fasteners Pack of 100 M6 x 12 quick bolt fasteners with power tool nut driver Dacromet finish Stainless steel finish For technical information, p. 66
100	QBF	
100	QBFS	
10	SCLPG	Swiftclip Two Swiftclips required per SRFC Used to join straight lengths with SRFC coupler sets Can also be used to join lengths to fittings
10	SCLG	For use with PG tray up to and including 300 mm wide For use with G tray up to and including 300 mm wide For technical information, p. 65-66, 68
		Swiftgrip For use with standard couplers Length to length connections only Reduces number of fixings required from four per side to one For use on all widths from 75 mm to 900 mm Two Swiftgrips required per SRFC
10	SGR	For use with PG and G tray For technical information, p. 65-66

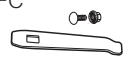

Additional gauges and finishes available to special order
 Contact us on +44 (0) 345 605 4333

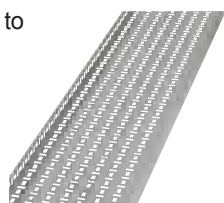

Key : selecting SRF heavy duty lengths and couplers. Replace the letters shown in red with your choice from the following options :
F = Finish : **G** (hot dip galvanised after manufacture),
D (deep galvanised), **PG** (pre-galvanised steel),
S (stainless steel), **E** (powder coated black RAL 9005)

Swifts® SRF heavy duty return flange cable tray

fittings

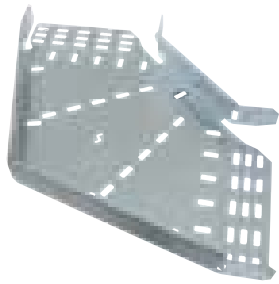
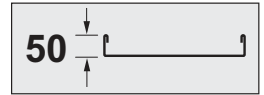

90° flat bend
SRFB 225 PG

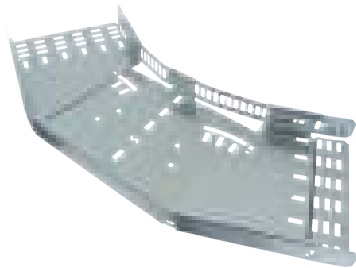

Adjustable bend
SRFAB 225 PG



Inside riser
SRFIR 225 PG

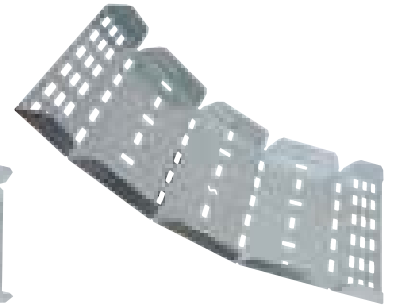

Adjustable riser
SRFAR 225 PG

Selection charts **p. 14-15**

Dimensions and technical information : lengths **p. 64** ; fixing options **p. 68** ; fittings **p. 69-83**

Design notes **p. 118**

Loading graphs **p. 64**



Pack	Cat. Nos.	Fittings
1	SRFB W F	All fittings have integral fishplates No couplers required 90° bends For technical information, p. 70-71
1	SRFB W A F	60°, 45° and 30° bends For 75 - 300 mm wide, adjustable bends can also be used For technical information, p. 70-71
1	SRFAB W F	Adjustable bends 75 - 300mm wide only For technical information, p. 72-73
1	SRFIR W F	90° inside riser For technical information, p. 74
1	SRFIR W A F	60°, 45°, 30° inside riser For technical information, p. 74
1	SRFOR W F	90° outside riser For technical information, p. 74
1	SRFOR W A F	60°, 45°, 30° outside riser For technical information, p. 74

Pack	Cat. Nos.	Fittings (continued)
1	SRFAR W F	Adjustable risers (inside or outside) For technical information, p. 75
1	SRFAXR W F	Extra long adjustable risers (inside or outside) For technical information, p. 76
1	SRFT W F	Equal tees For technical information, p. 77
1	SRFUT W B F	Unequal tees For technical information, p. 78-79
1	SRFX W F	4 way crosspieces For technical information, p. 80
1	SRFR W K F	Straight reducers For technical information, p. 81
1	SRFMRFR W F	SRF to MRF straight reducers For technical information, p. 82



Additional gauges and finishes available to special order

Contact us on +44 (0) 345 605 4333

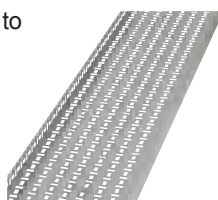

Key : selecting SRF heavy duty fittings. Replace the letters shown in red with your choice from the following options :

W = Widths (mm) : 75, 100, 150, 225, 300, 450, 600, 750, 900

A = Angle (°) : 60, 45 and 30 (90 does not need to be included in order code)

B = Branch width (mm) : 75, 100, 150, 225, 300, 450, 600, 750

F = Finish : **G** (hot dip galvanised after manufacture),

D (deep galvanised), **PG** (pre-galvanised steel),

S (stainless steel), **E** (powder coated black RAL 9005)

K = Narrowed width when using a reducer (mm) :

75, 100, 150, 225, 300, 450, 600, 750

Swifts® XRF extra heavy duty return flange cable tray

lengths and fittings

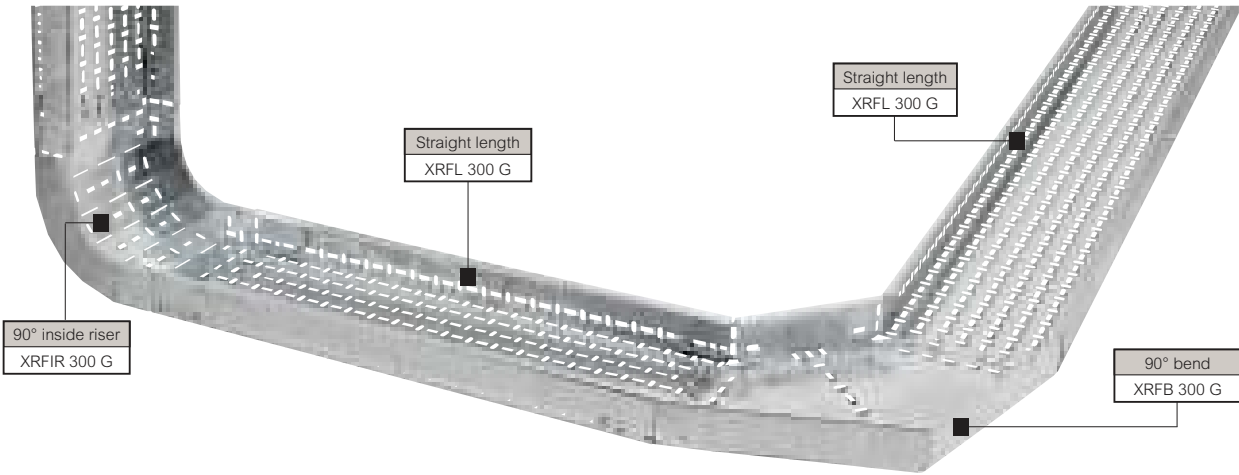
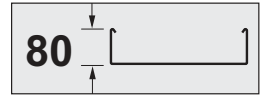

Selection charts **p. 14-15**
 Dimensions and technical information : lengths **p. 84** ; coupler sets **p. 85** ; fittings **p. 86-93**
 Design notes **p. 118**
 Loading graphs **p. 84**

Pack	Cat. Nos.	Straight lengths – 3 m	
		Width (mm)	Depth (mm)
1	XRFL 100 F	100	80
1	XRFL 150 F	150	80
1	XRFL 225 F	225	80
1	XRFL 300 F	300	80
1	XRFL 450 F	450	80
1	XRFL 600 F	600	80

For technical information, **p. 84**

1	XRFC F	Coupler sets Use to join straight lengths Supplied in pairs For technical information, p. 85
---	---------------	--

Pack	Cat. Nos.	Fittings
1	XRFB WF	All fittings have integral fishplates No couplers required 90° bends For technical information, p. 86-87
1	XRFB WAF	60°, 45° and 30° bends For technical information, p. 86-87

Additional gauges and finishes available to special order
Contact us on +44 (0) 345 605 4333

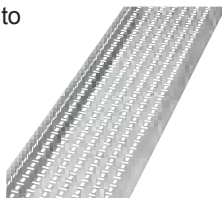

Key : selecting XRF extra heavy duty fittings. Replace the letters shown in red with your choice from the following options :
W = Widths (mm) : 100, 150, 225, 300, 450, 600
A = Angle (°) : 60, 45 and 30 (90 does not need to be included in order code)
F = Finish : **G** (hot dip galvanised after manufacture), **D** (deep galvanised), **S** (stainless steel)

Swifts® XRF extra heavy duty return flange cable tray

lengths and fittings (continued)

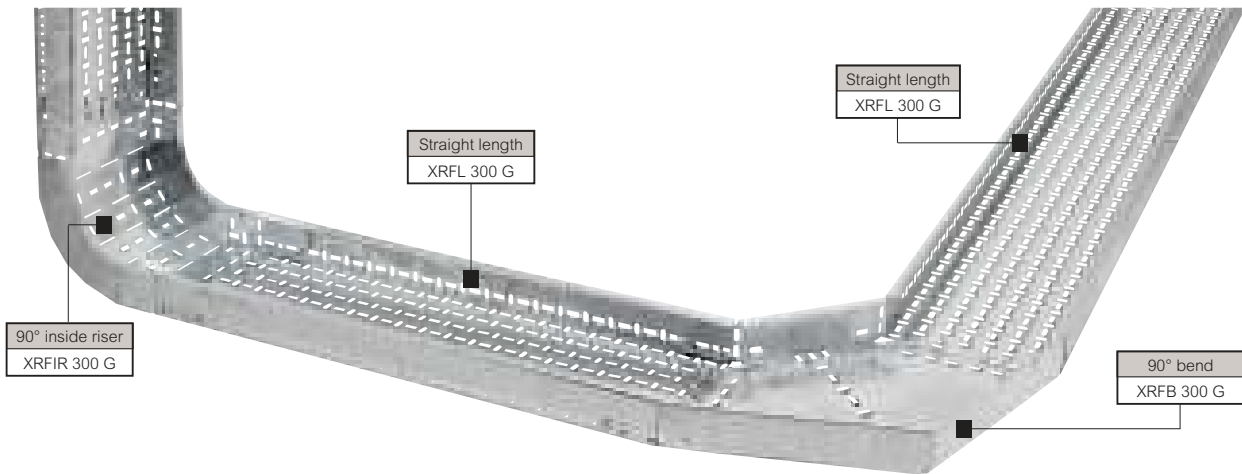
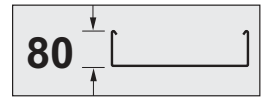

Selection charts **p. 14-15**

Dimensions and technical information : lengths **p. 84** ; coupler sets **p. 85** ; fittings **p. 86-93**

Design notes **p. 118**

Loading graphs **p. 84**



Pack	Cat. Nos.	Fittings (continued)
1	XR FIR WF	All fittings have integral fishplates No couplers required 90° inside riser For technical information, p. 88-89
1	XR FIR W A F	60°, 45° and 30° inside riser For technical information, p. 88-89
1	XR FOR WF	90° outside riser For technical information, p. 88-89
1	XR FOR W A F	60°, 45° and 30° outside riser For technical information, p. 88-89

Pack	Cat. Nos.	Fittings (continued)
1	XR T WF	Equal tees For technical information, p. 90
1	XR FUT W B F	Unequal tees For technical information, p. 91
1	XR FX WF	4 way crosspieces For technical information, p. 92
1	XR FR W K F	Straight reducers For technical information, p. 93



Additional gauges and finishes available to special order

Contact us on +44 (0) 345 605 4333

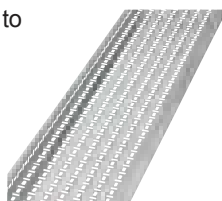

Key : selecting XRF extra heavy duty fittings. Replace the letters shown in red with your choice from the following options :

- W = Widths (mm) : 100, 150, 225, 300, 450, 600
- A = Angle (°) : 60, 45 and 30 (90 does not need to be included in order code)
- B = Branch width (mm) : 100, 150, 225, 300, 450
- F = Finish : G (hot dip galvanised after manufacture), D (deep galvanised), S (stainless steel)
- K = Narrowed width when using a reducer (mm) : 100, 150, 225, 300, 450

Swifts® cable tray fittings

SS light duty, MRF medium duty, SRF heavy duty, XRF extra heavy duty

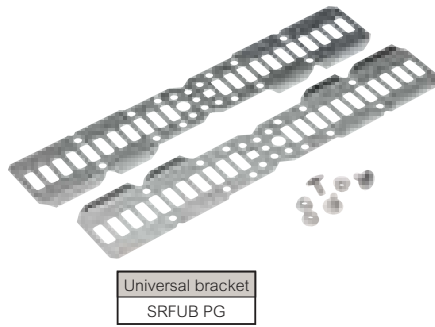
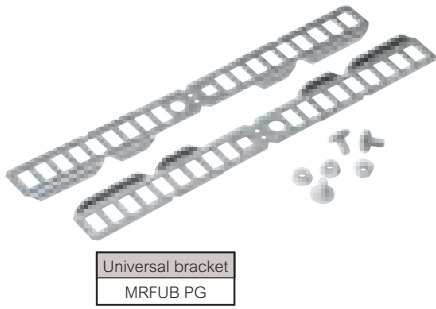

Dimensions and technical information p. 51, 69, 105

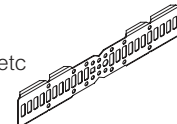
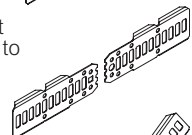
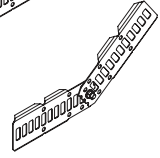
Pack	Cat. Nos.	Fittings
		<p>Universal brackets and fishplates are used for on-site fabrication of fittings</p> <p>Universal bracket Universal brackets can be used in a number of ways to achieve many change of direction and reducing functions. Brackets can be folded into shape using a pair of pliers to create bends, tees, 4 way crosspieces etc</p>  <p>Over fold to split bracket and join using fasteners to create hinged couplers</p>  
5	MRFUB F	For MRF tray
5	SRFUB F	For SRF tray Supplied in packs containing 5 pairs of brackets, 100 quick bolt fasteners, and power tool nut driver Available in PG, G and S finishes For technical information, p. 51, 69

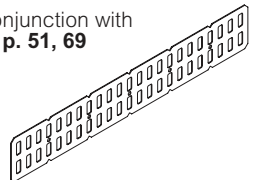
Pack	Cat. Nos.	Fittings (continued)
		<p>Universal fishplates Fishplates are designed for extra strength when joining cable tray beds. They can also help to protect cables from cut edges. The universal fishplate can be overfolded and split at 75 mm centres when working with narrow trays. Can be used in conjunction with universal bracket, p. 51, 69. Available in PG, G and S finishes</p> 
1	UF450 F	
		<p>Fishplates Fishplates are designed for extra strength when joining cable tray beds. Supplied singly without fasteners. To select correct fishplate, refer to table p. 105</p>
1	F F	For SS and XRF
1	MF F	For XRF
1	WF F	For SS, MRF, SRF and XRF For technical information, p. 105

Key : selecting fittings. Replace the letters shown in red with your choice from the following options :

F = Finish : **G** (hot dip galvanised after manufacture), **D** (deep galvanised), **PG** (pre-galvanised), **S** (stainless steel)

Swifts® cable tray supports

SS light duty, MRF medium duty, SRF heavy duty, XRF extra heavy duty

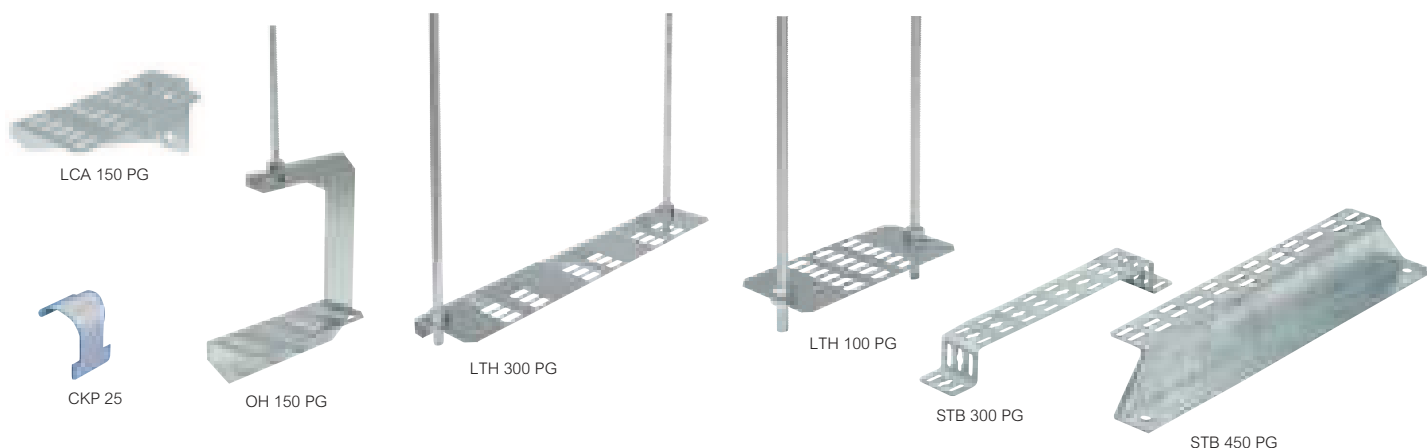

Dimensions and technical information p. 94-98

Pack	Cat. Nos.	Supports
		Cantilever arms Supplied singly without fasteners Fit horizontal runs of tray to flat surfaces and Swiftrack channel. Suitable for all tray widths For technical information, p. 94-95
1 1	LCA 50 F LCA 75 F	50 mm 75 mm
1 1	LCA 100 F LCA 150 F	100 mm 150 mm
1 1	LCA 225 F LCA 300 F	225 mm 300 mm
1 1 1 1	LCA 450 F LCA 600 F LCA 750 F LCA 900 F	450 mm 600 mm 750 mm 900 mm
50 50	CKP 25 CKP 50	Easi-clip Used to connect tray to Swiftrack channel Zinc coated finish For MRF tray For SRF tray
1 1 1 1	OH 50 F OH 75 F OH 100 F OH 150 F	Overhead hangers Supplied singly without fasteners Support horizontal runs of lightly loaded tray up to 150 mm wide from overhead structures Use M10 threaded rod For technical information, p. 96

Pack	Cat. Nos.	Supports (continued)
		Trapeze hangers Supplied singly without fasteners Support horizontal runs of tray from overhead structures Up to 450 mm wide use M10 threaded rods. For 600 mm wide and above use M12 threaded rods For technical information, p. 97
1 1 1	LTH 50 F LTH 75 F LTH 100 F	50 mm 75 mm 100 mm
1 1 1 1	LTH 150 F LTH 225 F LTH 300 F LTH 450 F	150 mm 225 mm 300 mm 450 mm
1 1 1	LTH 600 F LTH 750 F LTH 900 F	600 mm 750 mm 900 mm
1 1 1 1 1	STB 50 F STB 75 F STB 100 F STB 150 F STB 225 F STB 300 F	Stand-off brackets Supplied singly without fasteners Fit vertical or horizontal runs of tray to vertical surfaces, floors and Swiftrack channel For technical information, p. 98
1 1 1 1	STB 450 F STB 600 F STB 750 F STB 900 F	50 mm 75 mm 100 mm 150 mm 225 mm 300 mm

Key : selecting supports. Replace the letters shown in red with your choice from the following options :
F = Finish : **G** (hot dip galvanised after manufacture), **D** (deep galvanised), **PG** (pre-galvanised)
S (stainless steel), **E** (powder coated black RAL 9005)

Swifts® cable tray ancillary items / covers

SS light duty, MRF medium duty, SRF heavy duty, XRF extra heavy duty

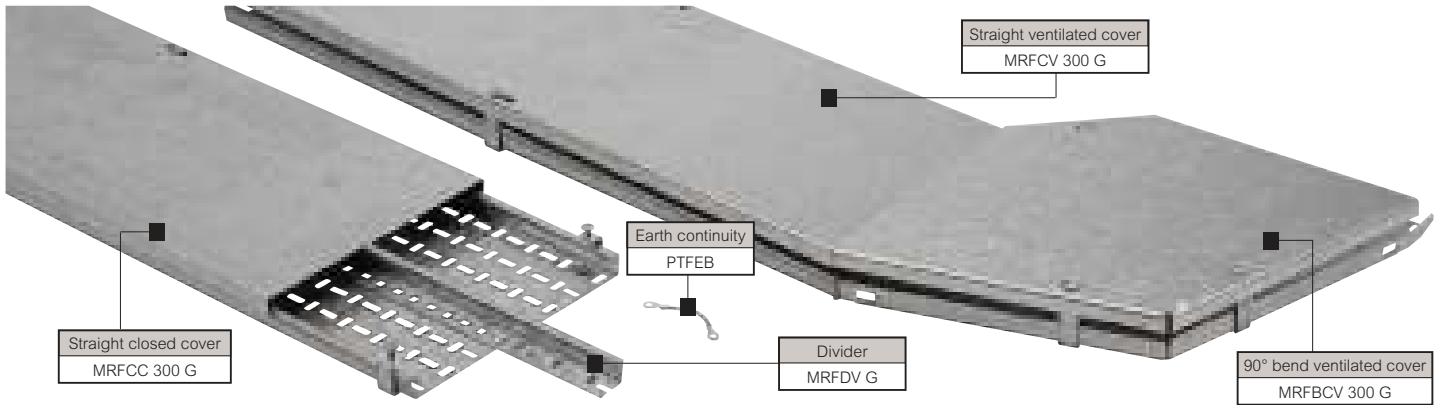

Dimensions and technical information p. 99-104

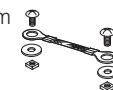
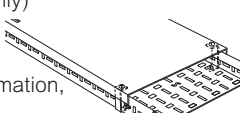
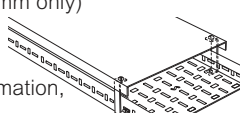
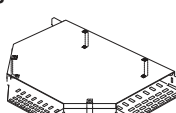
Pack	Cat. Nos.	Ancillary items
1	SSDV F	Dividers – 3 m Supplied singly without fasteners Used to separate different types or groups of cable within one cable tray run 
1	MRFDV F	
1	SRFDV F	
1	XRFDV F	
20	PTFEB	Earth continuity connectors Fasteners not included Use M6 x 12 mm roofing nuts and bolts Copper braid and copper lugs both in electroplated finish Length between centres : 93 mm Conductor area : 4 mm ²  For technical information, p. 99
1	SSCC W F	Straight closed covers – 3 m Supplied singly with fasteners and brackets 
1	MRFCV W F	
1	SRFCV W F	
1	XRFCV W F	
1	SSCV W F	Straight ventilated covers – 3 m Supplied singly with fasteners and brackets 
1	MRFCV W F	
1	SRFCV W F	
1	XRFCV W F	
1	SS -	Closed covers for fittings Supplied singly with fasteners and brackets Add CC before the width of your completed fitting Cat. No. Examples shown are for a 300 mm equal tee, hot dip galvanised 
1	MRF -	
1	SRF -	
1	XRF -	

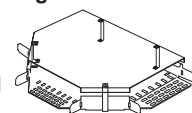
Pack	Cat. Nos.	Ancillary items (continued)
1	SS -	Ventilated covers for fittings Supplied singly with fasteners and brackets Add CV before the width of your completed fitting Cat. No. Examples shown are for a 300 mm equal tee, hot dip galvanised 
1	MRF -	
1	SRF -	
1	XRF -	

Key : selecting ancillary items. Replace the letters shown in red with your choice from the following options :

W = Widths (mm) : 50, 75, 100, 150, 225, 300, 450, 600, 750, 900
F = Finish : **G** (hot dip galvanised after manufacture), **D** (deep galvanised), **PG** (pre-galvanised)
S (stainless steel), **E** (powder coated black RAL 9005)

Swifts® cable tray fasteners

SS light duty, MRF medium duty, SRF heavy duty, XRF extra heavy duty



QBF



RB0620

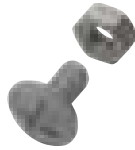

RBGO612



RB0620 S









TR08

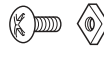
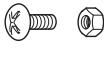

RC08

RWG06

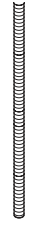
Pack	Cat. Nos.	Fasteners
100	QBF	Quick bolt fasteners Pack of 100 M6 x 12 quick bolt fasteners with power tool nut driver Dacromet finish Stainless steel finish For technical information, p. 48 
100	QBFS	
200	RB0612	Roofing nuts and bolts M6 x 12 electroplated zinc M6 x 16 electroplated zinc M6 x 20 electroplated zinc M6 x 25 electroplated zinc M6 x 30 electroplated zinc M6 x 40 electroplated zinc M6 x 50 electroplated zinc 
200	RB0616	
200	RB0620	
200	RB0625	
100	RB0630	
100	RB0640	
100	RB0650	
100	RBG0612	M6 x 12 hot dip galvanised 
100	RBG0616	
100	RB0612 S	M6 x 12 stainless steel 
100	RB0616 S	
100	RB0620 S	
500	RWG06	Roofing washers M6 hot dip galvanised 
400	TW06	Tray washers M6 x 20 electroplated zinc 
100	TWG06	

Pack	Cat. Nos.	Fasteners (continued)
1	TR06	Threaded rods M6 x 3 m electroplated zinc M8 x 3 m electroplated zinc M10 x 3 m electroplated zinc M12 x 3 m electroplated zinc 
1	TR08	
1	TR10	
1	TR12	
1	RC06	Threaded rod connectors M6 electroplated zinc M8 electroplated zinc M10 electroplated zinc M12 electroplated zinc 
1	RC08	
1	RC10	
1	RC12	

Swiftrack channel support system

channels and channel nuts



Typical applications **p. 138-139**
 Dimensions and technical information **p. 106-107**
 Design notes **p. 118**

Channel and brackets are manufactured to BS 6946 – specifications for metal channel cable support systems for electrical installations and calculations for loading are in accordance with BS 5950 : Part 5 1998 structural use of steelwork in buildings, code of practice for cold formed thin gauge sections

Pack	Cat. Nos.	Single channels - plain
		The standard finish for channel is pre-galvanised mild steel to BS EN 10346 For other finishes add the appropriate suffix G = hot dip galvanised after manufacture to BS EN ISO 1461 S = stainless steel to BS EN 10088 2 grade 1.4404 (equivalent to S316L31) Channels SC210 and SC410 are not available in S finish Examples : SC200 3M G for hot dip galvanised SC400 3M S for stainless steel For technical information, p. 106
1	SC200 3M	Standard channel 41 x 21 mm, 3 m length
1	SC200 6M	41 x 21 mm, 6 m length
1	SC400 3M	Standard channel 41 x 41 mm, 3 m length
1	SC400 6M	41 x 41 mm, 6 m length
1	SC210 3M	Light gauge channel 41 x 21 mm, 3 m length
1	SC410 3M	41 x 41 mm, 3 m length

Pack	Cat. Nos.	Back-to-back channel
		For technical information p. 107
1	SC401 3M	41 x 83 mm, 3 m length
1	SC401 6M	41 x 83 mm, 6 m length

Pack	Cat. Nos.	Single channels - slotted
		For technical information, p. 106
1	SC203 3M	Standard channel 41 x 21 mm, 3 m length
1	SC203 6M	41 x 21 mm, 6 m length
1	SC403 3M	Standard channel 41 x 41 mm, 3 m length
1	SC403 6M	41 x 41 mm, 6 m length
1	SC213 3M	Light gauge channel 41 x 21 mm, 3 m length
1	SC413 3M	41 x 41 mm, 3 m length

Pack	Cat. Nos.	Channel nuts
		For use with all channel M12 channel nuts should always be used for maximum load conditions The standard finish for all nuts is zinc plated to BS 3382 : Part 2 For stainless steel, add the suffix S Example : PN101S For hot dip galvanised, add the suffix G Example : PN101G Fasteners : Use hexagon head setscrews, p. 32 For technical information, p. 107

Pack	Cat. Nos.	Long springs
		For use with 41 mm deep channel
100	PN061	M6
100	PN081	M8
100	PN101	M10
100	PN121	M12

Pack	Cat. Nos.	Short springs
		For use with 21 mm deep channel
100	PN062	M6
100	PN082	M8
100	PN102	M10
100	PN122	M12

Pack	Cat. Nos.	No springs
		For use on all channel depths
100	PN060	M6
100	PN080	M8
100	PN100	M10
100	PN120	M12

Other fasteners and finishes available to special order
Contact us on +44 (0) 345 605 4333



Swiftrack channel support system

cantilever arms

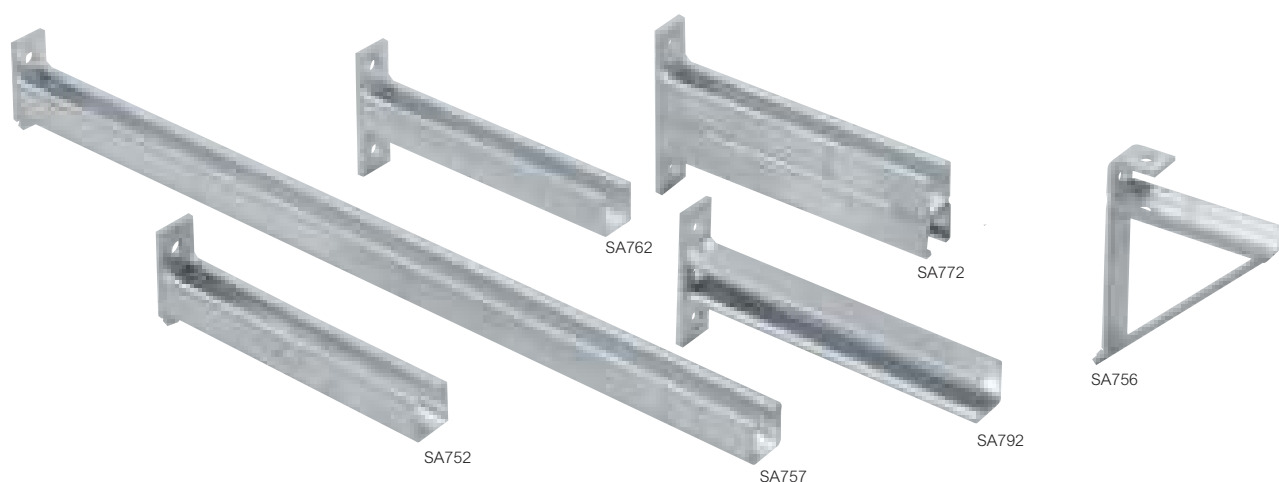

Dimensions and technical information **p. 108-109**

Pack	Cat. Nos.	Cantilever arms
		In addition to the cantilever arms listed, there are many other specialist support brackets for use with cable tray These are detailed in the relevant sections in this catalogue
		Cantilever arms Requires only one bolt for quick fixing and is used with open face at the top For technical information, p. 108
1	SA750	150 mm
1	SA751	225 mm
1	SA752	300 mm
1	SA753	450 mm
1	SA754	600 mm
1	SA755	750 mm
1	SA757	900 mm
		Cantilever arms, universal Two bolt fixing. Can be used with open face at the top or bottom For technical information, p. 108
1	SA760	150 mm
1	SA761	225 mm
1	SA762	300 mm
1	SA763	450 mm
1	SA764	600 mm
1	SA765	750 mm
1	SA766	900 mm
		Cantilever arms, side Two bolt fixing. Can be used with open face on the left or right For technical information, p. 108
1	SA790	150 mm
1	SA791	225 mm
1	SA792	300 mm
1	SA793	450 mm
1	SA794	600 mm
1	SA795	750 mm
1	SA796	900 mm

Pack	Cat. Nos.	Cantilever arms (continued)
		Cantilever arms, double channel Two bolt fixing with extra support Open face top and bottom For technical information, p. 108
1	SA770	150 mm
1	SA771	225 mm
1	SA772	300 mm
1	SA773	450 mm
1	SA774	600 mm
1	SA775	750 mm
1	SA776	900 mm
1	SA756	Cantilever arm bracket Used to provide extra support to a horizontal run of channel For technical information, p. 109
		Cantilever arms Used to support horizontal runs of tray on to a vertical length of channel For technical information, p. 94-95
1	LCA 50 F	50 mm
1	LCA 75 F	75 mm
1	LCA 100 F	100 mm
1	LCA 150 F	150 mm
1	LCA 225 F	225 mm
1	LCA 300 F	300 mm
1	LCA 450 F	450 mm
1	LCA 600 F	600 mm
1	LCA 750 F	750 mm
1	LCA 900 F	900 mm

Non-standard cantilever arms available to special order
Contact us on +44 (0) 345 605 4333

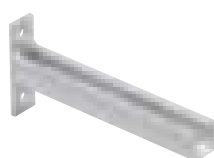



Key : Replace the letters shown in **red** with your choice from the following options :

F = Finish : **G** (hot dip galvanised after manufacture),
D (deep galvanised), **PG** (pre-galvanised steel),
S (stainless steel), **E** (powder coated black RAL 9005)

Swiftrack channel support system

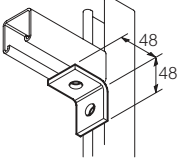
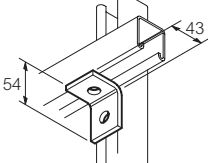
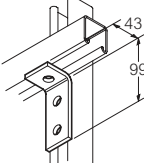
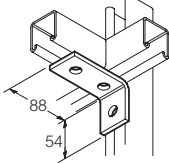
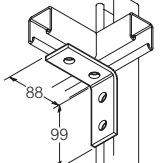
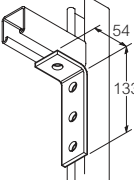
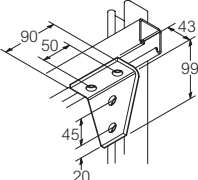
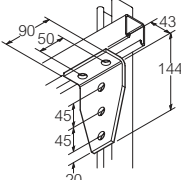
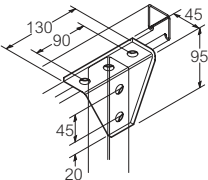
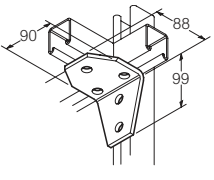
framework brackets

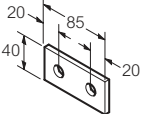
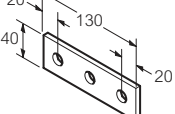
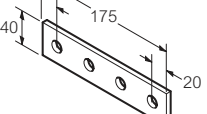
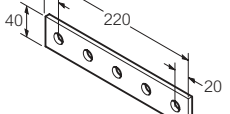
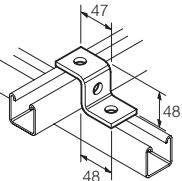
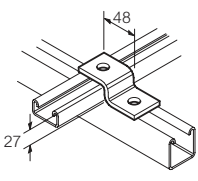
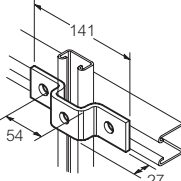
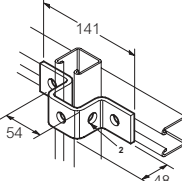
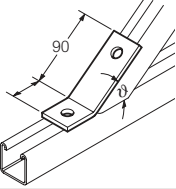
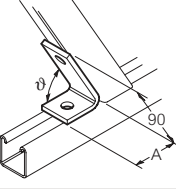
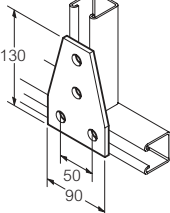
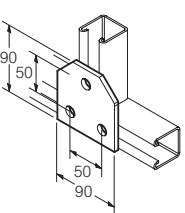
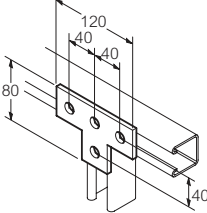
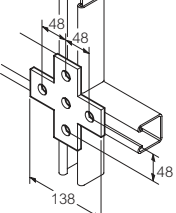
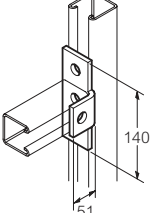
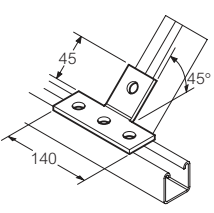
90° brackets					
					
Cat. No. SB500	Cat. No. SB501	Cat. No. SB502	Cat. No. SB503	Cat. No. SB504	
					
Cat. No. SB505	Cat. No. SB550	Cat. No. SB551	Cat. No. SB552	Cat. No. SB556	
Square and splice plates					
<p>Square plates</p>  <p>Cat. Nos. SB506 06 SB506 08 SB506 10 SB506 12</p> <p>Hole size M6 M8 M10 M12</p>	<p>Splice plate¹</p>  <p>Cat. No. SB507</p>	<p>Splice plate¹</p>  <p>Cat. No. SB508</p>	<p>Splice plate¹</p>  <p>Cat. No. SB509</p>	<p>Splice plate¹</p>  <p>Cat. No. SB510</p>	
Z brackets			U brackets		
					
Cat. No. SB511	Cat. No. SB513	Cat. No. SB514	Cat. No. SB515		
Angle brackets					
	<p>Obtuse angle brackets</p> <p>Cat. Nos. Angle</p> <p>SB520 15°</p> <p>SB524 45°</p> <p>SB526 60°</p> <p>SB528 75°</p>		<p>Acute angle brackets</p> <p>Cat. Nos. Angle</p> <p>SB532 45°</p> <p>SB534 60°</p> <p>SB536 75°</p>		
T plates and brackets					
					
Cat. No. SB554	Cat. No. SB555	Cat. No. SB603	Cat. No. SB603+	Cat. No. SB606 ³	Cat. No. SB607 ³

1 : Splice plates – holes spaced at 45 mm centres

2 : Hole on one side of bracket only

3 : SB606 and SB607 are not available in S (stainless steel) finish

Swiftrack channel support system

framework brackets (continued)

Joining brackets and channels			Base plates	
<p>Channel joining bracket</p> <p>Cat. No. SB518</p>	<p>Joining channel for SC200 channel</p> <p>Cat. No. SB650</p>	<p>Joining channel for SC400 channel</p> <p>Cat. No. SB651</p>	<p>Single channel base plate</p> <p>Cat. No. SB704</p>	<p>Double channel base plate</p> <p>Cat. No. SB705</p>
L brackets			Wing brackets	
<p>L bracket</p> <p>Cat. No. SB600</p>	<p>Right hand L corner bracket</p> <p>Cat. No. SB601²</p>	<p>Left hand L corner bracket</p> <p>Cat. No. SB602²</p>	<p>2 lug wing bracket</p> <p>Cat. No. SB700</p>	<p>3 lug wing bracket</p> <p>Cat. No. SB701</p>
			<p>Angled wing bracket</p> <p>Cat. No. SB707²</p>	
Gusseted brackets			Shelf brackets	
<p>Single channel gusseted bracket</p> <p>Cat. No. SB702</p>	<p>Double channel gusseted bracket</p> <p>Cat. No. SB706</p>		<p>Shelf brackets</p> <p>Cat. No. SB703</p>	
Beam, window beam and toe beam clamps				
<p>Beam clamp³</p> <p>Cat. No. SC850</p>	<p>Beam clamp³</p> <p>Cat. No. SC851</p>	<p>Window beam clamp³</p> <p>Cat. No. SC852/21</p>	<p>Window beam clamp³</p> <p>Cat. No. SC852/41</p>	<p>Beam clamp³</p> <p>Cat. No. SC852/82</p>
<p>Beam clamp³</p> <p>Cat. No. SC853</p>	<p>Beam clamp³</p> <p>Cat. No. SC854</p>	<p>Toe beam clamp³</p> <p>Cat. No. SC856⁴</p>	<p>Beam clamp³</p> <p>Cat. No. ZC1⁵</p>	<p>Beam clamp³</p> <p>Cat. No. FL2⁵</p>
				<p>Beam clamp³</p> <p>Cat. No. SC855</p>
Pipe clamps ⁶			Channel accessories	
<p>Cat. Nos. SP960 10-14 SP964 17-22 SP965 22-26 SP968 25-35 SP969 32-42 SP972 42-59 SP973 54-65</p>	<p>Cat. Nos. SP975 62-71 SP976 73-83</p>	<p>Channel end caps⁷</p> <p>Cat. Nos. SC950B SC950W</p>	<p>Channel end caps⁸</p> <p>Cat. Nos. SC951B SC951W</p>	<p>Closure strips</p> <p>Cat. Nos. SC952 SC953</p>

1 : Indicates inside dimensions 2 : SB601, SB602 and SB707 are not available in S (stainless steel) finish
3 : Beam clamps are supplied with nuts, bolts, cone point screws and U bolts where shown 4 : Requires 2 setscrews and channel nuts for fixing (not included)
5 : Stainless steel finish is not available 6 : All pipe clamps are available in pre-galvanised and stainless steel finishes
7 : For SC400, SC401 and SC403 channels 8 : For SC200, SC201 and SC203 channels

Swiftrack channel support systems

standard fixings and fasteners

Hexagon head setscrews			Cone point screws			Hexagon nuts			Electroplated roofing nuts and bolts			Hot dip galvanised roofing nuts and bolts								
Pack	Cat. Nos.	Size	Pack	Cat. Nos.	Size	Pack	Cat. Nos.	Size	Pack	Cat. Nos.	Size	Pack	Cat. Nos.	Size						
Hexagon head setscrews						Cone point screws														
ELECTROPLATED ZINC						ELECTROPLATED ZINC														
200	SS0616	M6 x 16	100	CP1035	M10 x 35															
200	SS0620	M6 x 20	STAINLESS STEEL																	
200	SS0625	M6 x 25	100	CP1035 S	M10 x 35															
200	SS0630	M6 x 30	Hexagon nuts																	
200	SS0820	M8 x 20	ELECTROPLATED ZINC																	
200	SS0825	M8 x 25	500	HN06	M6															
200	SS0830	M8 x 30	500	HN08	M8															
200	SS0835	M8 x 35	200	HN10	M10															
200	SS0840	M8 x 40	200	HN12	M12															
200	SS0850	M8 x 50	Roofing nuts and bolts																	
200	SS1016	M10 x 16	ELECTROPLATED ZINC																	
200	SS1020	M10 x 20	200	RB0612	M6 x 12															
200	SS1025	M10 x 25	200	RB0616	M6 x 16															
200	SS1030	M10 x 30	200	RB0620	M6 x 20															
100	SS1035	M10 x 35	200	RB0625	M6 x 25															
100	SS1040	M10 x 40	100	RB0630	M6 x 30															
100	SS1045	M10 x 45	100	RB0640	M6 x 40															
100	SS1050	M10 x 50	100	RB0650	M6 x 50															
100	SS1060	M10 x 60	HOT DIP GALVANISED																	
100	SS1220	M12 x 20	100	RBG0612	M6 x 12															
100	SS1225	M12 x 25	100	RBG0616	M6 x 16															
100	SS1230	M12 x 30	STAINLESS STEEL																	
100	SS1235	M12 x 35	100	RB0612 S	M6 x 12															
100	SS1240	M12 x 40	100	RB0616 S	M6 x 16															
100	SS1250	M12 x 50	100	RB0620 S	M6 x 20															
HOT DIP GALVANISED																				
200	SSG0612	M6 x 12																		
200	SSG0616	M6 x 16																		
200	SSG0620	M6 x 20																		
200	SSG0635	M6 x 35																		

Swiftrack channel support systems

standard fixings and fasteners (continued)

Flat washers	Roofing washers	Penny washers	Shakeproof washers	Tray washers	Threaded rods	Threaded rod connectors	Eye bolts
Pack	Cat. Nos.	Size		Pack	Cat. Nos.	Size	
Flat washers				Threaded rod			
ELECTROPLATED ZINC				ELECTROPLATED ZINC			
500	FW06	M6		3 m	TR06	M6 x 3 m	
500	FW08	M8		3 m	TR08	M8 x 3 m	
500	FW10	M10		3 m	TR10	M10 x 3 m	
200	FW12	M12		3 m	TR12	M12 x 3 m	
Roofing washers				Threaded rod connectors			
HOT DIP GALVANISED				ELECTROPLATED ZINC			
500	RWG06	M6		1	RC06	M6	
Penny washers				Eye bolts			
ELECTROPLATED ZINC				ELECTROPLATED ZINC			
400	PW06	M6 x 25		1	RC08	M8	
400	PW08	M8 x 25		1	RC10	M10	
400	PW10	M10 x 38		1	RC12	M12	
400	PW12	M12 x 40		1	EB06	M6 x 80	
Shakeproof washers				1			
ELECTROPLATED ZINC				EB08			
400	SW06	M6		1			
400	SW08	M8		EB10			
400	SW10	M10		M10 x 80			
400	SW12	M12		M10 x 80			
Tray washers							
ELECTROPLATED ZINC							
400	TW06	M6 x 20					
HOT DIP GALVANISED							
100	TWG06	M6 x 20					



tecnica specificati

TECHNICAL SPECIFICATIONS

SWIFTS CABLE TRAY SYSTEMS

SS LIGHT DUTY CABLE TRAY

Straight lengths and coupling detail	36-37
Flat bends	38-39
Inside, outside and adjustable risers	40-42
Equal tees	43
4 way crosspieces	44
Straight reducers	45

MRF MEDIUM DUTY RETURN FLANGE CABLE TRAY

Straight lengths	46
Couplers – straight length to straight length	47-49
Couplers – straight length to fitting	50
Universal brackets and fishplates	51
Flat and adjustable bends	52-55
Inside and outside risers	56
Adjustable and extra long adjustable risers	57-58
Equal and unequal tees	59-61
4 way crosspieces	62
Straight reducers	63

SRF HEAVY DUTY RETURN FLANGE CABLE TRAY

Straight lengths	64
Couplers – straight length to straight length	65-67
Couplers – straight length to fitting	68
Universal brackets and fishplates	69
Flat and adjustable bends	70-73
Inside and outside risers	74
Adjustable and extra long adjustable risers	75-76
Equal and unequal tees	77-79
4 way crosspieces	80
Straight reducers	81
SRF to MRF straight reducers	82
Handed reducers	83

XRF EXTRA HEAVY DUTY RETURN FLANGE CABLE TRAY

Straight lengths	84
Couplers sets	85
Flat bends	86-87
Inside and outside risers	88-89
Equal and unequal tees	90-91
4 way crosspieces	92
Straight reducers	93

Supports	94-98
Ancillary items and covers	99-105

SWIFTRACK CHANNEL SUPPORT SYSTEM

Single channels – plain and slotted	106
Back-to-back channels	107
Assembly – fasteners and channel nuts	107
Cantilever arms	108-109
Framework brackets	110-113
Beam clamps, pipe clamps and accessories	113-115

■ Dimensions and weights

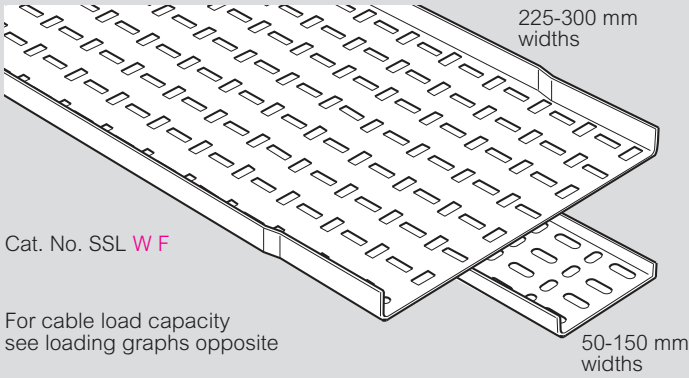

Dimensions

Standard length 3 m

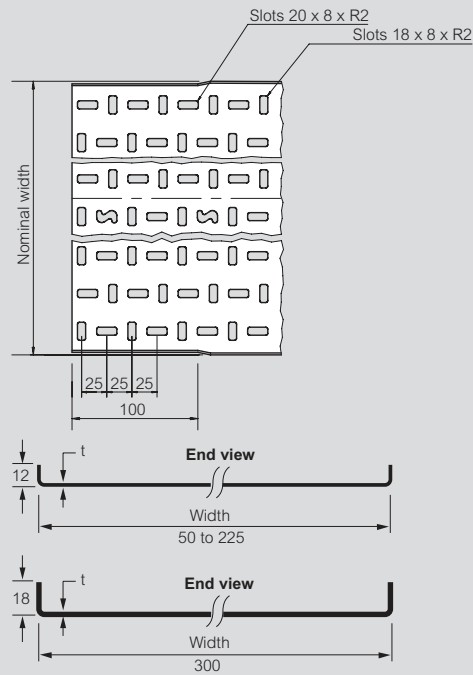

R = radius

Gauges and weights

The gauge 't' for each cable tray width and finish can vary by product and range

Non-standard gauges and finishes are available to special order, contact us on +44 (0) 345 605 4333

Cat. Nos.	Width (mm)	Weight (kg)	Gauge t (mm)
SSL50G	50	1.4	0.9
SSL50PG	50	1.2	0.9
SSL50S	50	1.7	1.2
SSL75G	75	1.8	0.9
SSL75PG	75	1.7	0.9
SSL75S	75	2.2	1.2
SSL100G	100	2.3	0.9
SSL100PG	100	2.1	0.9
SSL100S	100	2.9	1.2
SSL150G	150	3.3	0.9
SSL150PG	150	2.8	0.9
SSL150S	150	4.1	1.2
SSL225G	225	5.2	0.9
SSL225PG	225	4.8	0.9
SSL225S	225	7.4	1.5
SSL300G	300	10.4	1.5
SSL300PG	300	9.0	1.4
SSL300S	300	10.0	1.5

■ Loading graphs

Load tests carried out to BS EN 61537 and shown in kg/m

Cable fill figure is the maximum physical load of cables that can be fitted into tray and is based on 1700 kg/m³ as detailed in the BEAMA "Best Practice guide to cable ladder and cable tray systems"

The loads shown on all graphs are the safe recommended maximum loads that can be applied and must include wind, snow and any other external forces in addition to the cable load

The graph shows the maximum load for tray installed at a support spacing within its recommended range

50-300 mm width trays

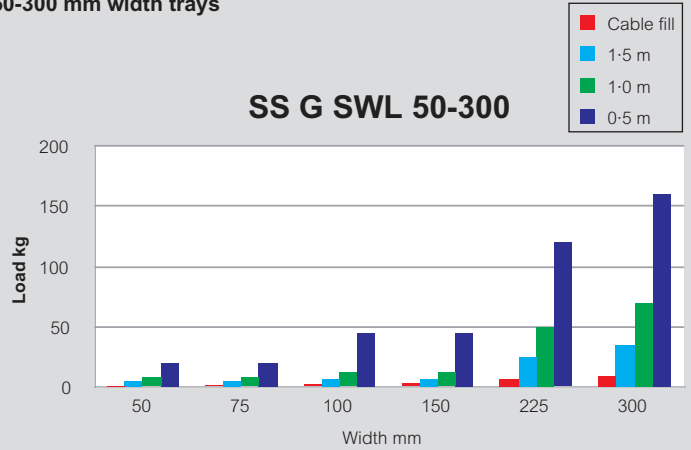

■ Finishes and standards

Standard stocked finish :

G Hot dip galvanised after manufacture to BS EN ISO 1461 : 2009

PG Pre-galvanised steel to BS EN 10346 : 2009 grade DX51D

Additional finishes :

S Stainless steel to BS EN 10088 – 2 grade 1.4404 (equivalent to 316L31)

Sheared steel (particularly stainless steel) does have relatively sharp edges and protective gloves must be worn during handling

All dimensions (mm) are nominal

Key : Replace the letter shown in red with your choice from the following options :

F = Finish : **G** (hot dip galvanised after manufacture), **PG** (pre-galvanised steel), **S** (stainless steel)

Fishplates : see p. 105

Swifts® SS light duty

straight lengths (continued)



■ Coupling detail

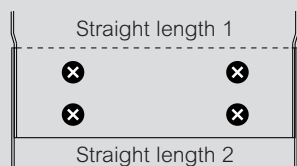

All SS straight lengths have one end joggled to allow jointing without a separate coupler, see illustration. Slide joggled end of length 1 inside length 2 before fastening.

Note

Quantity of bed fasteners
50 - 225 mm = 4, 300 mm = 6

Fasteners (not included)

For G and PG finish

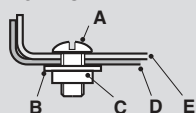

- A M6 x 12 roofing bolt
- B Roofing washer
- C M6 square nut
- D Straight length
- E Straight length
- F M6 x 12 panhead screw
- G M6 form A washer
- H M6 hexagon nut

For S finish

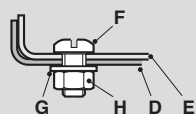

Fastener finishes

For flat bends with G and PG finishes, fasteners are galvanised or zinc plated. For flat bends with S finish, fasteners are stainless steel.

Key : Replace the letter shown in red with your choice from the following options :

F = Finish : **G** (hot dip galvanised after manufacture),
PG (pre-galvanised steel), **S** (stainless steel)

All dimensions (mm) are nominal

Swifts® SS light duty fittings

flat bends – 90°, 60°, 45° and 30°

12
or
18

■ 90° flat bends – dimensions and weights

Cat. No. SSB **W F**

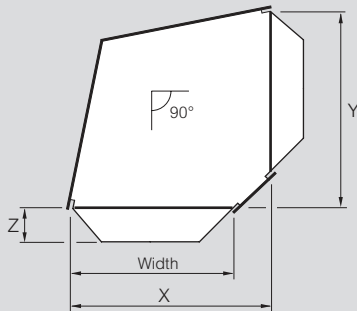

Cat. Nos.	Width	X	Y	Z	Weight (kg)
SSB 50 F	50	100	100	32	0.1
SSB 75 F	75	125	125	32	0.2
SSB 100 F	100	150	150	32	0.3
SSB 150 F	150	200	200	32	0.5
SSB 225 F	225	275	275	57	1.0
SSB 300 F	300	350	350	57	1.5

■ 60° flat bends – dimensions and weights

Cat. No. SSB **W 60 F**

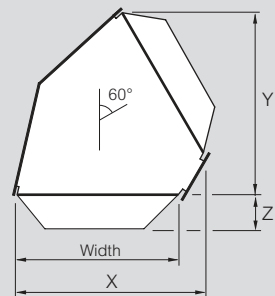

Cat. Nos.	Width	X	Y	Z	Weight (kg)
SSB 50 60 F	50	78	89	32	0.1
SSB 75 60 F	75	103	110	32	0.1
SSB 100 60 F	100	125	131	32	0.2
SSB 150 60 F	150	175	173	32	0.3
SSB 225 60 F	225	250	238	57	0.6
SSB 300 60 F	300	325	303	57	1.0

■ 45° flat bends – dimensions and weights

Cat. No. SSB **W 45 F**

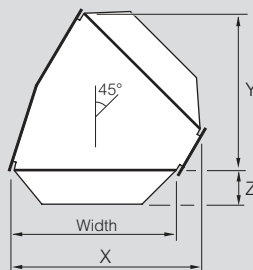

Cat. Nos.	Width	X	Y	Z	Weight (kg)
SSB 50 45 F	50	66	73	32	0.1
SSB 75 45 F	75	91	91	32	0.1
SSB 100 45 F	100	116	108	32	0.2
SSB 150 45 F	150	166	144	32	0.3
SSB 225 45 F	225	238	193	57	0.5
SSB 300 45 F	300	315	248	57	0.8

■ 30° flat bends – dimensions and weights

Cat. No. SSB **W 30 F**

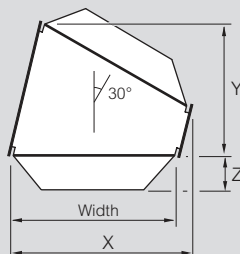

Cat. Nos.	Width	X	Y	Z	Weight (kg)
SSB 50 30 F	50	57	50	32	0.1
SSB 75 30 F	75	82	63	32	0.1
SSB 100 30 F	100	107	75	32	0.1
SSB 150 30 F	150	157	100	32	0.2
SSB 225 30 F	225	229	138	57	0.4
SSB 300 30 F	300	307	175	57	0.7

Key : Replace the letter shown in red with your choice from the following options :

F = Finish : **G** (hot dip galvanised after manufacture),
PG (pre-galvanised steel), **S** (stainless steel)

All dimensions (mm) are nominal

Swifts® SS light duty fittings

flat bends – 90°, 60°, 45° and 30° (continued)

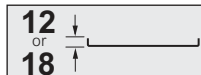

■ Dimensions and weights – flat bends 90°, 60°, 45° and 30°

Dimensions

X = Length of fitting from each end (excluding integral coupler)

Y = Length of fitting from each end (excluding integral coupler)

Z = End extension of integral coupler

Weights

All weights given are in kilograms (kg) and are for hot dip galvanised G finish

To obtain the appropriate component weight in other finishes, multiply the given weight by the following factors :

Stainless steel (S) x 0.94

Pre-galvanised (PG) x 0.96

■ Assembly – flat bends 90°, 60°, 45° and 30°

Coupling detail

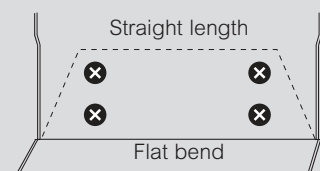

Note

Quantity of bed fasteners

50 - 225 mm = 4, 300 mm = 6

Fasteners (not included)

For G and PG finish

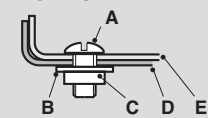

A M6 x 12 roofing bolt

B Roofing washer

C M6 square nut

D Fitting

E Straight length

For S finish

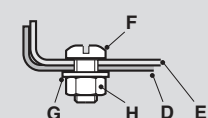

F M6 x 12 panhead screw

G M6 form A washer

H M6 hexagon nut

Fastener finishes

For flat bends with G and PG finishes, fasteners are galvanised or zinc plated. For flat bends with S finish, fasteners are stainless steel

■ Assembly – flat bends 90°, 60°, 45° and 30° (continued)

Minimum bend radius for cables – flat bends 90°

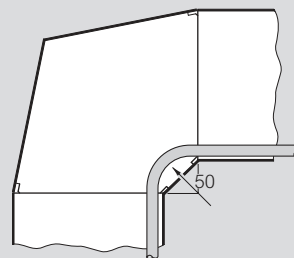

Minimum cable radius = 50 mm

Minimum bend radius for cables – flat bends 60°, 45° and 30°

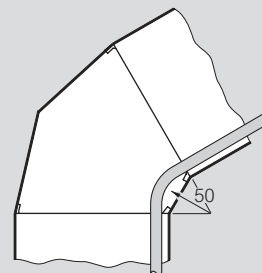

Minimum cable radius = 50 mm

Key : Replace the letter shown in red with your choice from the following options :

F = Finish : G (hot dip galvanised after manufacture),
PG (pre-galvanised steel), S (stainless steel)

All dimensions (mm) are nominal

90° inside and outside risers – dimensions and weights

90° inside riser

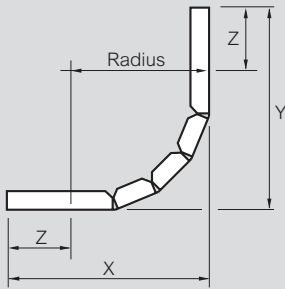

90° outside riser

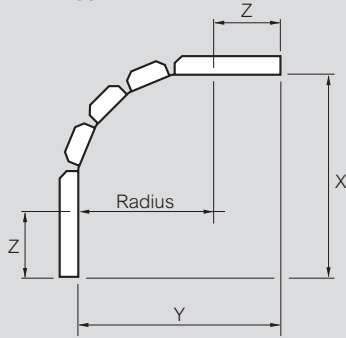

Cat. Nos.	Width	X	Y	Z'	Weight (kg)
SSIR 50 F	50	130	130	55	0.2
SSIR 75 F	75	130	130	55	0.2
SSIR 100 F	100	130	130	55	0.3
SSIR 150 F	150	130	130	55	0.4
SSIR 225 F	225	205	205	55	1.0
SSIR 300 F	300	205	205	55	1.3

1 : End extension measurement applies to both ends of the fitting
 Cat. Nos. given in the table are for inside risers. For outside risers substitute SIR for SIR
 Inside and outside risers are not available in PG finish
 For risers in PG finish use adjustable risers for all angles up to 90°, p. 42

60° inside and outside risers – dimensions and weights

60° inside riser

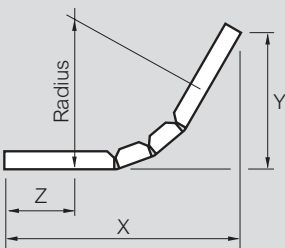

60° outside riser

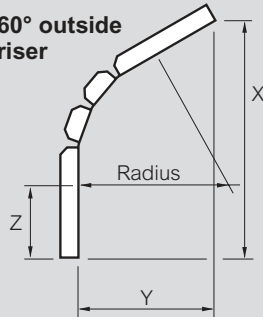

Cat. Nos.	Width	X	Y	Z'	Weight (kg)
SSIR 50 60 F	50	147	85	55	0.2
SSIR 75 60 F	75	147	85	55	0.2
SSIR 100 60 F	100	147	85	55	0.3
SSIR 150 60 F	150	147	85	55	0.4
SSIR 225 60 F	225	212	122	55	0.8
SSIR 300 60 F	300	212	122	55	1.0

1 : End extension measurement applies to both ends of the fitting
 Cat. Nos. given in the table are for inside risers. For outside risers substitute SIR for SIR
 Inside and outside risers are not available in PG finish
 For risers in PG finish use adjustable risers for all angles up to 90°, p. 42

45° inside and outside risers – dimensions and weights

45° inside riser

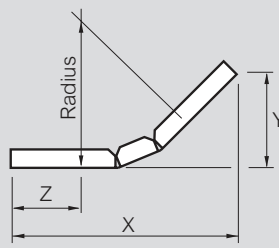

45° outside riser

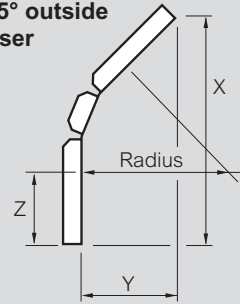

Cat. Nos.	Width	X	Y	Z'	Weight (kg)
SSIR 50 45 F	50	147	61	55	0.1
SSIR 75 45 F	75	147	61	55	0.2
SSIR 100 45 F	100	147	61	55	0.2
SSIR 150 45 F	150	147	61	55	0.3
SSIR 225 45 F	225	200	83	55	0.6
SSIR 300 45 F	300	200	83	55	0.7

1 : End extension measurement applies to both ends of the fitting
 Cat. Nos. given in the table are for inside risers. For outside risers substitute SIR for SIR
 Inside and outside risers are not available in PG finish
 For risers in PG finish use adjustable risers for all angles up to 90°, p. 42

30° inside and outside risers – dimensions and weights

30° inside riser

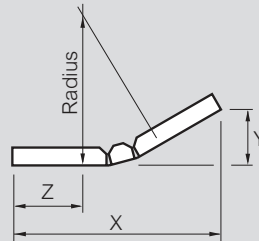

30° outside riser

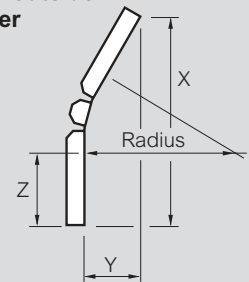

Cat. Nos.	Width	X	Y	Z'	Weight (kg)
SSIR 50 30 F	50	140	37	55	0.1
SSIR 75 30 F	75	140	37	55	0.2
SSIR 100 30 F	100	140	37	55	0.2
SSIR 150 30 F	150	140	37	55	0.3
SSIR 225 30 F	225	177	47	55	0.7
SSIR 300 30 F	300	177	47	55	0.7

1 : End extension measurement applies to both ends of the fitting
 Cat. Nos. given in the table are for inside risers. For outside risers substitute SIR for SIR
 Inside and outside risers are not available in PG finish
 For risers in PG finish use adjustable risers for all angles up to 90°, p. 42

Key : Replace the letter shown in red with your choice from the following options :

F = Finish : **G** (hot dip galvanised after manufacture),
PG (pre-galvanised steel), **S** (stainless steel)

All dimensions (mm) are nominal

Swifts® SS light duty fittings

inside and outside risers – 90°, 60°, 45° and 30° (continued)

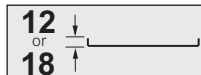

■ Dimensions and weights – inside and outside risers 90°, 60°, 45° and 30°

Dimensions

X = Overall length of fitting from each end in the horizontal (including integral coupler)

Y = Overall length of fitting from each end in the vertical (including integral coupler)

Z = End extension of integral coupler

Weights

All weights given are in kilograms (kg) and are for hot dip galvanised G finish

To obtain the appropriate component weight in other finishes, multiply the given weight by the following factors :

Stainless steel (S) x 0.94

■ Assembly – inside and outside risers 90°, 60°, 45° and 30°

Coupling detail



Note

Quantity of bed fasteners

50 - 225 mm wide tray = 4

300 mm wide tray = 6

Fasteners (not included)

For G finish

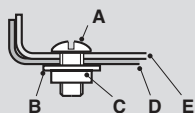

A M6 x 12 roofing bolt

B Roofing washer

C M6 square nut

D Fitting

E Straight length

For S finish

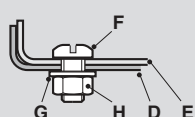

F M6 x 12 panhead screw

G M6 form A washer

H M6 hexagon nut

Fastener finishes

For risers with G finish, fasteners are galvanised or zinc plated

For risers with S finish, fasteners are stainless steel

■ Dimensions and weights

Adjustable risers can be used as an inside or outside riser for any angle up to 90°

Minimum radius = 200 mm
 Maximum radius = 300 mm
 Overall length when flat = 554 mm

Dimensions

Cat. No. SSAR **W F**

Used as inside riser

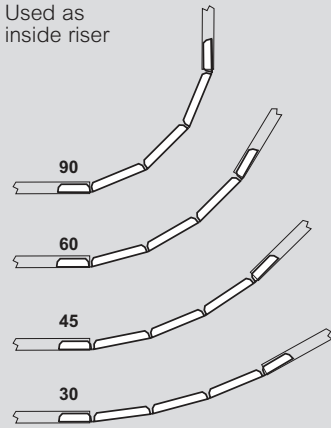

Used as outside riser

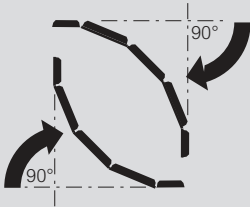
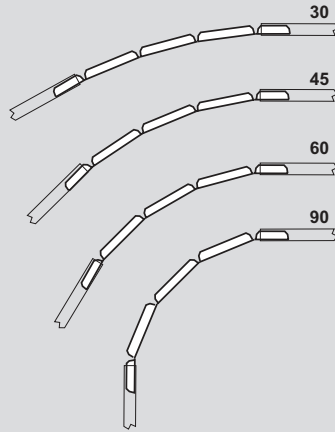

Cat. Nos.	Width	Weight (kg)
SSAR 50 F	50	0.4
SSAR 75 F	75	0.6
SSAR 100 F	100	0.8
SSAR 150 F	150	1.0
SSAR 225 F	225	1.5
SSAR 300 F	300	2.0

Weights

All weights given are in kilograms (kg) and are for hot dip galvanised G finish

To obtain the appropriate component weight in other finishes, multiply the given weight by the following factors :

Stainless steel (S) x 0.94
 Pre-galvanised (PG) x 0.96

Key : Replace the letter shown in red with your choice from the following options :

F = Finish : **G** (hot dip galvanised after manufacture),
PG (pre-galvanised steel), **S** (stainless steel)

■ Assembly

As many riser segments as necessary may be inserted into the end of the straight length, thus avoiding the need for cutting

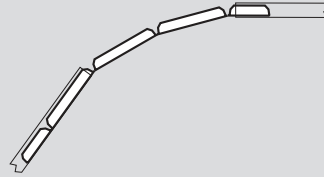

Coupling detail

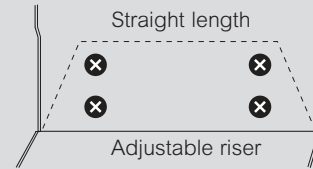

Note

Quantity of bed fasteners
 50 - 225 mm wide tray = 4
 300 mm wide tray = 6

Fasteners (not included)

For **G** and **PG** finish

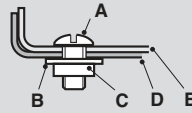

- A M6 x 12 roofing bolt
- B Roofing washer
- C M6 square nut
- D Fitting
- E Straight length

For **S** finish

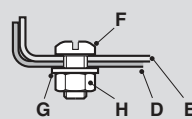

- F M6 x 12 panhead screw
- G M6 form A washer
- H M6 hexagon nut

Fastener finishes

For adjustable risers with G and PG finishes, fasteners are galvanised or zinc plated

For adjustable risers with S finish, fasteners are stainless steel

Swifts® SS light duty fittings

equal tees



Equal tees dimensions and weights

Dimensions

Cat. No. SST **W F**

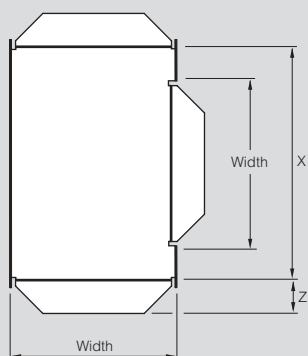

X = Length of fitting from each end (excluding integral coupler)

Z = End extension of integral coupler

Cat. Nos.	Width	X	Z	Weight (kg)
SST 50 F	50	167	32	0.2
SST 75 F	75	192	32	0.2
SST 100 F	100	217	32	0.4
SST 150 F	150	267	32	0.6
SST 225 F	225	342	57	1.2
SST 300 F	300	417	57	1.9

Minimum cable radius = 50 mm

Weights

All weights given are in kilograms (kg) and are for hot dip galvanised G finish

To obtain the appropriate component weight in other finishes, multiply the given weight by the following factors :

Stainless steel (S) x 0.94
Pre-galvanised (PG) x 0.96

Assembly

Coupling detail

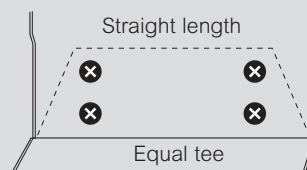

Note

Quantity of bed fasteners
50 - 225 mm wide tray = 4
300 mm wide tray = 6

Fasteners (not included)

For G and PG finish

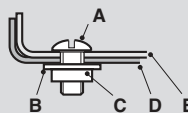

- A M6 x 12 roofing bolt
- B Roofing washer
- C M6 square nut
- D Fitting
- E Straight length

For S finish

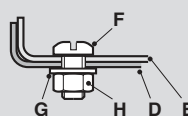

- F M6 x 12 panhead screw
- G M6 form A washer
- H M6 hexagon nut

Fastener finishes

For equal tees with G and PG finishes, fasteners are galvanised or zinc plated

For equal tees with S finish, fasteners are stainless steel

Key : Replace the letter shown in red with your choice from the following options :

F = Finish : **G** (hot dip galvanised after manufacture),
PG (pre-galvanised steel), **S** (stainless steel)

All dimensions (mm) are nominal

4 way crosspieces dimensions and weights

Dimensions

Cat. No. SSX **W F**

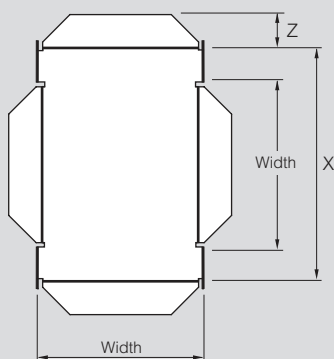

X = Length of fitting from each end (excluding integral coupler)
Z = End extension of integral coupler

Cat. Nos.	Width	X	Z	Weight (kg)
SSX 50 F	50	167	32	0.2
SSX 75 F	75	192	32	0.2
SSX 100 F	100	217	32	0.4
SSX 150 F	150	267	57	0.6
SSX 225 F	225	342	57	1.3
SSX 300 F	300	417	57	2.0

Minimum cable radius = 50 mm

Weights

All weights given are in kilograms (kg) and are for hot dip galvanised G finish

To obtain the appropriate component weight in other finishes, multiply the given weight by the following factors :

Stainless steel (S) x 0.94
Pre-galvanised (PG) x 0.96

Assembly

Coupling detail

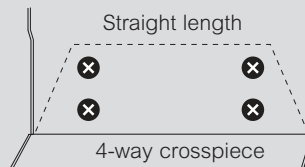

Note

Quantity of bed fasteners
50 - 225 mm wide tray = 4
300 mm wide tray = 6

Fasteners (not included)

For G and PG finish

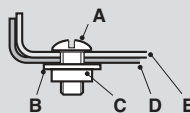

- A M6 x 12 roofing bolt
- B Roofing washer
- C M6 square nut
- D Fitting
- E Straight length

For S finish

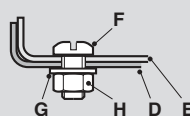

- F M6 x 12 panhead screw
- G M6 form A washer
- H M6 hexagon nut

Fastener finishes

For crosspieces with G and PG finishes, fasteners are galvanised or zinc plated

For crosspieces with S finish, fasteners are stainless steel

Key : Replace the letter shown in red with your choice from the following options :

F = Finish : **G** (hot dip galvanised after manufacture),
PG (pre-galvanised steel), **S** (stainless steel)

All dimensions (mm) are nominal

Swifts® SS light duty fittings

straight reducers

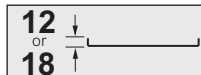

■ Dimensions and weights

Dimensions

Cat. No. SSR **W K F**

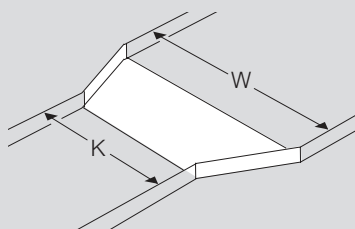
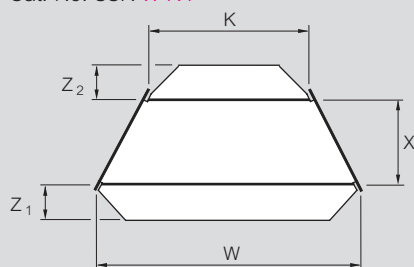

W = Main fitting width
 K = Reduced width
 X = Length of fitting from each end (excluding integral coupler)
 Z₁ = End extension of integral coupler
 Z₂ = End extension of integral coupler

Width (W)	Width (K)	Cat. Nos.	Dimensions (mm)			Weight (kg)
			X	Z ₁	Z ₂	
75	50	SSR 75 50 F	75	32	32	0.1
100	50	SSR 100 50 F	150	32	32	0.2
	75	SSR 100 75 F	75	32	32	0.1
150	50	SSR 150 50 F	150	32	32	0.3
	75	SSR 150 75 F	150	32	32	0.3
	100	SSR 150 100 F	75	32	32	0.2
225	50	SSR 225 50 F	300	57	32	0.4
	75	SSR 225 75 F	150	57	32	0.4
	100	SSR 225 100 F	150	57	32	0.5
	150	SSR 225 150 F	75	57	32	0.3
300	50	SSR 300 50 F	300	57	32	0.9
	75	SSR 300 75 F	300	57	32	1.0
	100	SSR 300 100 F	150	57	32	0.6
	150	SSR 300 150 F	150	57	32	0.7
	225	SSR 300 225 F	75	57	57	0.5

To create the Cat. No., add the main run width (W), to the reduced run width (K) and the finish (F)

Example :

For a hot dip galvanised reducer reducing from 300 mm to 150 mm :
 SSR 300 150 G

Weights

All weights given are in kilograms (kg) and are for hot dip galvanised G finish

To obtain the appropriate component weight in other finishes, multiply the given weight by the following factors :

Stainless steel (S) x 0.94
 Pre-galvanised (PG) x 0.96

Key : Replace the letter shown in red with your choice from the following options :

F = Finish : **G** (hot dip galvanised after manufacture),
PG (pre-galvanised steel), **S** (stainless steel)

■ Assembly

Coupling detail

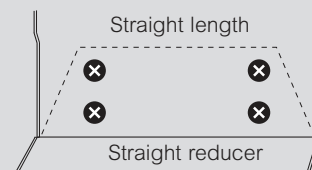

Note

Quantity of bed fasteners
 50 - 225 mm wide tray = 4
 300 mm wide tray = 6

Fasteners (not included)

For G and PG finish

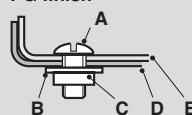

- A M6 x 12 roofing bolt
- B Roofing washer
- C M6 square nut
- D Fitting
- E Straight length

For S finish

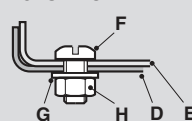

- F M6 x 12 panhead screw
- G M6 form A washer
- H M6 hexagon nut

Fastener finishes

For reducers with G and PG finishes, fasteners are galvanised or zinc plated

For reducers with S finish, fasteners are stainless steel

All dimensions (mm) are nominal

Swifts® MRF medium duty return flange

straight lengths

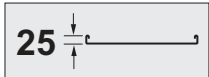

■ Dimensions and weights

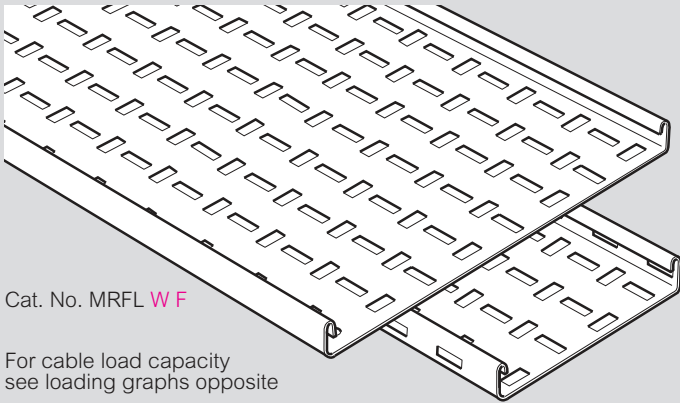

Cat. No. MRFL **WF**

For cable load capacity see loading graphs opposite

Dimensions

Standard length 3 m

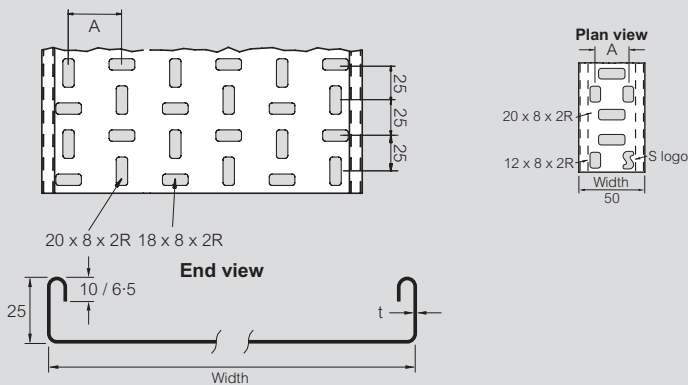

Width (mm)	A (mm)
50	25.00
75	37.50
100	31.75
150 to 900	37.50

R = radius

Gauges and weights

The gauge 't' for each cable tray width and finish can vary by product and range

Non-standard gauges and finishes are available to special order, contact us on +44 (0) 345 605 4333

Cat. Nos.	Width (mm)	Weight (kg)	Gauge t (mm)	
			G	PG
MRFL 50 F	50	2.0	0.7	0.7
MRFL 75 F	75	2.6	0.7	0.7
MRFL 100 F	100	3.0	0.8	0.7
MRFL 150 F	150	3.9	0.8	0.8
MRFL 225 F	225	6.8	1.0	0.8
MRFL 300 F	300	9.2	1.2	1.0
MRFL 450 F	450	16.5	1.2	1.2
MRFL 600 F	600	21.6	1.2	1.2
MRFL 750 F	750	33.7	1.5	1.4
MRFL 900 F	900	39.7	1.5	1.4

All weights given are in kilograms (kg) and are for a 3 m straight length in hot dip galvanised G finish

To obtain the appropriate component weight in other finishes, multiply the given weight by the following factors :

- Deep galvanised (D) x 1.06
- Stainless steel (S) x 0.94
- Pre-galvanised (PG) x 0.96
- Powder coated (E) x 0.97

Sheared steel (particularly stainless steel) does have relatively sharp edges and protective gloves must be worn during handling

■ Loading graphs

Load tests carried out to BS EN 61537 and shown in kg/m

Cable fill figure is the maximum physical load of cables that can be fitted into tray and is based on 1700 kg/m³ as detailed in the BEAMA "Best Practice guide to cable ladder and cable tray systems"

The loads shown on all graphs are the safe recommended maximum loads that can be applied and must include wind, snow and any other external forces in addition to the cable load

The graphs show the maximum load for tray installed at a support spacing within its recommended range

50-300 mm width trays

MRF G SWL 50-300

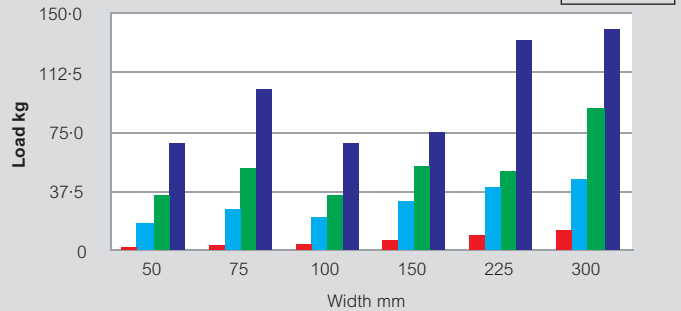

Table shown with results up to 300 mm wide obtained using the Swiftclip

450-900 mm width trays

MRF G SWL 450-900

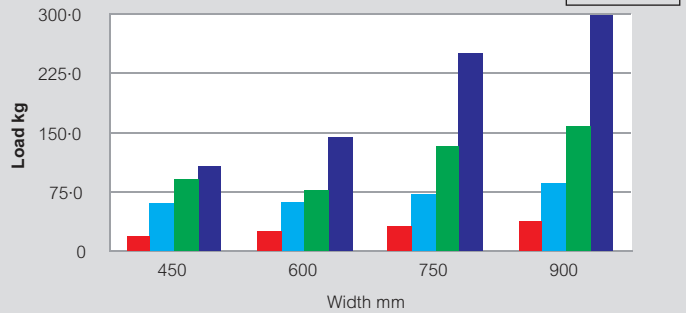

Table shown with results of 450 mm wide and above using Swiftgrips and UF fishplates

For lengths 450 mm wide and greater, the addition of fishplate Cat. No. WF **F** across the underside of the length-to-length joint provides added strength and increases the safe working load, **p. 105**

■ Finishes and standards

Standard stocked finish :

G Hot dip galvanised after manufacture to BS EN ISO 1461

PG Pre-galvanised steel to BS EN 10346 : 2009 grade DX51D

Additional finishes :

D Deep galvanised high silicon steel made from BS EN 10025-5 : 2004 Grade S355JOWP

S Stainless steel to BS EN 10088 - 2 grade 1.4404 (equivalent to 316L31)

E Powder coated (black RAL 9005)

Note

50 mm wide not available in deep galvanised (D) finish

All dimensions (mm) are nominal

Key : Replace the letter shown in red with your choice from the following options :

F = Finish : **G** (hot dip galvanised after manufacture), **D** (deep galvanised), **PG** (pre-galvanised steel), **S** (stainless steel), **E** (powder coated black RAL 9005)

➔ Coupler sets and fixing options : see p. 47-50

➔ Fishplates : see p. 105

Swifts® MRF straight length to straight length coupling

standard couplers and Swiftclip / Swiftgrip

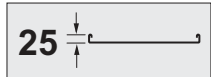

Standard couplers and Swiftclip / Swiftgrip

Couplers are required for joining together MRF straight lengths. MRFC standard couplers are supplied in pairs. MRFC 50 standard coupler is supplied singly. 2 x Swiftclips are required for each coupling and are used with tray widths up to and including 300 mm. For 450 mm to 900 mm tray, use Swiftgrip (2 per coupling). 1 x Swiftclip is required for 50 mm tray and MRFC 50 couplers. Swiftclip and Swiftgrip are supplied in packs of 10. As an alternative coupling method, use standard couplers and quick bolt fasteners (Cat. No. QBF) and a tool, see p. 48, or standard couplers and fasteners, see p. 48-49.

Installation using Swiftclip - 50 mm to 300 mm wide tray

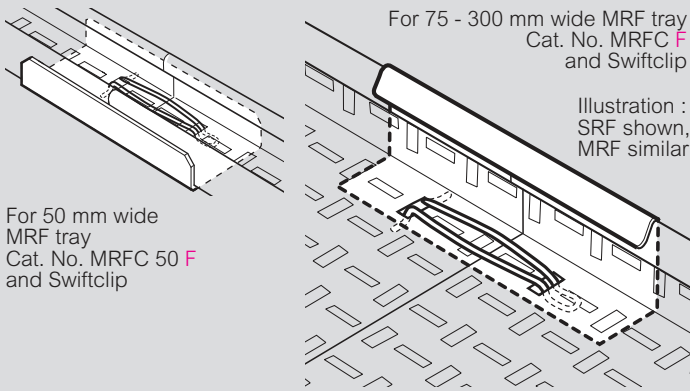

Standard couplers		Swiftclip	
Cat. Nos.	Tray range	Cat. Nos.	Finish
MRFC 50 F ¹	MRF	SCLPG	PG
MRFC F ²	MRF	SCLG	G

1 : MRFC 50 for 50 mm wide tray only
2 : MRFC for 75-900 mm wide tray only

Assembly using Swiftclip

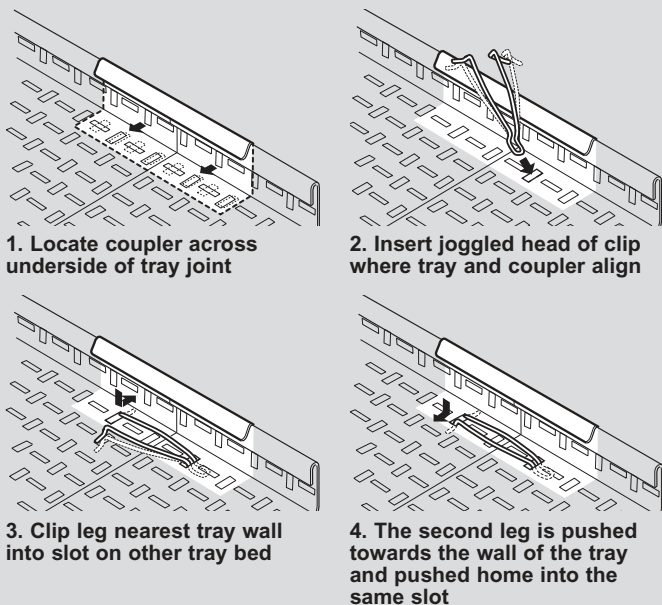

Repeat process on the other side of the tray, fitting the clip in the opposite direction. Ensure:

1. Head and feet of clip are clamping through tray and coupler
2. Clip should span across the joint

Installation using Swiftgrip

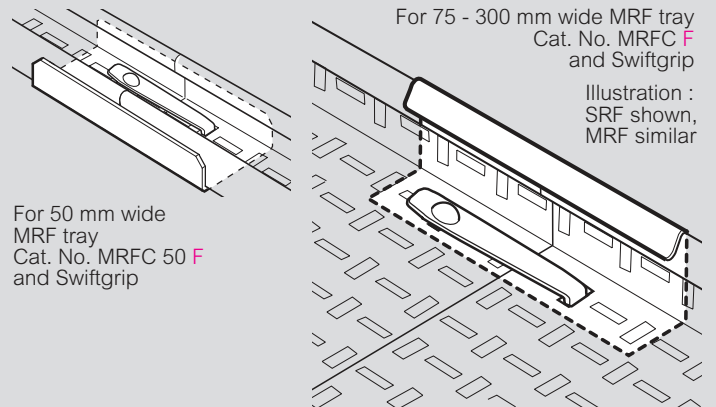

Swiftgrip Cat. No.	For tray finishes
SGR	PG and G

Assembly using Swiftgrip

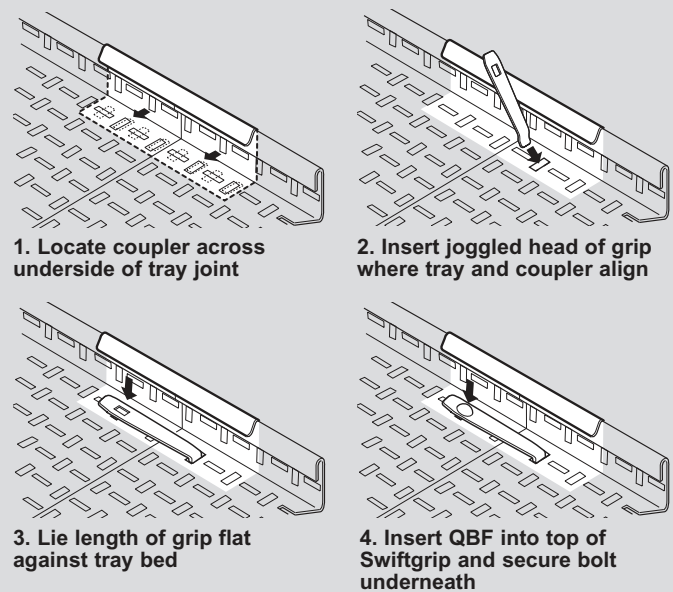

Repeat process on the other side of the tray, fitting the grip in the opposite direction. Ensure:

1. Head and bolt of grip are clamping through tray and coupler
2. Grip should span across the joint

All dimensions (mm) are nominal

Key : Replace the letter shown in red with your choice from the following options :

F = Finish : **G** (hot dip galvanised after manufacture), **D** (deep galvanised), **PG** (pre-galvanised steel), **S** (stainless steel), **E** (powder coated)

Swifts® MRF straight length to straight length coupling

standard couplers and Swiftclip / Swiftgrip (continued)
standard couplers and quick bolt fasteners

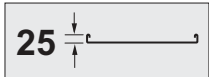

■ Dimensions and weights

Couplers - MRFC 50 F (for 50 mm wide tray) / MRFC (for 75 mm to 900 mm wide tray)

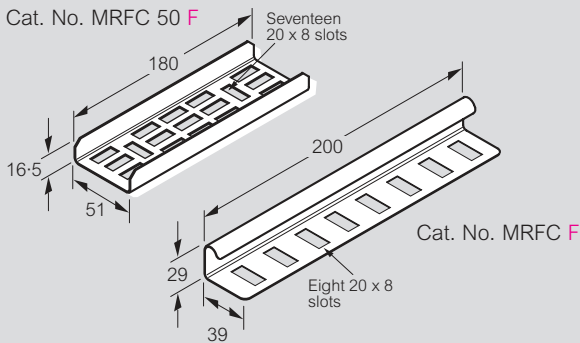

Cat. Nos.	Weight (kg)
MRFC 50 F	0.2 single
MRFC F	0.4 pair

Swiftclip (for 50 mm to 300 mm wide tray)

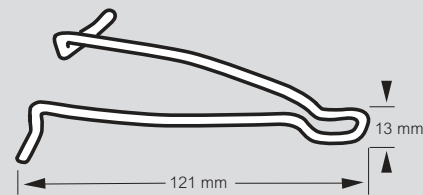

Cat. Nos.	Pack
SCLPG	10
SCLG	10

Swiftgrip

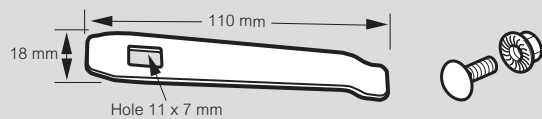

Cat. No.	Pack
SGR	10

Weights

All weights given are in kilograms (kg) and are for hot dip galvanised G finish
To obtain the appropriate component weight in other finishes, multiply the given weight by the following factors :

Deep galvanised (D)	x 1.06
Stainless steel (S)	x 0.94
Pre-galvanised (PG)	x 0.96
Powder coated (E)	x 0.97

All dimensions (mm) are nominal

Key : Replace the letter shown in red with your choice from the following options :

F = Finish : **G** (hot dip galvanised after manufacture),
D (deep galvanised), **PG** (pre-galvanised steel),
S (stainless steel), **E** (powder coated)

All dimensions (mm) are nominal

➔ Straight lengths : see p. 46

■ Standard couplers and quick bolt fasteners

Compared with conventional nuts and bolts, quick bolt fasteners are a stronger, faster, easier and safer method of joining together tray. Square-shafted quick bolts lock firmly into position before fixing. The nuts, which have integral washers and a serrated edge to reduce slip and improve earthing, can then be easily tightened using a power tool. Supplied in packs containing 100 quick bolt fasteners and a FREE power tool attachment.

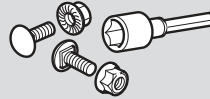

■ Installation

Typical installation as per standard couplers, replacing nuts, bolts and washers with quick bolt fasteners

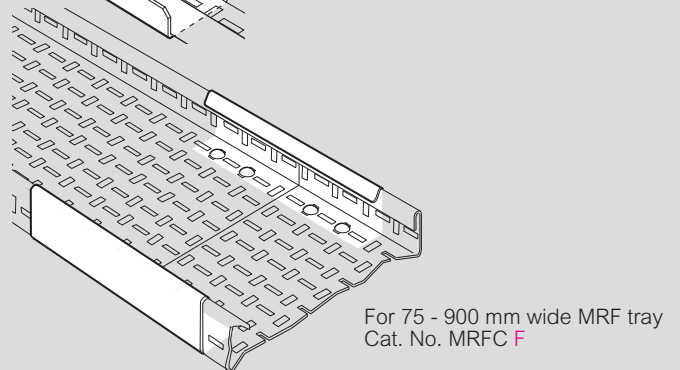

■ Assembly

Bring together two lengths and fit a coupler on the outside of adjacent flanges at both sides of the tray joint

Locate the coupler and insert bolts through aligning slots in each tray bed and coupler as shown and secure with nuts

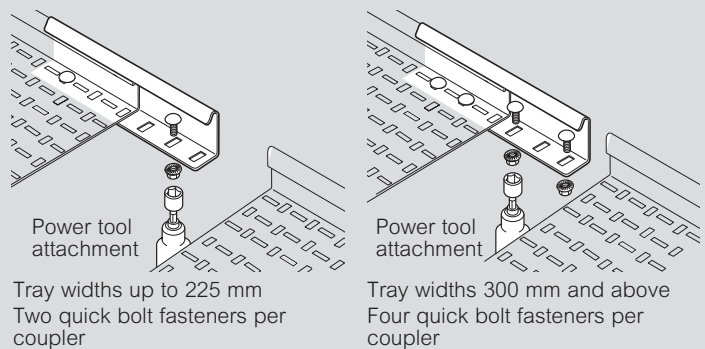

Quick bolt fasteners

Cat. Nos.	Pack	Size (mm)	Finish
QBF	100	M6 x 12	Dacromet
QBFS	100	M6 x 12	Stainless steel

For G, PG and S finish

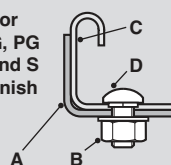

A Coupler
B M6 flange nut
C Straight length
D M6 coach bolt

For coupler dimensions see above left

Swifts® MRF straight length to straight length coupling

standard couplers and standard fasteners



Standard couplers and standard fasteners

Couplers are required for joining together MRF straight lengths or cut lengths of tray

MRFC standard couplers are supplied in pairs

MRFC 50 standard coupler is supplied singly

Supplied without fasteners – use M6 nuts, bolts and washers (see opposite)

Installation (typical)



For 50 mm wide MRF tray
Cat. No. MRFC 50 F

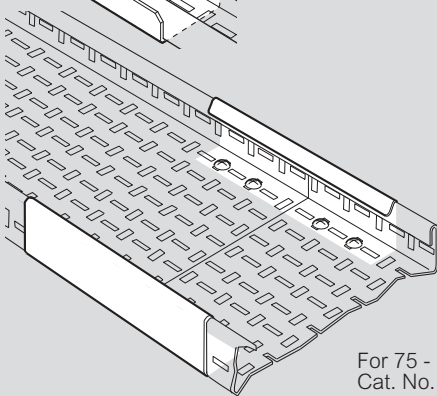

For 75 - 900 mm wide MRF tray
Cat. No. MRFC F

Illustration : SRF shown, MRF similar

Standard couplers

Cat. Nos.	Tray range
MRFC 50 F ⁽¹⁾	MRF
MRFC F ⁽²⁾	MRF

(1) MRFC 50 for 50 mm wide tray only

(2) MRFC for 75-900 mm wide tray only

Assembly

For 50 mm wide MRF tray

Bring together two lengths and locate the coupler across the underside of the tray joint as shown

Insert two roofing bolts through aligning slots in each tray bed and into the coupler (four bolts per coupler) and secure with roofing washers and nuts

For 75 - 900 mm wide MRF tray

Bring together two lengths and fit a coupler on the outside of adjacent flanges at both sides of the tray joint

Locate the coupler as shown and insert two roofing bolts through aligning slots in each tray bed and coupler (four bolts per coupler), and secure with roofing washers and nuts

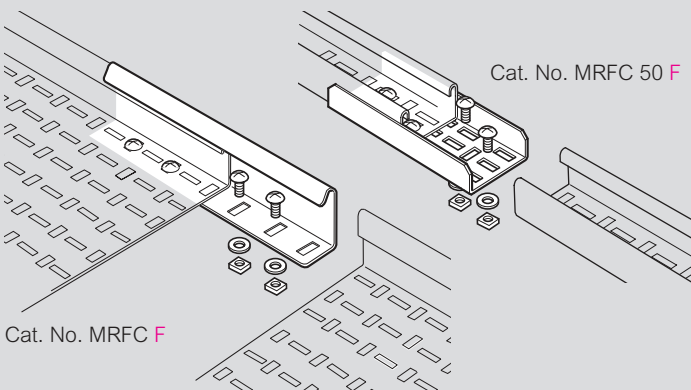

Cat. No. MRFC F

Assembly (continued)

Fasteners

Cat. No. MRFC 50 F



Cat. No. MRFC F

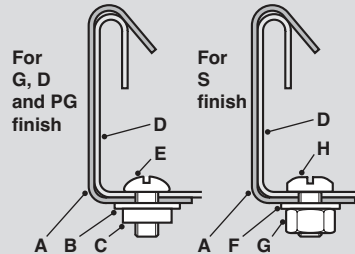

- A Coupler
- B Roofing washer
- C M6 square nut
- D Straight length
- E M6 x 12 roofing bolt
- F M6 form A washer
- G M6 hexagon nut
- H M6 x 12 pan head screw

Fastener finishes

For lengths and fittings with G, D and PG finishes fasteners are galvanised or zinc plated. For trays and fittings with S finish, fasteners are corrosion resistant stainless Grade A470

For lengths and fittings with E finish the choice of material for fasteners will depend on the installation environment – contact us on +44 (0) 345 605 4333

Note

For quick bolt fasteners, see p. 48

Dimensions and weights

Cat. No. MRFC 50 F

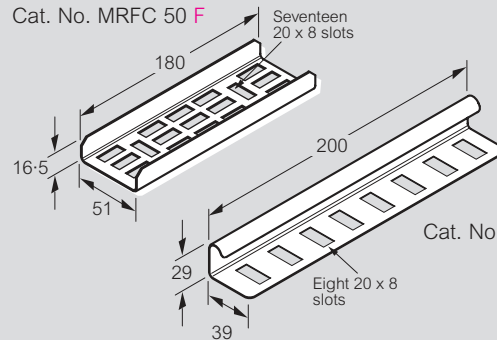

Cat. Nos.	Weight (kg)
MRFC 50 F	0.2 single
MRFC F	0.4 pair

Weights

All weights given are in kilograms (kg) and are for hot dip galvanised G finish

To obtain the appropriate component weight in other finishes, multiply the given weight by the following factors :

Pre-galvanised (PG) x 0.96

All dimensions (mm) are nominal

➔ Straight lengths : see p. 46

■ Straight length to fitting coupling using Swiftclip – 50 mm to 300 mm wide tray

Cable tray fittings must be properly supported. The ideal location for supports is shown in step 2, i.e. 150 mm from the fitting to length joint. For further details see Design Notes, Recommended Support Locations, p. 132

1
Where necessary re-align the fitting flange tabs from their transit position to their installation position

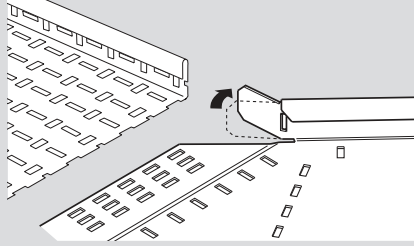

2
When a straight length of cable tray has to be cut back to accept a fitting, always fit the uncut end to the adjacent straight length; the cut end should be connected to the fitting

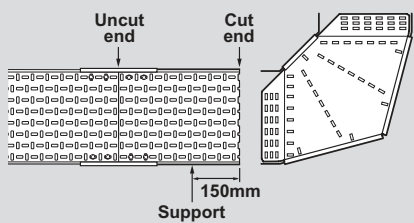

3
Offer the fitting at an angle to the straight length and locate, ensuring that the joggled fishplate fits under the tray bed and the flange tabs slide inside the length flanges

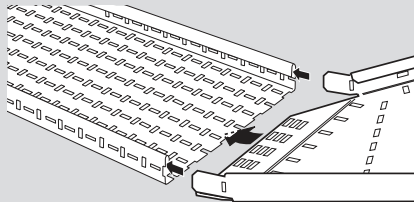

4
Insert joggled head of clip through slots in the tray bed into aligning slots in the fitting fishplate, then clip legs into slot on tray bed

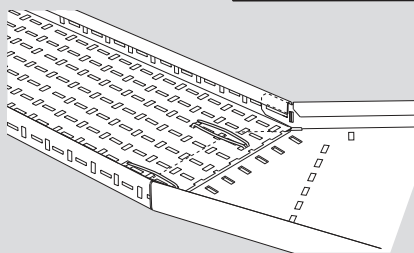

5
Ensure head of clip is clamping through tray and fitting

■ Straight length to fitting coupling using fasteners

Cable tray fittings must be properly supported. The ideal location for supports is shown in step 2, i.e. 150 mm from the fitting to length joint. For further details see Design Notes, Recommended Support Locations, p. 132

1
Where necessary re-align the fitting flange tabs from their transit position to their installation position

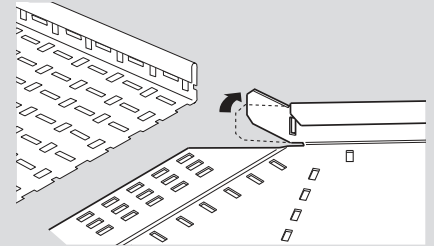

2
When a straight length of cable tray has to be cut back to accept a fitting, always fit the uncut end to the adjacent straight length; the cut end should be connected to the fitting

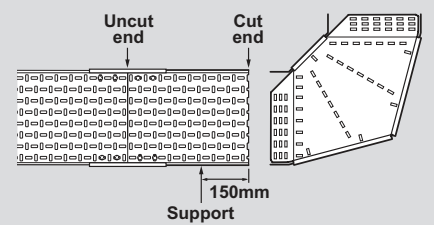

3
Offer the fitting at an angle to the straight length and locate, ensuring that the joggled fishplate fits under the tray bed and the flange tabs slide inside the length flanges

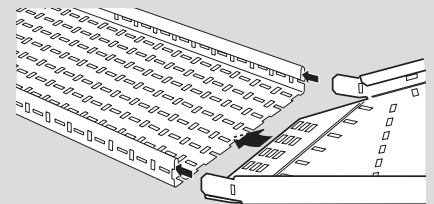

4
Insert roofing bolts or QBF through slots in the tray bed in to aligning slots in the fitting fishplate and secure with roofing washers and nuts

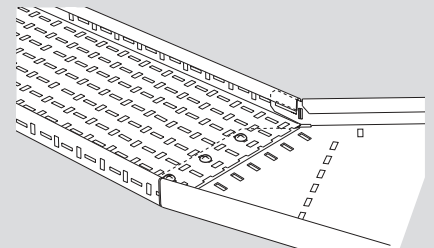

Note

Fasteners stated are for D, G and PG finishes
For lengths and fittings with S finish use fasteners listed below

Fasteners

Minimum number of fasteners per joint (not included) :
Widths up to 225 = 2
Widths 300 to 600 = 3
Widths 750 and 900 = 4

Roofing bolts

For G and PG finish

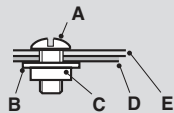

For S finish

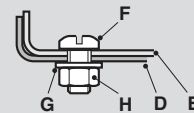

- A M6 x 12 roofing bolt
- B Roofing washer
- C M6 square nut
- D Fitting
- E Straight length
- F M6 x 12 pan head screw
- G M6 form A washer
- H M6 hexagon nut

Quick bolt fasteners

For G, PG and S finish

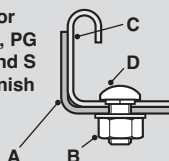

- A Coupler
- B M6 flange nut
- C Straight length
- D M6 coach bolt

Fastener finish

For lengths and fittings with G, D and PG finishes, fasteners are galvanised or zinc plated. For trays and fittings with S finish, fasteners are corrosion resistant stainless Grade A470
For lengths and fittings with E finish, the choice of material for fasteners will depend on the installation environment - contact us on +44 (0) 345 605 4333

Key : Replace the letter shown in red with your choice from the following options :

- F = Finish : G (hot dip galvanised after manufacture), D (deep galvanised), PG (pre-galvanised steel), S (stainless steel), E (powder coated)

All dimensions (mm) are nominal

→ Straight lengths : see p. 46

Swifts® MRF medium duty fittings

universal bracket and fishplate

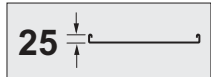

■ Universal bracket

The universal bracket can be easily folded at one or more of the 8 predetermined points. By overfolding a couple of times, the bracket can be split, for example on the centre line to make a hinged coupler or in between the outer flanges if the length of the bracket needs to be reduced

The square hole is provided to locate the shoulder of the quick bolt fastener – this side should be facing inwards towards the tray to avoid snagging cables

The pitch between each fold point is designed to match up with the Swifts range of MRF cable tray systems

By using different configurations the bracket can be folded to create numerous functions on-site, examples of which are shown below For MRF 300mm to 900 mm straight lengths, fixing holes must be drilled into the side wall of the tray

Cat. No. MRFUB F

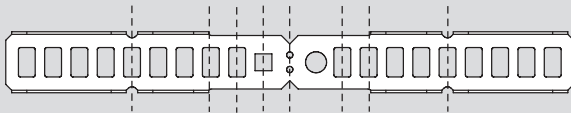

■ Installation (typical)

Side dropout

Tee

Bend

Riser

Flange assembly

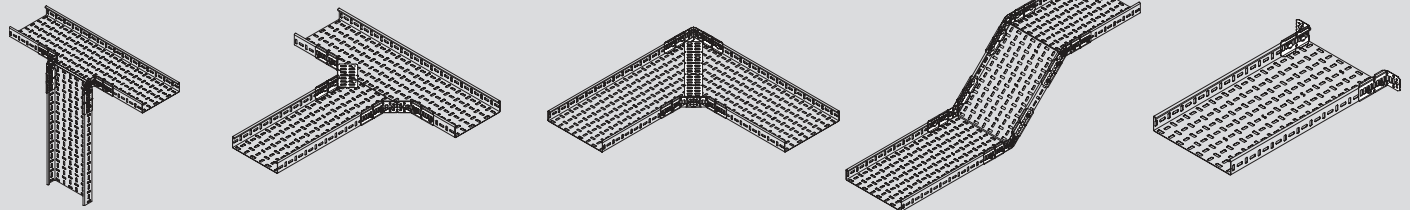

■ Dimensions

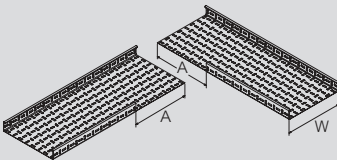

Above dimensions are for 90° bend with overlap joint

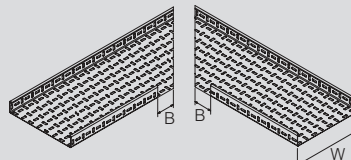

Above dimensions are for 90° bend with diagonal joint. Diagonal cuts are 45°

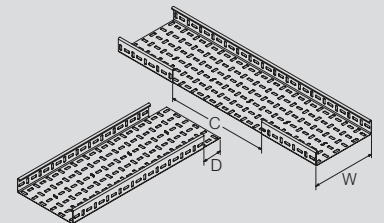

Note 1 : Dimensions are for tee with fishplate joint

Note 2 : For overlap joint tee use 'D' + 50

Cat. Nos.	Width (W)	Overlap A	Diagonal B	Tee	
				C	D
MRFL 75 F	75	80	65	195	60
MRFL 100 F	100	105	65	220	60
MRFL 150 F	150	155	65	270	60
MRFL 225 F	225	230	65	345	60
MRFL 300 F	300	305	65	420	60

Illustrations : SRF shown. MRF similar

■ Handed and straight reducer configurations

Figures show approximated reduced width

Left or right handed reducers are not currently available as a standard factory fabricated fitting

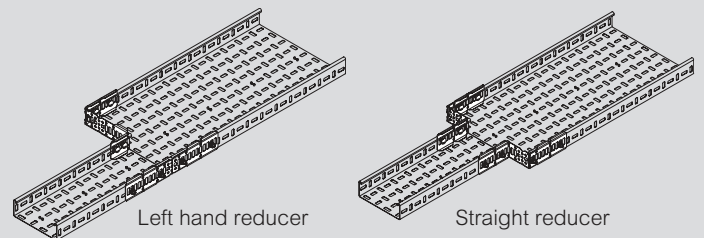

		MRFL													
Smaller Size		50 mm		75 mm		100 mm		150 mm		225 mm		300 mm		450 mm	
Larger Size		Handed	Straight	Handed	Straight	Handed	Straight	Handed	Straight	Handed	Straight	Handed	Straight	Handed	Straight
75 mm		25	12	-	-	-	-	-	-	-	-	-	-	-	-
100 mm		50	25	25	12	-	-	-	-	-	-	-	-	-	-
150 mm		100	50	75	37	50	25	-	-	-	-	-	-	-	-
225 mm		-	87	150	75	125	62	75	37	-	-	-	-	-	-
300 mm		-	-	-	112	-	100	150	75	75	37	-	-	-	-
450 mm		-	-	-	-	-	-	-	150	-	112	150	75	-	-
600 mm		-	-	-	-	-	-	-	-	-	-	150	150	75	-

All dimensions (mm) are nominal

■ 90° flat bends – dimensions and weights

Cat. No. MRFB **W F**

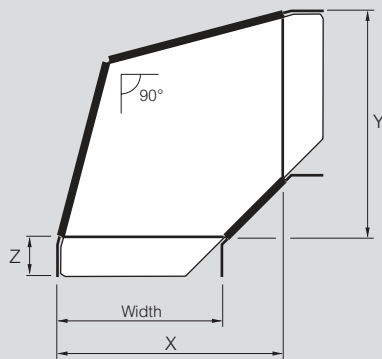

Cat. Nos.	Width	X	Y	Z	Weight (kg)
MRFB 50 F	50	172	172	55	0.3
MRFB 75 F	75	197	197	55	0.4
MRFB 100 F	100	221	221	55	0.6
MRFB 150 F	150	272	272	55	0.8
MRFB 225 F	225	345	345	55	1.3
MRFB 300 F	300	420	420	55	1.8
MRFB 450 F	450	570	570	55	4.2
MRFB 600 F	600	720	720	55	5.8
MRFB 750 F	750	870	870	55	11.7
MRFB 900 F	900	1020	1020	55	15.8

Also consider the versatile adjustable bend for widths 50 mm - 300 mm, p. 54-55

Note

50 mm wide not available in D finish

■ 60° flat bends – dimensions and weights

Cat. No. MRFB **W 60 F**

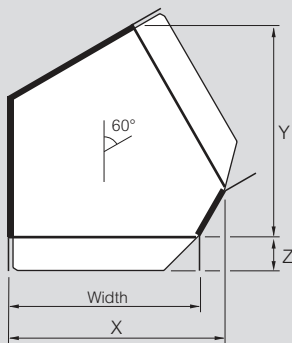

Cat. Nos.	Width	X	Y	Z	Weight (kg)
MRFB 50 60 F	50	108	148	55	0.3
MRFB 75 60 F	75	133	169	55	0.5
MRFB 100 60 F	100	158	191	55	0.6
MRFB 150 60 F	150	208	234	55	0.8
MRFB 225 60 F	225	283	299	55	1.3
MRFB 300 60 F	300	358	364	55	1.4
MRFB 450 60 F	450	509	494	55	3.0
MRFB 600 60 F	600	659	624	55	4.6
MRFB 750 60 F	750	809	754	55	6.6
MRFB 900 60 F	900	959	884	55	9.1

Also consider the versatile adjustable bend for widths 50 mm - 300 mm, p. 54-55

Note

50 mm wide not available in D finish

■ 45° flat bends – dimensions and weights

Cat. No. MRFB **W 45 F**

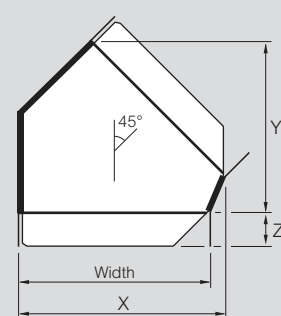

Cat. Nos.	Width	X	Y	Z	Weight (kg)
MRFB 50 45 F	50	83	120	55	0.2
MRFB 75 45 F	75	108	138	55	0.4
MRFB 100 45 F	100	133	156	55	0.5
MRFB 150 45 F	150	183	191	55	0.8
MRFB 225 45 F	225	258	244	55	1.2
MRFB 300 45 F	300	333	297	55	1.1
MRFB 450 45 F	450	483	403	55	2.3
MRFB 600 45 F	600	633	509	55	3.5
MRFB 750 45 F	750	783	615	55	5.1
MRFB 900 45 F	900	933	721	55	6.8

Also consider the versatile adjustable bend for widths 50 mm - 300 mm, p. 54-55

Note

50 mm wide not available in D finish

■ 30° flat bends – dimensions and weights

Cat. No. MRFB **W 30 F**

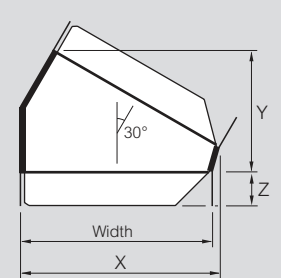

Cat. Nos.	Width	X	Y	Z	Weight (kg)
MRFB 50 30 F	50	63	85	55	0.2
MRFB 75 30 F	75	88	98	55	0.2
MRFB 100 30 F	100	113	110	55	0.3
MRFB 150 30 F	150	163	135	55	0.5
MRFB 225 30 F	225	238	173	55	0.8
MRFB 300 30 F	300	313	210	55	1.1
MRFB 450 30 F	450	463	285	55	1.6
MRFB 600 30 F	600	613	360	55	2.5
MRFB 750 30 F	750	763	435	55	3.6
MRFB 900 30 F	900	913	510	55	4.8

Also consider the versatile adjustable bend for widths 50 mm - 300 mm, p. 54-55

Note

50 mm wide not available in D finish

Key : Replace the letter shown in red with your choice from the following options :

- F** = Finish : **G** (hot dip galvanised after manufacture),
- D** (deep galvanised), **PG** (pre-galvanised steel),
- S** (stainless steel), **E** (powder coated black RAL 9005)

→ MRF adjustable bends : see p. 54-55

All dimensions (mm) are nominal

Swifts® MRF medium duty fittings

flat bends – 90°, 60°, 45° and 30° (continued)

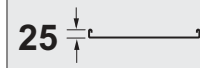

■ Dimensions and weights – flat bends 90°, 60°, 45° and 30°

Dimensions

X = Length of fitting from each end (excluding integral coupler)

Y = Length of fitting from each end (excluding integral coupler)

Z = End extension of integral coupler

Weights

All weights given are in kilograms (kg) and are for hot dip galvanised G finish

To obtain the appropriate component weight in other finishes, multiply the given weight by the following factors :

Deep galvanised (D)	x 1.06
Stainless steel (S)	x 0.94
Pre-galvanised (PG)	x 0.96
Powder coated (E)	x 0.97

■ Assembly using Swiftclip – flat bends 90°, 60°, 45° and 30°

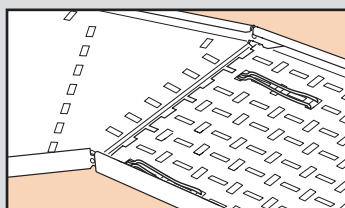

For fast fit connections of fittings and lengths (up to 300 mm wide) use Swiftclip, see p. 50

■ Assembly using fasteners – flat bends 90°, 60°, 45° and 30°

Coupling detail – 90°

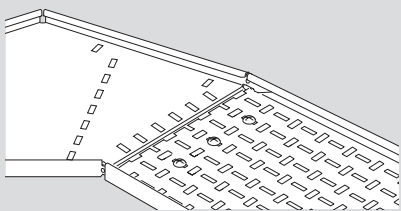

Coupling detail – 60°, 45° and 30°

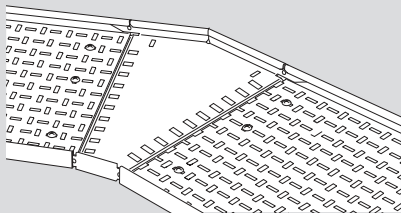

Flat bend to straight length coupling

Flat bends have integral couplers which fit into straight lengths whether they have been cut to length or not, without the need for further drilling

Each flat bend to length joint is secured with M6 x 12 bolts (roofing or pan head), nuts and washers or quick bolt fasteners (Cat. No. QBF), p. 50. Fasteners are not included

Minimum number of fasteners per joint :

Widths up to 225	= 2
Widths 300 to 600	= 3
Widths 750 and 900	= 4

Fastener finishes

For flat bends with G, D and PG finishes, fasteners are galvanised or zinc plated. For flat bends with S finish, fasteners are stainless steel. For flat bends with E finish, the choice of material for fasteners will depend on the installation environment. For further information, contact us on +44 (0) 345 605 4333

Minimum bend radius for cables – flat bends 90°

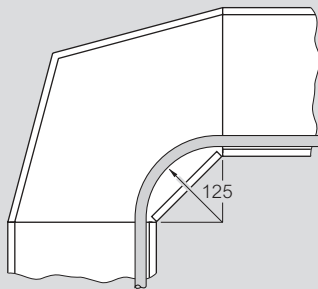

Minimum cable radius = 125 mm

Minimum bend radius for cables – flat bends 60°, 45° and 30°

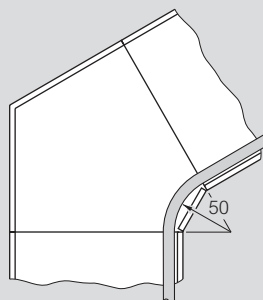

Minimum cable radius = 125 mm

Key : Replace the letter shown in red with your choice from the following options :

F = Finish : **G** (hot dip galvanised after manufacture),
D (deep galvanised), **PG** (pre-galvanised steel),
S (stainless steel), **E** (powder coated black RAL 9005)

➔ MRF adjustable bends : see p. 54-55

■ Dimensions and weights

Cat. No. MRFAB **WF**

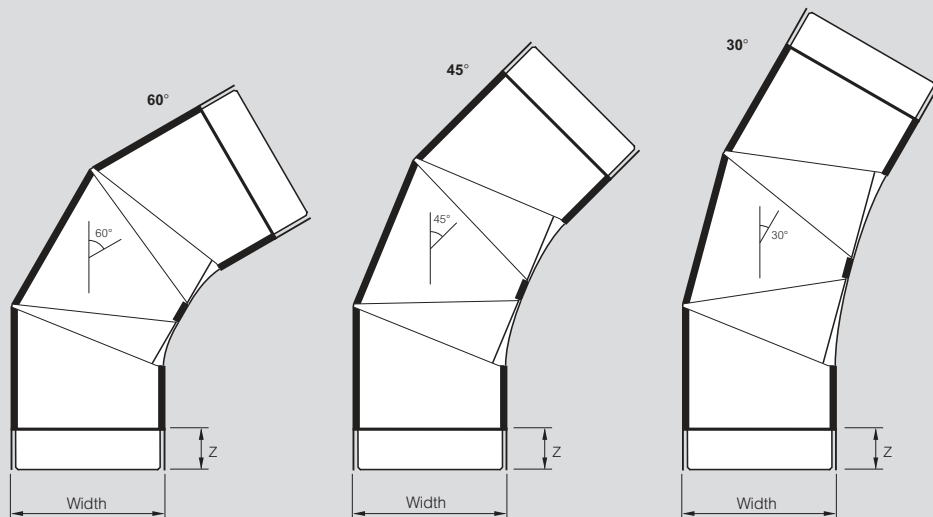

Cat. Nos.	Width	Z	Weight (kg)
MRFAB 50 F	50	55	0.3
MRFAB 75 F	75	55	0.5
MRFAB 100 F	100	55	0.6
MRFAB 150 F	150	55	1.0
MRFAB 225 F	225	55	1.9
MRFAB 300 F	300	55	3.0

For widths 450-900 mm use 60°, 45° and 30° flat bends, **p. 52-53**
 For widths 300 mm and below use adjustable flat bends for all angles up to 90°. Fixed angle flat bends are also available, **p. 52-53**

Note

50 mm wide not available in D finish

Dimensions

Z = End extension of integral coupler

Weights

All weights given are in kilograms (kg) and are for hot dip galvanised G finish

To obtain the appropriate component weight in other finishes, multiply the given weight by the following factors :

- Deep galvanised (D) x 1.06
- Stainless steel (S) x 0.94
- Pre-galvanised (PG) x 0.96
- Powder coated (E) x 0.97

Key : Replace the letter shown in red with your choice from the following options :

- F** = Finish : **G** (hot dip galvanised after manufacture),
D (deep galvanised), **PG** (pre-galvanised steel),
S (stainless steel), **E** (powder coated black RAL 9005)

All dimensions (mm) are nominal

MRF flat bends : see p. 52-53

Swifts® MRF medium duty fittings

adjustable flat bends – 50 to 300 mm wide (continued)

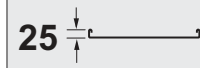

■ Assembly

Adjusting bend to any angle between 30° and 90°

Adjustable flat bends can be adjusted to any angle between 30° and 90°, refer to the diagram opposite

Insert fasteners through both slots **X** in the outer sections of the bed and the associated slots **Z** in the centre section of the bed. Adjust the bendable sections equally until the required angle is formed

Setting bend to specific angles

Adjustable flat bends can be set to specific fixed angles or they can be adjusted to any angle between 30° and 90° in increments of 7.5°

Note

When setting the adjustable flat bend to the required angle, ensure that the bendable inner flanges on the centre section engage in the return flanges on the outer sections

Angle (°)	Fastener holes
30	A + A
37.5	A + B
45	B + B
52.5	B + C
60	C + C
67.5	C + D
75	D + D
82.5	D + E
90	E + E

Refer to the table and the diagram below
Insert fasteners through both slots **X** in the outer sections of the bend and the appropriate holes (**A** to **E**) in the centre section of the bed
(2 x M6 fasteners included)

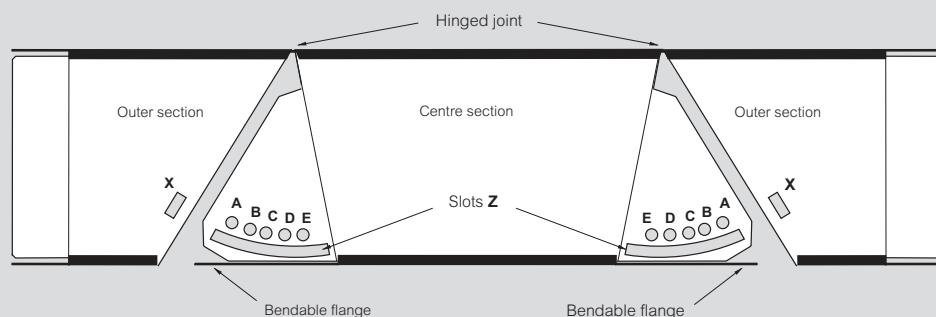

■ Assembly using Swiftclip – adjustable flat bends

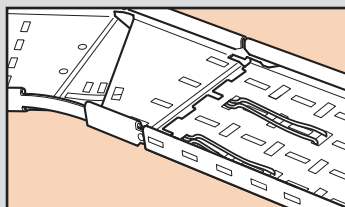

For fast fit connections of fittings and lengths (up to 300 mm wide) use Swiftclip, see p. 50

■ Assembly (continued)

Fastener finishes

For adjustable flat bends with G, D and PG finishes, fasteners are galvanised or zinc plated

For adjustable flat bends with S finish, fasteners are stainless steel

For adjustable flat bends with E finish, the choice of material for fasteners will depend on the installation environment. For further information, contact us on +44 (0) 345 605 4333

Minimum bend radius for cables

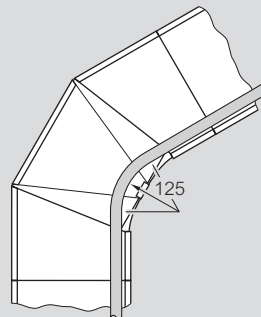

For details on how to set adjustable flat bends to angles, see below and opposite

■ Assembly using fasteners – adjustable flat bends

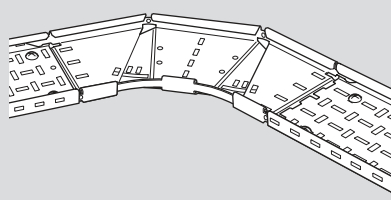

Adjustable flat bend to straight length coupling

Adjustable flat bends have integral couplers which fit into straight lengths whether they have been cut to length or not, without the need for further drilling

Each adjustable flat bend to length joint is secured with M6 x 12 bolts (roofing or pan head), nuts and washers or quick bolt fasteners (Cat. No. QBF), see p. 50. Fasteners are not included

Minimum number of fasteners per joint :

Widths up to 225 = 2
Width 300 = 3

Key : Replace the letter shown in red with your choice from the following options :

F = Finish : **G** (hot dip galvanised after manufacture),
D (deep galvanised), **PG** (pre-galvanised steel),
S (stainless steel), **E** (powder coated black RAL 9005)

All dimensions (mm) are nominal

➔ MRF flat bends : see p. 52–53

Swifts® MRF medium duty fittings

inside and outside risers – 90°, 60°, 45° and 30°

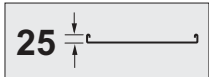

90° inside and outside risers – dimensions and weights

Dimensions

Cat. No. MRFIR **W F**

Cat. No. MRFOR **W F**

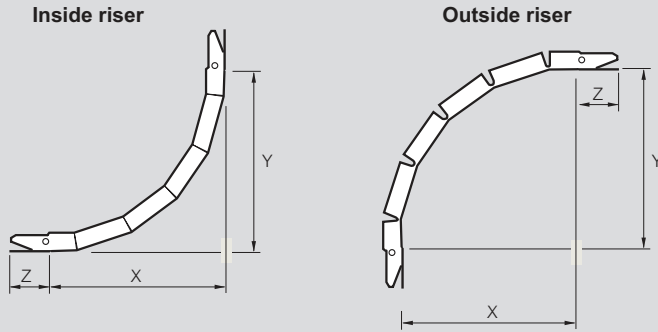

Cat. Nos.	Width	X	Y	Z	Weight (kg)
MRFIR 50 F	50	260	260	55	0.5
MRFIR 75 F	75	260	260	55	0.6
MRFIR 100 F	100	260	260	55	0.7
MRFIR 150 F	150	260	260	55	0.9
MRFIR 225 F	225	260	260	55	1.3
MRFIR 300 F	300	260	260	55	1.7
MRFIR 450 F	450	260	260	55	3.0
MRFIR 600 F	600	260	260	55	4.0
MRFIR 750 F	750	260	260	55	6.6
MRFIR 900 F	900	260	260	55	7.9

Cat. Nos. given in the table are for inside risers. For outside risers substitute MRFOR for MRFIR. All fixed risers radius = 260 mm

60° inside and outside risers – dimensions and weights

Cat. Nos.	Width	X	Y	Z	Weight (kg)
MRFIR 50 60 F	50	269	155	55	0.4
MRFIR 75 60 F	75	269	155	55	0.5
MRFIR 100 60 F	100	269	155	55	0.5
MRFIR 150 60 F	150	269	155	55	0.7
MRFIR 225 60 F	225	269	155	55	1.0
MRFIR 300 60 F	300	269	155	55	1.3
MRFIR 450 60 F	450	269	155	55	2.4
MRFIR 600 60 F	600	269	155	55	3.2
MRFIR 750 60 F	750	269	155	55	4.0
MRFIR 900 60 F	900	269	155	55	4.8

Cat. Nos. given in the table are for inside risers. For outside risers substitute MRFOR for MRFIR. All fixed risers radius = 260 mm

45° inside and outside risers – dimensions and weights

Cat. Nos.	Width	X	Y	Z	Weight (kg)
MRFIR 50 45 F	50	220	91	55	0.4
MRFIR 75 45 F	75	220	91	55	0.4
MRFIR 100 45 F	100	220	91	55	0.5
MRFIR 150 45 F	150	220	91	55	0.6
MRFIR 225 45 F	225	220	91	55	0.8
MRFIR 300 45 F	300	220	91	55	1.1
MRFIR 450 45 F	450	220	91	55	2.0
MRFIR 600 45 F	600	220	91	55	2.7
MRFIR 750 45 F	750	220	91	55	3.3
MRFIR 900 45 F	900	220	91	55	4.0

Cat. Nos. given in the table are for inside risers. For outside risers substitute MRFOR for MRFIR. All fixed risers radius = 260 mm

Key : Replace the letter shown in red with your choice from the following options :

- F** = Finish : **G** (hot dip galvanised after manufacture), **D** (deep galvanised), **PG** (pre-galvanised steel), **S** (stainless steel), **E** (powder coated black RAL 9005)

30° inside and outside risers – dimensions and weights

Cat. Nos.	Width	X	Y	Z	Weight (kg)
MRFIR 50 30 F	50	157	42	55	0.3
MRFIR 75 30 F	75	157	42	55	0.3
MRFIR 100 30 F	100	157	42	55	0.4
MRFIR 150 30 F	150	157	42	55	0.5
MRFIR 225 30 F	225	157	42	55	0.7
MRFIR 300 30 F	300	157	42	55	0.9
MRFIR 450 30 F	450	157	42	55	1.6
MRFIR 600 30 F	600	157	42	55	2.1
MRFIR 750 30 F	750	157	42	55	2.7
MRFIR 900 30 F	900	157	42	55	3.2

Cat. Nos. given in the table are for inside risers. For outside risers substitute MRFOR for MRFIR. All fixed risers radius = 260 mm

Note: 50 mm wide not available in D finish

Dimensions

X = Length of fitting from each end (excluding integral coupler)

Y = Length of fitting from each end (excluding integral coupler)

Z = End extension of inte

Weights

All weights given are in kilograms (kg) and are for hot dip galvanised G finish

To obtain the appropriate component weight in other finishes, multiply the given weight by the following factors :

- Deep galvanised (D) x 1.06
- Stainless steel (S) x 0.94
- Pre-galvanised (PG) x 0.96
- Powder coated (E) x 0.97

Assembly using Swiftclip – inside and outside risers

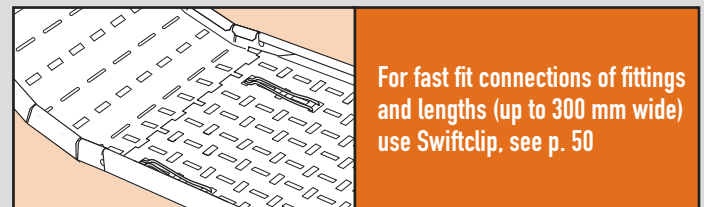

Assembly using fasteners – inside and outside risers

Coupling detail

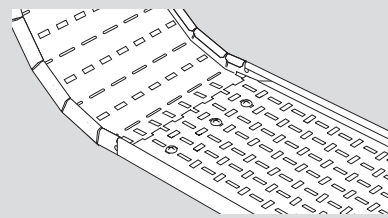

Riser to straight length coupling

Risers have integral couplers which fit into straight lengths whether they have been cut to length or not, without the need for further drilling. Each riser to length joint is secured with M6 x 12 bolts (roofing or pan head), nuts and washers or quick bolt fasteners (Cat. No. QBF), see p. 50. Fasteners are not included

Minimum number of fasteners per joint :

Widths up to 225 = 2

Widths 300 to 600 = 3

Widths 750 and 900 = 4

Fastener finishes

For risers with G, D and PG finishes, fasteners are galvanised or zinc plated

For risers with S finish, fasteners are stainless steel

For risers with E finish, the choice of material for fasteners will depend on the installation environment. For further information, contact us on +44 (0) 345 605 4333

All dimensions (mm) are nominal

→ MRF adjustable risers : see p. 57

Swifts® MRF medium duty fittings

adjustable risers

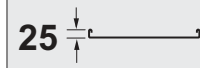

■ Dimensions and weights

The adjustable riser can be used as an inside or outside riser for any angle up to 90°

- Minimum radius = 200 mm
- Maximum radius = 300 mm
- Overall length when flat = 554 mm

Dimensions

Cat. No. MRFAR **W F**

Used as inside riser

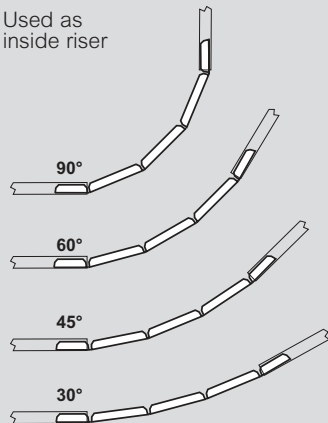

Used as outside riser

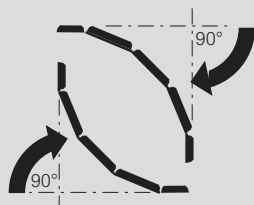
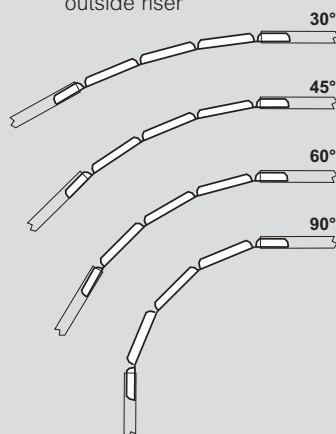

Cat. Nos.	Width	Weight (kg)
MRFAR 50 F	50	0.4
MRFAR 75 F	75	0.5
MRFAR 100 F	100	0.6
MRFAR 150 F	150	0.9
MRFAR 225 F	225	1.2
MRFAR 300 F	300	2.0
MRFAR 450 F	450	3.0
MRFAR 600 F	600	4.1
MRFAR 750 F	750	5.2
MRFAR 900 F	900	6.2

Note

50 mm wide not available in D finish

Weights

All weights given are in kilograms (kg) and are for hot dip galvanised G finish

To obtain the appropriate component weight in other finishes, multiply the given weight by the following factors :

- Deep galvanised (D) x 1.06
- Stainless steel (S) x 0.94
- Pre-galvanised (PG) x 0.96
- Powder coated (E) x 0.97

Key : Replace the letter shown in red with your choice from the following options :

- F** = Finish : **G** (hot dip galvanised after manufacture), **D** (deep galvanised), **PG** (pre-galvanised steel), **S** (stainless steel), **E** (powder coated black RAL 9005)

■ Assembly

As many riser segments as necessary may be inserted into the end of the straight length, thus avoiding the need for cutting

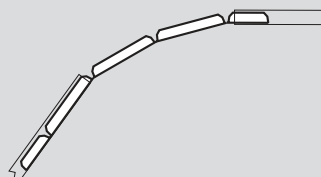

■ Assembly using Swiftclip – adjustable risers

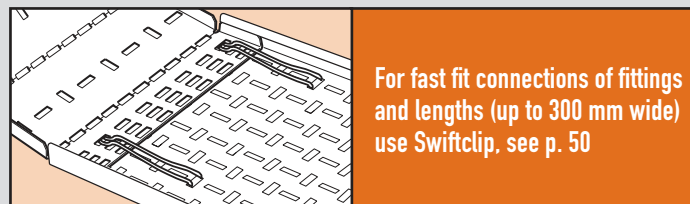

For fast fit connections of fittings and lengths (up to 300 mm wide) use Swiftclip, see p. 50

■ Assembly using fasteners – adjustable risers

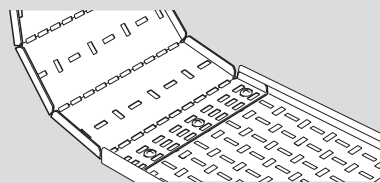

Adjustable riser to straight length coupling

Adjustable risers fit into straight lengths whether they have been cut to lengths or not, without the need for further drilling

Each riser to length joint is secured with M6 x 12 bolts (roofing or pan head), nuts and washers or quick bolt fasteners (Cat. No. QBF), p. 50. Fasteners are not included

Minimum number of fasteners per joint :

- Widths up to 225 = 2
- Widths 300 to 600 = 3
- Widths 750 and 900 = 4

Fastener finishes

For adjustable riser with G, D and PG finishes, fasteners are galvanised or zinc plated

For adjustable riser with S finish, fasteners are stainless steel

For adjustable riser with E finish, the choice of material for fasteners will depend on the installation environment. For further information, contact us on +44 (0) 345 605 4333

All dimensions (mm) are nominal

➔ MRF inside and outside risers : see p. 56

■ Dimensions and weights

The extra long adjustable riser can be used as an inside or outside riser for any angle up to 90°
 Minimum radius = 200 mm
 Maximum radius = 650 mm
 Overall length when flat = 1 087 mm

Dimensions

Cat. No. MRFAXR **W F**

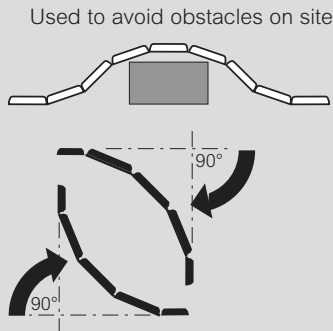
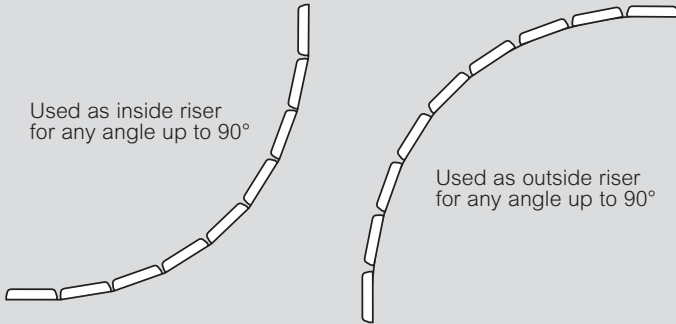

Cat. Nos.	Width	Weight (kg)
MRFAXR 50 F	50	0.7
MRFAXR 75 F	75	1.0
MRFAXR 100 F	100	1.2
MRFAXR 150 F	150	1.7
MRFAXR 225 F	225	2.5
MRFAXR 300 F	300	4.2
MRFAXR 450 F	450	6.2
MRFAXR 600 F	600	8.2
MRFAXR 750 F	750	10.3
MRFAXR 900 F	900	12.4

Note
 50 mm wide not available in D finish

Weights

All weights given are in kilograms (kg) and are for hot dip galvanised G finish
 To obtain the appropriate component weight in other finishes, multiply the given weight by the following factors :

- Deep galvanised (D) x 1.06
- Stainless steel (S) x 0.94
- Pre-galvanised (PG) x 0.96
- Powder coated (E) x 0.97

Key : Replace the letter shown in red with your choice from the following options :

- F** = Finish : **G** (hot dip galvanised after manufacture), **D** (deep galvanised), **PG** (pre-galvanised steel), **S** (stainless steel), **E** (powder coated black RAL 9005)

■ Assembly

As many riser segments as necessary may be inserted into the end of the straight length, thus avoiding the need for cutting

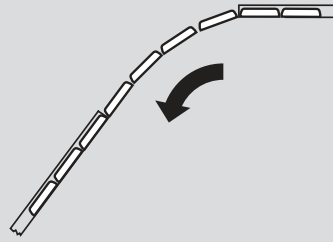

■ Assembly using Swiftclip – extra long adjustable risers

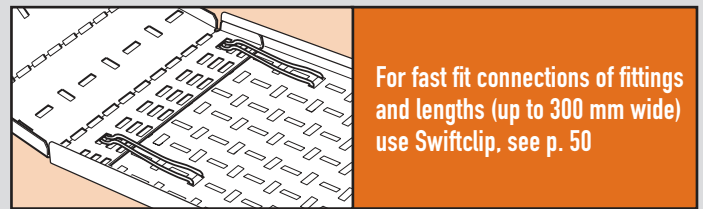

■ Assembly using fasteners – extra long adjustable risers

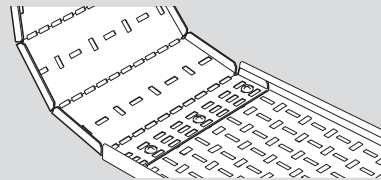

Extra long adjustable riser to straight length coupling

Extra long adjustable risers fit into straight lengths whether they have been cut to length or not, without the need for further drilling
 Each riser to length joint is secured with M6 x 12 bolts (roofing or pan head), nuts and washers or quick bolt fasteners (Cat. No. QBF), p. 50. Fasteners are not included

Minimum number of fasteners per joint :

- Widths up to 225 = 2
- Widths 300 to 600 = 3
- Widths 750 and 900 = 4

Fastener finishes

For adjustable risers with G, D and PG finishes, fasteners are galvanised or zinc plated
 For adjustable risers with S finish, fasteners are stainless steel
 For adjustable risers with E finish, the choice of material for fasteners will depend on the installation environment. For further information, contact us on +44 (0) 345 605 4333

All dimensions (mm) are nominal

MRF inside and outside risers : see p. 56

Swifts® MRF medium duty fittings

equal tees

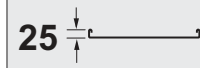

■ Dimensions and weights

Dimensions

Cat. No. MRFT **W F**

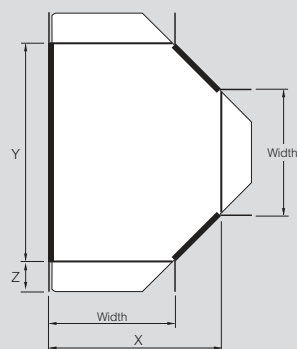

X = Length of fitting from each end (excluding integral coupler)
 Y = Length of fitting from each end (excluding integral coupler)
 Z = End extension of integral coupler

Cat. Nos.	Width	X	Y	Z	Weight (kg)
MRFT 50 F	50	172	295	55	0.6
MRFT 75 F	75	197	320	55	0.8
MRFT 100 F	100	221	344	55	0.9
MRFT 150 F	150	271	394	55	1.3
MRFT 225 F	225	346	469	55	2.0
MRFT 300 F	300	420	542	55	2.8
MRFT 450 F	450	570	692	55	5.7
MRFT 600 F	600	720	842	55	9.0
MRFT 750 F	750	870	992	55	16.4
MRFT 900 F	900	1020	1142	55	21.9

Note

50 mm wide not available in D finish

Weights

All weights given are in kilograms (kg) and are for hot dip galvanised G finish

To obtain the appropriate component weight in other finishes, multiply the given weight by the following factors :

- Deep galvanised (D) x 1.06
- Stainless steel (S) x 0.94
- Pre-galvanised (PG) x 0.96
- Powder coated (E) x 0.97

■ Assembly using Swiftclip – equal tees

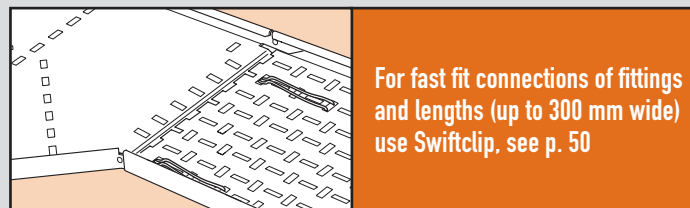

For fast fit connections of fittings and lengths (up to 300 mm wide) use Swiftclip. see p. 50

■ Assembly using fasteners – equal tees

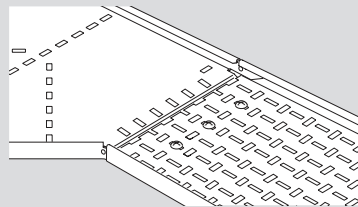

Equal tee to straight length coupling

Equal tees have integral couplers which fit into straight lengths whether they have been cut to length or not, without the need for further drilling. Each equal tee to length joint is secured with M6 x 12 bolts (roofing or pan head), nuts and washers or quick bolt fasteners (Cat. No. QBF), see p. 50. Fasteners are not included.

Minimum number of fasteners per joint :

- Widths up to 225 = 2
- Widths 300 to 600 = 3
- Widths 750 and 900 = 4

Fastener finishes

For equal tees with G, D and PG finishes, fasteners are galvanised or zinc plated.

For equal tees with S finish, fasteners are stainless steel.

For equal tees with E finish, the choice of material for fasteners will depend on the installation environment. For further information, contact us on +44 (0) 345 605 4333.

Minimum bend radius for cables

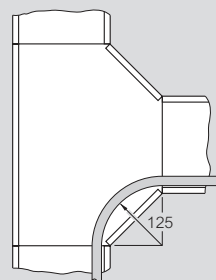

Minimum cable radius = 125 mm

Key : Replace the letter shown in red with your choice from the following options :

- F** = Finish : **G** (hot dip galvanised after manufacture), **D** (deep galvanised), **PG** (pre-galvanised steel), **S** (stainless steel), **E** (powder coated black RAL 9005)

All dimensions (mm) are nominal

➔ MRF unequal tees : see p. 60-61



■ Dimensions and weights

Dimensions

Cat. No. MRFUT **W B F**

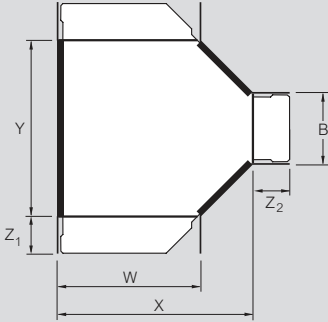

X = Length of fitting from each end (excluding integral coupler)
 Y = Length of fitting from each end (excluding integral coupler)
 Z₁ = End extension of integral coupler
 Z₂ = End extension of integral coupler

Note

50 mm wide not available in D finish

Width (W)	Width (B)	Cat. Nos.	Dimensions (mm)				Weight (kg)
			X	Y	Z ₁	Z ₂	
50	75	MRFUT 50 75 F	172	320	55	55	0.7
	100	MRFUT 50 100 F	172	344	55	55	0.7
	150	MRFUT 50 150 F	172	394	55	55	0.8
	225	MRFUT 50 225 F	172	469	55	55	1.0
	300	MRFUT 50 300 F	172	542	55	55	1.2
	450	MRFUT 50 450 F	172	692	55	55	2.0
	600	MRFUT 50 600 F	172	842	55	55	2.4
	750	MRFUT 50 750 F	172	992	55	55	2.9
	900	MRFUT 50 900 F	172	1 142	55	55	3.4
75	50	MRFUT 75 50 F	197	294	55	55	0.7
	100	MRFUT 75 100 F	197	344	55	55	0.8
	150	MRFUT 75 150 F	197	394	55	55	1.0
	225	MRFUT 75 225 F	197	469	55	55	1.2
	300	MRFUT 75 300 F	197	542	55	55	1.4
	450	MRFUT 75 450 F	197	692	55	55	2.2
	600	MRFUT 75 600 F	197	842	55	55	2.7
	750	MRFUT 75 750 F	197	992	55	55	3.3
	900	MRFUT 75 900 F	197	1 142	55	55	3.7
100	50	MRFUT 100 50 F	221	294	55	55	0.8
	75	MRFUT 100 75 F	221	320	55	55	0.9
	150	MRFUT 100 150 F	221	394	55	55	1.1
	225	MRFUT 100 225 F	221	469	55	55	1.3
	300	MRFUT 100 300 F	221	542	55	55	1.5
	450	MRFUT 100 450 F	221	692	55	55	2.4
	600	MRFUT 100 600 F	221	842	55	55	3.0
	750	MRFUT 100 750 F	221	992	55	55	3.7
	900	MRFUT 100 900 F	221	1 142	55	55	4.1
150	50	MRFUT 150 50 F	271	294	55	55	1.0
	75	MRFUT 150 75 F	271	320	55	55	1.1
	100	MRFUT 150 100 F	271	344	55	55	1.1
	225	MRFUT 150 225 F	271	469	55	55	1.6
	300	MRFUT 150 300 F	271	542	55	55	1.8
	450	MRFUT 150 450 F	271	692	55	55	2.9
	600	MRFUT 150 600 F	271	842	55	55	3.5
	750	MRFUT 150 750 F	271	992	55	55	3.8
	900	MRFUT 150 900 F	271	1 142	55	55	4.1

Width (W)	Width (B)	Cat. Nos.	Dimensions (mm)				Weight (kg)
			X	Y	Z ₁	Z ₂	
225	50	MRFUT 225 50 F	346	294	55	55	1.3
	75	MRFUT 225 75 F	346	320	55	55	1.4
	100	MRFUT 225 100 F	346	344	55	55	1.5
	150	MRFUT 225 150 F	346	394	55	55	1.7
	300	MRFUT 225 300 F	346	542	55	55	2.3
	450	MRFUT 225 450 F	346	692	55	55	3.7
	600	MRFUT 225 600 F	346	842	55	55	4.5
	750	MRFUT 225 750 F	346	992	55	55	5.2
	900	MRFUT 225 900 F	346	1 142	55	55	6.0
300	50	MRFUT 300 50 F	420	294	55	55	1.6
	75	MRFUT 300 75 F	420	320	55	55	1.7
	100	MRFUT 300 100 F	420	342	55	55	1.8
	150	MRFUT 300 150 F	420	392	55	55	2.0
	225	MRFUT 300 225 F	420	467	55	55	2.4
	450	MRFUT 300 450 F	420	692	55	55	4.5
	600	MRFUT 300 600 F	420	842	55	55	5.4
	750	MRFUT 300 750 F	420	992	55	55	6.1
	900	MRFUT 300 900 F	420	1 142	55	55	7.1
450	50	MRFUT 450 50 F	570	294	55	55	2.7
	75	MRFUT 450 75 F	570	320	55	55	2.9
	100	MRFUT 450 100 F	570	342	55	55	3.1
	150	MRFUT 450 150 F	570	392	55	55	3.5
	225	MRFUT 450 225 F	570	467	55	55	4.1
	300	MRFUT 450 300 F	570	542	55	55	4.7
	600	MRFUT 450 600 F	570	842	55	55	7.2
	750	MRFUT 450 750 F	570	992	55	55	10.1
	900	MRFUT 450 900 F	570	1 142	55	55	12.6
600	50	MRFUT 600 50 F	720	294	55	55	3.3
	75	MRFUT 600 75 F	720	320	55	55	3.7
	100	MRFUT 600 100 F	720	342	55	55	3.9
	150	MRFUT 600 150 F	720	392	55	55	4.4
	225	MRFUT 600 225 F	720	467	55	55	5.2
	300	MRFUT 600 300 F	720	542	55	55	6.0
	450	MRFUT 600 450 F	720	692	55	55	7.5
	750	MRFUT 600 750 F	720	992	55	55	10.0
	900	MRFUT 600 900 F	720	1 142	55	55	15.6
750	50	MRFUT 750 50 F	870	294	55	55	4.2
	75	MRFUT 750 75 F	870	320	55	55	4.4
	100	MRFUT 750 100 F	870	342	55	55	4.7
	150	MRFUT 750 150 F	870	392	55	55	6.7
	225	MRFUT 750 225 F	870	467	55	55	8.1
	300	MRFUT 750 300 F	870	542	55	55	9.3
	450	MRFUT 750 450 F	870	692	55	55	11.3
	600	MRFUT 750 600 F	870	842	55	55	12.2
	900	MRFUT 750 900 F	870	1 142	55	55	13.8
900	50	MRFUT 900 50 F	1 020	294	55	55	4.9
	75	MRFUT 900 75 F	1 020	320	55	55	5.1
	100	MRFUT 900 100 F	1 020	342	55	55	5.5
	150	MRFUT 900 150 F	1 020	392	55	55	6.2
	225	MRFUT 900 225 F	1 020	467	55	55	7.2
	300	MRFUT 900 300 F	1 020	542	55	55	11.6
450	MRFUT 900 450 F	1 020	692	55	55	13.6	
600	MRFUT 900 600 F	1 020	842	55	55	16.0	
750	MRFUT 900 750 F	1 020	992	55	55	17.0	

Key : Replace the letter shown in red with your choice from the following options :

- F = Finish : **G** (hot dip galvanised after manufacture),
- D** (deep galvanised), **PG** (pre-galvanised steel),
- S** (stainless steel), **E** (powder coated black RAL 9005)

Swifts® MRF medium duty fittings

unequal tees (continued)

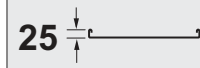

■ Dimensions and weights (continued)

Weights

All weights given are in kilograms (kg) and are for hot dip galvanised G finish

To obtain the appropriate component weight in other finishes, multiply the given weight by the following factors :

Deep galvanised (D)	x 1.06
Stainless steel (S)	x 0.94
Pre-galvanised (PG)	x 0.96
Powder coated (E)	x 0.97

■ Assembly using Swiftclip – unequal tees

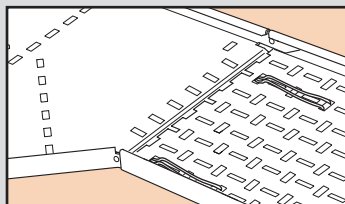

For fast fit connections of fittings and lengths (up to 300 mm wide) use Swiftclip, see p. 50

■ Assembly using fasteners – unequal tees

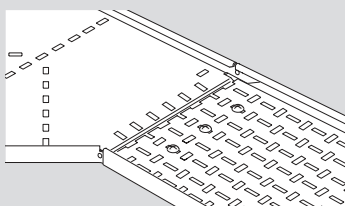

Unequal tee to straight length coupling

Unequal tees have integral couplers which fit into straight lengths whether they have been cut to length or not, without the need for further drilling

Each unequal tee to length joint is secured with M6 x 12 bolts (roofing or pan head), nuts and washers or quick bolt fasteners (Cat. No. QBF), p. 50. Fasteners are not included

Minimum number of fasteners per joint :

Widths up to 225	= 2
Widths 300 to 600	= 3
Widths 750 and 900	= 4

Fastener finishes

For unequal tees with G, D and PG finishes, fasteners are galvanised or zinc plated

For unequal tees with S finish, fasteners are stainless steel

For unequal tees with E finish, the choice of material for fasteners will depend on the installation environment. For further information, contact us on +44 (0) 345 605 4333

Minimum bend radius for cables

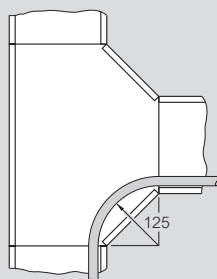

Minimum cable radius = 125 mm

All dimensions (mm) are nominal

➔ MRF equal tees : see p. 59

■ Dimensions and weights

Dimensions

Cat. No. MRFX **W F**

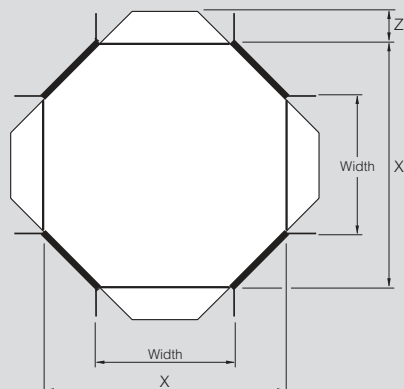

X = Length of fitting from each end (excluding integral coupler)

Z = End extension of integral coupler

Cat. Nos.	Width	X	Z	Weight (kg)
MRFX 50 F	50	295	55	0.8
MRFX 75 F	75	320	55	1.0
MRFX 100 F	100	344	55	1.2
MRFX 150 F	150	394	55	1.7
MRFX 225 F	225	469	55	2.4
MRFX 300 F	300	542	55	3.3
MRFX 450 F	450	692	55	6.9
MRFX 600 F	600	842	55	10.2
MRFX 750 F	750	992	55	18.4
MRFX 900 F	900	1 142	55	23.5

Note

50 mm wide not available in D finish

Weights

All weights given are in kilograms (kg) and are for hot dip galvanised G finish

To obtain the appropriate component weight in other finishes, multiply the given weight by the following factors :

Deep galvanised (D)	x 1.06
Stainless steel (S)	x 0.94
Pre-galvanised (PG)	x 0.96
Powder coated (E)	x 0.97

Key : Replace the letter shown in red with your choice from the following options :

- F** = Finish : **G** (hot dip galvanised after manufacture), **D** (deep galvanised), **PG** (pre-galvanised steel), **S** (stainless steel), **E** (powder coated black RAL 9005)

■ Assembly using Swiftclip – 4 way crosspieces

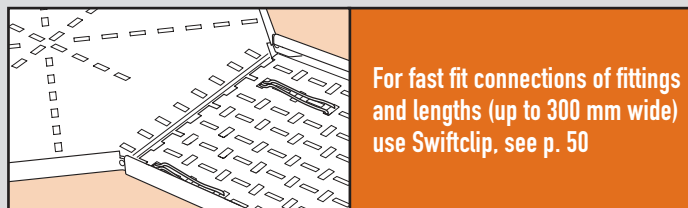

■ Assembly using fasteners – 4 way crosspieces

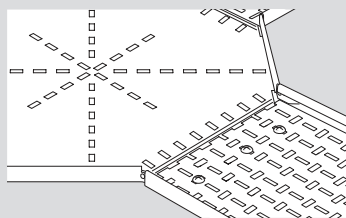

4 way crosspiece to straight length coupling

Crosspieces have integral couplers which fit into straight lengths whether they have been cut to length or not, without the need for further drilling

Each crosspiece to length joint is secured with M6 x 12 bolts (roofing or pan head), nuts and washers or quick bolt fasteners (Cat. No. QBF), p. 50. Fasteners are not included

Minimum number of fasteners per joint :

Widths up to 225 = 2

Widths 300 to 600 = 3

Widths 750 and 900 = 4

Fastener finishes

For crosspieces with G, D and PG finishes, fasteners are galvanised or zinc plated

For crosspieces with S finish, fasteners are stainless steel

For crosspieces with E finish, the choice of material for fasteners will depend on the installation environment. For further information, contact us on +44 (0) 345 605 4333

Minimum bend radius for cables

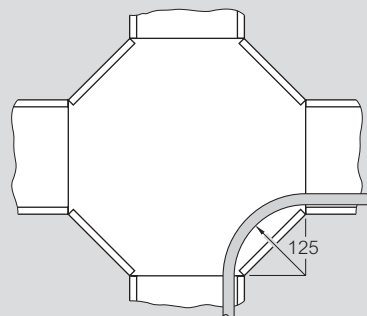

Minimum cable radius = 125 mm

All dimensions (mm) are nominal

Swifts® MRF medium duty fittings

straight reducers

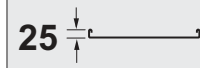

■ Dimensions and weights

Dimensions

Cat. No. MRFR **W K F**

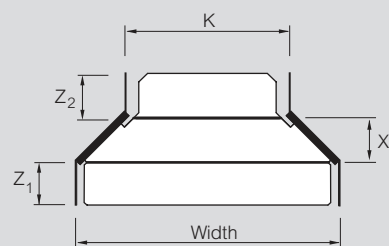

X = Length of fitting from each end (excluding integral coupler)
 Z₁ = End extension of integral coupler
 Z₂ = End extension of integral coupler
 K = Reduced width

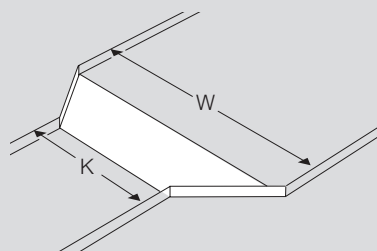

To create the Cat No., add the main run width (W), the reduced run width (K) and the finish (F)

Example :

For a hot dip galvanised reducer reducing from 300 mm to 150 mm : MRFR 300 150 G

Weights

All weights given are in kilograms (kg) and are for hot dip galvanised G finish

To obtain the appropriate component weight in other finishes, multiply the given weight by the following factors :

Deep galvanised (D) x 1.06
 Stainless steel (S) x 0.94
 Pre-galvanised (PG) x 0.96
 Powder coated (E) x 0.97

Width	Width (K)	Cat. Nos.	Dimensions (mm)			Weight (kg)
			X	Z ₁	Z ₂	
75	50	MRFR 75 50 F	100	55	55	0.2
	75	MRFR 75 75 F	100	55	55	0.2
100	50	MRFR 100 50 F	100	55	55	0.2
	75	MRFR 100 75 F	100	55	55	0.2
150	50	MRFR 150 50 F	100	55	55	0.3
	75	MRFR 150 75 F	100	55	55	0.3
225	50	MRFR 225 50 F	150	55	55	0.5
	75	MRFR 225 75 F	100	55	55	0.4
300	100	MRFR 300 100 F	100	55	55	0.4
	150	MRFR 300 150 F	100	55	55	0.4
450	50	MRFR 450 50 F	150	55	55	0.5
	75	MRFR 450 75 F	150	55	55	0.6
600	100	MRFR 600 100 F	100	55	55	0.5
	150	MRFR 600 150 F	100	55	55	0.5
750	225	MRFR 600 225 F	100	55	55	0.6
	300	MRFR 600 300 F	100	55	55	0.6
900	50	MRFR 450 50 F	300	55	55	1.2
	75	MRFR 450 75 F	300	55	55	1.2
450	100	MRFR 450 100 F	300	55	55	1.3
	150	MRFR 450 150 F	150	55	55	0.9
600	225	MRFR 450 225 F	150	55	55	0.9
	300	MRFR 450 300 F	100	55	55	0.8
750	50	MRFR 600 50 F	300	55	55	1.9
	75	MRFR 600 75 F	300	55	55	1.6
900	100	MRFR 600 100 F	300	55	55	1.6
	150	MRFR 600 150 F	300	55	55	1.7
450	225	MRFR 600 225 F	300	55	55	1.8
	300	MRFR 600 300 F	150	55	55	1.2
600	450	MRFR 600 450 F	100	55	55	1.3
	50	MRFR 750 50 F	450	55	55	2.6
750	75	MRFR 750 75 F	450	55	55	2.6
	100	MRFR 750 100 F	450	55	55	2.7
900	150	MRFR 750 150 F	300	55	55	2.7
	225	MRFR 750 225 F	300	55	55	2.8
450	300	MRFR 750 300 F	300	55	55	2.8
	450	MRFR 750 450 F	150	55	55	3.9
600	600	MRFR 750 600 F	100	55	55	4.0
	50	MRFR 900 50 F	450	55	55	3.6
750	75	MRFR 900 75 F	450	55	55	3.9
	100	MRFR 900 100 F	450	55	55	3.9
900	150	MRFR 900 150 F	450	55	55	4.0
	225	MRFR 900 225 F	450	55	55	4.2
450	300	MRFR 900 300 F	300	55	55	5.2
	450	MRFR 900 450 F	300	55	55	5.5
600	600	MRFR 900 600 F	300	55	55	5.9
	750	MRFR 900 750 F	100	55	55	6.2

■ Assembly using Swiftclip – straight reducers

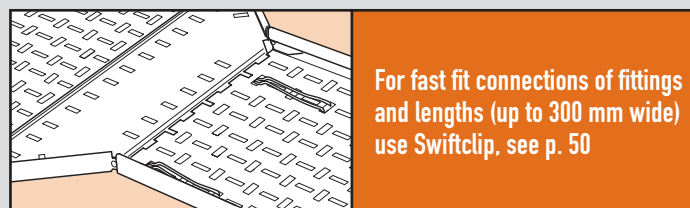

■ Assembly using fasteners – straight reducers

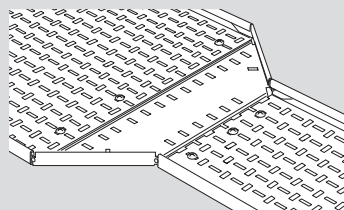

Reducer to straight length coupling

Reducers have integral couplers which fit into straight lengths whether they have been cut to length or not, without the need for further drilling. Each reducer to length joint is secured with M6 x 12 bolts (roofing or pan head), nuts and washers or quick bolt fasteners (Cat. No. QBF), p. 50. Fasteners are not included.

Minimum number of fasteners per joint :

Widths up to 225 = 2
 Widths 300 to 600 = 3
 Widths 750 and 900 = 4

Fastener finishes

For reducers with G, D and PG finishes, fasteners are galvanised or zinc plated

For reducers with S finish, fasteners are stainless steel

For reducers with E finish, the choice of material for fasteners will depend on the installation environment. For further information, contact us on +44 (0) 345 605 4333

All dimensions (mm) are nominal

Key : Replace the letter shown in red with your choice from the following options :

F = Finish : **G** (hot dip galvanised after manufacture),
D (deep galvanised), **PG** (pre-galvanised steel),
S (stainless steel), **E** (powder coated black RAL 9005)

Swifts® SRF heavy duty return flange

straight lengths

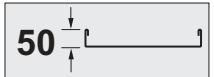

■ Dimensions and weights

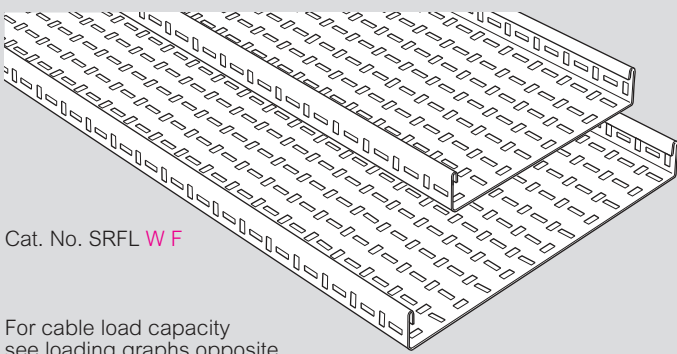

Cat. No. SRFL **WF**

For cable load capacity see loading graphs opposite

■ Dimensions

Standard length 3 m

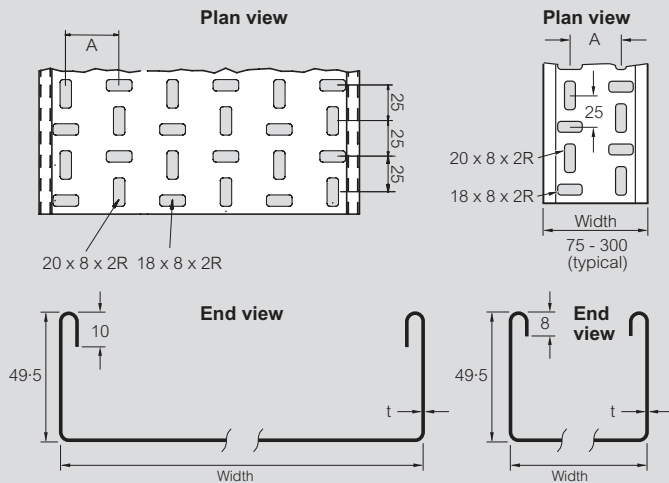

Width (mm)	A (mm)
75	37.50
100	31.75
150 to 900	37.50

R = radius

■ Gauges and weights

The gauge 't' for each cable tray width and finish can vary by product and range

Non-standard gauges and finishes are available to special order, contact us on +44 (0) 345 605 4333

Cat. Nos.	Width (mm)	Weight (kg)	Gauge t (mm)	
			G	PG
SRFL 75 F	75	4.2	0.9	0.9
SRFL 100 F	100	4.4	0.9	0.9
SRFL 150 F	150	6.0	0.9	0.9
SRFL 225 F	225	8.9	1.2	1.2
SRFL 300 F	300	10.8	1.2	1.2
SRFL 450 F	450	17.8	1.2	1.2
SRFL 600 F	600	22.9	1.5	1.4
SRFL 750 F	750	35.9	2.0	2.0
SRFL 900 F	900	42.0	2.0	2.0

All weights given are in kilograms (kg) and are for a 3 m straight length in hot dip galvanised G finish

To obtain the appropriate component weight in other finishes, multiply the given weight by the following factors :

- Deep galvanised (D) x 1.06
- Stainless steel (S) x 0.94
- Pre-galvanised (PG) x 0.96
- Powder coated (E) x 0.97

Sheared steel (particularly stainless steel) does have relatively sharp edges and protective gloves must be worn during handling

■ Loading graphs

Load tests carried out to BS EN 61537 and shown in kg/m

Cable fill figure is the maximum physical load of cables that can be fitted into tray and is based on 1700 kg/m³ as detailed in the BEAMA "Best Practice guide to cable ladder and cable tray systems"

The loads shown on all graphs are the safe recommended maximum loads that can be applied and must include wind, snow and any other external forces in addition to the cable load

The graphs show the maximum load for tray installed at a support spacing within its recommended range

75-300 mm width trays

SRF G SWL 75-300

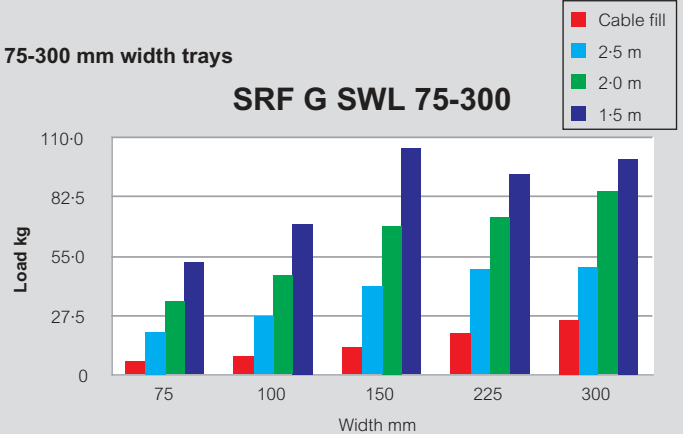

Table shown with results up to 300 mm wide obtained using the Swiftclip

450-900 mm width trays

SRF G SWL 450-900

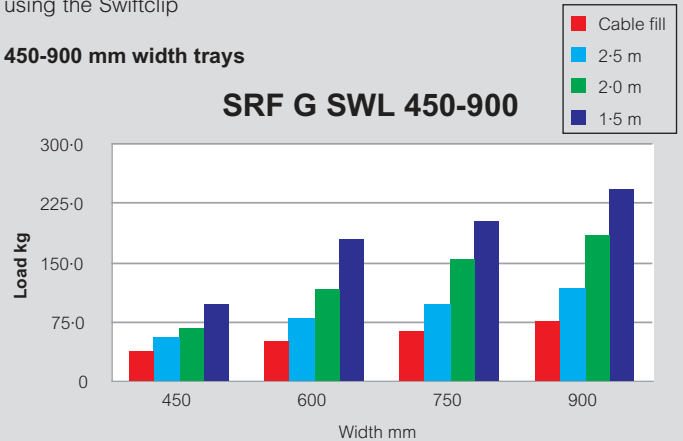

Table shown with results of 450 mm wide and above using Swiftgrips and UF fishplates

For lengths 450 mm wide and greater, the addition of fishplate Cat. No. WF **F** across the underside of the length-to-length joint provides added strength and increases the safe working load, **p. 105**

■ Finishes and standards

Standard stocked finish :

- G** Hot dip galvanised after manufacture to BS EN ISO 1461
- PG** Pre-galvanised steel to BS EN 10346 : 2009 grade DX51D

Additional finishes :

- D** Deep galvanised high silicon steel made from BS EN 10025-5 : 2004 Grade S355JOWP
- S** Stainless steel to BS EN 10088 - 2 grade 1.4404 (equivalent to 316L31)
- E** Powder coated black RAL 9005

All dimensions (mm) are nominal

Key : Replace the letter shown in red with your choice from the following options :

- F** = Finish : **G** (hot dip galvanised after manufacture), **D** (deep galvanised), **PG** (pre-galvanised steel), **S** (stainless steel), **E** (powder coated black RAL 9005)

Coupler sets and fixing options : see p. 65-68

Fishplates : see p. 105

Swifts® SRF straight length to straight length coupling

standard couplers and Swiftclip / Swiftgrip

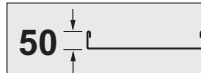

Standard couplers and Swiftclip / Swiftgrip

Couplers are required for joining together SRF straight lengths
SRFC standard couplers are supplied in pairs.

2 x Swiftclips are required for each coupling and are used with tray widths up to and including 300 mm. For 450 mm to 900 mm tray, use Swiftgrip (2 per coupling)

Swiftclip and Swiftgrip are supplied in packs of 10

As an alternative coupling method, use standard couplers and quick bolt fasteners (Cat. No. QBF) and a tool, see p. 66, or standard couplers and fasteners, see p. 66-67

Installation using Swiftclip - 75 mm to 300 mm wide tray

For 75 - 300 mm wide SRF tray
Cat. No. SRFC **F**
and Swiftclip

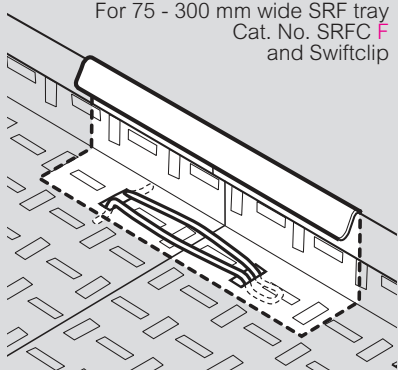

Standard couplers		Swiftclip	
Cat. No.	Tray range	Cat. Nos.	Finish
SRFC F	SRF	SCLPG	PG
		SCLG	G

Assembly using Swiftclip

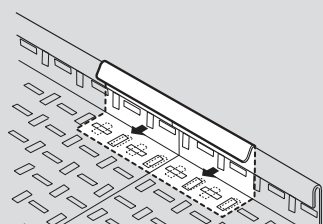

1. Locate coupler across underside of tray joint

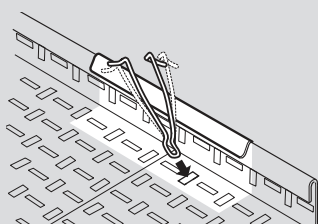

2. Insert joggled head of clip where tray and coupler align

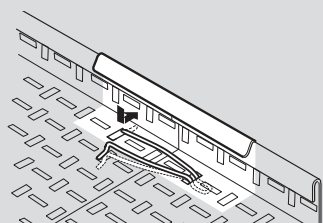

3. Clip leg nearest tray wall into slot on other tray bed

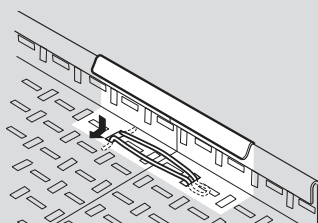

4. The second leg is pushed towards the wall of the tray and pushed home into the same slot

Repeat process on the other side of the tray, fitting the clip in the opposite direction

Ensure:

1. Head and feet of clip are clamping through tray and coupler
2. Clip should span across the joint

Installation using Swiftgrip

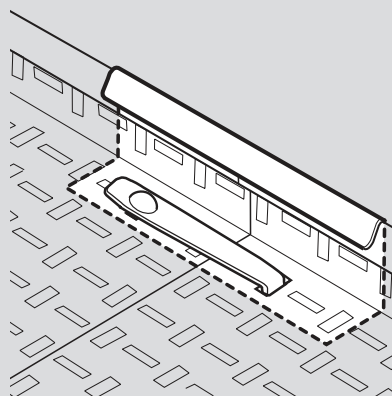

Swiftgrip Cat. No.	For tray finishes
SGR	PG and G

Assembly using Swiftgrip

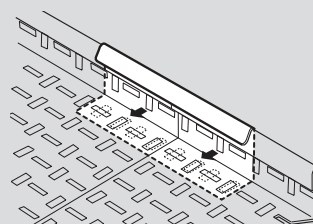

1. Locate coupler across underside of tray joint

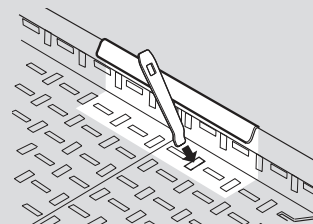

2. Insert joggled head of grip where tray and coupler align

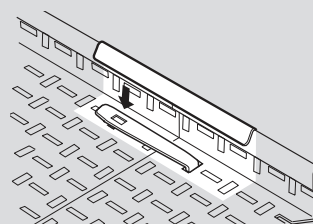

3. Lie length of grip flat against tray bed

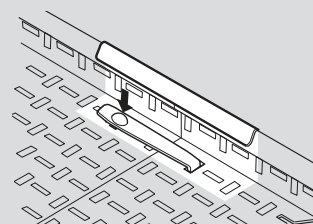

4. Insert QBF into top of Swiftgrip and secure bolt underneath

Repeat process on the other side of the tray, fitting the grip in the opposite direction

Ensure:

1. Head and bolt of grip are clamping through tray and coupler
2. Grip should span across the joint

All dimensions (mm) are nominal

Key : Replace the letter shown in red with your choice from the following options :

- F** = Finish : **G** (hot dip galvanised after manufacture),
D (deep galvanised), **PG** (pre-galvanised steel),
S (stainless steel), **E** (powder coated)

Swifts® SRF straight length to straight length coupling

standard couplers and Swiftclip / Swiftgrip (continued)
standard couplers and quick bolt fasteners

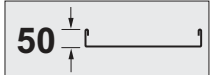

■ Dimensions and weights

SRFC (for 75 mm to 900 mm wide tray)

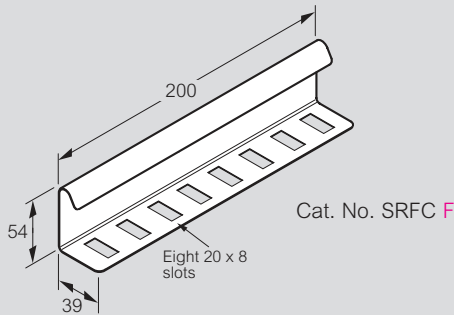

Cat. Nos.	Weight (kg)
SRFC F	0.4 pair

Swiftclip (for 50 mm to 300 mm wide tray)

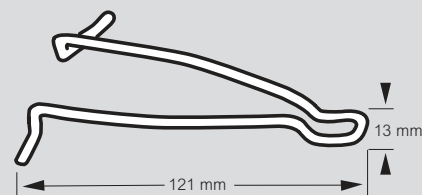

Cat. Nos.	Pack
SCLPG	10
SCLG	10

Swiftgrip

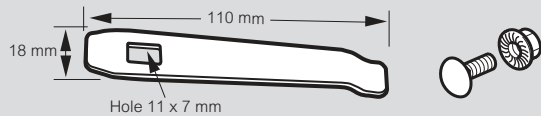

Cat. No.	Pack
SGR	10

Weights

All weights given are in kilograms (kg) and are for hot dip galvanised G finish
To obtain the appropriate component weight in other finishes, multiply the given weight by the following factors :

Deep galvanised (D)	x 1.06
Stainless steel (S)	x 0.94
Pre-galvanised (PG)	x 0.96
Powder coated (E)	x 0.97

■ Standard couplers and quick bolt fasteners

Compared with conventional nuts and bolts, quick bolt fasteners are a stronger, faster, easier and safer method of joining together tray
Square-shafted quick bolts lock firmly into position before fixing. The nuts, which have integral washers and a serrated edge to reduce slip and improve earthing, can then be easily tightened using a power tool
Supplied in packs containing 100 quick bolt fasteners and a FREE power tool attachment

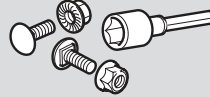

■ Installation

Typical installation as per standard couplers, replacing nuts, bolts and washers with quick bolt fasteners

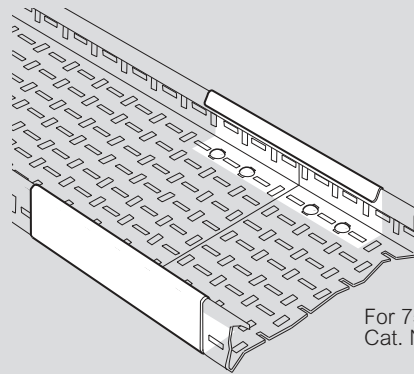

For 75 - 900 mm wide SRF tray
Cat. No. SRFC F

■ Assembly

Bring together two lengths and fit a coupler on the outside of adjacent flanges at both sides of the tray joint

Locate the coupler and insert bolts through aligning slots in each tray bed and coupler as shown and secure with nuts

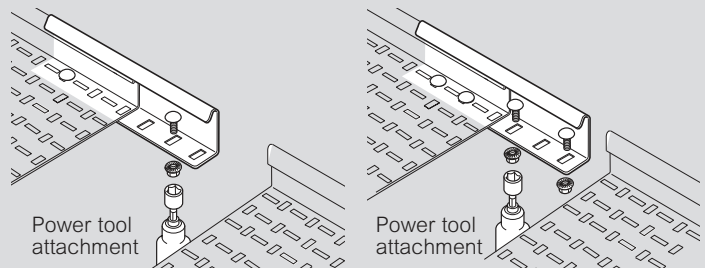

Tray widths up to 225 mm
Two quick bolt fasteners per coupler

Tray widths 300 mm and above
Four quick bolt fasteners per coupler

Quick bolt fasteners

Cat. Nos.	Pack	Size (mm)	Finish
QBF	100	M6 x 12	Dacromet
QBFS	100	M6 x 12	Stainless steel

For G, PG and S finish

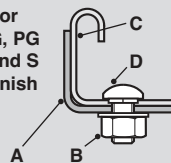

- A Coupler
- B M6 flange nut
- C Straight length
- D M6 coach bolt

For coupler dimensions see above left

Key : Replace the letter shown in red with your choice from the following options :

F = Finish : G (hot dip galvanised after manufacture),
D (deep galvanised), PG (pre-galvanised steel),
S (stainless steel), E (powder coated)

All dimensions (mm) are nominal

➔ Straight lengths : see p. 64

Swifts® SRF straight length to straight length coupling

standard couplers and standard fasteners

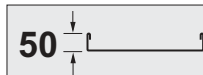

Standard couplers and standard fasteners

Couplers are required for joining together SRF straight lengths or cut lengths of tray
SRFC standard couplers are supplied in pairs
Supplied without fasteners – use M6 nuts, bolts and washers (see opposite)

Installation (typical)

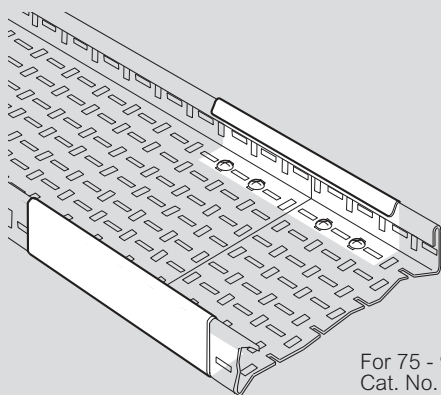

For 75 - 900 mm wide SRF tray
Cat. No. SRFC F

Cat. Nos.	Tray range
SRFC F	SRF

Assembly

For 75 - 900 mm wide SRF tray

Bring together two lengths and fit a coupler on the outside of adjacent flanges at both sides of the tray joint

Locate the coupler as shown and insert two roofing bolts through aligning slots in each tray bed and coupler (four bolts per coupler), and secure with roofing washers and nuts

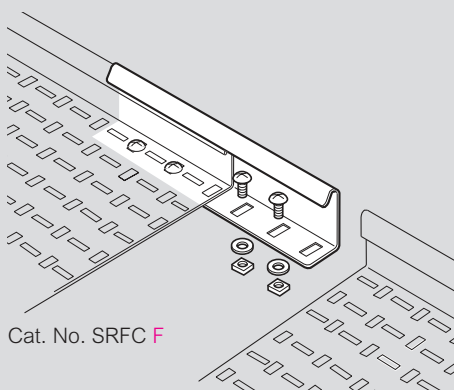

Cat. No. SRFC F

Assembly (continued)

Roofing bolts

For G and PG finish

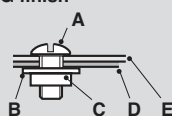

For S finish

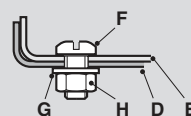

- A M6 x 12 roofing bolt
- B Roofing washer
- C M6 square nut
- D Fitting
- E Straight length
- F M6 x 12 pan head screw
- G M6 form A washer
- H M6 hexagon nut

Fasteners

For G, D and PG finish

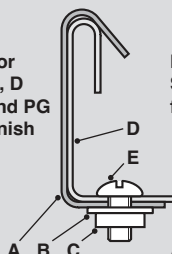

For S finish

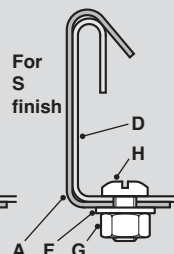

- A Coupler
- B Roofing washer
- C M6 square nut
- D Straight length
- E M6 x 12 roofing bolt
- F M6 form A washer
- G M6 hexagon nut
- H M6 x 12 pan head screw

Fastener finish

For lengths and fittings with G, D and PG finishes, fasteners are galvanised or zinc plated. For trays and fittings with S finish, fasteners are corrosion resistant stainless Grade A470

For lengths and fittings with E finish, the choice of material for fasteners will depend on the installation environment - contact us on +44 (0) 345 605 4333

Note

For quick bolt fasteners, see p. 66

Dimensions and weights

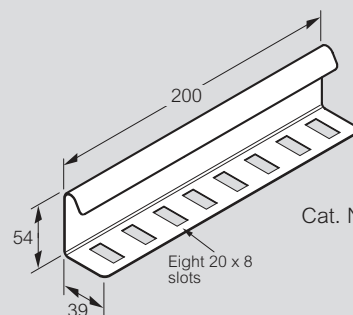

Cat. No. SRFC F

Cat. Nos.	Weight (kg)
SRFC F	0.4 pair

Weights

All weights given are in kilograms (kg) and are for hot dip galvanised G finish

To obtain the appropriate component weight in other finishes, multiply the given weight by the following factors :

Pre-galvanised (PG) x 0.96

All dimensions (mm) are nominal

→ Straight lengths : see p. 64

Swifts® SRF straight length to fitting coupling

using Swiftclip or fasteners

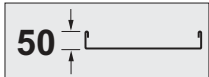

■ Straight length to fitting coupling using Swiftclip – 75 mm to 300 mm wide tray

Cable tray fittings must be properly supported. The ideal location for supports is shown in step 2, i.e. 150 mm from the fitting to length joint. For further details see Design Notes, Recommended Support Locations, p. 132

1 Where necessary re-align the fitting flange tabs from their transit position to their installation position

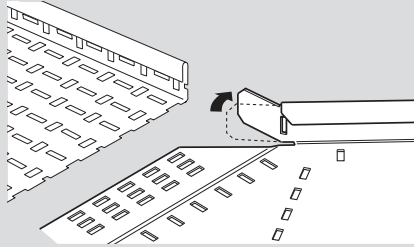

2 When a straight length of cable tray has to be cut back to accept a fitting, always fit the uncut end to the adjacent straight length; the cut end should be connected to the fitting

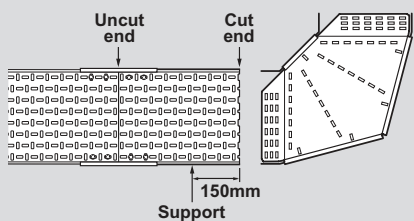

3 Offer the fitting at an angle to the straight length and locate, ensuring that the joggled fishplate fits under the tray bed and the flange tabs slide inside the length flanges

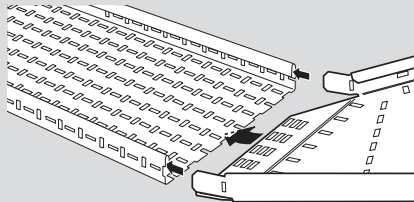

4 Insert joggled head of clip through slots in the tray bed into aligning slots in the fitting fishplate, then clip legs into slot on tray bed

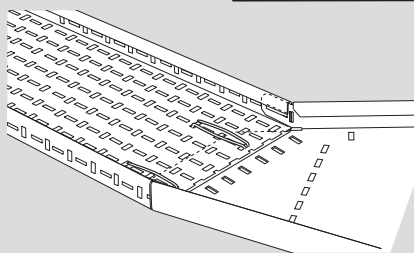

5 Ensure head of clip is clamping through tray and fitting

■ Straight length to fitting coupling using fasteners

Cable tray fittings must be properly supported. The ideal location for supports is shown in step 2, i.e. 150 mm from the fitting to length joint. For further details see Design Notes, Recommended Support Locations, p. 132

1 Where necessary re-align the fitting flange tabs from their transit position to their installation position

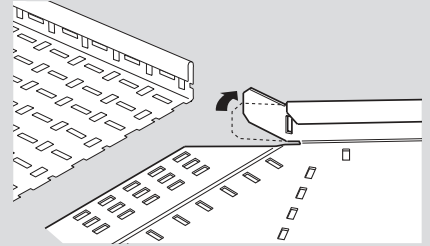

2 When a straight length of cable tray has to be cut back to accept a fitting, always fit the uncut end to the adjacent straight length; the cut end should be connected to the fitting

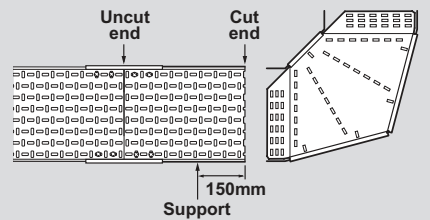

3 Offer the fitting at an angle to the straight length and locate, ensuring that the joggled fishplate fits under the tray bed and the flange tabs slide inside the length flanges

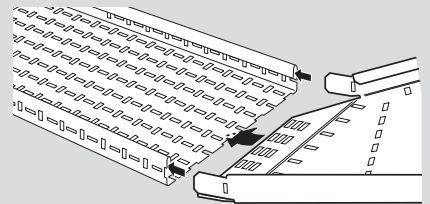

4 Insert roofing bolts or QBF through slots in the tray bed in to aligning slots in the fitting fishplate and secure with roofing washers and nuts

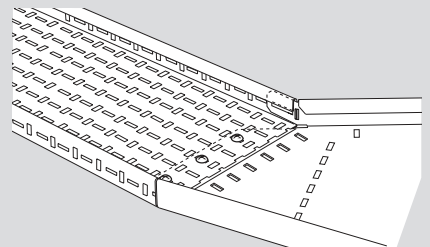

Note

Fasteners stated are for D, G and PG finishes
For lengths and fittings with S finish use fasteners listed below

Fasteners

Minimum number of fasteners per joint (not included) :
Widths up to 225 = 2
Widths 300 to 600 = 3
Widths 750 and 900 = 4

Roofing bolts

For G and PG finish

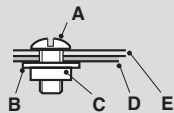

For S finish

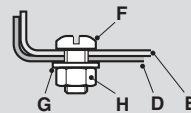

- A M6 x 12 roofing bolt
- B Roofing washer
- C M6 square nut
- D Fitting
- E Straight length
- F M6 x 12 pan head screw
- G M6 form A washer
- H M6 hexagon nut

Quick bolt fasteners

For G, PG and S finish

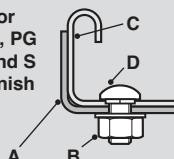

- A Coupler
- B M6 flange nut
- C Straight length
- D M6 coach bolt

Fastener finish

For lengths and fittings with G, D and PG finishes, fasteners are galvanised or zinc plated. For trays and fittings with S finish, fasteners are corrosion resistant stainless Grade A470
For lengths and fittings with E finish, the choice of material for fasteners will depend on the installation environment - contact us on +44 (0) 345 605 4333

Key : Replace the letter shown in red with your choice from the following options :

- F = Finish : G (hot dip galvanised after manufacture), D (deep galvanised), PG (pre-galvanised steel), S (stainless steel), E (powder coated)

All dimensions (mm) are nominal

→ Straight lengths : see p. 64

Swifts® SRF heavy duty fittings

universal bracket and fishplate

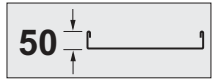

■ Universal bracket

The universal bracket can be easily folded at one or more of the 9 predetermined points. By overfolding a couple of times, the bracket can be split, for example on the centre line to make a hinged coupler or in between the outer flanges if the length of the bracket needs to be reduced

The square hole is provided to locate the shoulder of the quick bolt fastener – this side should be facing inwards towards the tray to avoid snagging cables

The pitch between each fold point is designed to match up with the Swifts range of SRF cable tray systems

By using different configurations the bracket can be folded to create numerous functions on-site, examples of which are shown below

Cat. No. SRFUB F

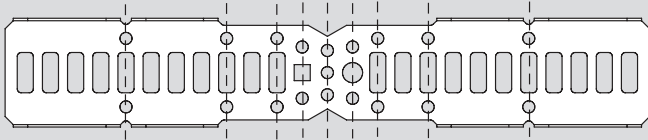

■ Installation (typical)

Side dropout

Tee

Bend

Riser

Flange assembly

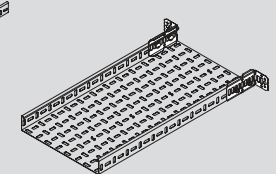
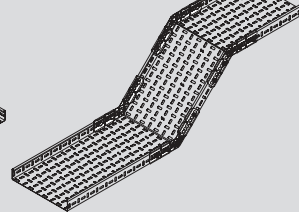
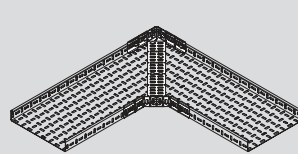
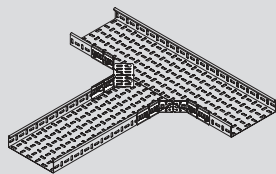
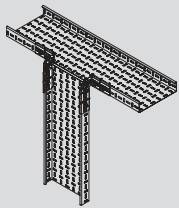

■ Dimensions

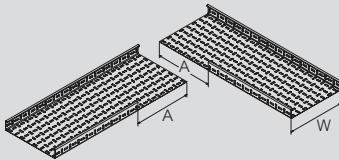

Above dimensions are for 90° bend with overlap joint

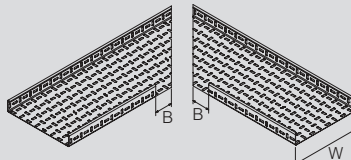

Above dimensions are for 90° bend with diagonal joint. Diagonal cuts are 45°

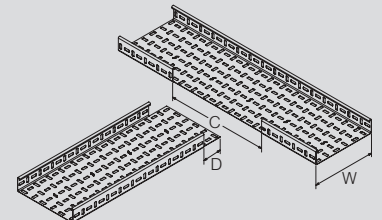

Note 1 : Dimensions are for tee with fishplate joint
Note 2 : For overlap joint tee use 'D' + 50

Cat. Nos.	Width (W)	Overlap A	Diagonal B	Tee	
				C	D
SRFL 75 F	75	80	85	220	75
SRFL 100 F	100	105	85	245	75
SRFL 150 F	150	155	85	295	75
SRFL 225 F	225	230	85	370	75
SRFL 300 F	300	305	85	445	75

■ Handed and straight reducer configurations

Figures show approximated reduced width

Left or right handed reducers are not currently available as a standard factory fabricated fitting

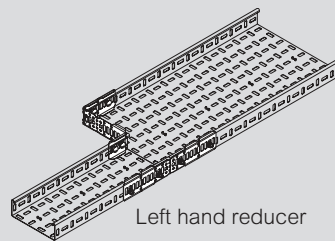

Left hand reducer

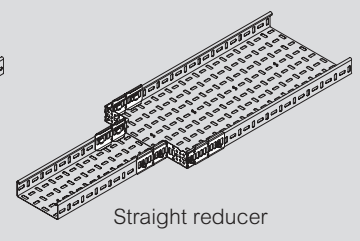

Straight reducer

SRFL

Smaller Size	75 mm		100 mm		150 mm		225 mm		300 mm		450 mm		600 mm		750 mm	
	Handed	Straight	Handed	Straight	Handed	Straight	Handed	Straight	Handed	Straight	Handed	Straight	Handed	Straight	Handed	Straight
100 mm	25	12	–	–	–	–	–	–	–	–	–	–	–	–	–	–
150 mm	75	37	50	25	–	–	–	–	–	–	–	–	–	–	–	–
225 mm	150	75	125	62	75	37	–	–	–	–	–	–	–	–	–	–
300 mm	–	112	200	100	150	75	75	37	–	–	–	–	–	–	–	–
450 mm	–	–	–	175	–	150	–	112	150	75	–	–	–	–	–	–
600 mm	–	–	–	–	–	–	–	187	–	150	150	75	–	–	–	–
750 mm	–	–	–	–	–	–	–	–	–	–	150	150	75	–	–	–
900 mm	–	–	–	–	–	–	–	–	–	–	–	–	150	150	75	–

All dimensions (mm) are nominal

Swifts® SRF heavy duty fittings

flat bends – 90°, 60°, 45° and 30°

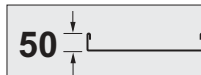

■ 90° flat bends – dimensions and weights

Cat. No. SRFB **W F**

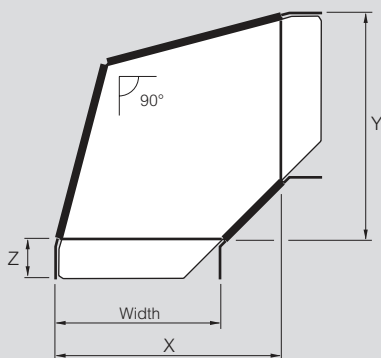

Cat. Nos.	Width	X	Y	Z	Weight (kg)
SRFB 75 F	75	197	197	55	0.6
SRFB 100 F	100	221	221	55	0.8
SRFB 150 F	150	272	272	55	1.0
SRFB 225 F	225	345	345	55	1.5
SRFB 300 F	300	420	420	55	2.6
SRFB 450 F	450	568	568	55	4.3
SRFB 600 F	600	718	718	55	6.4
SRFB 750 F	750	860	860	55	12.4
SRFB 900 F	900	1018	1018	55	16.6

Also consider the versatile adjustable bend for widths 75 mm - 300 mm, p. 72-73

■ 60° flat bends – dimensions and weights

Cat. No. SRFB **W 60 F**

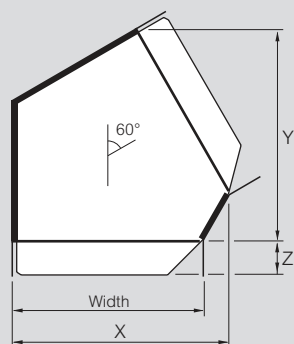

Cat. Nos.	Width	X	Y	Z	Weight (kg)
SRFB 75 60 F	75	133	169	55	0.6
SRFB 100 60 F	100	158	191	55	0.6
SRFB 150 60 F	150	208	234	55	0.8
SRFB 225 60 F	225	283	299	55	1.2
SRFB 300 60 F	300	358	364	55	2.0
SRFB 450 60 F	450	508	493	55	3.4
SRFB 600 60 F	600	658	623	55	5.2
SRFB 750 60 F	750	808	753	55	9.4
SRFB 900 60 F	900	958	882	55	12.5

Also consider the versatile adjustable bend for widths 75 mm - 300 mm, p. 72-73

■ 45° flat bends – dimensions and weights

Cat. No. SRFB **W 45 F**

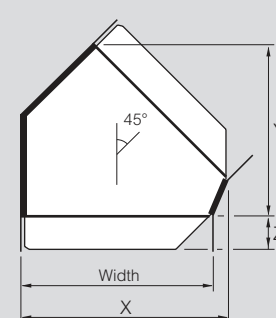

Cat. Nos.	Width	X	Y	Z	Weight (kg)
SRFB 75 45 F	75	108	138	55	0.4
SRFB 100 45 F	100	133	156	55	0.4
SRFB 150 45 F	150	183	191	55	0.6
SRFB 225 45 F	225	258	244	55	0.9
SRFB 300 45 F	300	333	297	55	1.5
SRFB 450 45 F	450	482	402	55	2.5
SRFB 600 45 F	600	632	508	55	3.9
SRFB 750 45 F	750	782	614	55	7.0
SRFB 900 45 F	900	932	720	55	9.4

Also consider the versatile adjustable bend for widths 75 mm - 300 mm, p. 72-73

■ 30° flat bends – dimensions and weights

Cat. No. SRFB **W 30 F**

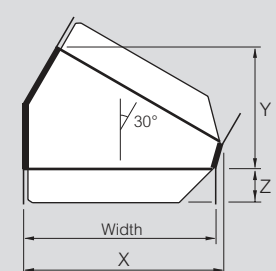

Cat. Nos.	Width	X	Y	Z	Weight (kg)
SRFB 75 30 F	75	88	98	55	0.3
SRFB 100 30 F	100	113	110	55	0.3
SRFB 150 30 F	150	163	135	55	0.4
SRFB 225 30 F	225	238	173	55	0.6
SRFB 300 30 F	300	313	210	55	1.1
SRFB 450 30 F	450	463	285	55	1.8
SRFB 600 30 F	600	613	360	55	2.7
SRFB 750 30 F	750	763	435	55	5.0
SRFB 900 30 F	900	913	510	55	6.6

Also consider the versatile adjustable bend for widths 75 mm - 300 mm, p. 72-73

Key : Replace the letter shown in red with your choice from the following options :

- F** = Finish : **G** (hot dip galvanised after manufacture), **D** (deep galvanised), **PG** (pre-galvanised steel), **S** (stainless steel), **E** (powder coated black RAL 9005)

All dimensions (mm) are nominal

➔ SRF adjustable bends : see p. 72-73

Swifts® SRF heavy duty fittings

flat bends – 90°, 60°, 45° and 30° (continued)



■ Dimensions and weights – flat bends 90°, 60°, 45° and 30°

Dimensions

X = Length of fitting from each end (excluding integral coupler)

Y = Length of fitting from each end (excluding integral coupler)

Z = End extension of integral coupler

Weights

All weights given are in kilograms (kg) and are for hot dip galvanised G finish

To obtain the appropriate component weight in other finishes, multiply the given weight by the following factors :

Deep galvanised (D)	x 1.06
Stainless steel (S)	x 0.94
Pre-galvanised (PG)	x 0.96
Powder coated (E)	x 0.97

■ Assembly using Swiftclip – flat bends 90°, 60°, 45° and 30°

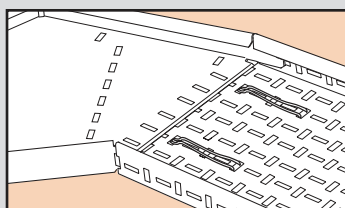

For fast fit connections of fittings and lengths (up to 300 mm wide) use Swiftclip, see p. 68

■ Assembly using fasteners – flat bends 90°, 60°, 45° and 30°

Coupling detail – 90°

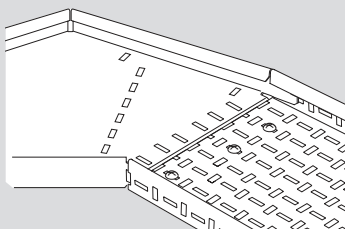

Coupling detail – 60°, 45° and 30°

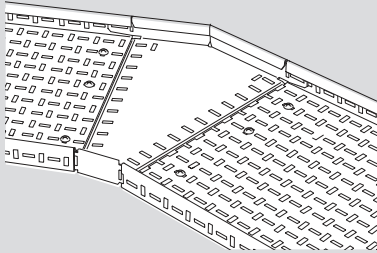

Flat bend to straight length coupling

Flat bends have integral couplers which fit into straight lengths whether they have been cut to length or not, without the need for further drilling

Each flat bend to length joint is secured with M6 x 12 bolts (roofing or pan head), nuts and washers or quick bolt fasteners (Cat. No. QBF), p. 68. Fasteners are not included

Minimum number of fasteners per joint :

Widths up to 225	= 2
Widths 300 to 600	= 3
Widths 750 and 900	= 4

Fastener finishes

For flat bends with G, D and PG finishes, fasteners are galvanised or zinc plated. For flat bends with S finish, fasteners are stainless steel. For flat bends with E finish, the choice of material for fasteners will depend on the installation environment. For further information, contact us on +44 (0) 345 605 4333

Key : Replace the letter shown in red with your choice from the following options :

F = Finish :	G (hot dip galvanised after manufacture),
	D (deep galvanised), PG (pre-galvanised steel),
	S (stainless steel), E (powder coated black RAL 9005)

■ Assembly – flat bends 90°, 60°, 45° and 30° (continued)

Minimum bend radius for cables – flat bends 90°

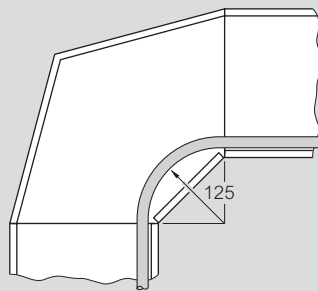

Minimum cable radius = 125 mm

Minimum bend radius for cables – flat bends 60°, 45° and 30°

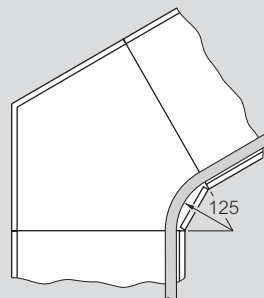

Minimum cable radius = 125 mm

All dimensions (mm) are nominal

➔ SRF adjustable bends : see p. 72-73

■ Dimensions and weights

Cat. No. SRFAB **W F**

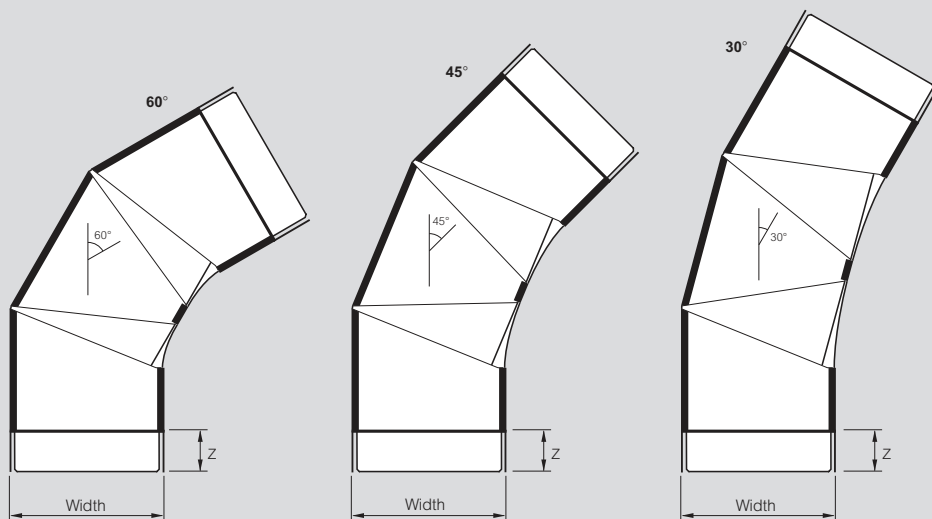

Cat. Nos.	Width	Z	Weight (kg)
SRFAB 75 F	75	55	0.6
SRFAB 100 F	100	55	0.8
SRFAB 150 F	150	55	1.2
SRFAB 225 F	225	55	2.1
SRFAB 300 F	300	55	4.1

For widths 450-900 mm use 60°, 45° and 30° flat bends, **p. 70-71**
 For widths 300 mm and below use adjustable flat bends for all angles up to 90°. Fixed angled flat bends are also available, **p. 70-71**

Dimensions

Z = End extension of integral coupler

Weights

All weights given are in kilograms (kg) and are for hot dip galvanised G finish

To obtain the appropriate component weight in other finishes, multiply the given weight by the following factors :

- Deep galvanised (D) x 1.06
- Stainless steel (S) x 0.94
- Pre-galvanised (PG) x 0.96
- Powder coated (E) x 0.97

Key : Replace the letter shown in red with your choice from the following options :

- F** = Finish : **G** (hot dip galvanised after manufacture), **D** (deep galvanised), **PG** (pre-galvanised steel), **S** (stainless steel), **E** (powder coated black RAL 9005)

All dimensions (mm) are nominal

SRF flat bends : see p. 70-71

Swifts® SRF heavy duty fittings

adjustable flat bends – 75 to 300 mm wide (continued)

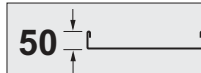

■ Assembly

Adjusting bend to any angle between 30° and 90°

Adjustable flat bends can be adjusted to any angle between 30° and 90°, refer to the diagram opposite

Insert fasteners through both slots **X** in the outer sections of the bed and the associated slots **Z** in the centre section of the bed. Adjust the bendable sections equally until the required angle is formed

Fasteners can also be inserted through the inner flanges when the slots in the fixed outer section flange and the bendable centre section flange align

Setting bend to specific angles

Adjustable flat bends can be set to specific fixed angles or they can be adjusted to any angle between 30° and 90° in increments of 7.5°

Note

When setting the adjustable flat bend to the required angle, ensure that the bendable inner flanges on the centre section engage in the return flanges on the outer sections

Angle (°)	Fastener holes
30	A + A
37.5	A + B
45	B + B
52.5	B + C
60	C + C
67.5	C + D
75	D + D
82.5	D + E
90	E + E

Refer to the table and the diagram below
 Insert fastenings through both slots **X** in the outer sections of the bend and the appropriate holes (**A** to **E**) in the centre section of the bed (2 x M6 fastenings included)
 Fasteners can also be inserted through the inner flanges when the slots in the fixed outer section flange and the bendable centre section flange align

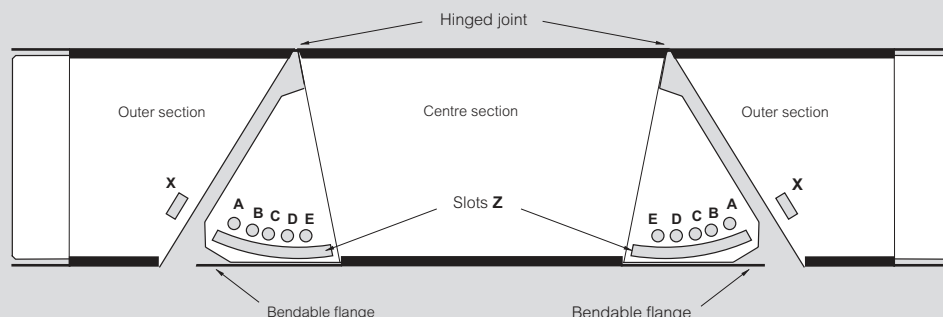

■ Assembly using Swiftclip – adjustable flat bends

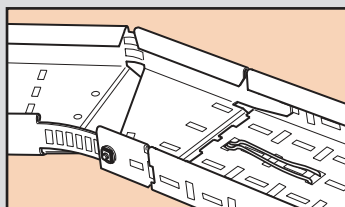

For fast fit connections of fittings and lengths (up to 300 mm wide) use Swiftclip, see p. 68

■ Assembly (continued)

Minimum bend radius for cables

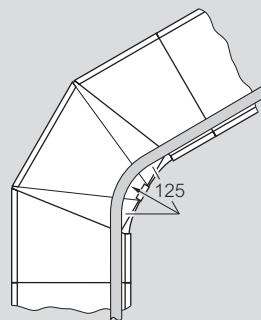

For details on how to set adjustable flat bends to angles, see opposite

■ Assembly using fasteners – adjustable flat bends

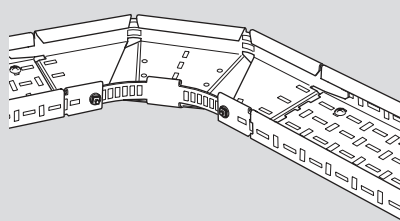

Adjustable flat bend to straight length coupling

Flat bends have integral couplers which fit into straight lengths whether they have been cut to length or not, without the need for further drilling
 Each flat bend to length joint is secured with M6 x 12 bolts (roofing or pan head), nuts and washers or quick bolt fasteners (Cat. No. QBF), p. 68. Fasteners are not included

Minimum number of fasteners per joint :

Widths up to 225 = 2

Width 300 = 3

Fastener finishes

For adjustable flat bends with G, D and PG finishes, fasteners are galvanised or zinc plated

For adjustable flat bends with S finish, fasteners are stainless steel

For adjustable flat bends with E finish, the choice of material for fasteners will depend on the installation environment. For further information, contact us on +44 (0) 345 605 4333

Key : Replace the letter shown in red with your choice from the following options :

F = Finish : **G** (hot dip galvanised after manufacture),
D (deep galvanised), **PG** (pre-galvanised steel),
S (stainless steel), **E** (powder coated black RAL 9005)

All dimensions (mm) are nominal

➔ SRF flat bends : see p. 70-71

Swifts® SRF heavy duty fittings

inside and outside risers – 90°, 60°, 45° and 30°

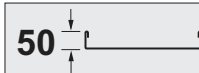

■ 90° inside and outside risers – dimensions and weights

Dimensions

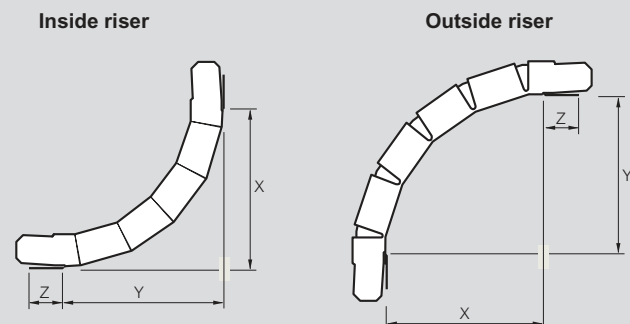

Cat. Nos.	Width	X	Y	Z	Weight (kg)
SRFIR 75 F	75	260	260	55	0.8
SRFIR 100 F	100	260	260	55	0.9
SRFIR 150 F	150	260	260	55	1.2
SRFIR 225 F	225	260	260	55	1.5
SRFIR 300 F	300	260	260	55	2.4
SRFIR 450 F	450	260	260	55	3.4
SRFIR 600 F	600	260	260	55	4.1
SRFIR 750 F	750	260	260	55	6.9
SRFIR 900 F	900	260	260	55	8.2

Cat. Nos. given in the table are for inside risers. For outside risers substitute SRFOR for SRFIR. All fixed risers radius = 260 mm

■ 60° inside and outside risers – dimensions and weights

Cat. Nos.	Width	X	Y	Z	Weight (kg)
SRFIR 75 60 F	75	269	155	55	0.7
SRFIR 100 60 F	100	269	155	55	0.8
SRFIR 150 60 F	150	269	155	55	0.9
SRFIR 225 60 F	225	269	155	55	1.3
SRFIR 300 60 F	300	269	155	55	1.9
SRFIR 450 60 F	450	269	155	55	2.5
SRFIR 600 60 F	600	269	155	55	3.2
SRFIR 750 60 F	750	269	155	55	3.7
SRFIR 900 60 F	900	269	155	55	5.8

Cat. Nos. given in the table are for inside risers. For outside risers substitute SRFOR for SRFIR. All fixed risers radius = 260 mm

■ 45° inside and outside risers – dimensions and weights

Cat. Nos.	Width	X	Y	Z	Weight (kg)
SRFIR 75 45 F	75	220	91	55	0.5
SRFIR 100 45 F	100	220	91	55	0.6
SRFIR 150 45 F	150	220	91	55	0.8
SRFIR 225 45 F	225	220	91	55	1.0
SRFIR 300 45 F	300	220	91	55	1.6
SRFIR 450 45 F	450	220	91	55	2.2
SRFIR 600 45 F	600	220	91	55	2.9
SRFIR 750 45 F	750	220	91	55	3.4
SRFIR 900 45 F	900	220	91	55	5.5

Cat. Nos. given in the table are for inside risers. For outside risers substitute SRFOR for SRFIR. All fixed risers radius = 260 mm

Key : Replace the letter shown in red with your choice from the following options :

- F** = Finish : **G** (hot dip galvanised after manufacture), **D** (deep galvanised), **PG** (pre-galvanised steel), **S** (stainless steel), **E** (powder coated black RAL 9005)

■ 30° inside and outside risers – dimensions and weights

Cat. Nos.	Width	X	Y	Z	Weight (kg)
SRFIR 75 30 F	75	157	42	55	0.4
SRFIR 100 30 F	100	157	42	55	0.4
SRFIR 150 30 F	150	157	42	55	0.6
SRFIR 225 30 F	225	157	42	55	0.7
SRFIR 300 30 F	300	157	42	55	0.7
SRFIR 450 30 F	450	157	42	55	1.6
SRFIR 600 30 F	600	157	42	55	2.2
SRFIR 750 30 F	750	157	42	55	2.9
SRFIR 900 30 F	900	157	42	55	4.2

Cat. Nos. given in the table are for inside risers. For outside risers substitute SRFOR for SRFIR. All fixed risers radius = 260 mm

Dimensions

X = Length of fitting from each end (excluding integral coupler)

Y = Length of fitting from each end (excluding integral coupler)

Z = End extension of integral coupler

Weights

All weights given are in kilograms (kg) and are for hot dip galvanised G finish

To obtain the appropriate component weight in other finishes, multiply the given weight by the following factors :

Deep galvanised (D) x 1.06

Stainless steel (S) x 0.94

Pre-galvanised (PG) x 0.96

Powder coated (E) x 0.97

■ Assembly using Swiftclip – inside and outside risers

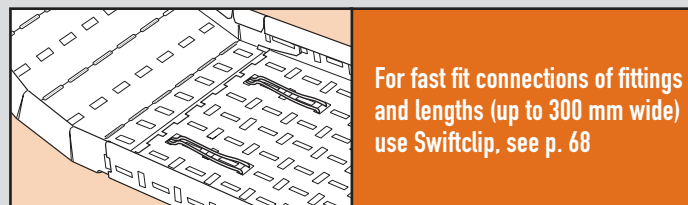

For fast fit connections of fittings and lengths (up to 300 mm wide) use Swiftclip. see p. 68

■ Assembly using fasteners – inside and outside risers

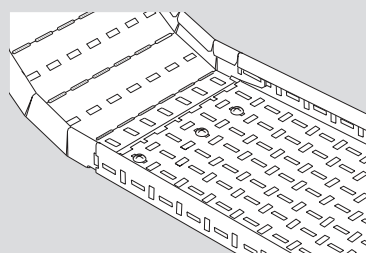

Riser to straight length coupling

Risers have integral couplers which fit into straight lengths whether they have been cut to length or not, without the need for further drilling. Each riser to length joint is secured with M6 x 12 bolts (roofing or pan head), nuts and washers or quick bolt fasteners (Cat. No. QBF), p. 68. Fasteners are not included

Minimum number of fasteners per joint :

Widths up to 225 = 2

Widths 300 to 600 = 3

Widths 750 and 900 = 4

Fastener finishes

For risers with G, D and PG finishes, fasteners are galvanised or zinc plated

For risers with S finish, fasteners are stainless steel

For risers with E finish, the choice of material for fasteners will depend on the installation environment. For further information, contact us on +44 (0) 345 605 4333

All dimensions (mm) are nominal

→ SRF adjustable risers : see p. 75

Swifts® SRF heavy duty fittings

adjustable risers

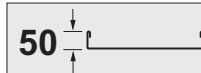

■ Dimensions and weights

The adjustable riser can be used as an inside or outside riser for any angle up to 90°

- Minimum radius = 200 mm
- Maximum radius = 300 mm
- Overall length when flat = 554 mm

Dimensions

Cat. No. SRFAR **W F**

Used as inside riser

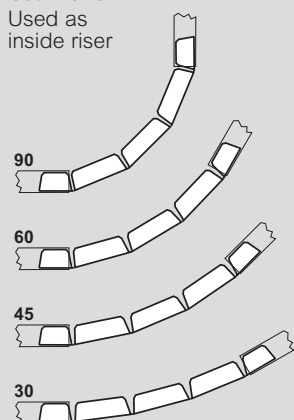

Used as outside riser

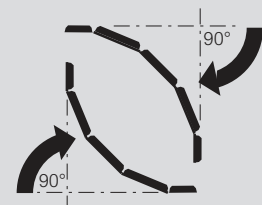
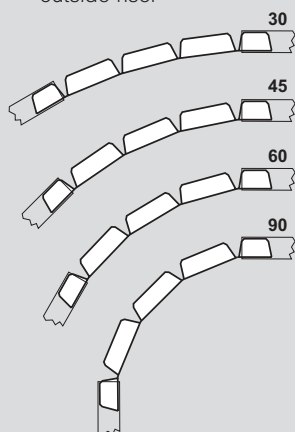

Cat. Nos.	Width (W)	Weight (kg)
SRFAR 75 F	75	0.7
SRFAR 100 F	100	0.8
SRFAR 150 F	150	1.1
SRFAR 225 F	225	1.8
SRFAR 300 F	300	2.4
SRFAR 450 F	450	3.4
SRFAR 600 F	600	4.4
SRFAR 750 F	750	5.5
SRFAR 900 F	900	6.5

Weights

All weights given are in kilograms (kg) and are for hot dip galvanised G finish
To obtain the appropriate component weight in other finishes, multiply the given weight by the following factors :

- Deep galvanised (D) x 1.06
- Stainless steel (S) x 0.94
- Pre-galvanised (PG) x 0.96
- Powder coated (E) x 0.97

Key : Replace the letter shown in red with your choice from the following options :

- F** = Finish : **G** (hot dip galvanised after manufacture), **D** (deep galvanised), **PG** (pre-galvanised steel), **S** (stainless steel), **E** (powder coated black RAL 9005)

■ Assembly

As many riser segments as necessary may be inserted into the end of the straight length, thus avoiding the need for cutting

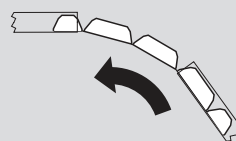

■ Assembly using Swiftclip – adjustable risers

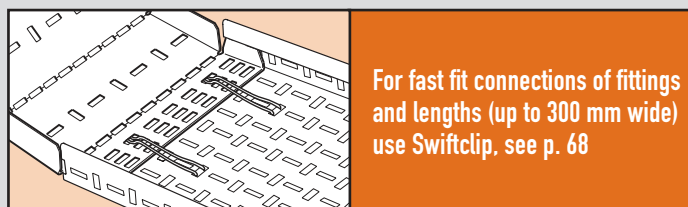

For fast fit connections of fittings and lengths (up to 300 mm wide) use Swiftclip, see p. 68

■ Assembly using fasteners – adjustable risers

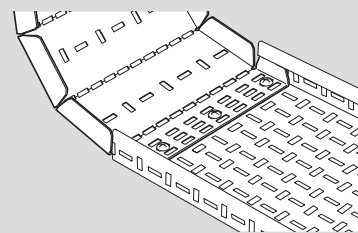

Adjustable riser to straight length coupling

Adjustable risers fit into straight lengths whether they have been cut to length or not, without the need for further drilling
Each riser to length joint is secured with M6 x 12 bolts (roofing or pan head), nuts and washers or quick bolt fasteners (Cat. No. QBF), p. 68. Fasteners are not included

Minimum number of fasteners per joint :

- Widths up to 225 = 2
- Widths 300 to 600 = 3
- Widths 750 and 900 = 4

Fastener finishes

For adjustable riser with G, D and PG finishes, fasteners are galvanised or zinc plated

For adjustable riser with S finish, fasteners are stainless steel

For adjustable riser with E finish, the choice of material for fasteners will depend on the installation environment. For further information, contact us on +44 (0) 345 605 4333

All dimensions (mm) are nominal

➔ SRF inside and outside risers : see p. 74

Swifts® SRF heavy duty fittings

extra long adjustable risers

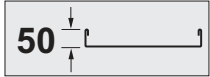

■ Dimensions and weights

The extra long adjustable riser can be used as an inside or outside riser for any angle up to 90°
 Minimum radius = 200 mm
 Maximum radius = 650 mm
 Overall length when flat = 1 087 mm

Dimensions

Cat. No. SRFAXR **W F**

Used as inside riser for any angle up to 90°

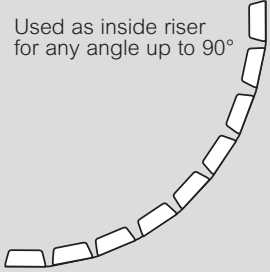

Used as outside riser for any angle up to 90°

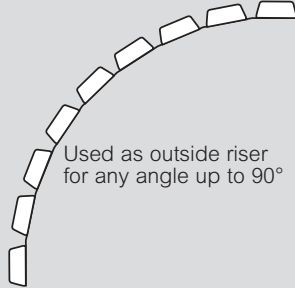

Used to avoid obstacles on site

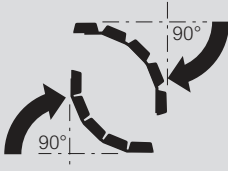
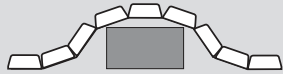

Cat. Nos.	Width (W)	Weight (kg)
SRFAXR 75 F	75	1.4
SRFAXR 100 F	100	1.6
SRFAXR 150 F	150	2.1
SRFAXR 225 F	225	3.7
SRFAXR 300 F	300	4.7
SRFAXR 450 F	450	6.8
SRFAXR 600 F	600	8.8
SRFAXR 750 F	750	10.8
SRFAXR 900 F	900	12.9

Weights

All weights given are in kilograms (kg) and are for hot dip galvanised G finish
 To obtain the appropriate component weight in other finishes, multiply the given weight by the following factors :

Deep galvanised (D)	x 1.06
Stainless steel (S)	x 0.94
Pre-galvanised (PG)	x 0.96
Powder coated (E)	x 0.97

Key : Replace the letter shown in red with your choice from the following options :

- F** = Finish : **G** (hot dip galvanised after manufacture), **D** (deep galvanised), **PG** (pre-galvanised steel), **S** (stainless steel), **E** (powder coated black RAL 9005)

■ Assembly

As many riser segments as necessary may be inserted into the end of the straight length, thus avoiding the need for cutting

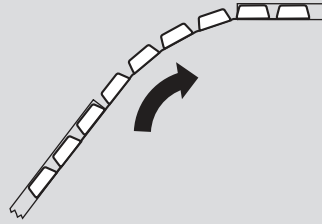

■ Assembly using Swiftclip – extra long adjustable risers

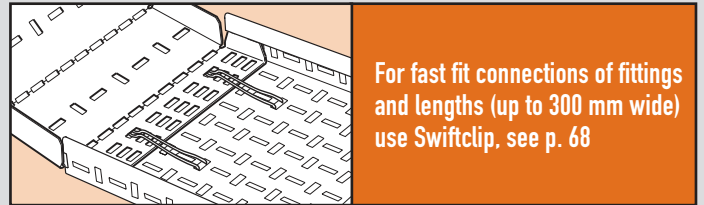

For fast fit connections of fittings and lengths (up to 300 mm wide) use Swiftclip, see p. 68

■ Assembly using fasteners – extra long adjustable risers

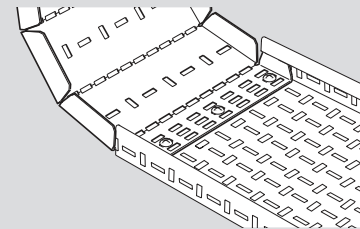

Extra long adjustable riser to straight length coupling

Extra long adjustable risers fit into straight lengths whether they have been cut to length or not, without the need for further drilling
 Each riser to length joint is secured with M6 x 12 bolts (roofing or pan head), nuts and washers or quick bolt fasteners (Cat. No. QBF), p. 68. Fasteners are not included

Minimum number of fasteners per joint :

Widths up to 225	= 2
Widths 300 to 600	= 3
Widths 750 and 900	= 4

Fastener finishes

For adjustable risers with G, D and PG finishes, fasteners are galvanised or zinc plated

For adjustable risers with S finish, fasteners are stainless steel

For adjustable risers with E finish, the choice of material for fasteners will depend on the installation environment. For further information, contact us on +44 (0) 345 605 4333

All dimensions (mm) are nominal

→ SRF inside and outside risers : see p. 74

Swifts® SRF heavy duty fittings

equal tees

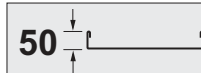

■ Dimensions and weights

Dimensions

Cat. No. SRFT **W F**

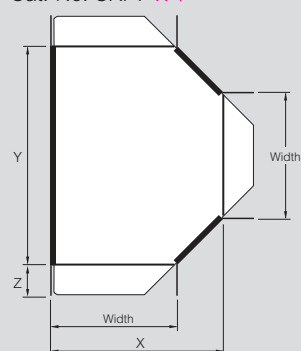

X = Length of fitting from each end (excluding integral coupler)

Y = Length of fitting from each end (excluding integral coupler)

Z = End extension of integral coupler

Cat. Nos.	Width	X	Y	Z	Weight (kg)
SRFT 75 F	75	197	320	55	1.0
SRFT 100 F	100	222	345	55	1.2
SRFT 150 F	150	272	395	55	1.6
SRFT 225 F	225	345	467	55	2.2
SRFT 300 F	300	420	542	55	3.8
SRFT 450 F	450	568	690	55	6.2
SRFT 600 F	600	718	840	55	9.1
SRFT 750 F	750	868	990	55	17.0
SRFT 900 F	900	1018	1140	55	22.6

Weights

All weights given are in kilograms (kg) and are for hot dip galvanised G finish

To obtain the appropriate component weight in other finishes, multiply the given weight by the following factors :

Deep galvanised (D)	x 1.06
Stainless steel (S)	x 0.94
Pre-galvanised (PG)	x 0.96
Powder coated (E)	x 0.97

■ Assembly using Swiftclip – equal tees

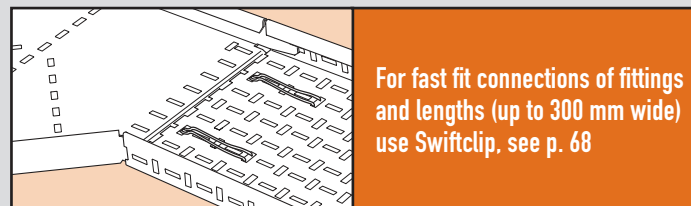

For fast fit connections of fittings and lengths (up to 300 mm wide) use Swiftclip, see p. 68

■ Assembly using fasteners – equal tees

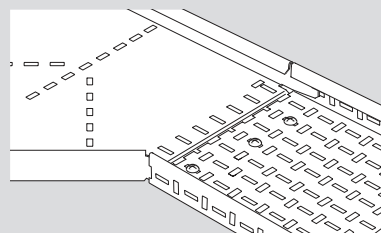

Equal tee to straight length coupling

Equal tees have integral couplers which fit into straight lengths whether they have been cut to length or not, without the need for further drilling. Each equal tee to length joint is secured with M6 x 12 bolts (roofing or pan head), nuts and washers or quick bolt fasteners (Cat. No. QBF), p. 68. Fasteners are not included.

Minimum number of fasteners per joint :

Widths up to 225	= 2
Widths 300 to 600	= 3
Widths 750 and 900	= 4

Fastener finishes

For equal tees with G, D and PG finishes, fasteners are galvanised or zinc plated.

For equal tees with S finish, fasteners are stainless steel.

For equal tees with E finish, the choice of material for fasteners will depend on the installation environment. For further information, contact us on +44 (0) 345 605 4333.

Minimum bend radius for cables

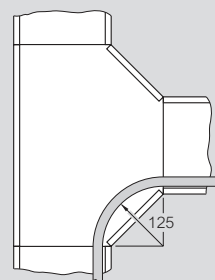

Minimum cable radius = 125 mm

Key : Replace the letter shown in red with your choice from the following options :

- F** = Finish : **G** (hot dip galvanised after manufacture), **D** (deep galvanised), **PG** (pre-galvanised steel), **S** (stainless steel), **E** (powder coated black RAL 9005)

All dimensions (mm) are nominal

➔ SRF unequal tees : see p. 78-79

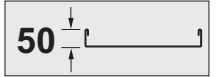

■ Dimensions and weights

Dimensions

Cat. No. SRFUT **W B F**

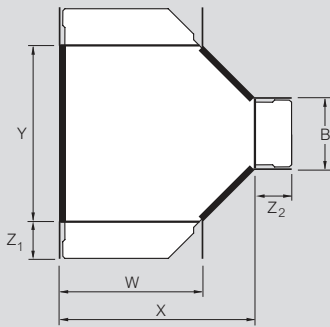

X = Length of fitting from each end (excluding integral coupler)

Y = Length of fitting from each end (excluding integral coupler)

Z₁ = End extension of integral coupler

Z₂ = End extension of integral coupler

Width (W)	Width (B)	Cat. Nos.	Dimensions (mm)				Weight (kg)
			X	Y	Z ₁	Z ₂	
75	100	SRFUT 75 100 F	197	345	55	55	1.1
	150	SRFUT 75 150 F	197	395	55	55	1.2
	225	SRFUT 75 225 F	195	470	55	55	1.4
	300	SRFUT 75 300 F	195	545	55	55	2.0
	450	SRFUT 75 450 F	194	690	55	55	2.6
	600	SRFUT 75 600 F	194	840	55	55	3.2
	750	SRFUT 75 750 F	194	990	55	55	3.8
100	900	SRFUT 75 900 F	194	1 140	55	55	5.7
	75	SRFUT 100 75 F	222	320	55	55	1.1
	150	SRFUT 100 150 F	222	395	55	55	1.3
	225	SRFUT 100 225 F	220	467	55	55	1.6
	300	SRFUT 100 300 F	220	545	55	55	2.2
	450	SRFUT 100 450 F	219	690	55	55	2.8
	600	SRFUT 100 600 F	219	840	55	55	3.4
150	750	SRFUT 100 750 F	219	990	55	55	4.1
	900	SRFUT 100 900 F	219	1 140	55	55	6.2
	75	SRFUT 150 75 F	272	320	55	55	1.3
	100	SRFUT 150 100 F	272	345	55	55	1.4
	225	SRFUT 150 225 F	271	467	55	55	1.8
	300	SRFUT 150 300 F	271	545	55	55	2.6
	450	SRFUT 150 450 F	268	690	55	55	3.3
225	600	SRFUT 150 600 F	268	840	55	55	4.0
	750	SRFUT 150 750 F	268	990	55	55	4.8
	900	SRFUT 150 900 F	268	1 140	55	55	7.2
	75	SRFUT 225 75 F	345	320	55	55	1.6
	100	SRFUT 225 100 F	345	342	55	55	1.7
	150	SRFUT 225 150 F	345	393	55	55	1.9
	300	SRFUT 225 300 F	345	542	55	55	3.2
900	450	SRFUT 225 450 F	343	690	55	55	4.0
	600	SRFUT 225 600 F	343	840	55	55	5.0
	750	SRFUT 225 750 F	343	990	55	55	5.7
	900	SRFUT 225 900 F	343	1 140	55	55	8.7

Width (W)	Width (B)	Cat. Nos.	Dimensions (mm)				Weight (kg)
			X	Y	Z ₁	Z ₂	
300	75	SRFUT 300 75 F	420	320	55	55	2.3
	100	SRFUT 300 100 F	420	342	55	55	2.5
	150	SRFUT 300 150 F	420	393	55	55	2.8
	225	SRFUT 300 225 F	420	467	55	55	3.3
	450	SRFUT 300 450 F	418	690	55	55	4.9
	600	SRFUT 300 600 F	418	840	55	55	5.9
	750	SRFUT 300 750 F	418	990	55	55	9.0
	900	SRFUT 300 900 F	418	1 140	55	55	10.3
	450	75	SRFUT 450 75 F	568	320	55	55
100		SRFUT 450 100 F	568	340	55	55	3.3
150		SRFUT 450 150 F	568	390	55	55	3.7
225		SRFUT 450 225 F	568	465	55	55	4.5
300		SRFUT 450 300 F	568	540	55	55	5.1
600		SRFUT 450 600 F	568	840	55	55	7.7
750		SRFUT 450 750 F	568	990	55	55	11.7
900		SRFUT 450 900 F	568	1 140	55	55	13.3
600		75	SRFUT 600 75 F	718	320	55	55
	100	SRFUT 600 100 F	718	340	55	55	4.1
	150	SRFUT 600 150 F	718	390	55	55	4.6
	225	SRFUT 600 225 F	718	465	55	55	5.5
	300	SRFUT 600 300 F	718	540	55	55	6.3
	450	SRFUT 600 450 F	718	690	55	55	7.9
	750	SRFUT 600 750 F	718	990	55	55	14.3
	900	SRFUT 600 900 F	718	1 140	55	55	16.4
	750	75	SRFUT 750 75 F	868	320	55	55
100		SRFUT 750 100 F	868	340	55	55	6.6
150		SRFUT 750 150 F	868	390	55	55	7.4
225		SRFUT 750 225 F	868	465	55	55	8.6
300		SRFUT 750 300 F	868	540	55	55	9.8
450		SRFUT 750 450 F	868	690	55	55	12.2
600		SRFUT 750 600 F	868	840	55	55	14.6
900		SRFUT 750 900 F	868	1 140	55	55	19.5
900		75	SRFUT 900 75 F	1 018	320	55	55
	100	SRFUT 900 100 F	1 018	340	55	55	7.7
	150	SRFUT 900 150 F	1 018	390	55	55	8.9
	225	SRFUT 900 225 F	1 018	465	55	55	10.0
	300	SRFUT 900 300 F	1 018	540	55	55	11.4
	450	SRFUT 900 450 F	1 018	690	55	55	14.2
	600	SRFUT 900 600 F	1 018	840	55	55	17.0
750	SRFUT 900 750 F	1 018	990	55	55	19.8	

Key : Replace the letter shown in red with your choice from the following options :

- F** = Finish : **G** (hot dip galvanised after manufacture),
- D** (deep galvanised), **PG** (pre-galvanised steel),
- S** (stainless steel), **E** (powder coated black RAL 9005)

Swifts® SRF heavy duty fittings

unequal tees (continued)



■ Dimensions and weights (continued)

Weights

All weights given are in kilograms (kg) and are for hot dip galvanised G finish

To obtain the appropriate component weight in other finishes, multiply the given weight by the following factors :

Deep galvanised (D)	x 1.06
Stainless steel (S)	x 0.94
Pre-galvanised (PG)	x 0.96
Powder coated (E)	x 0.97

■ Assembly using Swiftclip – unequal tees

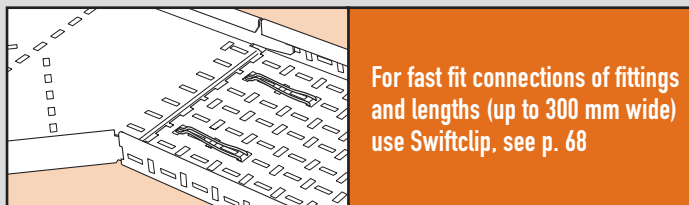

■ Assembly using fasteners – unequal tees

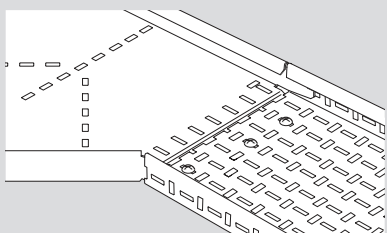

Unequal tee to straight length coupling

Unequal tees have integral couplers which fit into straight lengths whether they have been cut to length or not, without the need for further drilling

Each unequal tee to length joint is secured with M6 x 12 bolts (roofing or pan head), nuts and washers or quick bolt fasteners (Cat. No. QBF), p. 68. Fasteners are not included

Minimum number of fasteners per joint :

Widths up to 225	= 2
Widths 300 to 600	= 3
Widths 750 and 900	= 4

Fastener finishes

For unequal tees with G, D and PG finishes, fasteners are galvanised or zinc plated

For unequal tees with S finish, fasteners are stainless steel

For unequal tees with E finish, the choice of material for fasteners will depend on the installation environment. For further information, contact us on +44 (0) 345 605 4333

Minimum bend radius for cables

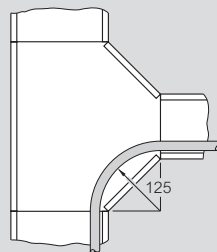

Minimum cable radius = 125 mm

All dimensions (mm) are nominal

→ SRF equal tees : see p. 77

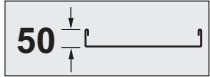

■ Dimensions and weights

Dimensions

Cat. No. SRFX **W F**

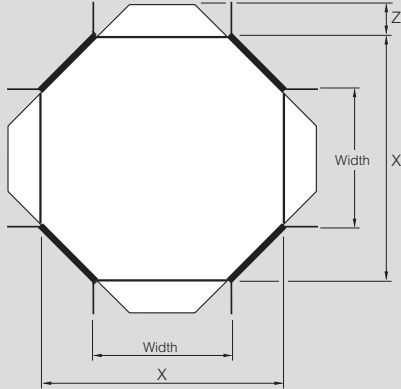

X = Length of fitting from each end (excluding integral coupler)
Z = End extension of integral coupler

Cat. Nos.	Width	X	Z	Weight (kg)
SRFX 75 F	75	320	55	1.3
SRFX 100 F	100	345	55	1.5
SRFX 150 F	150	395	55	1.9
SRFX 225 F	225	467	55	2.7
SRFX 300 F	300	542	55	4.5
SRFX 450 F	450	690	55	7.3
SRFX 600 F	600	840	55	10.6
SRFX 750 F	750	990	55	18.8
SRFX 900 F	900	1 140	55	25.3

Weights

All weights given are in kilograms (kg) and are for hot dip galvanised G finish
To obtain the appropriate component weight in other finishes, multiply the given weight by the following factors :

Deep galvanised (D)	x 1.06
Stainless steel (S)	x 0.94
Pre-galvanised (PG)	x 0.96
Powder coated (E)	x 0.97

■ Assembly using Swiftclip – 4 way crosspieces

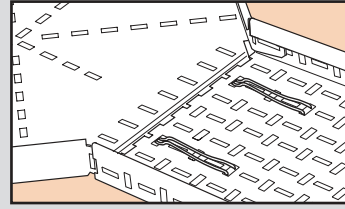

For fast fit connections of fittings and lengths (up to 300 mm wide) use Swiftclip, see p. 68

■ Assembly using fasteners – 4 way crosspieces

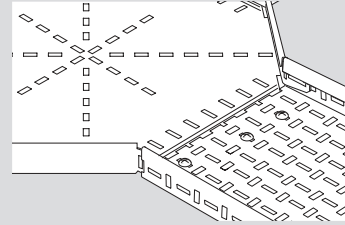

4 way crosspiece to straight length coupling

Crosspieces have integral couplers which fit into straight lengths whether they have been cut to length or not, without the need for further drilling

Each crosspiece to length joint is secured with M6 x 12 bolts (roofing or pan head), nuts and washers or quick bolt fasteners (Cat. No. QBF), p. 68. Fasteners are not included

Minimum number of fasteners per joint :

Widths up to 225	= 2
Widths 300 to 600	= 3
Widths 750 and 900	= 4

Fastener finishes

For crosspieces with G, D and PG finishes, fasteners are galvanised or zinc plated

For crosspieces with S finish, fasteners are stainless steel

For crosspieces with E finish, the choice of material for fasteners will depend on the installation environment. For further information, contact us on +44 (0) 345 605 4333

Minimum bend radius for cables

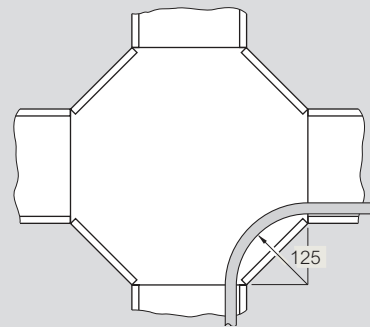

Minimum cable radius = 125 mm

Key : Replace the letter shown in red with your choice from the following options :

- F** = Finish : **G** (hot dip galvanised after manufacture), **D** (deep galvanised), **PG** (pre-galvanised steel), **S** (stainless steel), **E** (powder coated black RAL 9005)

All dimensions (mm) are nominal

Swifts® SRF heavy duty fittings

straight reducers

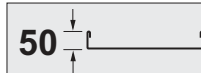

■ Dimensions and weights

Dimensions

Cat. No. SRFR **W K F**

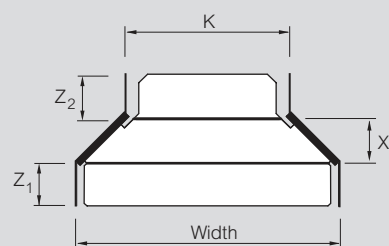

X = Length of fitting from each end (excluding integral coupler)

Z₁ = End extension of integral coupler

Z₂ = End extension of integral coupler

K = Reduced width

Width	Width (K)	Cat. Nos.	Dimensions (mm)			Weight (kg)
			X	Z ₁	Z ₂	
100	75	SRFR 100 75 F	100	55	55	0.3
	75	SRFR 150 75 F	100	55	55	0.4
150	100	SRFR 150 100 F	100	55	55	0.4
	75	SRFR 225 75 F	100	55	55	0.5
225	100	SRFR 225 100 F	100	55	55	0.5
	150	SRFR 225 150 F	100	55	55	0.6
300	75	SRFR 300 75 F	150	55	55	0.6
	100	SRFR 300 100 F	100	55	55	0.6
	150	SRFR 300 150 F	100	55	55	0.6
	225	SRFR 300 225 F	100	55	55	0.6
450	75	SRFR 450 75 F	300	55	55	1.5
	100	SRFR 450 100 F	300	55	55	1.5
	150	SRFR 450 150 F	150	55	55	1.0
	225	SRFR 450 225 F	150	55	55	1.0
	300	SRFR 450 300 F	100	55	55	1.1
600	75	SRFR 600 75 F	300	55	55	1.8
	100	SRFR 600 100 F	300	55	55	1.8
	150	SRFR 600 150 F	300	55	55	1.9
	225	SRFR 600 225 F	300	55	55	2.0
	300	SRFR 600 300 F	150	55	55	2.7
750	450	SRFR 600 450 F	100	55	55	2.7
	75	SRFR 750 75 F	450	55	55	2.6
	100	SRFR 750 100 F	450	55	55	2.6
	150	SRFR 750 150 F	300	55	55	2.6
	225	SRFR 750 225 F	300	55	55	2.9
	300	SRFR 750 300 F	300	55	55	3.1
900	450	SRFR 750 450 F	300	55	55	3.4
	600	SRFR 750 600 F	100	55	55	3.8
	75	SRFR 900 75 F	450	55	55	4.2
	100	SRFR 900 100 F	450	55	55	4.4
	150	SRFR 900 150 F	450	55	55	4.4
	225	SRFR 900 225 F	450	55	55	4.6
	300	SRFR 900 300 F	300	55	55	5.5
900	450	SRFR 900 450 F	300	55	55	5.8
	600	SRFR 900 600 F	300	55	55	6.1
	750	SRFR 900 750 F	100	55	55	6.3

Key : Replace the letter shown in red with your choice from the following options :

- F** = Finish : **G** (hot dip galvanised after manufacture), **D** (deep galvanised), **PG** (pre-galvanised steel), **S** (stainless steel), **E** (powder coated black RAL 9005)

■ Dimensions and weights (continued)

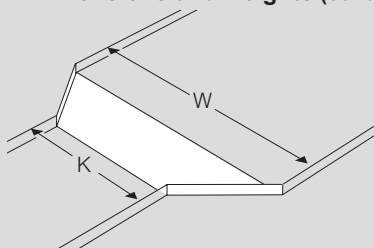

To create the Cat. No. add the main run width (W), the reduced run width (K) and the finish (F)

Example :

For a hot dip galvanised reducer reducing from 300 mm to 150 mm : SRFR 300 150 G

Weights

All weights given are in kilograms (kg) and are for hot dip galvanised G finish

To obtain the appropriate component weight in other finishes, multiply the given weight by the following factors :

- Deep galvanised (D) x 1.06
- Stainless steel (S) x 0.94
- Pre-galvanised (PG) x 0.96
- Powder coated (E) x 0.97

■ Assembly using Swiftclip – straight reducers

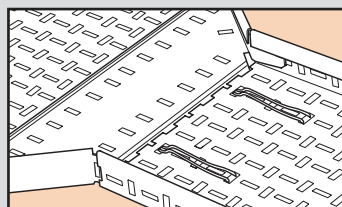

For fast fit connections of fittings and lengths (up to 300 mm wide) use Swiftclip, see p. 68

■ Assembly using fasteners – straight reducers

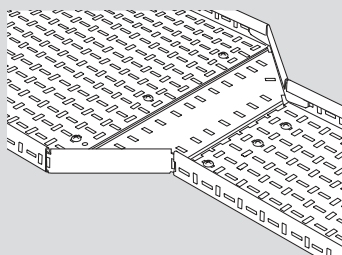

Reducer to straight length coupling

Reducers have integral couplers which fit into straight lengths whether they have been cut to length or not, without the need for further drilling. Each reducer to length joint is secured with M6 x 12 bolts (roofing or pan head), nuts and washers or quick bolt fasteners (Cat. No. QBF), p. 68. Fasteners are not included

Minimum number of fasteners per joint :

- Widths up to 225 = 2
- Widths 300 to 600 = 3
- Widths 750 and 900 = 4

Fastener finishes

For reducers with G, D and PG finishes, fasteners are galvanised or zinc plated

For reducers with S finish, fasteners are stainless steel

For reducers with E finish, the choice of material for fasteners will depend on the installation environment. For further information, contact us on +44 (0) 345 605 4333

All dimensions (mm) are nominal

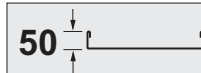

■ Dimensions and weights

Cat. No. SRFMRFR **W F**

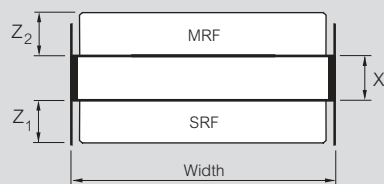

Cat. Nos.	Width	X	Y	Z	Weight (kg)
SRFMRFR 75 F	75	150	55	55	0.2
SRFMRFR 100 F	100	150	55	55	0.3
SRFMRFR 150 F	150	150	55	55	0.4
SRFMRFR 225 F	225	150	55	55	0.5
SRFMRFR 300 F	300	150	55	55	0.6
SRFMRFR 450 F	450	150	55	55	1.1
SRFMRFR 600 F	600	150	55	55	1.4
SRFMRFR 750 F	750	150	55	55	1.4
SRFMRFR 900 F	900	150	55	55	2.2

Dimensions

X = Length of fitting from each end (excluding integral coupler)

Z₁ = End extension of integral coupler

Z₂ = End extension of integral coupler

Weights

All weights given are in kilograms (kg) and are for hot dip galvanised G finish

To obtain the appropriate component weight in other finishes, multiply the given weight by the following factors :

Deep galvanised (D)	x 1.06
Stainless steel (S)	x 0.94
Pre-galvanised (PG)	x 0.96
Powder coated (E)	x 0.97

■ Assembly using Swiftclip – SRF to MRF straight reducers

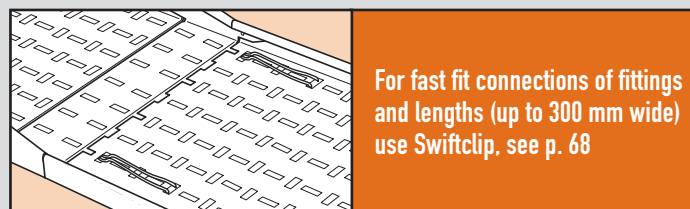

For fast fit connections of fittings and lengths (up to 300 mm wide) use Swiftclip, see p. 68

■ Assembly using fasteners – SRF to MRF straight reducers

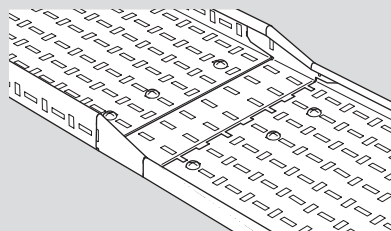

Straight reducer to straight length coupling

Reducers have integral couplers which fit into straight lengths whether they have been cut to length or not, without the need for further drilling. Each reducer to length joint is secured with M6 x 12 bolts (roofing or pan head), nuts and washers or quick bolt fasteners (Cat. No. QBF), p. 68. Fasteners are not included.

Minimum number of fasteners per joint :

Widths up to 225	= 2
Widths 300 to 600	= 3
Widths 750 and 900	= 4

Fastener finishes

For reducers with G, D and PG finishes, fasteners are galvanised or zinc plated

For reducers with S finish, fasteners are stainless steel

For reducers with E finish, the choice of material for fasteners will depend on the installation environment. For further information, contact us on +44 (0) 345 605 4333

Key : Replace the letter shown in red with your choice from the following options :

F = Finish : **G** (hot dip galvanised after manufacture),
D (deep galvanised), **PG** (pre-galvanised steel),
S (stainless steel), **E** (powder coated black RAL 9005)

All dimensions (mm) are nominal

→ MRF straight lengths : see p. 46

→ SRF straight lengths : see p. 64

Swifts® SRF heavy duty fittings

handed reducers

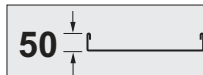

■ On-site fabrication of fittings

For on-site fabrication of fittings, including left or right handed reducers, use universal brackets and fishplates, see p. 85
 Left and right handed reducers are not currently available as a standard factory fabricated fitting

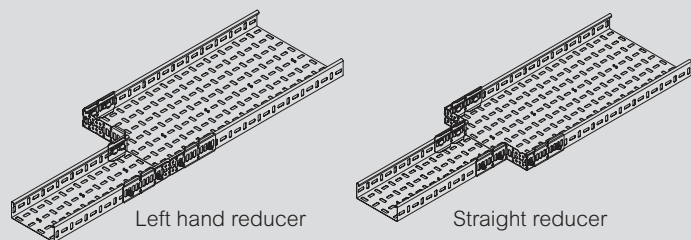

■ Dimensions and weights

Figures show approximated reduced widths

		SRFL															
Smaller Size	75 mm		100 mm		150 mm		225 mm		300 mm		450 mm		600 mm		750 mm		
Larger Size	Handed	Straight	Handed	Straight	Handed	Straight	Handed	Straight	Handed	Straight	Handed	Straight	Handed	Straight	Handed	Straight	
100 mm	25	12	–	–	–	–	–	–	–	–	–	–	–	–	–	–	
150 mm	75	37	50	25	–	–	–	–	–	–	–	–	–	–	–	–	
225 mm	150	75	125	62	75	37	–	–	–	–	–	–	–	–	–	–	
300 mm	–	112	200	100	150	75	75	37	–	–	–	–	–	–	–	–	
450 mm	–	–	–	175	–	150	–	112	150	75	–	–	–	–	–	–	
600 mm	–	–	–	–	–	–	–	187	–	150	150	75	–	–	–	–	
750 mm	–	–	–	–	–	–	–	–	–	–	–	150	150	75	–	–	
900 mm	–	–	–	–	–	–	–	–	–	–	–	–	–	150	150	75	

→ Universal bracket : see p. 69

→ Universal fishplate : see p. 69

All dimensions (mm) are nominal

Swifts® XRF extra heavy duty return flange

straight lengths

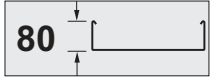

■ Dimensions and weights

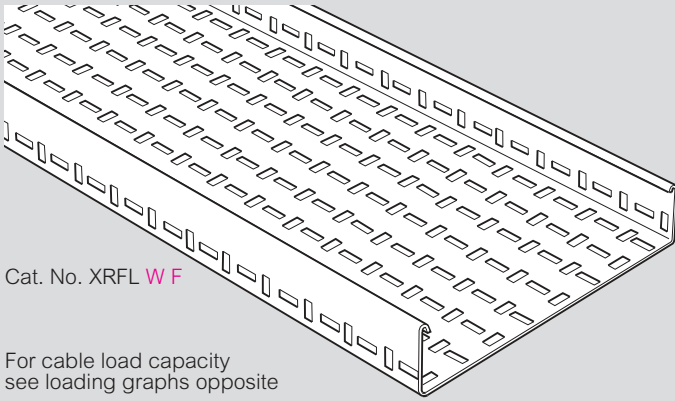

Cat. No. XRFL **W F**

For cable load capacity see loading graphs opposite

■ Dimensions

Standard length 3 m

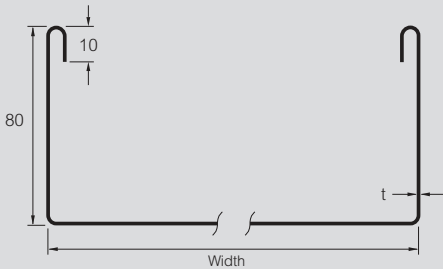
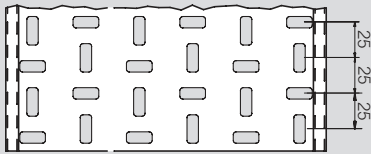

■ Gauges and weights

The gauge 't' for each cable tray width and finish varies by product and range

Non-standard gauges and finishes are available to special order, contact us on +44 (0) 345 605 4333

Cat. Nos.	Width (mm)	Weight (kg)	Gauge t (mm) G finish only
XRFL 100 F	100	9.0	1.2
XRFL 150 F	150	10.2	1.2
XRFL 225 F	225	13.0	1.2
XRFL 300 F	300	15.3	1.5
XRFL 450 F	450	26.4	1.5
XRFL 600 F	600	32.5	2.0

All weights given are in kilograms (kg) and are for a 3 m straight length in hot dip galvanised G finish

To obtain the appropriate component weight in other finishes, multiply the given weight by the following factors :

Deep galvanised (D) x 1.06
Stainless steel (S) x 0.94

Key : Replace the letter shown in red with your choice from the following options :

F = Finish : **G** (hot dip galvanised after manufacture),
D (deep galvanised), **S** (stainless steel)

■ Loading graphs

Load tests carried out to BS EN 61537 and shown in kg/m

Cable fill figure is the maximum physical load of cables that can be fitted into tray and is based on 1700kg/m³ as detailed in the BEAMA "Best Practice guide to cable ladder and cable tray systems"

The loads shown on all graphs are the safe recommended maximum loads that can be applied and must include wind, snow and any other external forces in addition to the cable load

The graph shows the maximum load for tray installed at a support spacing within its recommended range

100-600 mm width trays

XRF G SWL 100-600

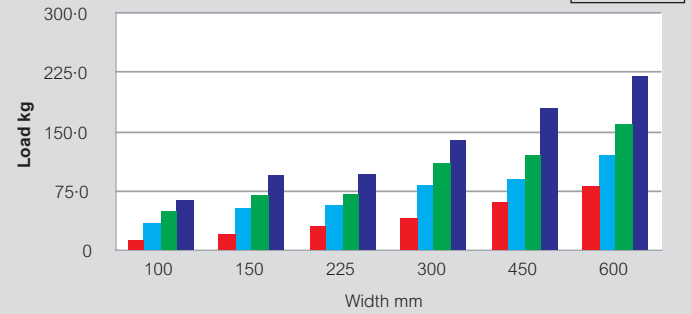

On XRF lengths the graph shows the maximum safe working load when a fishplate is fitted across the underside of each length-to-length joint. Typical cable loads which are normally 50% of the maximum would not require a fishplate

■ Finishes and standards

Standard stocked finish :

G Hot dip galvanised after manufacture to BS EN ISO 1461

Additional finishes :

D Deep galvanised high silicon steel made from BS EN 10025-5 : 2004 Grade S355J0WP

S Stainless steel to BS EN 10088 - 2 grade 1.4404 (equivalent to 316L31)



Sheared steel (particularly stainless steel) does have relatively sharp edges and protective gloves must be worn during handling

All dimensions (mm) are nominal

→ Coupler sets : see p. 85

→ Fishplates : see p. 105

Swifts® cable tray couplers and fasteners

XRF straight length to straight length couplers and straight length to fitting coupling

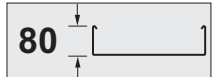

Standard couplers

Couplers are required for joining together XRF straight lengths or cut lengths of tray
XRFC standard couplers are supplied in pairs
Supplied without fasteners – use M6 nuts, bolts and washers (see opposite)

Assembly

Bring together two lengths and fit a coupler on the outside of adjacent flanges at both sides of the tray joint
Locate the coupler as shown and insert two roofing bolts through aligning slots in each tray bed and coupler (four bolts per coupler), and secure with roofing washers and nuts

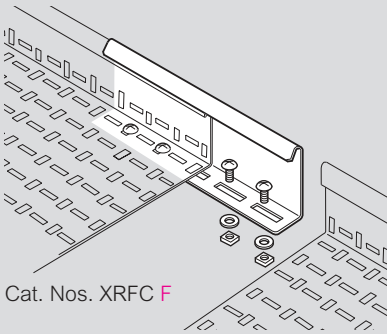

Cat. Nos. XRFC F

Fasteners

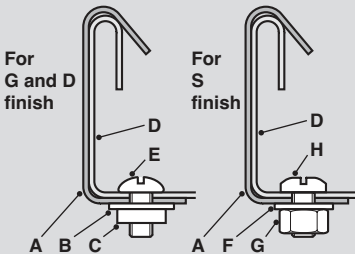

- A Coupler
- B Roofing washer
- C M6 square nut
- D Straight length
- E M6 x 12 roofing bolt
- F M6 form A washer
- G M6 hexagon nut
- H M6 x 12 pan head screw

Fastener finishes

For lengths and fittings with G and D finishes fasteners are galvanised or zinc plated. For trays and fittings with S finish, fasteners are corrosion resistant stainless Grade A470

Dimensions and weights

Cat. No. XRFC F

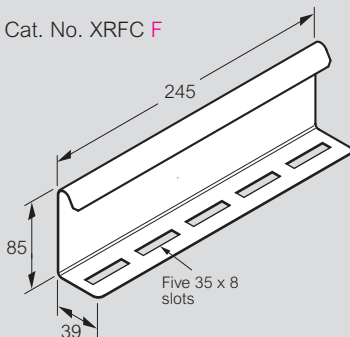

Cat. Nos.	Weight (kg)
XRFC F	0.9 pair

Weights

All weights given are in kilograms (kg) and are for hot dip galvanised G finish
To obtain the appropriate component weight in other finishes, multiply the given weight by the following factors :
Deep galvanised (D) x 1.06
Stainless steel (S) x 0.94

Key : Replace the letter shown in red with your choice from the following options :

F = Finish : **G** (hot dip galvanised after manufacture), **D** (deep galvanised), **S** (stainless steel)

Straight length to fitting coupling

Cable tray fittings must be properly supported. The ideal location for supports is shown in step 2, i.e. 150 mm from the fitting to length joint. For further details see Design Notes, Recommended Support Locations, p. 132

1 Where necessary re-align the fitting flange tabs from their transit position to their installation position

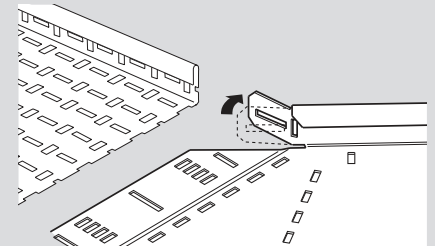

2 When a straight length of cable tray has to be cut back to accept a fitting, always fit the uncut end to the adjacent straight length; the cut end should be connected to the fitting

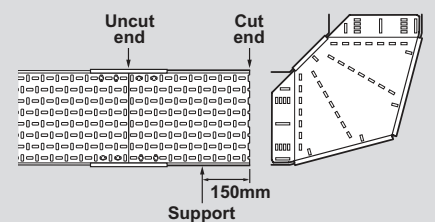

3 Offer the fitting at an angle to the straight length and locate, ensuring that the joggled fishplate fits under the tray bed and the flange tabs slide inside the length flanges

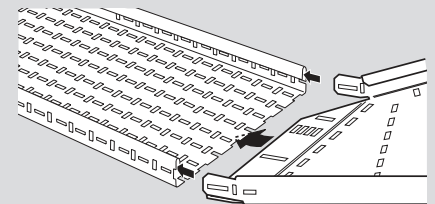

4 Insert roofing bolts through slots in the tray bed in to aligning slots in the fitting fishplate and secure with roofing washers and nuts

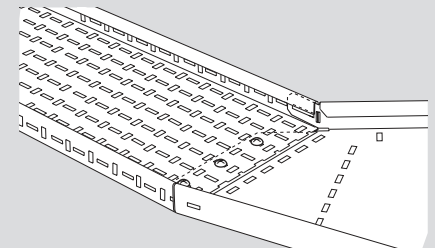

Note

Fasteners stated are for D and G finishes
For lengths and fittings with S finish use fasteners listed below

Fasteners

Minimum number of fasteners per joint (not included) :
Widths up to 225 = 2
Widths 300 to 600 = 3
Widths 750 and 900 = 4

For G and D finish

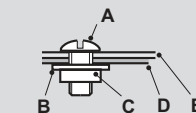

For S finish

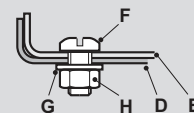

- A M6 x 12 roofing bolt
- B Roofing washer
- C M6 square nut
- D Fitting
- E Straight length
- F M6 x 12 pan head screw
- G M6 form A washer
- H M6 hexagon nut

Fastener finish

For lengths and fittings with G and D finishes, fasteners are galvanised or zinc plated. For trays and fittings with S finish, fasteners are corrosion resistant stainless Grade A470

All dimensions (mm) are nominal

➔ Straight lengths : see p. 84

Swifts® XRF extra heavy duty fittings

flat bends – 90°, 60°, 45° and 30°

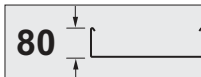

■ 90° dimensions and weights

Cat. No. XRFB **W F**

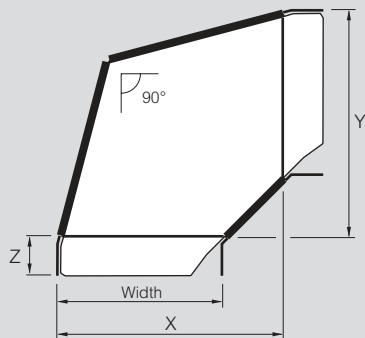

Cat. Nos.	Width	X	Y	Z	Weight (kg)
XRFB 100 F	100	280	280	55	1.6
XRFB 150 F	150	330	330	55	2.0
XRFB 225 F	225	405	405	55	2.8
XRFB 300 F	300	480	480	55	3.6
XRFB 450 F	450	690	690	55	8.7
XRFB 600 F	600	840	840	55	12.2

■ 60° dimensions and weights

Cat. No. XRFB **W 60 F**

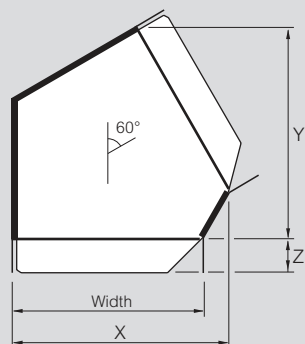

Cat. Nos.	Width	X	Y	Z	Weight (kg)
XRFB 100 60 F	100	190	242	55	1.2
XRFB 150 60 F	150	240	286	55	1.6
XRFB 225 60 F	225	315	351	55	2.1
XRFB 300 60 F	300	390	416	55	2.8
XRFB 450 60 F	450	570	598	55	6.5
XRFB 600 60 F	600	720	727	55	9.2

■ 45° dimensions and weights

Cat. No. XRFB **W 45 F**

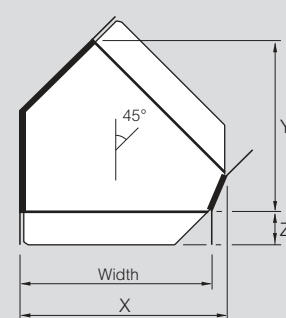

Cat. Nos.	Width	X	Y	Z	Weight (kg)
XRFB 100 45 F	100	153	198	55	1.0
XRFB 150 45 F	150	203	233	55	1.2
XRFB 225 45 F	225	278	286	55	1.6
XRFB 300 45 F	300	353	339	55	2.1
XRFB 450 45 F	450	520	488	55	5.0
XRFB 600 45 F	600	670	594	55	6.9

■ 30° dimensions and weights

Cat. No. XRFB **W 30 F**

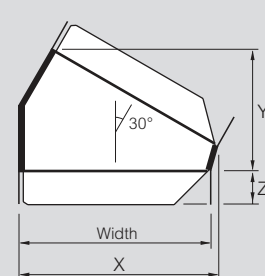

Cat. Nos.	Width	X	Y	Z	Weight (kg)
XRFB 100 30 F	100	124	140	55	0.8
XRFB 150 30 F	150	174	165	55	0.9
XRFB 225 30 F	225	249	202	55	1.2
XRFB 300 30 F	300	324	240	55	1.6
XRFB 450 30 F	450	482	345	55	3.5
XRFB 600 30 F	600	632	420	55	5.0

Key : Replace the letter shown in red with your choice from the following options :

F = Finish : **G** (hot dip galvanised after manufacture),
D (deep galvanised), **S** (stainless steel)

All dimensions (mm) are nominal

Swifts® XRF extra heavy duty fittings

flat bends – 90°, 60°, 45° and 30° (continued)

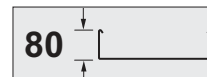

■ Dimensions and weights – flat bends 90°, 60°, 45° and 30°

Dimensions

X = Length of fitting from each end (excluding integral coupler)

Y = Length of fitting from each end (excluding integral coupler)

Z = End extension of integral coupler

Weights

All weights given are in kilograms (kg) and are for hot dip galvanised G finish

To obtain the appropriate component weight in other finishes, multiply the given weight by the following factors :

Deep galvanised (D) x 1.06

Stainless steel (S) x 0.94

■ Assembly – flat bends 90°, 60°, 45° and 30°

Coupling detail

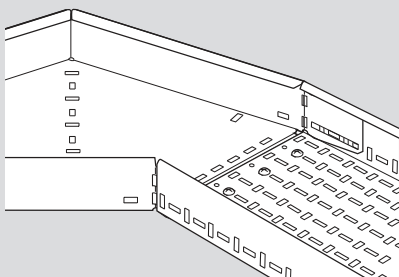

Flat bend to straight length coupling

Flat bends have integral couplers which fit into straight lengths whether they have been cut to length or not, without the need for further drilling

Each flat bend to length joint is secured with M6 x 12 bolts (roofing or pan head), nuts and washers, **p. 85**. Fasteners are not included

Minimum number of fasteners per joint :

Widths up to 225 = 2

Widths 300 to 600 = 3

Fastener finishes

For bends with G and D finishes, fasteners are galvanised or zinc plated

For bends with S finish, fasteners are stainless steel

■ Assembly – flat bends 90°, 60°, 45° and 30° (continued)

Minimum bend radius for cables – flat bends 90°

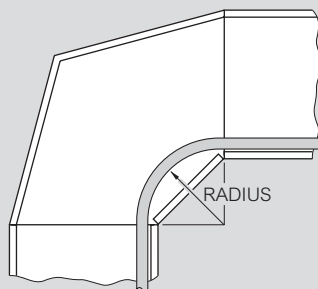

Width (mm)	Radius (mm)
100 to 300	180
450 and 600	240

Minimum bend radius for cables – flat bends 60°, 45° and 30°

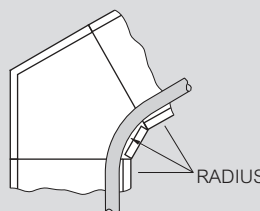

Width (mm)	Radius (mm)
100 to 300	180
450 and 600	240

Key : Replace the letter shown in red with your choice from the following options :

F = Finish : **G** (hot dip galvanised after manufacture),
D (deep galvanised), **S** (stainless steel)

All dimensions (mm) are nominal

Swifts® XRF extra heavy duty fittings

inside and outside risers – 90°, 60°, 45° and 30°

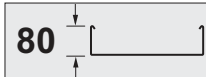

90° dimensions and weights

Dimensions

Cat. No. XRFIR **W F**

Cat. No. XRFOR **W F**

90° inside riser

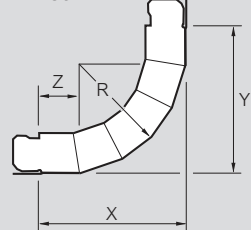

90° outside riser

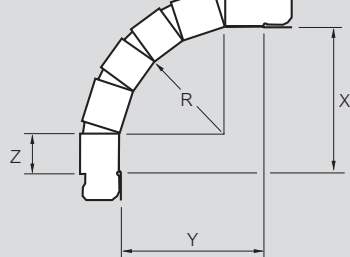

Cat. Nos.	Width	X	Y	Z	Weight (kg)
XRFIR 100 F	100	241	241	55	2.2
XRFOR 100 F	100	240	240	55	2.6
XRFIR 150 F	150	241	241	55	2.5
XRFOR 150 F	150	240	240	55	2.9
XRFIR 225 F	225	241	241	55	2.9
XRFOR 225 F	225	240	240	55	3.3
XRFIR 300 F	300	241	241	55	3.3
XRFOR 300 F	300	240	240	55	3.8
XRFIR 450 F	450	295	295	55	6.2
XRFOR 450 F	450	293	293	55	6.6
XRFIR 600 F	600	295	295	55	7.6
XRFOR 600 F	600	293	293	55	8.1

60° dimensions and weights

Dimensions

Cat. No. XRFIR **W 60 F**

Cat. No. XRFOR **W 60 F**

60° inside riser

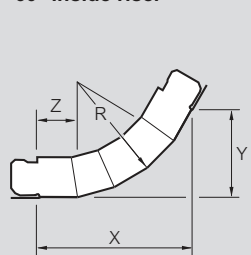

60° outside riser

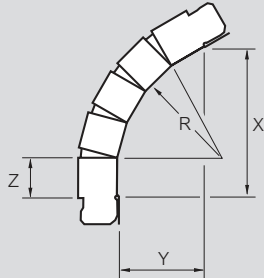

Cat. Nos.	Width	X	Y	Z	Weight (kg)
XRFIR 100 60 F	100	172	99	55	2.0
XRFOR 100 60 F	100	230	133	55	1.4
XRFIR 150 60 F	150	172	99	55	2.1
XRFOR 150 60 F	150	230	133	55	2.5
XRFIR 225 60 F	225	172	99	55	2.4
XRFOR 225 60 F	225	230	133	55	2.8
XRFIR 300 60 F	300	172	99	55	2.8
XRFOR 300 60 F	300	230	133	55	3.1
XRFIR 450 60 F	450	212	122	55	4.9
XRFOR 450 60 F	450	270	161	55	5.3
XRFIR 600 60 F	600	212	122	55	6.0
XRFOR 600 60 F	600	270	161	55	6.4

Key : Replace the letter shown in red with your choice from the following options :

F = Finish : **G** (hot dip galvanised after manufacture),
D (deep galvanised), **S** (stainless steel)

45° dimensions and weights

Dimensions

Cat. No. XRFIR **W 45 F**

Cat. No. XRFOR **W 45 F**

45° inside riser

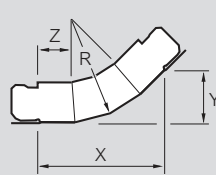

45° outside riser

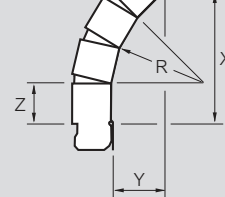

Cat. Nos.	Width	X	Y	Z	Weight (kg)
XRFIR 100 45 F	100	234	97	55	1.2
XRFOR 100 45 F	100	233	96	55	1.3
XRFIR 150 45 F	150	234	97	55	1.7
XRFOR 150 45 F	150	233	96	55	1.7
XRFIR 225 45 F	225	234	97	55	2.0
XRFOR 225 45 F	225	233	96	55	2.2
XRFIR 300 45 F	300	234	97	55	2.3
XRFOR 300 45 F	300	233	96	55	2.4
XRFIR 450 45 F	450	266	110	55	4.1
XRFOR 450 45 F	450	265	110	55	4.3
XRFIR 600 45 F	600	266	110	55	5.1
XRFOR 600 45 F	600	265	110	55	5.3

30° dimensions and weights

Dimensions

Cat. No. XRFIR **W 30 F**

Cat. No. XRFOR **W 30 F**

30° inside riser

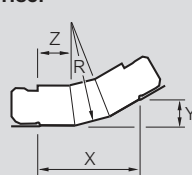

30° outside riser

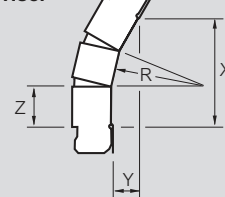

Cat. Nos.	Width	X	Y	Z	Weight (kg)
XRFIR 100 30 F	100	201	54	55	1.1
XRFOR 100 30 F	100	200	54	55	1.1
XRFIR 150 30 F	150	201	54	55	1.3
XRFOR 150 30 F	150	200	54	55	1.5
XRFIR 225 30 F	225	201	54	55	1.9
XRFOR 225 30 F	225	200	54	55	1.7
XRFIR 300 30 F	300	201	54	55	1.9
XRFOR 300 30 F	300	200	54	55	2.0
XRFIR 450 30 F	450	217	58	55	3.4
XRFOR 450 30 F	450	217	58	55	3.5
XRFIR 600 30 F	600	217	58	55	4.1
XRFOR 600 30 F	600	217	58	55	4.2

All dimensions (mm) are nominal

Swifts® XRF extra heavy duty fittings

inside and outside risers – 90°, 60°, 45° and 30° (continued)

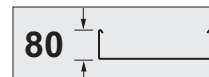

■ Dimensions and weights – inside and outside risers 90°, 60°, 45° and 30°

Dimensions

X = Length of fitting from each end (excluding integral coupler)
 Y = Length of fitting from each end (excluding integral coupler)
 Z = End extension of integral coupler

Weights

All weights given are in kilograms (kg) and are for hot dip galvanised G finish
 To obtain the appropriate component weight in other finishes, multiply the given weight by the following factors :
 Stainless steel (S) x 0.94
 Deep galvanised (D) x 1.06

■ Assembly – inside and outside risers 90°, 60°, 45° and 30°

Coupling detail

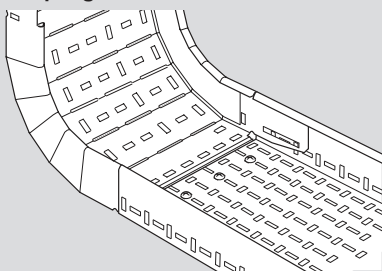

Riser to straight length coupling

Risers have integral couplers which fit into straight lengths whether they have been cut to length or not, without the need for further drilling
 Each riser to length joint is secured with M6 x 12 bolts (roofing or pan head), nuts and washers, **p. 85**. Fasteners are not included
 Minimum number of fasteners per joint :

Widths up to 225 = 2
 Widths 300 to 600 = 3

Fastener finishes

For risers with G and D finishes, fasteners are galvanised or zinc plated. For risers with S finish, fasteners are stainless steel

Minimum bend radius for cables – 90°, 60°, 45° and 30°

Width (W) (mm)	Radius (R) (mm)
100	180
150	180
225	180
300	180
450	240
600	240

Key : Replace the letter shown in red with your choice from the following options :

F = Finish : **G** (hot dip galvanised after manufacture),
D (deep galvanised), **S** (stainless steel)

All dimensions (mm) are nominal

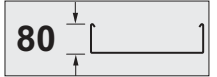

■ Dimensions and weights

Dimensions

Cat. No. XRFT **W F**

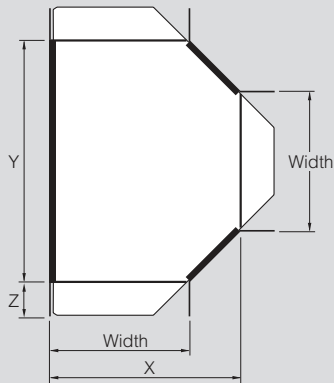

X = Length of fitting from each end (excluding integral coupler)

Y = Length of fitting from each end (excluding integral coupler)

Z = End extension of integral coupler

Cat. Nos.	Width	X	Y	Z	Weight (kg)
XRFT 100 F	100	280	460	55	2.7
XRFT 150 F	150	330	510	55	3.4
XRFT 225 F	225	405	585	55	4.4
XRFT 300 F	300	480	660	55	5.7
XRFT 450 F	450	690	930	55	13.3
XRFT 600 F	600	840	1080	55	18.2

Weights

All weights given are in kilograms (kg) and are for hot dip galvanised G finish

To obtain the appropriate component weight in other finishes, multiply the given weight by the following factors :

- Deep galvanised (D) x 1.06
- Stainless steel (S) x 0.94

■ Assembly

Coupling detail

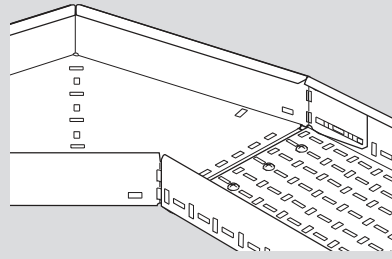

Equal tee to straight length coupling

Equal tees have integral couplers which fit into straight lengths whether they have been cut to length or not, without the need for further drilling. Each equal tee to length joint is secured with M6 x 12 bolts (roofing or pan head), nuts and washers, **p. 85**. Fasteners are not included. Minimum number of fasteners per joint :

- Widths up to 225 = 2
- Widths 300 to 600 = 3

Fastener finishes

For equal tees with G and D finishes, fasteners are galvanised or zinc plated. For equal tees with S finish, fasteners are stainless steel

Minimum bend radius for cables

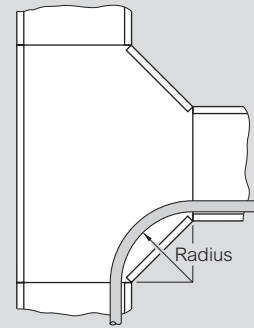

Width (mm)	Radius (mm)
100 to 300	180
450 and 600	240

Key : Replace the letter shown in red with your choice from the following options :

F = Finish : **G** (hot dip galvanised after manufacture),
D (deep galvanised), **S** (stainless steel)

All dimensions (mm) are nominal

➔ XRF unequal tees : see p. 91

Swifts® XRF extra heavy duty fittings

unequal tees

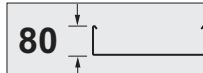

■ Dimensions and weights

Dimensions

Cat. No. XRFUT **W B F**

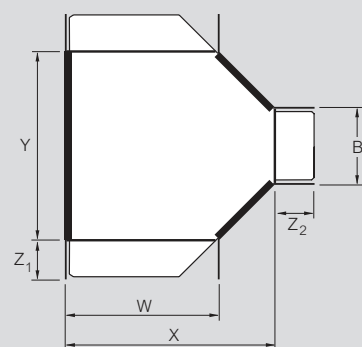

X = Length of fitting from each end (excluding integral coupler)

Y = Length of fitting from each end (excluding integral coupler)

Z = End extension of integral coupler

■ Assembly

Coupling detail

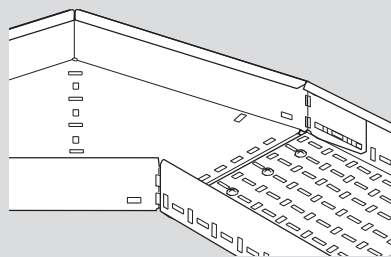

Unequal tee to straight length coupling

Unequal tees have integral couplers which fit into straight lengths whether they have been cut to length or not, without the need for further drilling

Each unequal tee to length joint is secured with M6 x 12 bolts (roofing or pan head), nuts and washers, **p. 85**. Fasteners are not included

Minimum number of fasteners per joint :

Widths up to 225 = 2

Widths 300 to 600 = 3

Fastener finishes

For unequal tees with G and D finishes, fasteners are galvanised or zinc plated. For unequal tees with S finish, fasteners are stainless steel

Minimum bend radius for cables

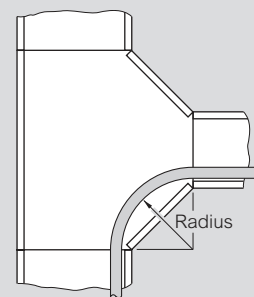

Width (mm)	Radius (mm)
100 to 300	180
450 and 600	240

Width (W)	Width (B)	Cat. Nos.	Dimensions (mm)			Weight (kg)
			X	Y	Z	
100	150	XRFUT 100 150 F	280	510	55	2.9
	225	XRFUT 100 225 F	280	585	55	3.2
	300	XRFUT 100 300 F	280	660	55	3.6
	450	XRFUT 100 450 F	280	810	55	4.4
	600	XRFUT 100 600 F	280	960	55	5.2
150	100	XRFUT 150 100 F	330	460	55	2.9
	225	XRFUT 150 225 F	330	585	55	3.6
	300	XRFUT 150 300 F	330	660	55	4.1
	450	XRFUT 150 450 F	330	810	55	6.6
	600	XRFUT 150 600 F	330	960	55	7.8
225	100	XRFUT 225 100 F	405	460	55	3.9
	150	XRFUT 225 150 F	405	510	55	3.8
	300	XRFUT 225 300 F	405	660	55	4.7
	450	XRFUT 225 450 F	405	810	55	7.8
	600	XRFUT 225 600 F	405	960	55	9.1
300	100	XRFUT 300 100 F	480	460	55	4.1
	150	XRFUT 300 150 F	480	510	55	4.5
	225	XRFUT 300 225 F	480	585	55	5.0
	450	XRFUT 300 450 F	480	810	55	8.9
	600	XRFUT 300 600 F	480	960	55	10.3
450	100	XRFUT 450 100 F	690	580	55	8.3
	150	XRFUT 450 150 F	690	630	55	9.2
	225	XRFUT 450 225 F	690	705	55	10.2
	300	XRFUT 450 300 F	690	780	55	11.2
	600	XRFUT 450 600 F	690	1080	55	15.3
600	100	XRFUT 600 100 F	840	580	55	10.2
	150	XRFUT 600 150 F	840	630	55	11.0
	225	XRFUT 600 225 F	840	705	55	12.2
	300	XRFUT 600 300 F	840	780	55	13.4
	450	XRFUT 600 450 F	840	930	55	15.8

Weights

All weights given are in kilograms (kg) and are for hot dip galvanised G finish

To obtain the appropriate component weight in other finishes, multiply the given weight by the following factors :

Deep galvanised (D) x 1.06

Stainless steel (S) x 0.94

Key : Replace the letter shown in red with your choice from the following options :

F = Finish : **G** (hot dip galvanised after manufacture),
D (deep galvanised), **S** (stainless steel)

All dimensions (mm) are nominal

➔ XRF equal tees : see p. 90

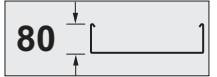

■ Dimensions and weights

Dimensions

Cat. No. XRFX **W F**

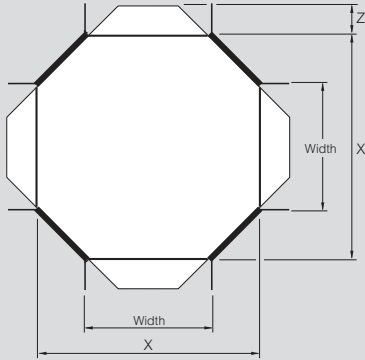

X = Length of fitting from each end (excluding integral coupler)
Z = End extension of integral coupler

Cat. Nos.	Width	X	Z	Weight (kg)
XRFX 100 F	100	460	55	2.7
XRFX 150 F	150	510	55	4.3
XRFX 225 F	225	585	55	5.5
XRFX 300 F	300	660	55	6.8
XRFX 450 F	450	930	55	16.1
XRFX 600 F	600	1080	55	22.1

Weights

All weights given are in kilograms (kg) and are for hot dip galvanised G finish

To obtain the appropriate component weight in other finishes, multiply the given weight by the following factors :

Deep galvanised (D) x 1.06
Stainless steel (S) x 0.94

■ Assembly

Coupling detail

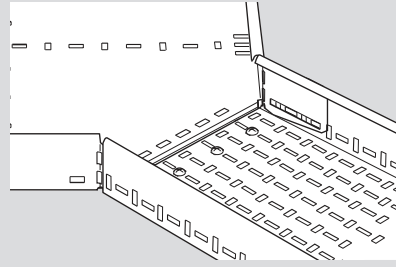

4 way crosspiece to straight length coupling

4 way crosspieces have integral couplers which fit into straight lengths whether they have been cut to length or not, without the need for further drilling

Each 4 way crosspiece to length joint is secured with M6 x 12 bolts (roofing or pan head), nuts and washers, **p. 85**. Fasteners are not included

Minimum number of fasteners per joint :

Widths up to 225 = 2

Widths 300 to 600 = 3

Fastener finishes

For 4 way crosspieces with G and D finishes, fasteners are galvanised or zinc plated. For 4 way crosspieces with S finish, fasteners are stainless steel

Minimum bend radius for cables

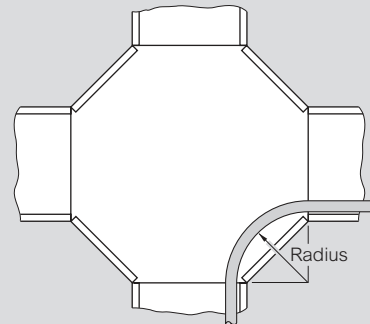

Width (mm)	Radius (mm)
100 to 300	180
450 and 600	240

Key : Replace the letter shown in red with your choice from the following options :

F = Finish : **G** (hot dip galvanised after manufacture),
D (deep galvanised), **S** (stainless steel)

All dimensions (mm) are nominal

Swifts® XRF extra heavy duty fittings

straight reducers

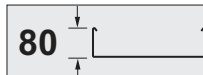

■ Dimensions and weights

Dimensions

Cat. No. XRFR **W K F**

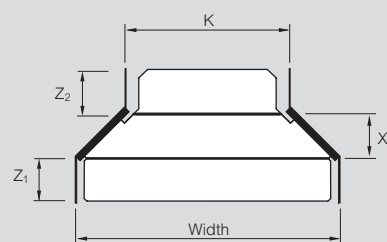

X = Length of fitting from each end (excluding integral coupler)

Z₁ = End extension of integral coupler

Z₂ = End extension of integral coupler

Width	Width (K)	Cat. Nos.	Dimensions (mm)			Weight (kg)
			X	Z ₁	Z ₂	
150	100	XRFR 150 100 F	100	55	55	0.8
225	100	XRFR 225 100 F	100	55	55	0.8
	150	XRFR 225 150 F	100	55	55	0.9
300	100	XRFR 300 100 F	150	55	55	1.2
	150	XRFR 300 150 F	100	55	55	1.0
	225	XRFR 300 225 F	100	55	55	1.1
450	100	XRFR 450 100 F	250	55	55	2.0
	150	XRFR 450 150 F	150	55	55	1.5
	225	XRFR 450 225 F	150	55	55	1.6
	300	XRFR 450 300 F	100	55	55	1.5
600	100	XRFR 600 100 F	300	55	55	2.7
	150	XRFR 600 150 F	250	55	55	2.5
	225	XRFR 600 225 F	200	55	55	2.2
	300	XRFR 600 300 F	150	55	55	2.1
	450	XRFR 600 450 F	100	55	55	2.3

To create the Cat. No., add the main run width (W), the reduced run width (K) and the finish (F)

Example :

For a hot dip galvanised reducer reducing from 300 mm to 150 mm : XRFR 300 150 G

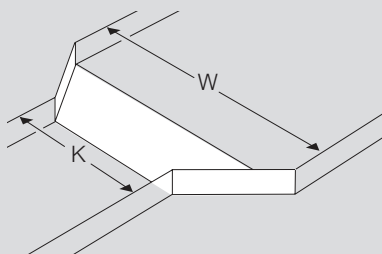

Weights

All weights given are in kilograms (kg) and are for hot dip galvanised G finish

To obtain the appropriate component weight in other finishes, multiply the given weight by the following factors :

Deep galvanised (D) x 1.06

Stainless steel (S) x 0.94

■ Assembly

Coupling detail

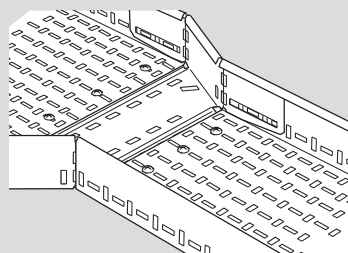

Reducers to straight length coupling

Reducers have integral couplers which fit into straight lengths whether they have been cut to length or not, without the need for further drilling

Each reducer to length joint is secured with M6 x 12 bolts (roofing or pan head), nuts and washers, **p. 85**. Fasteners are not included

Minimum number of fasteners per joint :

Widths up to 225 = 2

Widths 300 to 600 = 3

Fastener finishes

For straight reducers with G and D finishes, fasteners are galvanised or zinc plated. For straight reducers with S finish, fasteners are stainless steel

Key : Replace the letter shown in red with your choice from the following options :

F = Finish : **G** (hot dip galvanised after manufacture),
D (deep galvanised), **S** (stainless steel)

All dimensions (mm) are nominal

Swifts® cable tray supports

cantilever arms



Cantilever arms enable horizontal runs of cable tray to be mounted to vertical steel, concrete or masonry surfaces or to Swiftrack channel. They are available in ten sizes to accommodate all tray widths. Cantilever arms are of fabricated construction with a bottom flange on arms 225 mm wide and above for extra strength. Supplied singly without fasteners.

Installation (typical)

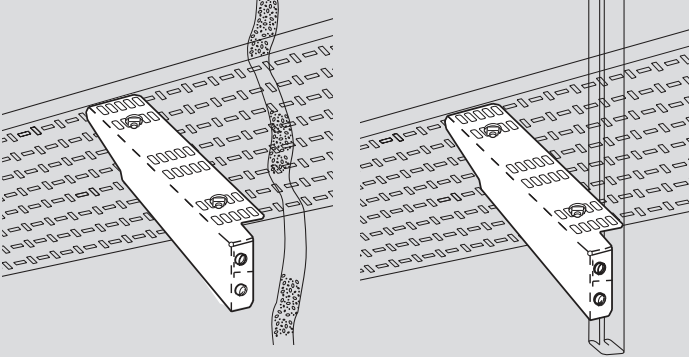

Assembly

Tray to cantilever arm using fasteners

All cantilever arms have slots in the top flange for fixing tray. Fit two fasteners for trays up to 300 mm wide. Fit three fasteners for trays 450 mm wide and above.

Tray to cantilever arm using Swiftclip

Tray can be secured to LCA cantilever arms by using Swiftclip on MRF and SRF ranges up to 300 mm wide. Fit one clip for 50 mm wide. Fit two clips for 75 to 300 mm wide trays. Clips should be fitted towards sides of tray in alternate directions. See **p. 50** for further details.

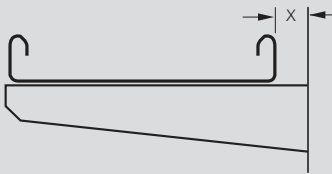

Note

If covers are fitted the clearance to the vertical support face must be approximately 40 mm (x), however for access to fit cover clips a larger clearance may be required when the vertical support is a solid face.

Cantilever arm to vertical support

All cantilever arms have two 11 mm Ø holes for M10 fasteners (not included).

Cat. Nos. LCA 50 to LCA 150 may be fitted using the top fixing hole only.

When fixing to Swiftrack channel use grade 8.8 setscrews, form A flat washers and channel nuts.

Fix using upper hole location. Lower hole has bendable tab to stop rotation if required.

When fitting LCA 100 to LCA 300 cantilever arms to Swiftrack each fixing point should be fitted with Cat. No. SB506/10 square washer see **p. 111** to prevent distortion.

Key : Replace the letter shown in red with your choice from the following options :

- F = Finish : **G** (hot dip galvanised after manufacture), **D** (deep galvanised), **PG** (pre-galvanised steel), **S** (stainless steel), **E** (powder coated black RAL 9005)

Assembly (continued)

Fasteners (not included)

For G, D and PG finish

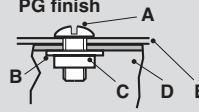

For S finish

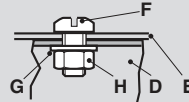

- A M6 x 12 roofing bolt
- B Roofing washer
- C M6 square nut
- D Cantilever arm
- E Straight length
- F M6 x 12 panhead screw
- G M6 form A washer
- H M6 hexagon nut

Fastener finishes

For straight lengths with G, D and PG finishes, fasteners are galvanised or zinc plated. For straight lengths with S finish, fasteners are stainless steel.

For straight lengths with E finish, the choice of material for fasteners will depend on the installation environment. For further information contact us on +44 (0) 345 605 4333.

Cat. Nos.	Recommended safe working load, kgf ⁽¹⁾
LCA 50 F	30
LCA 75 F	30
LCA 100 F	60
LCA 150 F	60
LCA 225 F	100
LCA 300 F	100
LCA 450 F	150
LCA 600 F	300
LCA 750 F	300
LCA 900 F	300

(1) Per cantilever arm for load uniformly distributed across complete arm using two fixing holes. Safety factor: 2.

All dimensions (mm) are nominal.

→ Straight lengths : see p. 36, 46, 64, 84

→ Swiftrack channel support : see p. 106-115

Swifts® cable tray supports

cantilever arms (continued)



■ Dimensions and weights

Dimensions

Cat. No. LCA **W F**

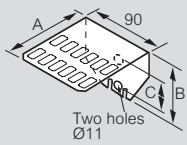

50 to 75 mm
tray widths

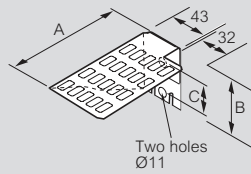

100 to 150 mm
tray widths

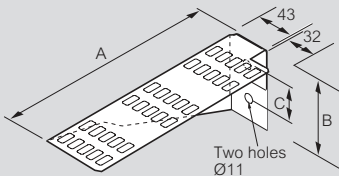

225 to 300 mm
tray widths

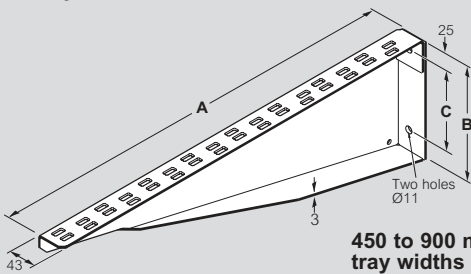

450 to 900 mm
tray widths

Cat. Nos.	Width (W)	A	B	C	Weight (kg)
LCA 50 F	50	60	65	30	0.2
LCA 75 F	75	92	65	30	0.2
LCA 100 F	100	120	74	40	0.2
LCA 150 F	150	170	74	40	0.3
LCA 225 F	225	245	100	45	0.4
LCA 300 F	300	320	100	45	0.5
LCA 450 F	450	490	120	75	1.2
LCA 600 F	600	640	180	125	2.6
LCA 750 F	750	790	230	175	4.2
LCA 900 F	900	940	280	225	5.7

Weights

All weights given are in kilograms (kg) and are for hot dip galvanised G finish

To obtain the appropriate component weight in other finishes, multiply the given weight by the following factors :

Deep galvanised (D)	x 1.06
Stainless steel (S)	x 0.94
Pre-galvanised (PG)	x 0.96
Powder coated (E)	x 0.97

Key : Replace the letter shown in red with your choice from the following options :

F = Finish : **G** (hot dip galvanised after manufacture),
D (deep galvanised), **PG** (pre-galvanised steel),
S (stainless steel), **E** (powder coated)

All dimensions (mm) are nominal

→ Straight lengths : see p. 36, 46, 64, 84

→ Swiftrack channel support : see p. 106-115

Swifts® cable tray supports

overhead hangers



Overhead hangers are suitable for supporting all cable tray ranges up to 150 mm wide. They enable tray to be supported from a single M10 threaded rod giving easy access for laying cables from one side of the tray only

Supplied singly without fasteners

Installation (typical)

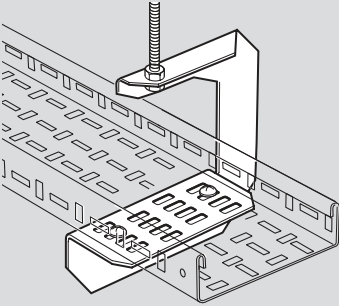

Assembly

Overhead hanger to threaded rod

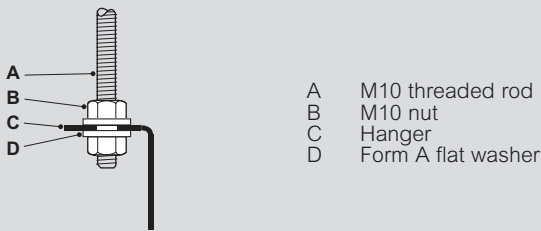

- A M10 threaded rod
- B M10 nut
- C Hanger
- D Form A flat washer

Tray to overhead hanger using Swiftclip

Tray can be secured to overhead hangers by using Swiftclip on MRF and SRF ranges up to 150 mm wide
 Fit one clip for 50 mm wide
 Fit two clips for 75 to 150 mm wide trays
 Clips should be fitted towards sides of tray in alternate directions
 See p. 50 for further details

Tray to overhead hanger using fasteners

Fasteners (not included)

For G, D and PG finish

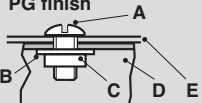

- A M6 x 12 roofing bolt
- B Roofing washer
- C M6 square nut
- D Hanger
- E Straight length

For S finish

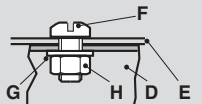

- F M6 x 12 panhead screw
- G M6 form A washer
- H M6 hexagon nut

Fastener finishes

For straight lengths with G, D and PG finishes, fasteners are galvanised or zinc plated. For straight lengths with S finish, fasteners are stainless steel

For straight lengths with E finish, the choice of material for fasteners will depend on the installation environment. For further information contact us on +44 (0) 345 605 4333

Cat. Nos.	Recommended safe working load, kg ⁽¹⁾
OH 50 F	25
OH 75 F	50
OH 100 F	50
OH 150 F	50

(1) Per hanger for load uniformly distributed across tray width
 Safety factor : 2

Dimensions and weights

Dimensions

Cat. No. OH W F

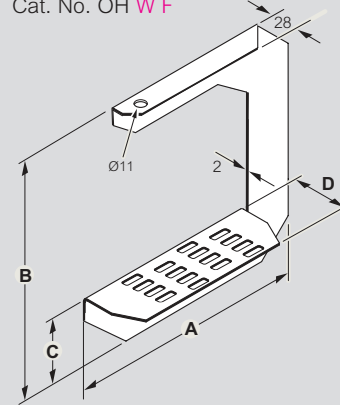

Cat. Nos.	Width (W)	A	B	C	D	Weight (kg)
OH 50 F	50	85	151	28	68	0.2
OH 75 F	75	117	181	28	70	0.2
OH 100 F	100	146	201	52	68	0.4
OH 150 F	150	206	201	52	68	0.5

Weights

All weights given are in kilograms (kg) and are for hot dip galvanised G finish

To obtain the appropriate component weight in other finishes, multiply the given weight by the following factors :

- Deep galvanised (D) x 1.06
- Stainless steel (S) x 0.94
- Pre-galvanised (PG) x 0.96
- Powder coated (E) x 0.97

Key : Replace the letter shown in red with your choice from the following options :

- F = Finish : G (hot dip galvanised after manufacture), D (deep galvanised), PG (pre-galvanised steel), S (stainless steel), E (powder coated black RAL 9005)

All dimensions (mm) are nominal

➔ Straight lengths : see p. 36, 46, 64, 84

Swifts® cable tray supports

trapeze hangers



Trapeze hangers are suitable for use with all cable tray ranges. They enable all widths of tray to be supported from overhead threaded rods hung from ceiling brackets, Swifttrack support system or from beam clamps attached to joists or steel beams
Light duty trapeze hangers are supplied singly without fasteners

Installation (typical)

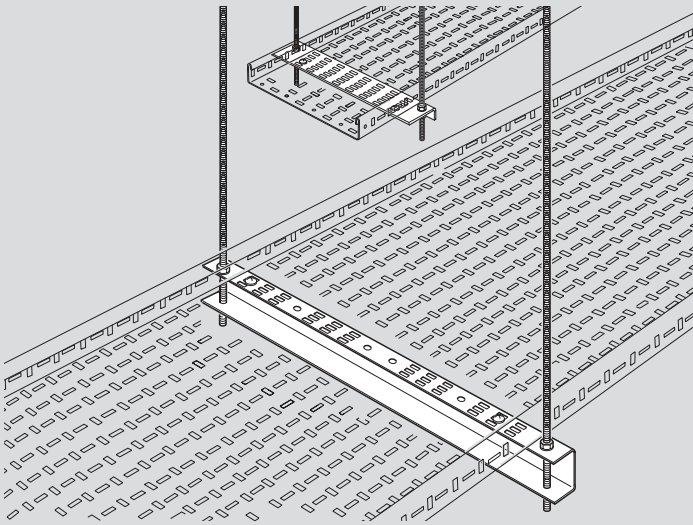

Assembly

Trapeze hanger to threaded rod

There are three alternative methods of fixing trapeze hangers to threaded rods as shown below. All three methods are applicable to trapeze hangers for 600 - 900mm widths, but only type B applies to narrower trapeze hangers. The recommended safe working load for each width and method of fixing is given in the table

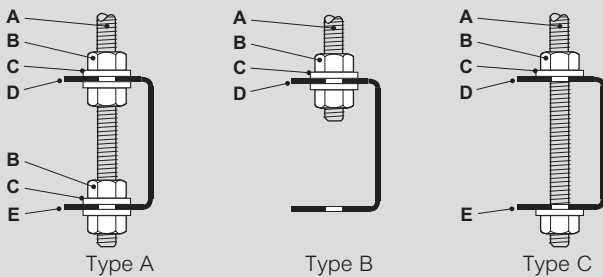

Cat. Nos.	Recommended SWL, (kgf)			A	B	C	D	E
	Type A	Type B	Type C					
LTH 50 F	-	100	-	M10 or M12 threaded rod	M10 or M12 nut	Washer	Upper flange	Lower flange
LTH 75 F	-	100	-					
LTH 100 F	-	100	-					
LTH 150 F	-	100	-					
LTH 225 F	-	150	-					
LTH 300 F	-	150	-					
LTH 450 F	-	300	-					
LTH 600 F	500	300	150					
LTH 750 F	500	300	150					
LTH 900 F	500	300	150					

1 : Per hanger for load uniformly distributed across complete hanger
Safety factor : 2

Key : Replace the letter shown in red with your choice from the following options :

F = Finish : **G** (hot dip galvanised after manufacture), **D** (deep galvanised), **PG** (pre-galvanised steel), **S** (stainless steel), **E** (powder coated black RAL 9005)

Assembly (continued)

Tray to trapeze hanger using Swiftclip

Tray can be secured to trapeze hangers by using Swiftclip on MRF and SRF ranges up to 300 mm wide
Fit one clip for 50 mm wide
Fit two clips for 75 to 300 mm wide trays
Clips should be fitted towards sides of tray in alternate directions
See p. 50 for further details

Tray to trapeze hanger using fasteners

For G, D and PG finish

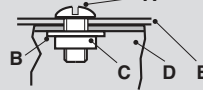

For S finish

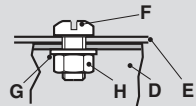

Fasteners (not included)

- A M6 x 12 roofing bolt
- B Roofing washer
- C M6 square nut
- D Hanger
- E Straight length
- F M6 x 12 panhead screw
- G M6 form A washer
- H M6 hexagon nut

Fastener finishes

For straight lengths with G, D and PG finishes, fasteners are galvanised or zinc plated. For straight lengths with S finish, fasteners are stainless steel

For straight lengths with E finish, the choice of material for fasteners will depend on the installation environment. For further information contact us on +44 (0) 345 605 4333

Dimensions and weights

Dimensions

Cat. No. LTH **W F**

50-100 mm tray width

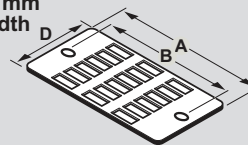

600-900 mm tray width

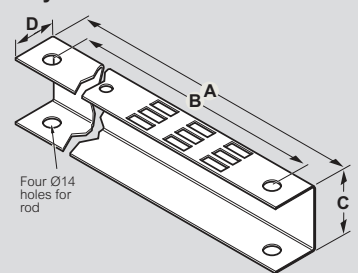

150-450 mm tray width

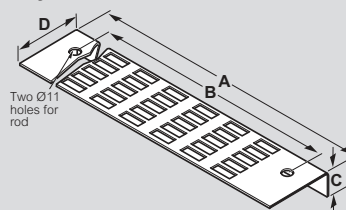

Cat. Nos.	Width (W)	A	B	C	D	Rod size	Weight (kg)
LTH 50 F	50	130	105	-	71	M10	0.1
LTH 75 F	75	155	130	-	84	M10	0.2
LTH 100 F	100	180	155	-	84	M10	0.2
LTH 150 F	150	230	205	25	75	M10	0.2
LTH 225 F	225	305	280	25	75	M10	0.3
LTH 300 F	300	380	355	25	75	M10	0.4
LTH 450 F	450	530	505	40	45	M10	0.7
LTH 600 F	600	700	660	60	45	M12	1.6
LTH 750 F	750	850	810	70	45	M12	2.1
LTH 900 F	900	1000	960	80	45	M12	2.7

Weights

All weights given are in kilograms (kg) and are for hot dip galvanised G finish

To obtain the appropriate component weight in other finishes, multiply the given weight by the following factors :

- Deep galvanised (D) x 1.06
- Stainless steel (S) x 0.94
- Pre-galvanised (PG) x 0.96
- Powder coated (E) x 0.97

All dimensions (mm) are nominal

→ Straight lengths : see p. 36, 46, 64, 84

Swifts® cable tray supports

stand-off brackets



Stand-off brackets are suitable for supporting horizontal or vertical runs of cable tray when fitted to vertical steel, concrete or masonry surfaces or Swifttrack channel. They are also ideal for floor mounted tray installations

Brackets are available in a range of widths to suit all tray types and sizes; widths 450 mm and above being formed in a 'Z' section for extra strength. Supplied singly without fasteners

Installation (typical)

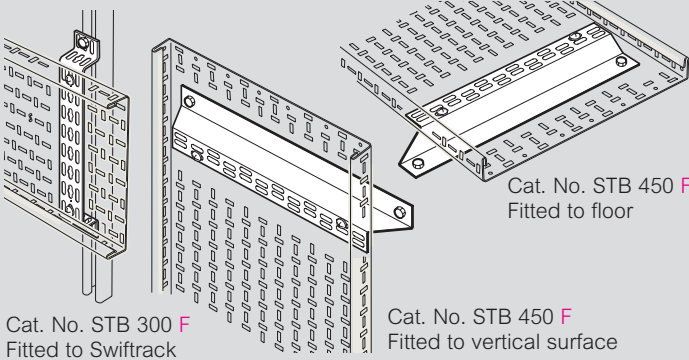

Assembly

Stand-off bracket to support

50-300 mm tray width

450 mm tray width

600-900 mm tray width

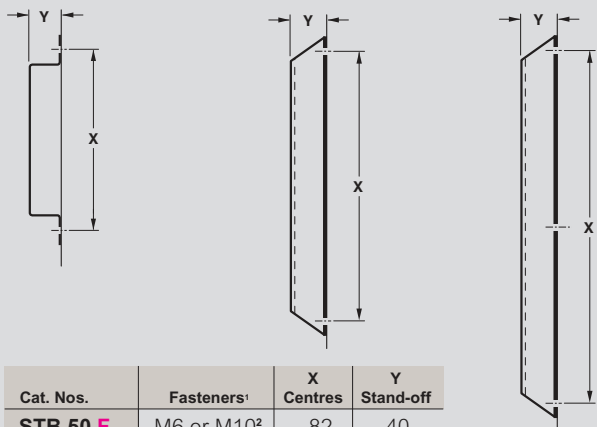

Cat. Nos.	Fasteners ¹	X Centres	Y Stand-off
STB 50 F	M6 or M10 ²	82	40
STB 75 F	M6 or M10 ²	120	40
STB 100 F	M6 or M10 ²	157	40
STB 150 F	M6 or M10 ²	195	40
STB 225 F	M6 or M10 ²	273	40
STB 300 F	M6 or M10 ²	349	40
STB 450 F	M10	485	60
STB 600 F	M10	635	60
STB 750 F	M10	785	60
STB 900 F	M10	935	60

1: Type, length and finish to suit application
When fixing to Swifttrack channel use grade 8.8 setscrews, form A washers and channel nuts
2: No.12 woodscrews may be used

Tray to stand-off bracket

Fasteners (not included)

For G, D and PG finish

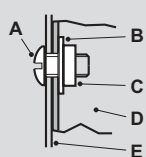

For S finish

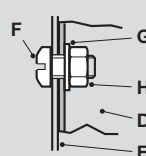

- A M6 x 12 roofing bolt
- B Roofing washer
- C M6 square nut
- D Bracket
- E Straight length
- F M6 x 12 panhead screw
- G M6 form A washer
- H M6 hexagon nut

Fastener finishes

For straight lengths with G, D and PG finishes, fasteners are galvanised or zinc plated. For straight lengths with S finish, fasteners are stainless steel. For straight lengths with E finish, the choice of material for fasteners will depend on the installation environment. For further information contact us on +44 (0) 345 605 4333

Assembly (continued)

Cat. Nos.	A	SWL (kgf)	
		horizontal tray run	vertical tray run
STB 50 F	82	40	–
STB 75 F	120	40	–
STB 100 F	157	40	–
STB 150 F	195	40	–
STB 225 F	273	100	–
STB 300 F	349	100	–
STB 450 F	485	150	150
STB 600 F	635	150	150
STB 750 F	785	150	150
STB 900 F	935	150	150

1: Per stand-off bracket for load uniformly distributed across the tray width

Dimensions and weights

Dimensions

Cat. No. STB W F

450-900 mm tray width

50-300 mm tray width

Two Ø11 holes in centre slots

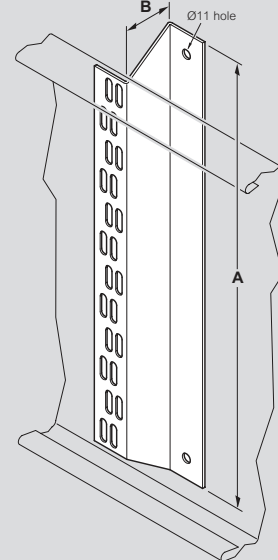
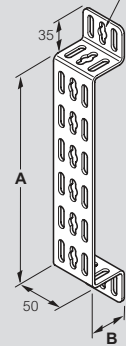

Cat. Nos.	Width (W)	A	B	Weight (kg)
STB 50 F	50	45	40	0.1
STB 75 F	75	82	40	0.1
STB 100 F	100	120	40	0.2
STB 150 F	150	157	40	0.2
STB 225 F	225	236	41	0.3
STB 300 F	300	311	41	0.4
STB 450 F	450	535	60	1.2
STB 600 F	600	685	60	1.6
STB 750 F	750	835	60	1.9
STB 900 F	900	985	60	2.3

Weights

All weights given are in kilograms (kg) and are for hot dip galvanised G finish

To obtain the appropriate component weight in other finishes, multiply the given weight by the following factors :

- Deep galvanised (D) x 1.06
- Stainless steel (S) x 0.94
- Pre-galvanised (PG) x 0.96
- Powder coated (E) x 0.97

All dimensions (mm) are nominal

→ Straight lengths : see p. 36, 46, 64, 84

→ Swifttrack channel supports : see p. 106-115

Swifts® cable tray ancillary items

dividers



Used to separate different types or groups of cable within one cable tray run
Supplied singly without fasteners

■ Installation (typical)

Cat. No. SRFDV **F**

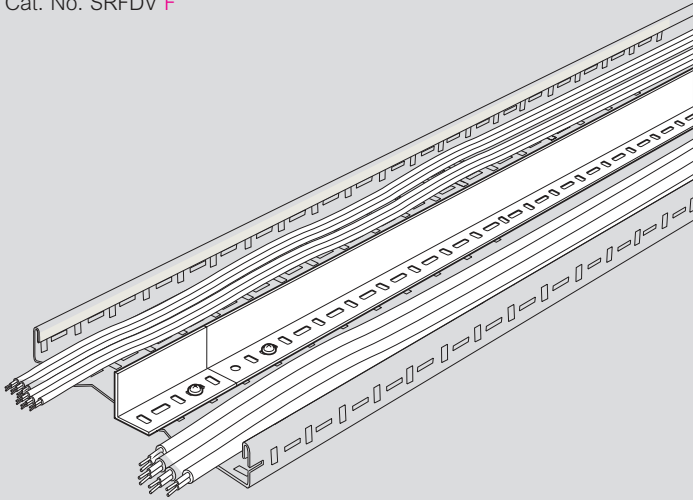

■ Assembly

Fasteners (not included)

For quantity required see table below

For G, D and E finish

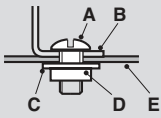

- A M6 x 12 roofing bolt
- B Divider
- C Roofing washer
- D M6 square nut
- E Straight length
- F M6 x 1 2 panhead screw
- G M6 form A washer
- H M6 hexagon nut

For S finish

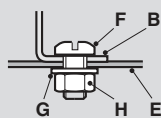

Cat. Nos.	Tray range			
	SS	MRF	SRF	XRF
SSDV F	MRFDV	SRFDV	XRFDV	
Quantity of fasteners per 3 m length	5	5	5	5

Fastener finishes

For straight lengths with G, D and PG finishes, fasteners are galvanised or zinc plated. For straight lengths with S finish, fasteners are stainless steel. For straight lengths with E finish, the choice of material for fasteners will depend on the installation environment. For further information contact us on +44 (0) 345 605 4333

Key : Replace the letter shown in red with your choice from the following options :

- F** = Finish : **G** (hot dip galvanised after manufacture), **D** (deep galvanised), **PG** (pre-galvanised steel), **S** (stainless steel), **E** (powder coated black RAL 9005)

■ Dimensions and weights

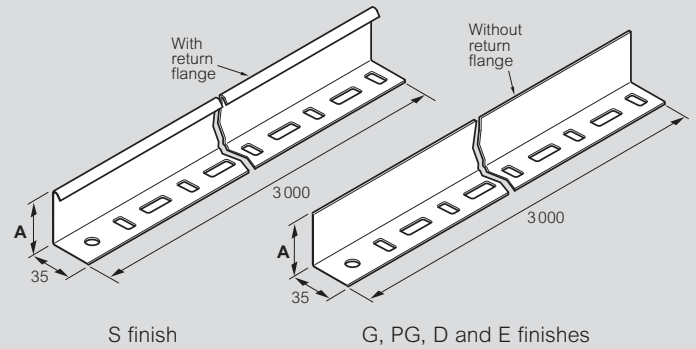

Cat. Nos.	A	G	PG	D	Weight (kg)	
					S	E
SSDV F	30	2·3	2·0	2·6	2·6	2·3
MRFDV F	30	2·3	2·1	2·6	2·6	2·3
SRFDV F	55	3·2	2·7	3·6	3·7	3·2
XRFDV F	55	3·2	2·9	3·6	3·7	3·2

All dimensions (mm) are nominal

➔ Straight lengths : see p. 36, 46, 64, 84

Swifts® cable tray ancillary items

earth continuity connector



When fixing tray, a supplementary bonding conductor for equipotential earthing may be required in certain cases and conditions. This will depend on the type of cables used, the environment and fault current on the cables. A flexible earth continuity connector is available for this purpose and is designed to fit onto all types of tray. Earth continuity connectors are supplied in bagged quantities of 20 without fasteners. Use M6 x 12 mm roofing nuts and bolts. Copper braid and copper lugs both in electroplated finish. Length between centres : 93 mm. Conductor area : 4 mm². Electroplated copper finish.

Installation (typical)

Cat. No. PTFEB

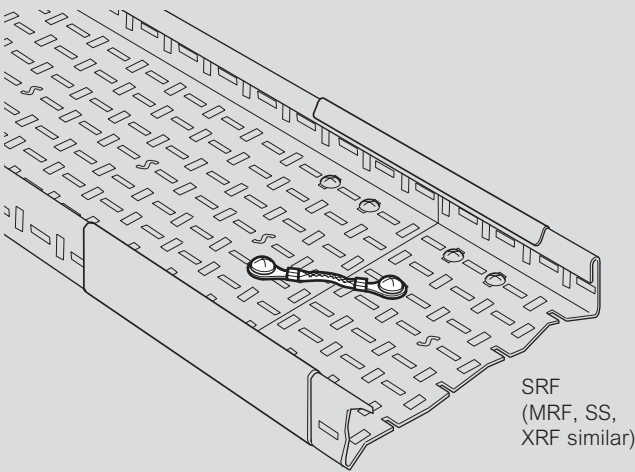

Assembly

Fasteners not included

Butt-jointed lengths

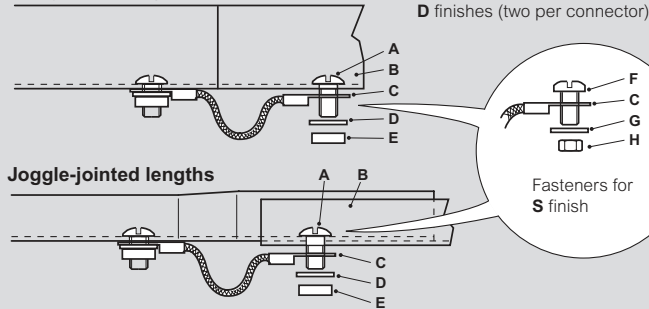

Joggle-jointed lengths

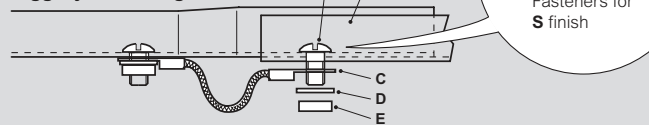

- A M6 x 12 roofing bolt
- B Tray side flange
- C Earth continuity connector
- D M6 roofing washer
- E M6 roofing nut
- F M6 x 12 pan head screw
- G M6 form A washer
- H M6 hex nut

Fastener finish

For E finish tray fasteners, contact us on +44 (0) 345 605 4333

Dimensions and weights

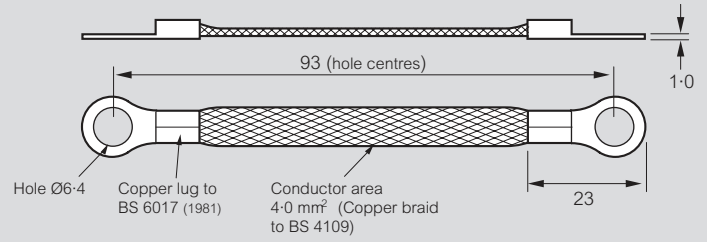

All dimensions (mm) are nominal

➔ Straight lengths : see p. 36, 46, 64, 84

Swifts® cable tray ancillary items

covers for straight lengths



Tray covers can be installed either close to the tray side flanges (closed covers) or raised above the flanges providing an air gap (ventilated covers)

Covers up to 450 mm wide have a flat top surface and are simply butt-jointed together. Covers 600 mm wide and above have dimples formed in the top surface to increase their rigidity, and are overlapped and bolted together. Each wide straight cover has an overlap tongue formed at one end to make joining simple

Covers for MRF, SRF, XRF and SS straight lengths are 3 m long with six cover clips and associated fasteners

Installation (typical)

Closed cover installations

Supplied singly with fasteners and brackets. Covers 600 mm and above are overlap jointed and dimpled for rigidity
SS light duty tray closed cover is only available in width 300 mm

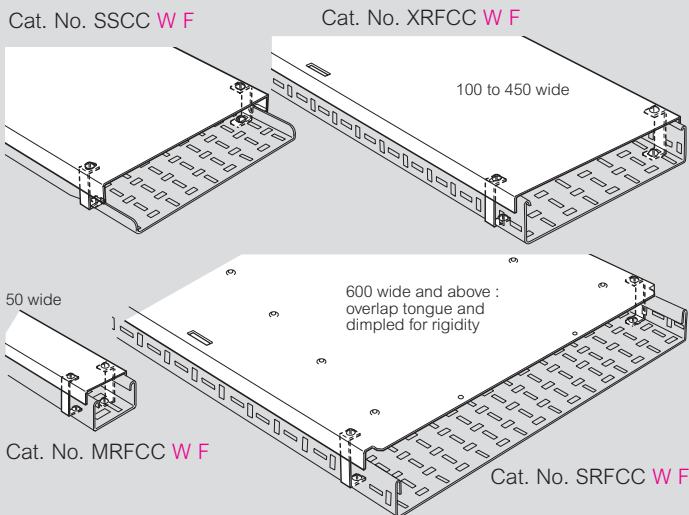

Straight ventilated cover installations

Supplied singly with fasteners. 3 m lengths
Covers 600 mm and above are overlap jointed and dimpled for rigidity
SS ventilated covers are only available in widths 75 mm and above

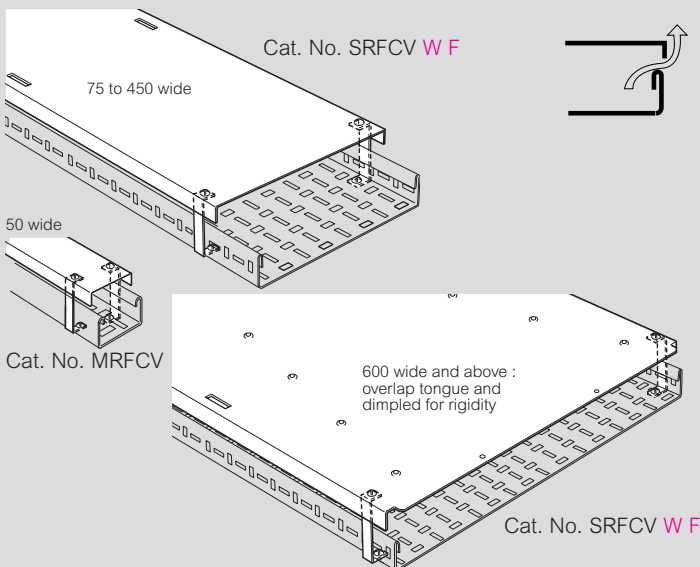

Assembly

Before fitting the covers ensure a clearance of 10 mm between the tray and the vertical support face

Closed and ventilated covers

Fit the correct size cover clips to the tray in the positions shown below

Covers with slots

Place the cover on to the clips with the slots in the cover aligned with the tapped holes in the clips and secure with the fasteners supplied

Covers without slots

Place the cover on to the clips and mark the positions of the fixing holes. Remove the cover and drill the holes. Refit the cover and secure with the fasteners supplied

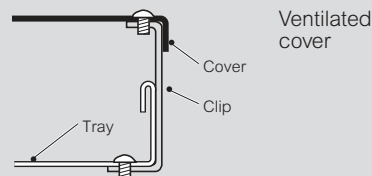
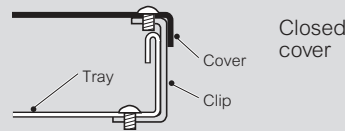

Cover clip positions

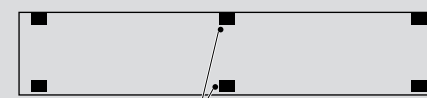

3 m lengths only

Most tray covers have slots in the top surface which determine the positions of the cover clips

For SS 50 to 150 wide covers which do not have slots, holes must be drilled in the covers on site after the clips have been fitted to the tray

Fasteners for cover clips (included)

Overlap joint (2 fasteners per joint on widths 600 and above)

For G, D and PG finish

For S finish

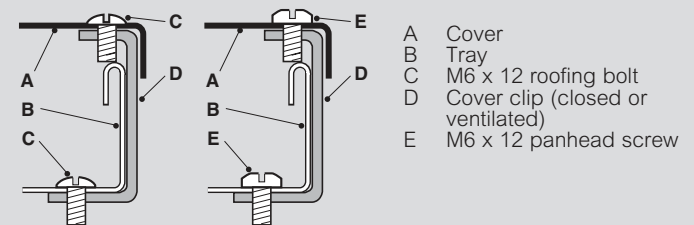

- A Cover
- B Tray
- C M6 x 12 roofing bolt
- D Cover clip (closed or ventilated)
- E M6 x 12 panhead screw

Fastener finishes

For covers with G, D and PG finishes, fasteners are galvanised or zinc coated, except for retaining nut which is 'Dacromet' coated. For covers with S finish, fasteners are stainless steel, except for retaining nut which is 'Xylan' coated. For covers with E finish, the choice of material for fasteners will depend on the installation environment. For further information contact us on +44 (0) 345 605 4333

Cat. Nos.		Tray range			
		SS	MRF	SRF	XRF
	Closed covers	SSCCWF	MRFCCWF	SRFCCWF	XRFCCWF
	Ventilated covers	SSCVWF	MRFVCWF	SRFCVWF	XRFVCWF

Key : Replace the letter shown in red with your choice from the following options :

- F = Finish : G (hot dip galvanised after manufacture), D (deep galvanised), PG (pre-galvanised steel), S (stainless steel), E (powder coated black RAL 9005)

All dimensions (mm) are nominal

Swifts® cable tray ancillary items

covers for straight lengths (continued)



■ Assembly (continued)

Joining covers

For covers 600 mm wide and above with overlap joints fit the first cover as above. Fit U-shaped retaining nuts over the holes in the overlap tongue. Fit the second cover in the same way as the first, ensuring that the straight (butt) end overlaps the tongue on the first cover. Insert fasteners through the slots in the end of the second cover into the U-shaped retaining nuts on the tongue of the first cover and secure.

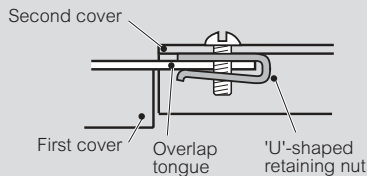
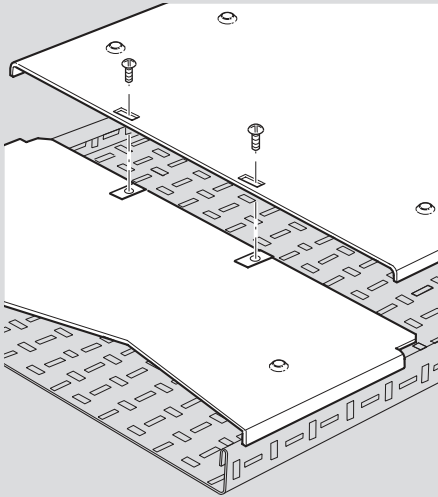

When a fitting cover has an overlap tongue, it should be fitted on top of the tongue on the straight cover. Fit U-shaped retaining nuts over the holes in the straight cover tongue. Insert fasteners through the holes in the fitting cover tongue into the U-shaped retaining nuts and secure.

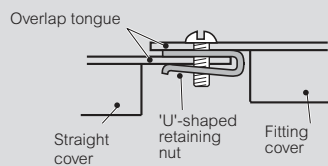

Fasteners for cover overlap joints (included)

Overlap joint (2 fasteners per joint on widths 600 and above)

For G, D and PG finish

For S finish

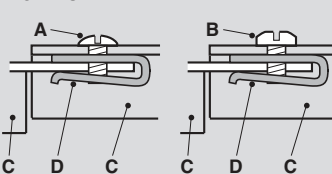

- A M6 x 12 roofing bolt
- B M6 x 12 panhead screw
- C Straight length cover
- D U-shaped retaining nut

Fastener finishes

For covers with G, D and PG finishes, fasteners are galvanised or zinc coated, except for retaining nut which is 'Dacromet' coated. For covers with S finish, fasteners are stainless steel, except for retaining nut which is 'Xylan' coated. For covers with E finish, the choice of material for fasteners will depend on the installation environment. For further information contact us on +44 (0) 345 605 4333

Key : Replace the letter shown in red with your choice from the following options :

- F = Finish : **G** (hot dip galvanised after manufacture), **D** (deep galvanised), **PG** (pre-galvanised steel), **S** (stainless steel), **E** (powder coated black RAL 9005)

■ Dimensions and weights

Covers

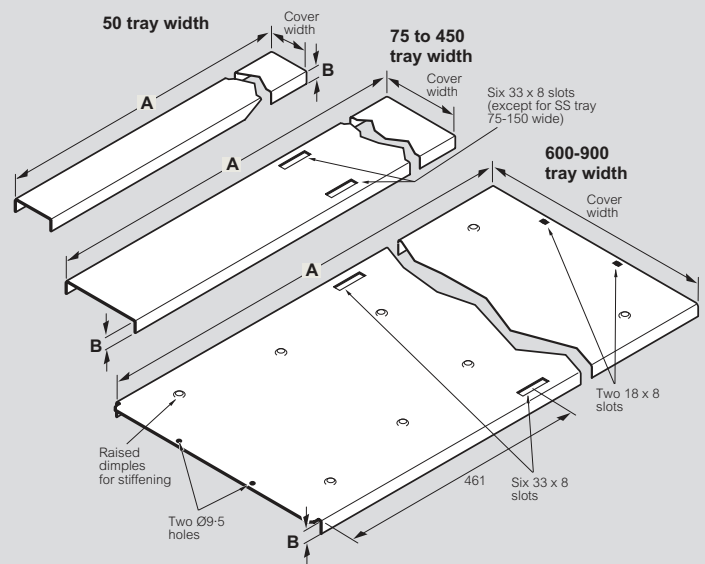

Tray width	Cover width	A	B	Weight (kg)
50	63	3 000	12	2.1
75	88	3 000	12	2.7
100	113	3 000	12	3.4
150	163	3 000	12	4.6
225	238	3 000	12	6.6
300	313	3 000	22	13.1
450	463	3 000	22	18.7
600	613	3 000	22	24.4
750	763	3 000	22	30.1
900	913	3 000	22	35.7

Cover clips

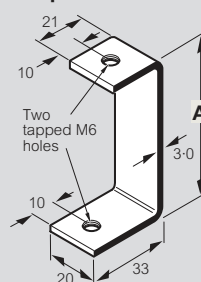

Nom. Weight : 1.0 kg per 20 clips

Tray range	Tray width	CC	A	CV
SS	50-225	-		38.5
	300	38.5		63.5
MRF	ALL	38.5		63.5
SRF	ALL	63.5		93.5
XRF	ALL	93.5		-

Weights

All weights given are in kilograms (kg) and are for hot dip galvanised G finish

To obtain the appropriate component weight in other finishes, multiply the given weight by the following factors :

- Deep galvanised (D) x 1.06
- Stainless steel (S) x 0.94
- Pre-galvanised (PG) x 0.96
- Powder coated (E) x 0.97

All dimensions (mm) are nominal

Swifts® cable tray ancillary items

covers for fittings



Covers are supplied to fit the fittings of all cable tray ranges with the exception of MRF and SRF adjustable bends and adjustable risers. They can be installed either close to the fitting side flanges (closed cover) or, for all tray ranges except XRF, raised above the flanges providing an air gap (ventilated cover).
Covers for fittings up to 450 mm wide are simply butt-joined to straight length covers. To increase the rigidity of fitting covers of 600 mm width and above, they are joined to straight covers by being overlapped and bolted together. To make this simple, fitting covers have extended overlap tongues with long slots at all joints which are 600 mm wide or greater.

Installation (typical)

Closed cover installations

Supplied singly with fasteners and brackets. Covers 600 mm and above are overlap jointed and dimpled for rigidity. SS light duty tray closed cover is only available in 300 mm width.

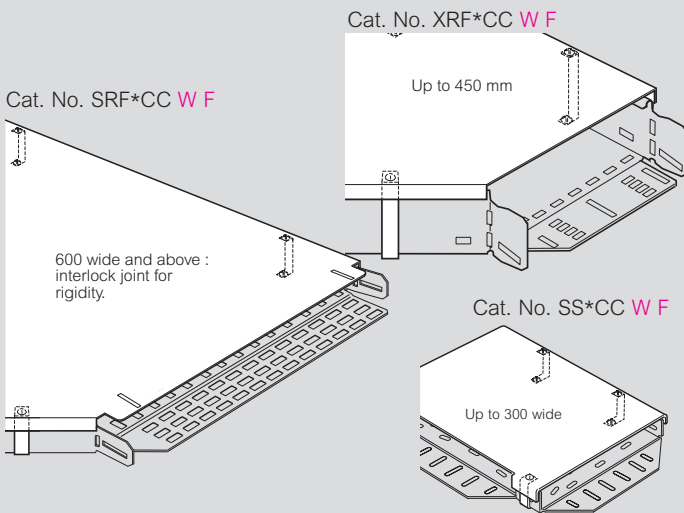

Ventilated cover installations

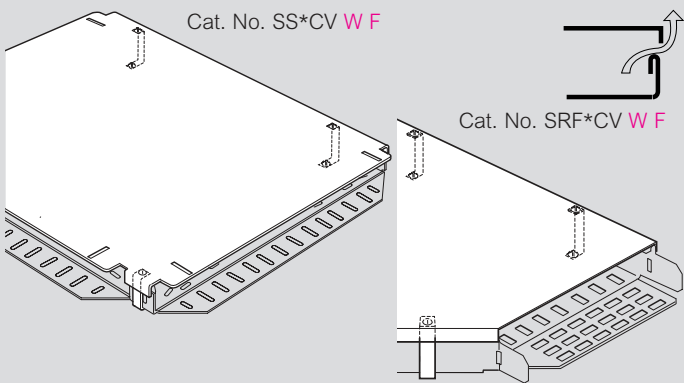

Cat. Nos.		Tray range	
		SS	MRF
	Closed covers	SS*CC W F	MRF*CC W F
	Ventilated covers	SS*CV W F	MRF*CV W F
Cat. Nos.		SRF	XRF
		Closed covers	SRF*CC W F
	Ventilated covers	SRF*CV W F	XRF*CV W F

The Cat. Nos. should be completed with the inclusion of the fitting reference where indicated (*).

Example :

A closed cover for an SRF equal tee 300 mm hot dip galvanised – SRFTCC 300 G width

Key : Replace the letter shown in red with your choice from the following options :

- F** = Finish : **G** (hot dip galvanised after manufacture), **D** (deep galvanised), **PG** (pre-galvanised steel), **S** (stainless steel), **E** (powder coated black RAL 9005)

Assembly

Cover clip positions

Fitting covers are supplied with slots for the cover clip fasteners pre-drilled in the appropriate positions.

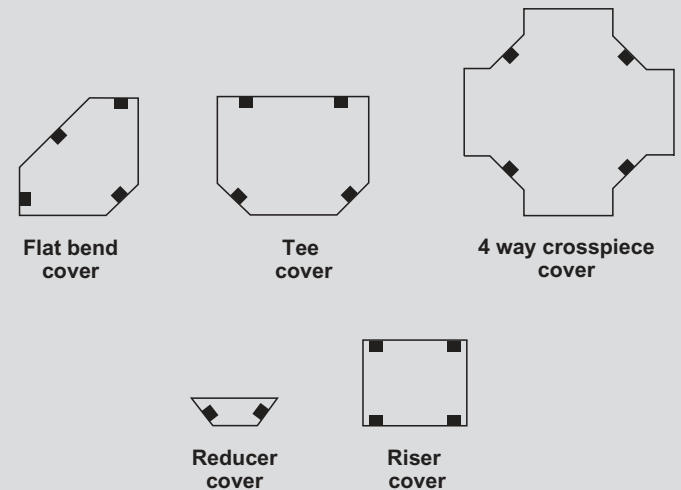

For cover clip dimensions and weights, p. 102

Closed and ventilated cover assembly

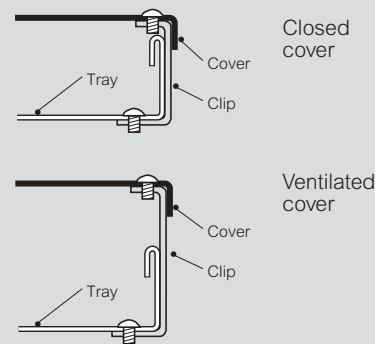

To fit covers either as closed or ventilated, place the cover in position over the fitting and mark the position of the cover clip slots in the cover on to the fitting.

Remove the cover and fit the appropriate cover clips in the marked positions on the fitting.

Fit the cover over the cover clips. Insert fasteners through the covers into the tapped holes in the cover clips. Tighten the fasteners.

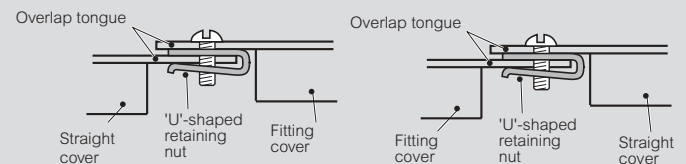

Joining covers

Wide fitting covers (600 mm or over) with overlap tongues on the joining faces can be joined to either end of a straight length cover.

To join a wide fitting cover to a straight cover with an overlap tongue, push 'U'-shaped retaining nuts over the holes in the straight cover tongue. Fit the fitting cover with its tongue overlapping the straight cover tongue. Insert fasteners through the holes in the fitting cover tongue and into the retaining nuts. Tighten the fasteners.

To join a wide fitting cover to a straight cover which has a straight (butt) end, push 'U'-shaped retaining nuts over the holes in the fitting cover overlap tongue. Fit the fitting cover with its overlap tongue under the end of the straight cover. Insert fasteners through the slots in the end of the straight cover and into the retaining nuts. Tighten the fasteners.

All dimensions (mm) are nominal



■ Assembly (continued)

Fasteners (included)

2 fasteners per clip

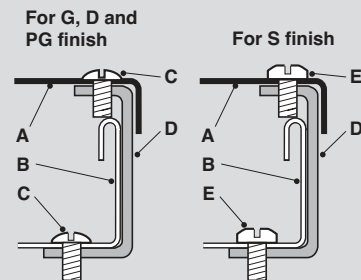

Overlap joint (2 fasteners per joint on widths 600 and above)

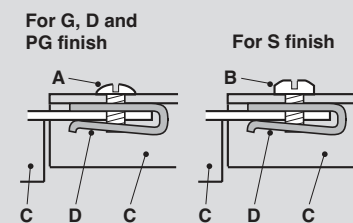

- A Cover
- B Tray
- C M6 x 12 roofing bolt
- D Cover clip (closed or ventilated)
- E M6 x 12 panhead screw

Fastener finishes

For covers with G, D and PG finishes, fasteners are galvanised or zinc coated, except for retaining nut which is 'Dacromet' coated. For covers with S finish, fasteners are stainless steel, except for retaining nut which is 'Xylan' coated. For covers with E finish, the choice of material for fasteners will depend on the installation environment. For further information contact us on +44 (0) 345 605 4333

■ Dimensions and weights

For information on dimensions and weights for specific fitting covers, contact us on +44 (0) 345 605 4333

Key : Replace the letter shown in red with your choice from the following options :

- F = Finish : **G** (hot dip galvanised after manufacture),
- D** (deep galvanised), **PG** (pre-galvanised steel),
- S** (stainless steel), **E** (powder coated black RAL 9005)

All dimensions (mm) are nominal

Swifts® cable tray ancillary items

fishplates



Fishplates are designed for use when joining larger widths of MRF and SRF cable tray and all widths of SS cable tray which have been cut to length

They fit across the underside of the tray joint to provide added strength and increase the safe working load. They also greatly enhance the lateral rigidity of the joint and prevent unevenness in the bed between adjacent trays. Supplied singly without fasteners

Installation (typical)

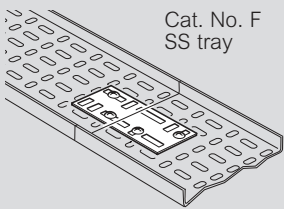

Cat. No. F
SS tray

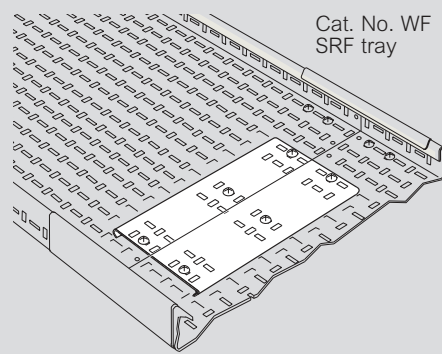

Cat. No. WF
SRF tray

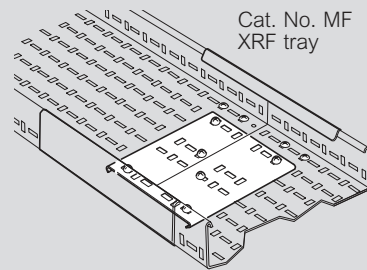

Cat. No. MF
XRF tray

Tray range	Tray width	Cat. No.
SS	50–300	F F
MRF	450–600	WF F
SRF	450–900	WF F
XRF ¹	225	F F
	300	MF F
	450–600	WF F

¹: Fishplates for XRF tray are only required when cable loading is in excess of 50% of maximum safe working load

Universal fishplate

Fishplates are designed for extra strength when joining cable tray beds and can also help to protect cables from cut edges

The universal fishplate can be overfolded and split at 75 mm centres when working with narrow trays
Supplied singly without fasteners

Cat. No. UF 450 F

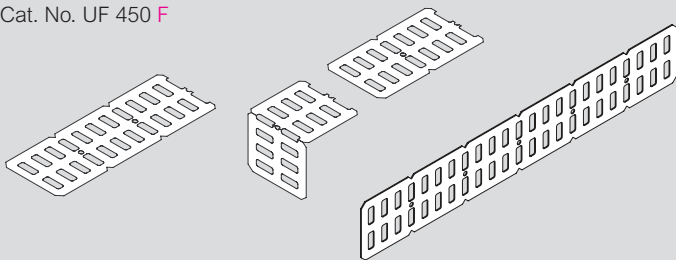

Key : Replace the letter shown in red with your choice from the following options :

F = Finish : **G** (hot dip galvanised after manufacture),
D (deep galvanised), **PG** (pre-galvanised steel),
S (stainless steel), **E** (powder coated black RAL 9005)

Assembly

Fixing positions

MRF and SRF

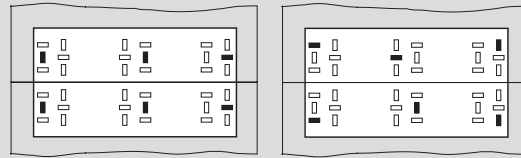

SS cut lengths

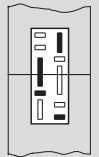

Note

Typical fastener positions shown. Use suitable aligning holes

XRF

Cat. No. F
on 225 mm

Cat. No. MF
on 300 mm

Cat. No. WF
on 450 mm

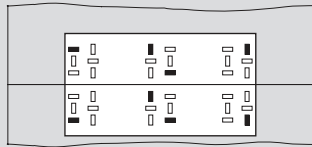
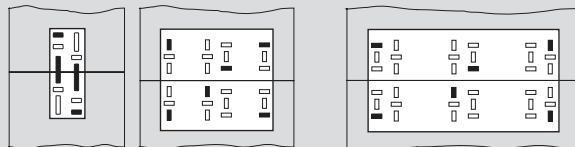

Cat. No. WF
on 600 mm

Dimensions and weights

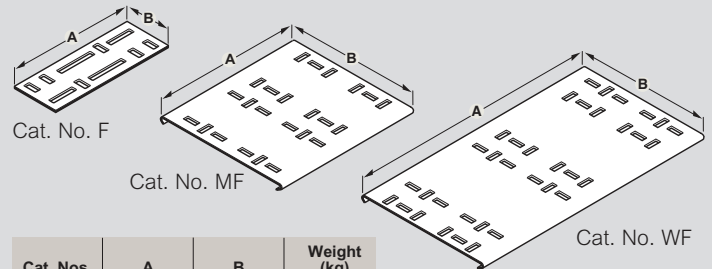

Cat. Nos.	A	B	Weight (kg)
F F	185	69	0.2
MF F	215	200	0.5
WF F	365	200	1.4

Weights

All weights given are in kilograms (kg) and are for hot dip galvanised G finish

To obtain the appropriate component weight in other finishes, multiply the given weight by the following factors :

Deep galvanised (D) x 1.06
Stainless steel (S) x 0.94
Pre-galvanised (PG) x 0.96
Powder coated (E) x 0.97

Fasteners (not included)

For G, D and PG finish

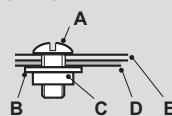

- A M6 x 12 roofing bolt
- B Roofing washer
- C M6 square nut
- D Fishplate
- E Straight length
- F M6 x 12 panhead screw
- G M6 form A washer
- H M6 hexagon nut

For S finish

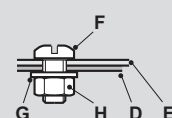

Fastener finishes

For straight lengths with G, D and PG finishes, fasteners are galvanised or zinc plated. For straight lengths with S finish, fasteners are stainless steel

For straight lengths with E finish, the choice of material for fasteners will depend on the installation environment. For further information contact us on +44 (0) 345 605 4333

All dimensions (mm) are nominal

Swiftrack® channel lengths

single channels – plain and slotted

■ Single channels – plain

Single channels are available in standard and light gauge options in 3 and 6 m lengths, supplied singly
 Standard channels are cold rolled to BS 6946 from 2.5 mm pre-galvanised mild steel to BS EN 10346 : 2009 Grade S250GD + Z275
 Light gauge channels are cold rolled from 1.5 mm pre-galvanised mild steel to BS EN 10346 : 2009 Grade S250GD + Z275
 All single channels are designed to accept channel nuts, **p. 107**

Standard

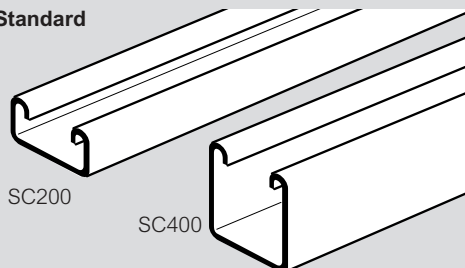

Light gauge

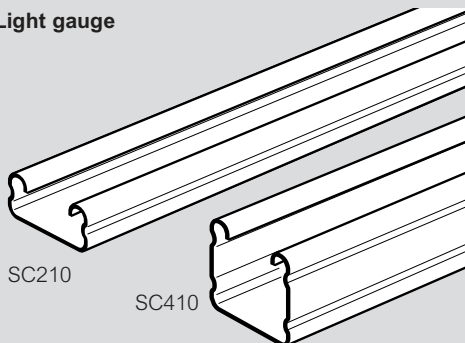

■ Dimensions and weights

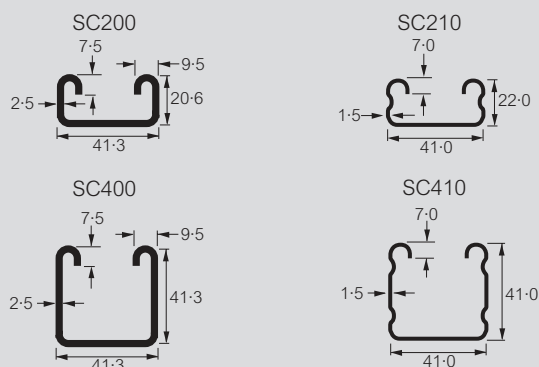

	Cat. Nos.		Weight (kg) per m
	3 m long	6 m long	
Standard Channel	SC200 3M	SC200 6M	1.8
	SC400 3M	SC400 6M	2.6
Light gauge Channel	SC210 3M	SC210 6M	1.2
	SC410 3M	SC410 6M	1.7

Cat. Nos. given are for standard finish single channel
 For alternative finishes, see opposite

■ Single channels – slotted

Slotted channels are available in standard and light gauge options in 3 and 6 m lengths, supplied singly
 Swiftrack channels conform to BS 6946

Standard

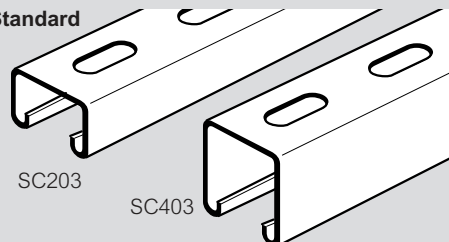

Light gauge

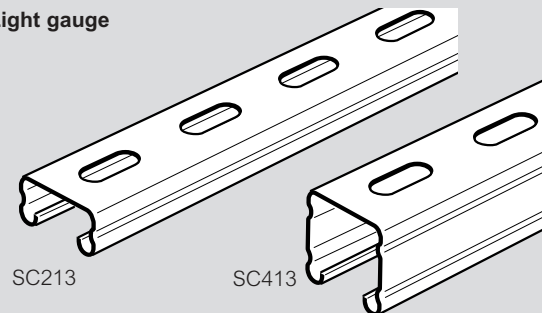

■ Dimensions and weights

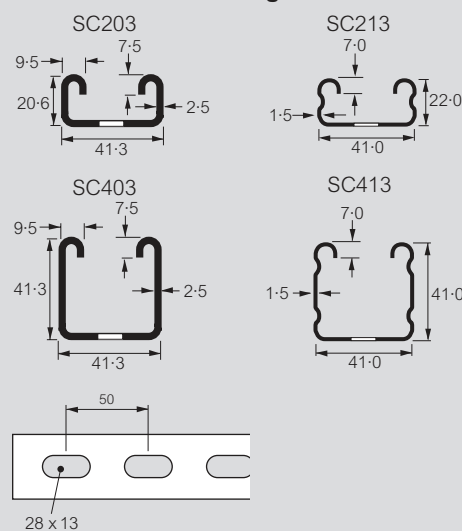

Slot pattern may differ on stainless steel channels

	Cat. Nos.		Weight (kg) per m
	3 m long	6 m long	
Standard Channel	SC203 3M	SC203 6M	1.8
	SC403 3M	SC403 6M	2.6
Light gauge Channel	SC213 3M	SC213 6M	1.2
	SC413 3M	SC413 6M	1.7

Cat. Nos. given are for standard finish single channel
 For alternative finishes see below

Weights

All weights given are in kilograms (kg) based on nominal thickness and are for pre-galvanised finish

For weights in alternative finishes contact us on +44 (0) 345 605 4333

■ Finishes and standards

Standard finish :

Pre-galvanised mild steel to BS EN 10346 : 2009 Grade S250GD + Z275 finish (structural grade)

Alternative finishes :

G Hot dip galvanised after manufacture to BS EN ISO 1461

S Stainless steel to BS EN 10088 : 2005 Grade 1.4404 (equivalent to S316L31)

All dimensions (mm) are nominal

Swiftrack® channel support system

back-to-back channels, section properties and assembly

■ Back-to-back channels

Back to back channels are available in 3 and 6 m lengths, supplied singly

Back-to-back channels are formed by spot welding together two finished single channels at 150 mm centres under controlled conditions to BS EN 1993-1-3 : 2006. All welds and spot welds are suitably protected

■ Dimensions and weights

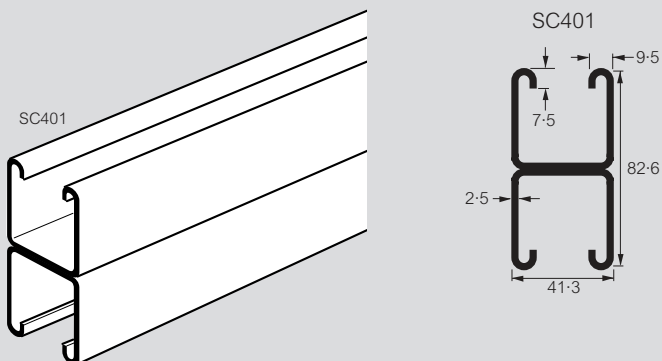

	Cat. Nos.		Weight (kg) per m
	3 m long	6 m long	
Back-to-back channel	SC401 3M	SC401 6M	5.3

Cat. Nos. given are for standard finish back-to-back channel
For alternative finishes see below

Weights

All weights given are in kilograms (kg) based on nominal thickness and are for pre-galvanised finish

For weights in alternative finishes contact us on +44 (0) 345 605 4333

■ Finishes and standards

Standard finish :

Pre-galvanised mild steel to BS EN 10346 : 2009 Grade S250GD + Z275 finish (structural grade)

Alternative finishes :

G Hot dip galvanised after manufacture to BS EN ISO 1461

S Stainless steel to BS EN 10088 : Grade 1.4404 (equivalent to S316L31)

■ Section properties

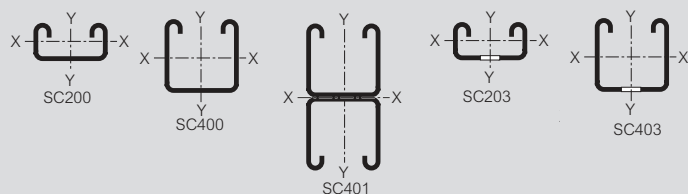

Cat. Nos.	Wt (kg/m)	A (mm ²)	I _{xx} (mm ⁴)	Z _{top} (min mm ³)	Z _{bottom} (max mm ³)	r _{xx} (mm)	I _{yy} (mm ⁴)	r _{yy} (mm)
SC200	1.8	219	10779	862	1330	7.1	49776	15.1
SC203	1.6	219	8960	794	961	6.4	49318	15.0
SC400	2.6	322	67157	2857	3772	14.5	88783	16.6
SC401	5.3	645	339300	8215	8215	23.0	177566	16.6
SC403	2.4	322	57221	2645	2909	13.3	88325	16.5

Wt = weight of section (kg/m)

A = cross-sectional area (mm²)

I_{xx} = moment of inertia = second moment of area (mm⁴)

Z_{top} = section modulus about xx axis (mm³)

Z_{bottom} = section modulus about xx axis (mm³)

r_{xx} = radius of gyration (mm)

I_{yy} = moment of inertia = second moment of area (mm⁴)

r_{yy} = radius of gyration (mm)

xx = about xx axis

yy = about yy axis

■ Assembly

Fasteners for single (plain and slotted) and back-to-back channel supplied separately

Fixing brackets to Swiftrack channel

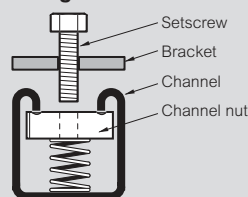

Standard fasteners for Swiftrack are high tensile hexagon head setscrews to BS 3692-8.8, these being zinc plated to BS 3382 : Part 2

Most standard Swiftrack brackets are made from 5 or 6 mm gauge steel

The use of too long a fastener will prevent proper tightening because the bolt end will foul the bottom of the channel before the head tightens down on the fitting

When fastening brackets other than Swiftrack, longer bolts may be required if the bracket thickness is greater than 8 mm

Fixing tray to Swiftrack channel

Use M10 x 16 mm high tensile hexagon head setscrews

■ Channel nuts

Channel nuts are for use with all channels and are supplied in packs of 100. For maximum load capacity M12 channel nuts should always be used

Channel nuts conform to BS 6946

Long spring

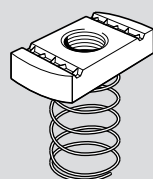

Short spring

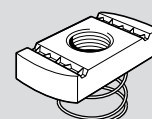

No spring

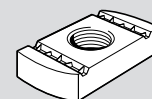

■ Dimensions and weights

Long spring

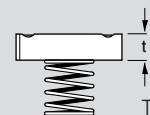

Short spring



No spring

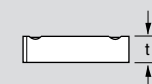

The safe working loads for zinc plated channel nuts only

Slip M10 : 3.0kN M12 : 3.5kN

Pullout M10 : 6.0kN M12 : 8.0kN

Safety Factor 3 when tested to BS 6946

Torque Tightened to M10 : 5.5 kgf.m (40ftlb)

M12 : 7.0 kgf.m (50ftlb)

	Cat. Nos.	Thread size	Depth of channel	t	Weight (kg) per 100
Long spring	PN061	M6	41	6.0	3.0
	PN081	M8	41	6.0	3.0
	PN101	M10	41	8.0	3.7
	PN121	M12	41	10.0	4.5
Short spring	PN062	M6	21	6.0	2.9
	PN082	M8	21	6.0	2.9
	PN102	M10	21	8.0	3.6
	PN122	M12	21	8.0	4.4
No spring	PN060	M6	ALL	6.0	2.8
	PN080	M8	ALL	6.0	2.8
	PN100	M10	ALL	8.0	3.5
	PN120	M12	ALL	10.0	4.3

Weights

All weights given are in kilograms (kg) based on nominal thickness, and are for zinc plated finish. For weights in stainless steel finish contact us on +44 (0) 345 605 4333

Note

Cat. Nos. given are for standard finish channel nuts, for alternative finish, see below

■ Finishes and standards

Standard finish

Zinc plated to BS 3382

G Hot dip galvanised after manufacture to BS EN ISO 1461

Alternative finish

S Stainless steel to BS EN 10088 : Grade 1.4404 (equivalent to S316L31)

All dimensions (mm) are nominal

Swiftrack® channel support system

cantilever arms

Cantilever arms are supplied singly without fasteners
 Cantilever arms conform to BS 6946

■ Dimensions and weights

Cantilever arms

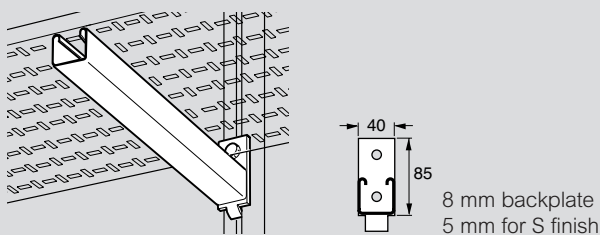

Cat. Nos.	Unit weight (kg)	Arm length (mm)	Maximum uniformly distributed load (kgf) ¹	Max. point load at outer end (kgf) ¹
SA750	0.64	150	350 ^{2,3}	303
SA751	0.85	225	350 ³	198
SA752	1.03	300	304	152
SA753	1.42	450	202	101
SA754	1.81	600	150	75
SA755	2.20	750	110	55
SA757	2.60	900	90	45

Values assume the tray or other loading medium is rigidly fixed to cantilever arm

- 1 : Based upon a load factor of 1.6 for hot dipped galvanised unrestrained condition as specified in BS EN 1993-1-3 : 2006
- 2 : Slip limits loading capacity
- 3 : Load limit is 50%

Cantilever arms, universal

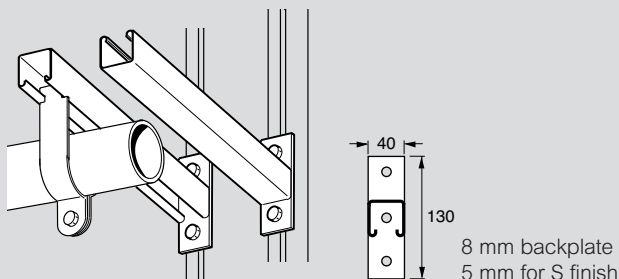

Cat. Nos.	Unit weight (kg)	Arm length (mm)	Maximum uniformly distributed load (kgf) ¹	Point load at outer end (kgf) ¹
SA760	0.64	150	700 ²	350
SA761	0.85	225	456	228
SA762	1.03	300	350	175
SA763	1.42	450	230	115
SA764	1.81	600	170	85
SA765	2.20	750	136	68
SA766	2.60	900	110	55

Values assume the tray or other loading medium is rigidly fixed to cantilever arm

- 1 : Based upon a load factor of 1.6 for hot dipped galvanised unrestrained condition as specified in BS EN 1993-1-3 : 2006
- 2 : Load limit is 50%

■ Dimensions and weights (continued)

Cantilever arms, side

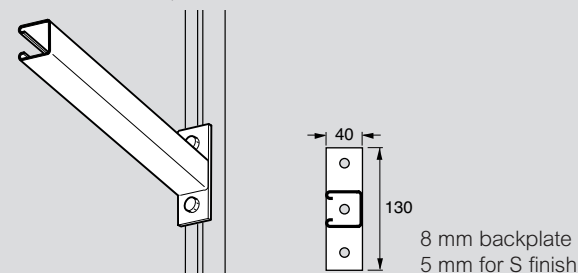

Cat. Nos.	Unit weight (kg)	Arm length (mm)
SA790	0.64	150
SA791	0.85	225
SA792	1.03	300
SA793	1.42	450
SA794	1.81	600
SA795	2.20	750
SA796	2.60	900

Cantilever arms, double channel

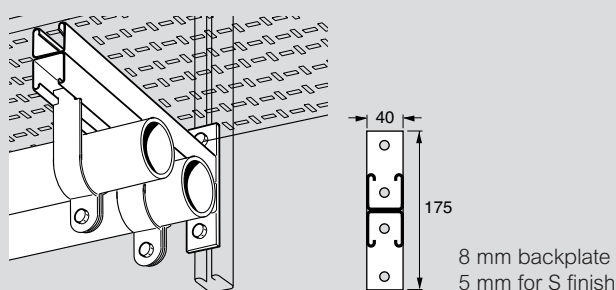

Cat. Nos.	Unit weight (kg)	Arm length (mm)	Maximum uniformly distributed load (kgf) ¹	Point load at outer end (kgf) ¹
SA770	1.14	150	700 ^{2,3}	648
SA771	1.68	225	700 ^{2,3}	420
SA772	2.02	300	650	325
SA773	2.90	450	430	215
SA774	3.78	600	320	160
SA775	4.66	750	250	125
SA776	5.60	900	200	100

Values assume the tray or other loading medium is rigidly fixed to cantilever arm

- 1 : Based upon a load factor of 1.6 for hot dipped galvanised unrestrained condition as specified in BS EN 1993-1-3 : 2006
- 2 : Slip limits loading capacity
- 3 : Load limit is 50%

All dimensions (mm) are nominal

Swiftrack® channel support system

cantilever arms (continued)

■ Dimensions and weights (continued)

Cantilever arm bracket SA 756

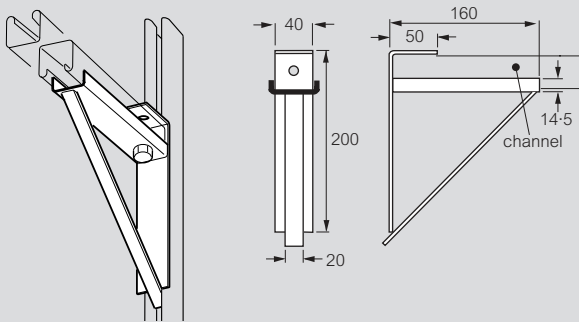

Horizontal arm section from 3 mm steel only
Weight each (kg) : 1.13

Weights

All weights given are in kilograms (kg) based on nominal thickness and standard finish

Loads

Maximum uniformly distributed loads for individual cantilever arms are given with the illustrations in this catalogue. However, should the loading not be uniform then the safe limit can be obtained by calculating the bending moment produced by the intended loads and comparing this with the maximum permissible bending moment for the relevant arm

45 kgf.m for SA750 – SA755 and SA757

52 kgf.m for SA760 – SA766

95 kgf.m for SA770 – SA776

To obtain the bending moment resulting from any point load, multiply the size of the load by its distance from the inner end of the arm (see illustration A)

If several point loads exist then the total bending moment will be the sum of the individual bending moment produced by each point load (see illustration B)

If some part of the total load applied to an arm is uniformly distributed along a section of the arm only, then this part load can be treated as a point load acting at the mid-point of that section of arm to which it is applied (see illustration C)

Illustration A

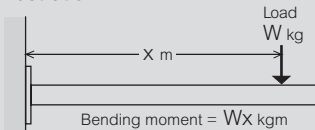

Illustration B

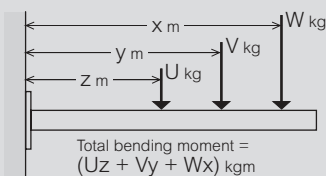
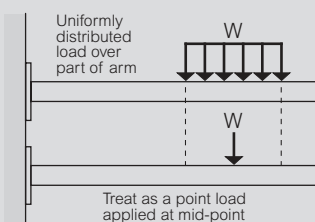

Illustration C



Values assume the tray or other loading medium is rigidly fixed to cantilever arm

Stainless steel cantilever arms

Loads are 60% of those given in the tables, except for those marked 3, in the tables opposite, where the limit is 50%

■ Finishes and standards

The standard finish for all cantilever arms is hot dip galvanised steel to BS EN ISO 1461

Stainless steel to BS EN 10088 : Grade 1.4404 (equivalent to S316L31) is also available as an alternative where applicable

■ Assembly

Fasteners (not included)

Cantilever arms to Swiftrack channel

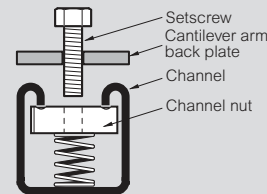

Standard fasteners for Swiftrack are high tensile hexagon head setscrews to BS 3692-8.8, these being zinc plated to BS 3382: Part 2. Most standard Swiftrack brackets are made from 5 or 6 mm gauge steel. Standard cantilever arm backplates are made from 8 mm gauge steel. The use of too long a fastener will prevent proper tightening because the bolt end will foul the bottom of the channel before the head tightens down on the fitting.

When fastening brackets other than Swiftrack, longer bolts may be required if the bracket thickness is greater than 8 mm

Channel type	Backplate thickness	Recommended fasteners
Deep channel SC400 series	6-8 mm 5-6 mm	M10 or M12 x 35 M10 or M12 x 25
Shallow channel SC200 series	7-8 mm 5-6 mm	M10 or M12 x 25 M10 or M12 x 20

Swiftrack® channel support system

framework brackets

All framework brackets are manufactured to BS 6946 from steel which complies with BS EN 10025 Grade S275JRC and are supplied singly. Channel nuts and setscrews are not supplied with brackets, therefore must be ordered separately

■ Dimensions and weights

Made from 5 or 6 mm thick steel unless otherwise stated
 Brackets are 40 mm wide and have 14 mm diameter holes to accept M12 (or smaller) setscrews
 All bend radii are 5 mm unless otherwise stated

Weights

All weights given are in kilograms (kg) based on nominal thickness and are for hot dip galvanised finish. For weights in stainless steel finish contact us on +44 (0) 345 605 4333

Loads

All loads are for hot dip galvanised brackets fixed with M12 setscrews and M12 zinc plated channel nuts. Loads for stainless steel brackets are available on request - contact us on +44 (0) 345 605 4333

Minimum Yield Stress of material is 275 N/mm²

Only M10 or M12 channel nuts and bolts should be used for the attachment of load-bearing brackets

In most cases the mode of failure will be slippage of the bracket along the channel. However there are few channel/bracket combinations where the maximum load is dependant upon the strength of the bracket itself

■ Finishes and standards

The standard finish for all framework brackets and beam clamps is hot dip galvanised steel to BS EN ISO 1461

Stainless steel to BS EN 10088 : Grade 1.4404 (equivalent to S316L31) is also available as an alternative where applicable. To order stainless steel finish add **S** to the end of the standard catalogue number

For example : SB500**S**

■ Assembly

Fasteners (not included)

Fixing brackets to Swiftrack channel

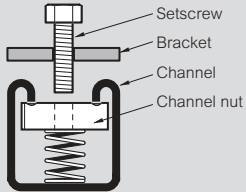

Standard fasteners for Swiftrack are high tensile hexagon head setscrews to BS 3692-8.8, these being zinc plated to BS 3382 : Part 2. The use of too long a fastener will prevent proper tightening because the bolt end will foul the bottom of the channel before the head tightens down on the fitting

When fastening brackets other than Swiftrack, longer bolts may be required if the bracket thickness is greater than 8 mm

For channel nuts, **p. 107**

Channel type	Backplate thickness	Recommended fasteners ¹
Deep channel SC400 series	6 mm and 8 mm	M10 or M12 x 35 mm ²
	5 mm and 6 mm	M10 or M12 x 20 mm
Shallow channel SC200 series	7 mm and 8 mm	M10 or M12 x 25 mm ²
	5 mm and 6 mm	M10 or M12 x 20 mm

1 : The use of too long a fastener will prevent proper tightening because the bolt end will foul the bottom of the channel before the head tightens down on the fitting

2 : When fastening brackets other than Swiftrack, longer bolts may be required if the bracket thickness is greater than 8 mm

■ 90° brackets

SB500

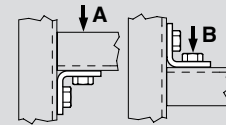
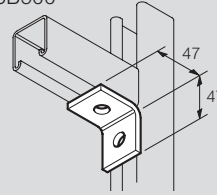

Maximum load on each bracket with both ends supported : A = 350kgf. B = 174kgf
 Unit weight (kg) : 0.125

SB501

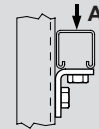
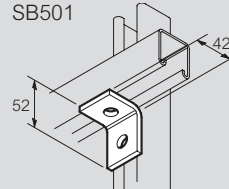

Maximum load on each bracket :
 A = 180kgf
 Unit weight (kg) : 0.125

SB502

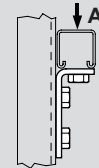
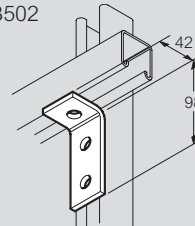

Maximum load on each bracket :
 A = 230kgf
 Unit weight (kg) : 0.191

SB503

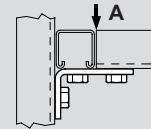
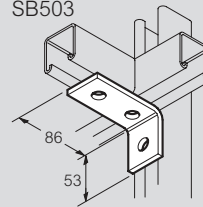

Maximum load on each bracket with both ends supported : A = 120kgf
 Unit weight (kg) : 0.191

SB504

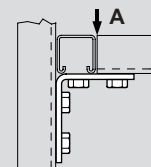
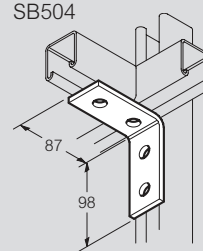

Maximum load on each bracket :
 A = 120kgf
 Unit weight (kg) : 0.257

SB505

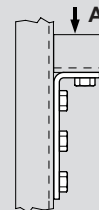
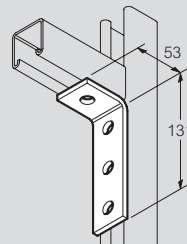

Maximum load on each bracket :
 A = 300kgf
 Unit weight (kg) : 0.257

All dimensions (mm) are nominal

Swiftrack® channel support system

framework brackets (continued)

■ 90° brackets (continued)

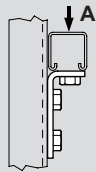
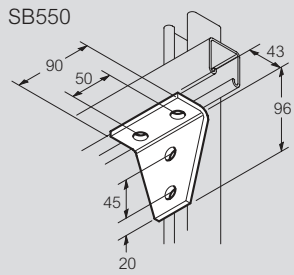

Maximum load on each bracket :
A = 600kgf
Unit weight (kg) : 0-359

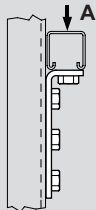
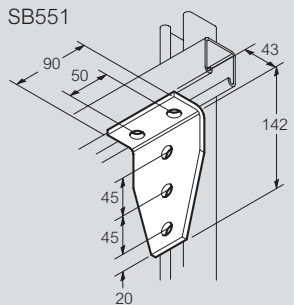

Maximum load on each bracket :
A = 600kgf
Unit weight (kg) : 0-516

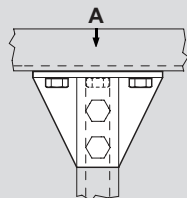
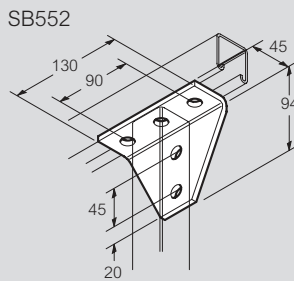

Maximum load on each bracket :
A = 700kgf. 5mm thick.
Unit weight (kg) : 0-488

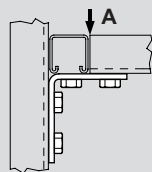
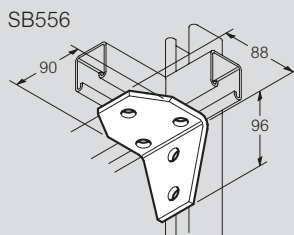

Maximum load on each bracket with
both ends supported : A = 260kgf
Unit weight (kg) : 0-478

■ Square plates and splice plates

Square plates

Cat. Nos.	Fasteners	Unit weight (kg)
SB50606	M6	0-063
SB50608	M8	0-062
SB50610	M10	0-061
SB50612	M12	0-058

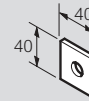

Use as location plate when attaching any special fitment which will not sit across both channel sides

Splice plates

Holes spaced at 45 mm centres

SB507

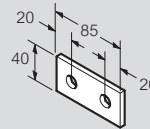

Unit weight (kg) : 0-125

SB508

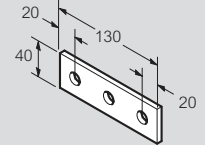

Unit weight (kg) : 0-191

SB509

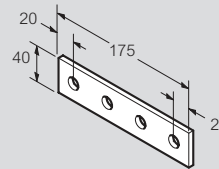

Unit weight (kg) : 0-257

SB510

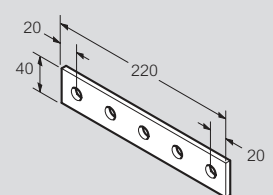

Unit weight (kg) : 0-323

■ U and Z brackets

U bracket

SB514

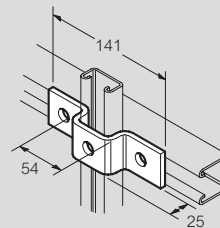

Unit weight (kg) : 0-243

SB515

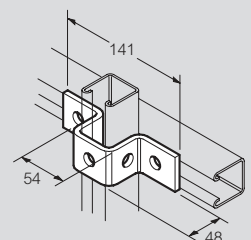

Hole on one side of bracket only
Unit weight (kg) : 0-307

Z bracket

SB511

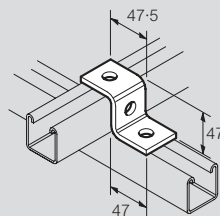

Unit weight (kg) : 0-179

SB513

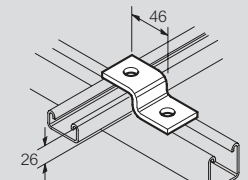

Unit weight (kg) : 0-150

All dimensions (mm) are nominal

Swiftrack® channel support system

framework brackets (continued)

■ Angle brackets

Obtuse angle brackets

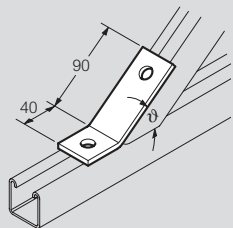

Cat. Nos.	Angle ϑ	Unit weight (kg)
SB520	15	0.197
SB524	45	0.197
SB526	60	0.197
SB528	75	0.197

Acute angle brackets

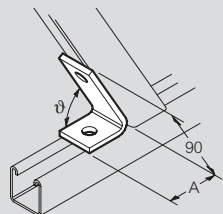

Cat. Nos.	Angle ϑ	A (mm)	Unit weight (kg)
SB532	45	65	0.237
SB534	60	46	0.197
SB536	75	46	0.197

■ T plates and brackets

T plate

SB554

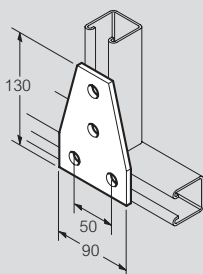

Unit weight (kg) : 0.359

SB555

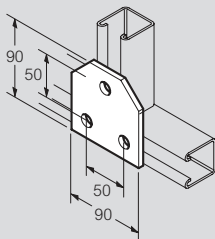

Unit weight (kg) : 0.284

T plate

SB603

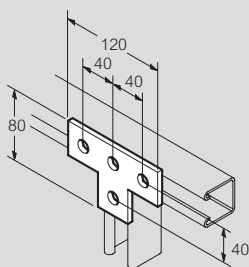

Unit weight (kg) : 0.233

90° T bracket

SB606

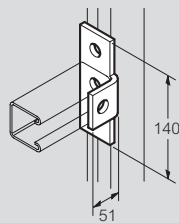

Unit weight (kg) : 0.32
Not available in S finish

Cross plate

SB603+

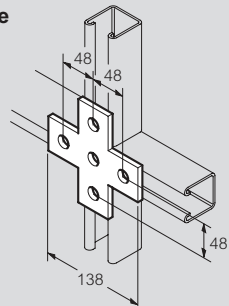

Unit weight (kg) : 0.35
Not available in S finish

45° T bracket

SB607

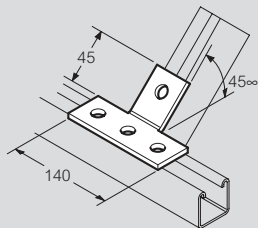

Unit weight (kg) : 0.32
Not available in S finish

■ Joining brackets and channels

Joining bracket

SB518

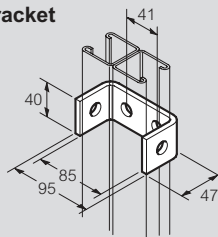

Unit weight (kg) : 0.249

Joining channel

SB651

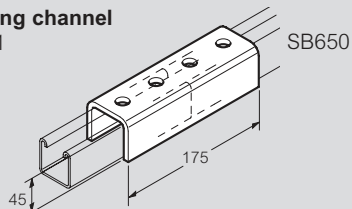

For SC400 channel. 45 mm deep
Unit weight (kg) : 0.85

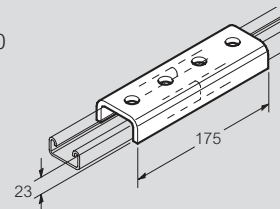

For SC200 channel. 23 mm deep
Unit weight (kg) : 0.55

■ L brackets

L bracket

SB600

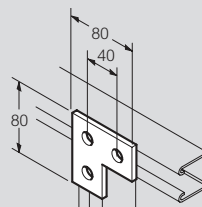

Unit weight (kg) : 0.163

Left hand

L corner bracket

SB602

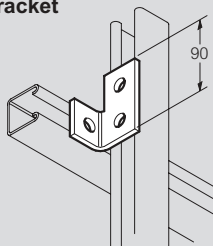

Unit weight (kg) : 0.27
Not available in S finish

Right hand

L corner bracket

SB601

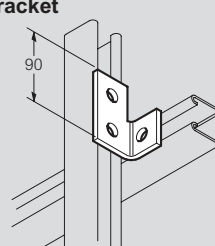

Unit weight (kg) : 0.27
Not available in S finish

All dimensions (mm) are nominal

Swiftrack® channel support system

framework brackets (continued) and beam clamps

Wing brackets and shelf brackets

2 lug wing bracket
SB700

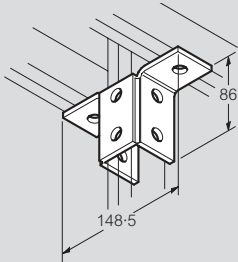

Unit weight (kg) : 0.492

3 lug wing bracket
SB701

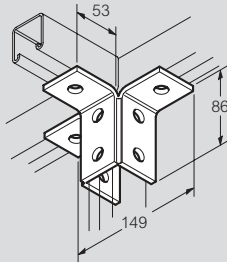

Unit weight (kg) : 0.581

Angled wing bracket
SB707

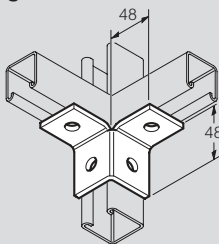

Unit weight (kg) : 0.250
Not available in S finish

Shelf bracket
SB703

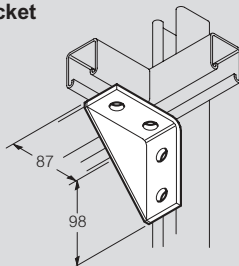

Gusset only, 3 mm thick
Unit weight (kg) : 0.369

Base plates and gusseted brackets

Single channel base plate
SB704

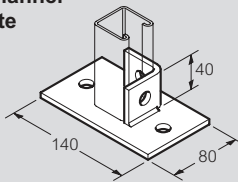

Distance between hole centres : 100 mm
Unit weight (kg) : 0.618

Double channel base plate
SB705

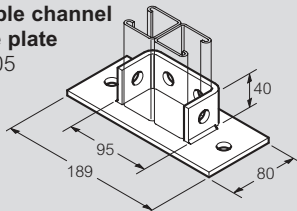

Distance between hole centres : 149 mm
Unit weight (kg) : 0.848

Single channel gusseted bracket
SB702

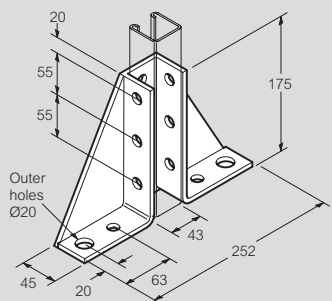

Unit weight (kg) : 1.848

Double channel gusseted bracket
SB706

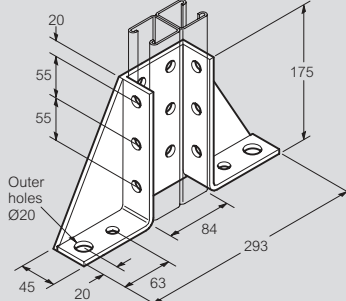

Unit weight (kg) : 2.118

Beam clamps

Beam clamps are supplied singly
Nut, bolts, cone point screws and U bolts where shown are included
Beam clamps conform to BS 6946

Dimensions and weights

All weights given are in kilograms (kg) based on nominal thickness and are for hot dip galvanised finish unless otherwise stated. For weights in stainless steel finish contact us on +44 (0) 345 605 4333

Beam clamp
SC850

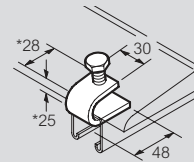

6 mm
Maximum load : 400kgf/pair
Use in pairs
Not available in S finish
Unit weight (kg) : 0.117

Beam clamp
SC851

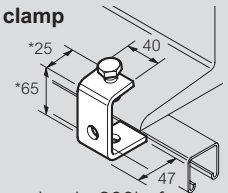

6 mm
Maximum load : 200kgf
Unit weight (kg) : 0.208

Window beam clamp
SC852/21

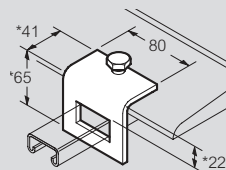

6 mm
For 21 mm channel
Maximum load : 475kgf/pair
Use in pairs
Unit weight (kg) : 0.37

Window beam clamp
SC852/41

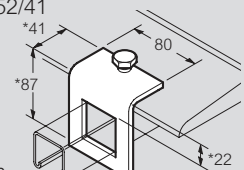

6 mm
For 41 mm channel and 21 mm back-to-back channels
Maximum load : 475kgf/pair
Use in pairs
Unit weight (kg) : 0.52

Window beam clamp
SC852/82

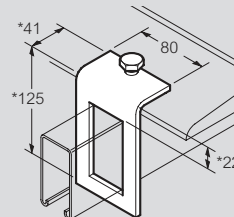

6 mm
For 41 mm back-to-back channels.
Maximum load : 375kgf/pair
Use in pairs
Not available in S finish
Unit weight (kg) : 0.56

Beam clamp
SC853

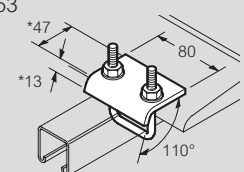

Maximum load : 900kgf/pair
Use in pairs
Unit weight (kg) : 0.30

Beam Clamp
SC854

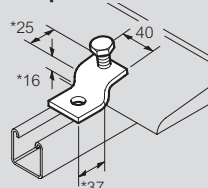

6 mm
Maximum load : 350kgf/pair
Use in pairs
Unit weight (kg) : 0.17

(*) Inside dimensions (mm)

All dimensions (mm) are nominal

Swiftrack® channel support system

beam clamps and pipe clamps

■ Beam clamps (continued)

Beam clamp

SC855

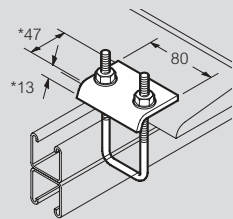

Maximum load : 900kgf/pair
Use in pairs
Unit weight (kg) : 0.308

Toe beam clamp

SC856

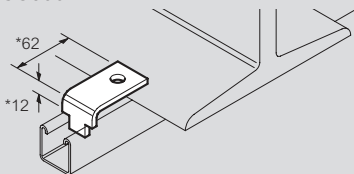

6 mm
Maximum load : 400kgf/pair
Use in pairs
Requires 2 setscrews and channel nuts for fixing (not included)
Unit weight (kg) : 0.179

Beam Clamp

ZC1

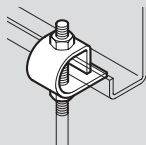

Maximum load : 25kg
Use M10 Rod
Zinc plated to BS 3382: Part 2
Unit weight (kg) : 0.10

Beam Clamp

FL2

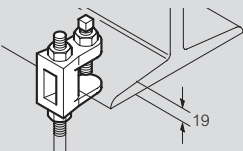

Maximum load : 240kg
Use M10 Rod
Zinc plated to BS 3382 : Part 2
Not available in S finish
Unit weight (kg) : 0.15

■ Pipe clamps

Supplied singly
Nuts and bolts where shown are included
Pipe clamps conform to BS 6946

Dimensions and weights

All weights given are in kilograms (kg) based on nominal thickness and are for hot dip galvanised finish unless otherwise stated. For weights in stainless steel finish contact us on +44 (0) 345 605 4333

SP960 - SP973

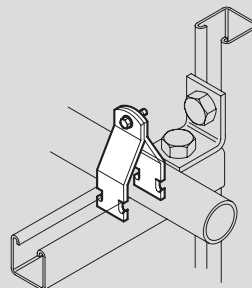

Cat. Nos.	Pipe diameter (mm)	Unit weight (kg)
SP960	10-14	0.06
SP964	17-22	0.08
SP965	22-26	0.09
SP968	25-36	0.10
SP969	32-42	0.11
SP972	42-59	0.13
SP973	54-65	0.15

SP975 - SP976

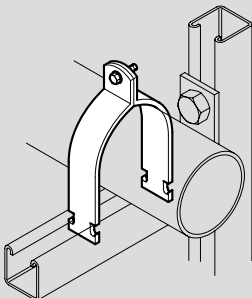

Cat. Nos.	Pipe diameter (mm)	Unit weight (kg)
SP975	62-71	0.16
SP976	73-83	0.17

■ Finishes and standards

The standard finish for pipe clamps is pre-galvanised steel to BS EN 10327 – grade DX51D and Z275 finish
Stainless steel to BS EN 10088 : Grade 1.4404 (equivalent to S316L31) is also available as an alternative

All dimensions (mm) are nominal

Swiftrack® channel support system

channel accessories

■ Channel accessories

Channel accessories conform to BS 6946

Dimensions and weights

All weights given are in kilograms (kg) based on nominal thickness and are for hot dip galvanised finish unless otherwise stated. For weights in stainless steel finish contact us on +44 (0) 345 605 4333

Channel end caps	
Cat. Nos.	Finish
SC950B	black
SC950W	white

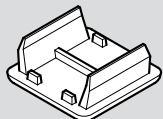

For SC400, SC401 and SC403 channels
Supplied in packs of 100
Weight per 100 (kg): 0.9

Channel end caps	
Cat. Nos.	Finish
SC951B	black
SC951W	white

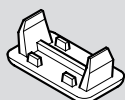

For SC200, SC201 and SC203 channels
Supplied in packs of 100
Weight per 100 (kg) : 0.9

Closure strips	
Cat. Nos.	Finish
SC952	plastic
SC953	metal

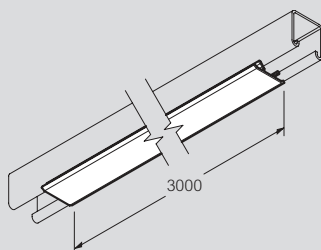

Standard length 3 metres
Unit weight (kg) : SC952 : 0.4
SC953 : 1.0

All dimensions (mm) are nominal



design note



DESIGN NOTES

SELECTING THE RIGHT FINISH

Preventing corrosion	
- Chemical corrosion	118
- Electrochemical corrosion	118
- Galvanic Series	119
- The merits of Zinc	120-121
- Common corrosion situations	122
Suitability of finishes	
- Metallic finishes	122-123
- Organic finishes	122-123

FINISHES

British standards	124
Hot dip galvanised (G)	125
Deep galvanised (D)	125
Pre-galvanised (PG)	126
Stainless steel (S)	126
Powder coated (E)	127

INSTALLATION OF SERVICES

Cable tray systems	
- Design factors to consider	128-133
- Recommended support locations	131-132
- Loading graphs	134-135

STRUCTURAL SUPPORT CHARACTERISTICS

Structural characteristics	
- Cable tray	136
- Beams	136-137
- Columns	137
- Deflection	137

Designing support systems	
- Ceiling to floor applications	138
- Ceiling mounted applications	139
- Wall mounted applications	139
- Floor mounted applications	139

Swiftrack channel support	
- Channels	140
- Channel nuts	140
- Framework brackets	140
- Fasteners	140
- Cantilever arms	141
- Maximum safe recommended loadings	141
- Channels used as beams	142
- Channels used as columns	142
- Fully restrained and unrestrained loads	142
- Beam loads	143

PACKAGING, HANDLING, STORAGE AND SAFETY

Export packaging	144
Handling and storage	145
Safety during installation phase	145

RELEVANT BRITISH, EUROPEAN AND INTERNATIONAL STANDARDS	146-147
--	---------

Selecting the right finish

Preventing corrosion

In planning any cabling or support installation the choice of an appropriate corrosion resistant finish is always a key issue at the specification stage, ranking alongside installation time and load carrying ability. However, unlike these other factors, which are only of importance during the installation phase, the correct choice of finish has long term implications and is crucial for ensuring the longevity (and aesthetics) of the complete installation in order to meet with the client's expectations.

Since future maintenance of any support system is virtually impossible, it is vital that the finish specified for the equipment is capable of providing lifetime protection from corrosion within the intended environment - ideally with some margin of safety.

The following pages give information on how corrosion occurs and supporting technical data on the standard construction materials and surface finishes available within each range of products supplied by Legrand. Contact our technical team on +44 (0) 345 605 4333 for further information.

Corrosion occurs on all metals to some extent. With some, such as stainless steel, its effects are usually only slight but even then the presence of certain chemicals or physical contact with other metals may cause rapid corrosion. It is therefore important to consider every aspect of the environment surrounding any intended installation in order to choose a material or finish which will minimise the risk of damage to the support system through the effects of corrosion.

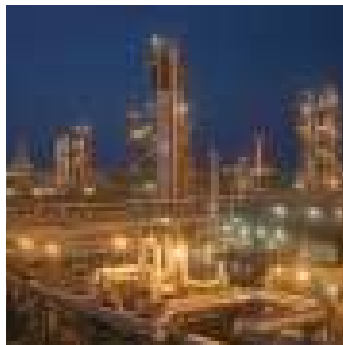

IN THIS SECTION...

Preventing corrosion

1. Chemical corrosion
2. Electrochemical corrosion
3. Galvanic Series
4. The merits of Zinc
5. Common corrosion situations

Suitability of finishes

1. Metallic finishes
2. Organic finishes

1 Chemical corrosion

Few metals will suffer corrosion damage in a dry, unpolluted atmosphere at a normal ambient temperature. Unfortunately such environments are exceptional and atmospheric pollutants are likely to be present to some degree in most situations where support systems will be installed. Thus mild chemical corrosion is normal in almost all situations and useful information on the types of material or choices of finish which will inhibit and control this are given within the following pages.

Any support installation which will be situated in an area where higher concentrations of chemicals exist must receive more detailed consideration in order to select a finish which provides the best combination of initial cost and expected life. To assist in this, tables on page 123, give guidance on the suitability of the standard materials and finishes used for support systems in the presence of those chemicals most commonly found within industry. More detailed information is available upon request, please contact us on +44 (0) 345 605 4333.

2 Electrochemical corrosion

When two dissimilar metals are in contact and become damp it is possible for corrosion to be induced in one of the metals. Such corrosion may progress rapidly and cause considerable damage so it is important to consider and, if necessary, take steps to eliminate this process occurring.

Electrochemical (or electrolytic) corrosion takes place because the two different metals each behave as electrodes and the moisture as the electrolyte in a simple battery; as with any battery the resulting flow of current will cause corrosion of the anode. The likely effects of this reaction can be predicted using the Galvanic Series.

3 Galvanic Series

Even when two dissimilar metals are in moist contact, electrochemical corrosion need not necessarily take place. Its likelihood depends upon the potential difference between the two metals; this can be obtained by taking their respective values from the chart below and subtracting one from the other.

When the potential difference is less than the values given in the table to the right corrosion is unlikely to occur.

Environment	Maximum Potential Difference
Marine and outdoor	0.3 volts
Indoor	0.5 volts
Indoor, hermetically sealed (dry)	No restriction ⁽¹⁾

(1) With no moisture to act as the electrolyte no electrochemical corrosion can take place

If corrosion does take place the metal which is higher in the Series (to the right) will be corroded in preference to that which is lower in the Series (to the left).

Galvanic Series chart

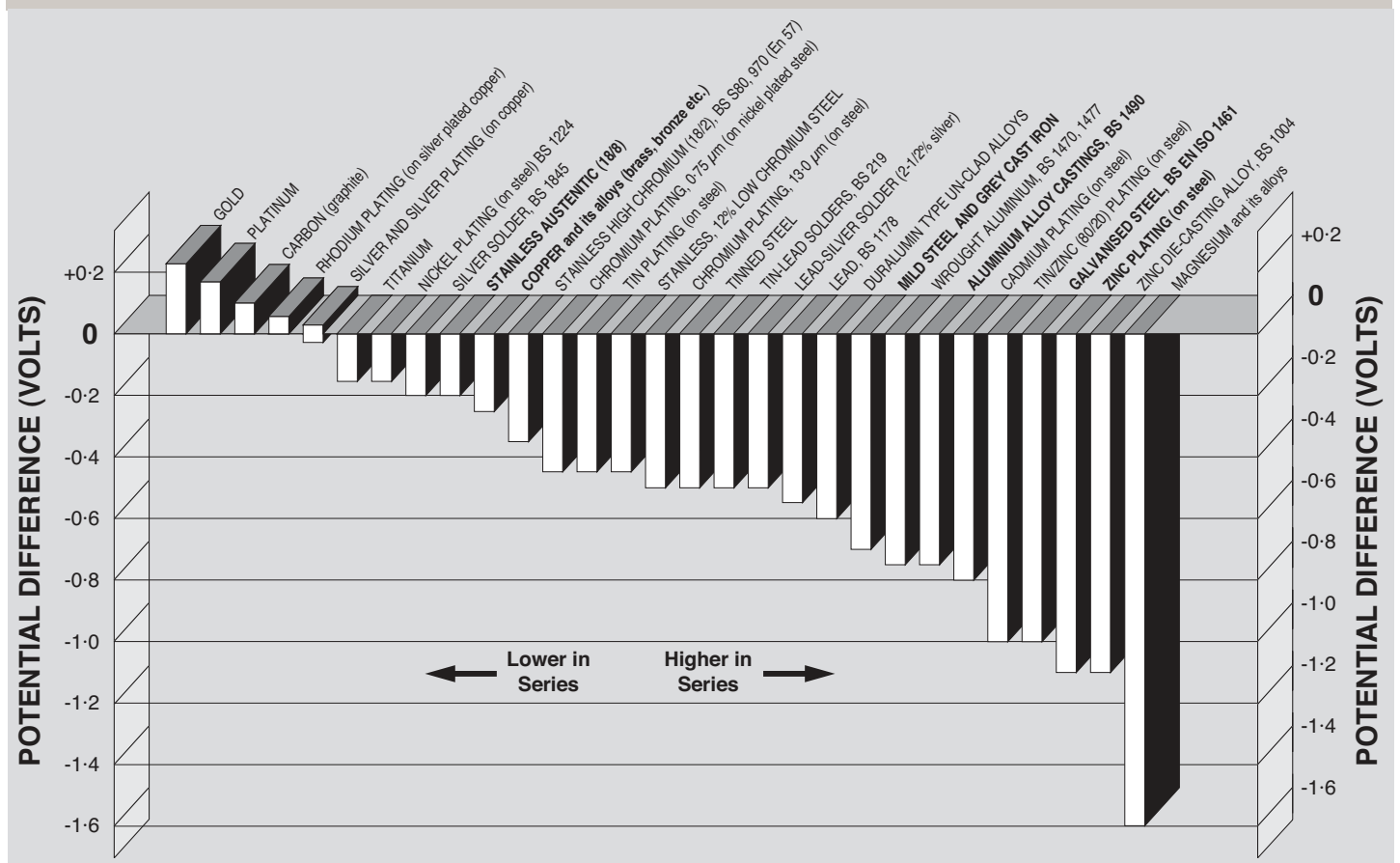

The Galvanic Series illustrates the potential difference between a section of metal and a Calomel electrode when both are immersed in sea water at 25°C. This chart contains most commonly used engineering or plating metals.

If corrosion does take place the metal which is higher in the series (to the right) will be corroded in preference to that which is lower in the series (to the left).

If the affected metal has a small surface area in relation to its counterpart it will be corroded very aggressively and any sacrificial protection it provides may be short-lived. If on the other hand it has a large surface area in comparison to its less reactive counterpart, some minor corrosion may take place at points of contact but the process is likely to reach equilibrium rapidly so that any further reaction is insignificant.

If from consideration of this Series excessive corrosion does appear likely then the risk can be largely eliminated by insulating the dissimilar metals from one another, breaking the electrical path between them. A layer of paint on either surface is usually sufficient to achieve this.

4 The merits of Zinc

The Galvanic Series does show why zinc is such a useful corrosion resistant coating for mild steel.

Firstly, it forms an impervious zinc barrier around the steel, coating it with a metal whose own rate of chemical corrosion is both low and predictable in most situations.

Secondly, if the coating is damaged at any point (e.g. at a cut edge) the zinc surrounding the damaged area becomes the anode of the electrolytic cell and is sacrificially corroded away very slowly in preference to the underlying steel. This ensures the strength of the steel structure remains unaffected.

Because zinc appears near the top of the Galvanic Series it will act as a sacrificial anode in relation to most other metals; thus its relatively low cost and the ease with which it can be applied as a galvanised coating on steel means that it continues to be the most commonly specified protective finish for support systems.

Life expectancy of zinc coatings

The resistance of galvanising to atmospheric corrosion depends on a protective film which forms on the surface of the zinc. When the steel is withdrawn from the galvanising bath the zinc has a clean, bright, shiny surface. Over time the appearance will change to a dull grey patina as the surface reacts with oxygen, water and carbon dioxide in the atmosphere. A complex but tough, stable and protective layer is formed which adheres to the zinc. Contaminants in the atmosphere affect the nature of this protective film.

The most significant contaminant which will accelerate the corrosion rate of zinc is sulphur dioxide (SO₂) and it is the presence of SO₂ which largely controls the atmospheric corrosion of zinc.

The Galvanizers Association has undertaken significant research based on the positioning of reference canisters placed throughout the UK and the Republic of Ireland to establish background corrosion rates for 10 km square grids which has resulted in the formation of The Zinc Millennium Map.

For most sites on this map an average hot dip galvanised coating will last between 40 to 100 years, highlighting the potential for significant financial savings when galvanising is specified. However, with the correct use of the map specific locations can be analysed for average zinc corrosion rates per year.

The Zinc Millennium Map

The definitive geographical guide to the different corrosion levels of galvanised steel products used in the construction industry.

Corrosion rate key	1	2	3	4	5
Average Corrosion rate (µm/year)	0.5	1	1.5	2	2.5
Average life of 85µm galvanised coating (years)	187	85	57	43	34

Please note this is an average background corrosion rate for zinc. For further information please contact the Galvanizers Association.

BS EN ISO 14713 general corrosion effects and life expectancy for zinc coated products

Corrosivity category	Corrosion rate of	Environment - interior	Environment - exterior	Pollution level	Zinc coating thickness	Coating life years									
						10	20	30	40	50	60	70	80	90	100
C1	< 0.1 Very low	Warm, dry, no pollution		0	PG (Z275) = 19 microns										
					G = 55 microns										
					D = 110 microns										
C2	0.1 to 0.7 Low	Unheated, low condensation, low pollution	Temperate, rural, urban with low pollution	<5	PG (Z275) = 19 microns										
					G = 55 microns										
					D = 110 microns										
C3	0.7 to 2 Medium	Moderate condensation & pollution eg food processing plants	Temperate, urban with medium pollution, mild coastal	5 to 30	PG (Z275) = 19 microns										
					G = 55 microns										
					D = 110 microns										
C4	2 to 4 High	High condensation, high pollution eg chemical or industrial plants,	Temperate, urban with high pollution, industrial, coastal	30 to 90	PG (Z275) = 19 microns										
					G = 55 microns										
					D = 110 microns										
C5	4 to 8 Very high	Very high condensation & industrial pollution, eg mines	Temperate, very high pollution, industrial & high salinity coastal	90 to 250	PG (Z275) = 19 microns										
					G = 55 microns										
					D = 110 microns										
CX	8 to 25 Extreme	Permanent condensation & high pollution	Very high pollution, extreme industrial, coastal & offshore with occasional salt	>250	PG (Z275) = 19 microns										
					G = 55 microns										
					D = 110 microns										

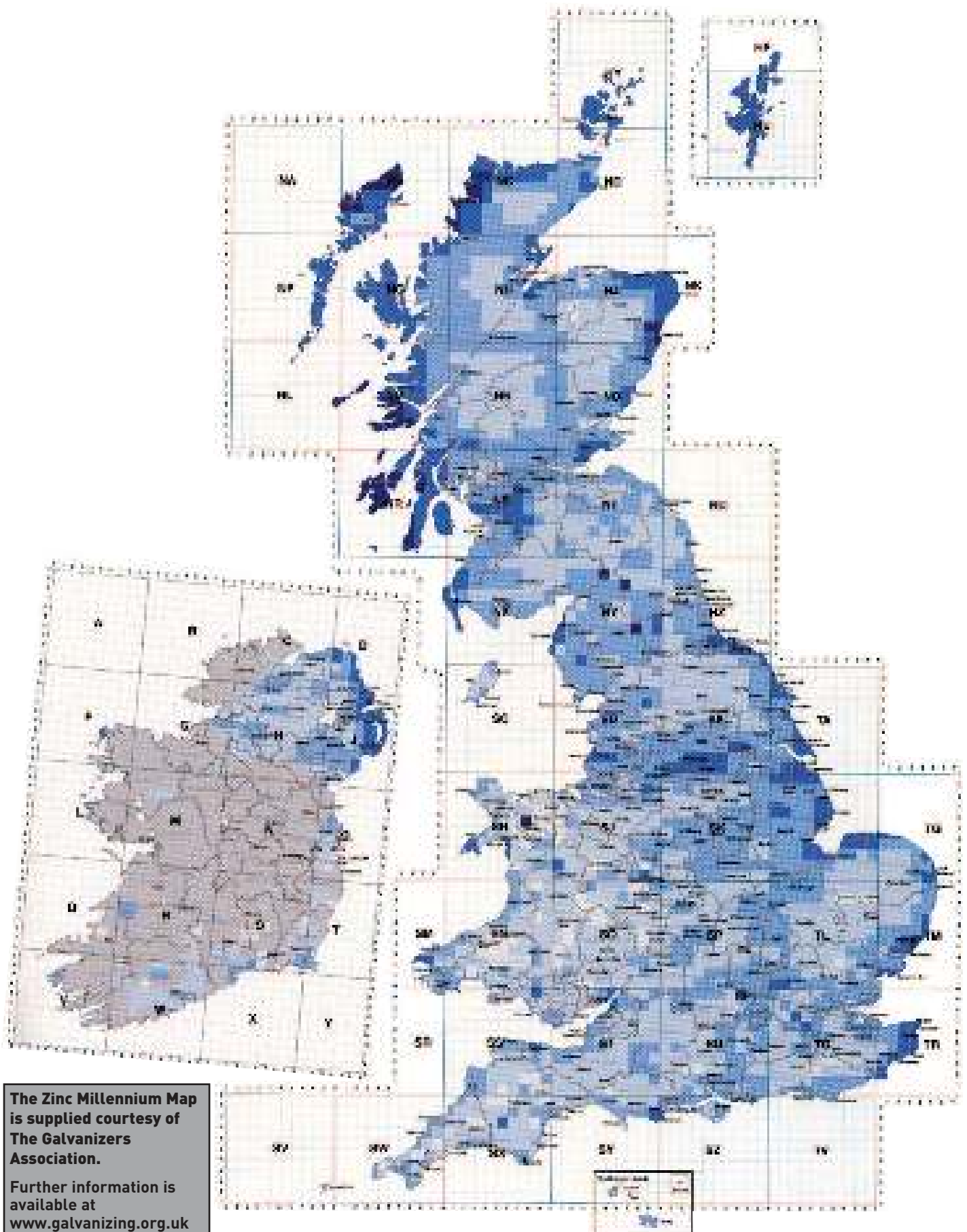

The Zinc Millennium Map is supplied courtesy of The Galvanizers Association.

Further information is available at www.galvanizing.org.uk

5 Common corrosion situations

Finally, the most common occurrences of contact between dissimilar metals within support systems are :

- a. Where stainless steel components are being fixed to a carbon steel structure
 - b. Where galvanised or zinc plated components are being fixed onto a stainless steel support system
 - c. Where copper components (e.g. copper tubing or MICC cable) are being installed onto a galvanised steel support system
- In relation to these three sets of conditions the following comments apply :

(i) Stainless steel – mild steel

This situation has been the subject of much consideration and debate over recent years, particularly in the offshore energy industry.

Whilst Legrand can supply kits of components (including, according to the circumstances, insulating pads, sleeves for fasteners or insulating coatings) the latest metallurgical advice from both the manufacturers of stainless steel and other bodies is that these metals are sufficiently close together in the Galvanic Series for any electrolytic effects to be ignored in normal offshore environments. One exception is when a small mild steel (or galvanised mild steel) component is in direct contact with a large mass of stainless steel.

It is now accepted that the application of a simple paint coating to one of the juxtaposed surfaces will provide sufficient insulation to break the electrical circuit, effectively eliminating any problems.

(ii) Small galvanised components on stainless steel

The zinc coating will provide very limited protection to its underlying steel because of the rapidity with which it will erode away. Once exposed the base steel (often a fastener) will be aggressively corroded causing unsightly staining of the stainless steel and premature failure to the component. In the case of fasteners such failure could be catastrophic to the installation so appropriate stainless steel fasteners should always be used with a stainless steel support system.

(iii) Copper on zinc

If copper is laid directly onto a galvanised surface the zinc will rapidly erode. Thus MICC cable should always have an insulating sheath if it is to be installed on galvanised cable tray.

Suitability of finishes

1 Metallic finishes

The table on the following page outlines the suitability of metallic finishes under a variety of conditions. The following notes apply to the data :

1. Hard water promotes the formation of a stable protective film on a hot dip galvanised coating.
2. Salt spray testing should not be used on galvanised coatings; the data provided by such accelerated weathering tests is misleading and inaccurate on this finish since the formation of the protective film (patina) is prevented from forming under the artificial conditions.
3. No information is available on the resistance of galvanised coatings to contact with this type of oil. However, in general terms galvanised coatings are resistant to oil-based products.
4. Resistant provided that the oil is stable, free from acidity and of mineral origin.
5. Under immersed conditions contact with this chemical is not recommended and over-coating with a paint or powder system is necessary. When this chemical is an airborne aerosol the coating performance depends on various factors specific to the particular application. Corrosion rates will be high and if condensation is likely to be heavy and its pH value is outside the range pH5 - pH12.5 then overpainting or coating of the galvanising is normally recommended.

If the galvanised surface is frequently washed by fresh water and allowed to periodically dry out then the level of corrosion will be less severe.

2 Organic finishes

Refer to the table on the following page for information on the suitability of organic finishes under a variety of conditions.

Suitability of metallic finishes

		Stainless steel 316	Stainless steel 304	Pre-galvanised steel	Hot dip galvanised steel	Deep galvanised steel	Aluminium
ENVIRONMENTS	Fresh water	✓	✓	×	✓ see note (1)	✓ see note (1)	
	Salt spray B177 Test	✓	✓	×	✓ see note (2)	✓ see note (2)	✓
	Polluted marine environment	✓	×	×	✓	✓	0
SOLVENTS	Acetone	✓	✓		✓	✓	✓
	Petroleum (gasoline)	✓	✓		✓	✓	✓
	Trichloroethylene	✓	✓		✓	✓	
	Glycerine	✓	✓		✓	✓	
	Methyl chloride	✓	✓		✓	✓	0
OILS	Linseed oil	✓	✓	0 see note (3)	0 see note (3)	0 see note (3)	
	Penetrating oil	✓	✓	0 see note (3)	0 see note (3)	0 see note (3)	
	Lubricating oil	✓	✓	0 see note (5)	0 see note (4)	0 see note (4)	
ACIDS	10% Sulphuric acid	×	×	0 see note (5)	0 see note (5)	0 see note (5)	×
	Conc. Sulphuric acid	✓ X at high temp.	✓ X at high temp.	0 see note (5)	0 see note (5)	0 see note (5)	✓ X above 40°C.
	10% Hydrochloric acid	×	×	0 see note (5)	0 see note (5)	0 see note (5)	×
	10% Nitric acid	✓	✓	0 see note (5)	0 see note (5)	0 see note (5)	✓
	50% Phosphoric acid	✓	×	0 see note (5)	0 see note (5)	0 see note (5)	×
	10% Acetic acid	✓	✓	0 see note (5)	0 see note (5)	0 see note (5)	
	5% Tartaric acid	✓	0	0 see note (5)	0 see note (5)	0 see note (5)	×
	5% Citric acid	✓	✓ X at high temp.	0 see note (5)	0 see note (5)	0 see note (5)	×
10% Lactic acid	✓	×	0 see note (5)	0 see note (5)	0 see note (5)		
ALKALINES	10% Caustic soda sodium hydroxide	✓	×	0 see note (5)	0 see note (5)	0 see note (5)	
	25% Caustic soda	✓	×	0 see note (5)	0 see note (5)	0 see note (5)	×
	10% Ammonia	0	0	0 see note (5)	0 see note (5)	0 see note (5)	

KEY : ✓ Probably suitable ● × Probably unsuitable ● 0 Investigate if no alternative

For notes (1) to (5) see left hand page

Suitability of organic finishes

		Epoxy powder	Polyester epoxy mix coating	PVC coating	GRP polyester	GRP vinyl ester	PVC
ENVIRONMENTS	Fresh water	✓	✓	✓	✓	✓	✓
	Salt spray B177 Test	✓	✓ 500 hours	✓ 500 hours	0	0	✓
	Polluted marine environment	×	×	×	×	✓	×
SOLVENTS	Acetone	×	✓	×	×	×	×
	Petroleum (gasoline)	✓	✓	✓ X above 75°C.	✓ X above 60°C.	✓	✓ X above 75°C.
	Trichloroethylene	×	✓	×	×	×	×
	Glycerine	✓	✓	✓ X above 75°C.	✓	✓	✓ X above 75°C.
	Methyl chloride	×	✓	×	×	×	×
OILS	Linseed oil	✓	✓	✓ X above 75°C.	✓	✓	✓ X above 75°C.
	Penetrating oil	✓	✓	✓ X above 75°C.	✓	✓	✓ X above 75°C.
	Lubricating oil	✓	✓		✓ X above 60°C.	✓	
ACIDS	10% Sulphuric acid	✓	✓	✓ X above 75°C.	✓	✓	✓ X above 75°C.
	Conc. Sulphuric acid	×	×	×	×	✓	×
	10% Hydrochloric acid	✓	✓	✓ X above 30°C.	✓ X above 60°C.	✓	✓ X above 30°C.
	10% Nitric acid	×	✓ X above 20°C.	✓ X above 30°C.	×	✓ X above 50°C.	
	50% Phosphoric acid	✓	✓	✓ X at high temp.	✓	✓	✓ X above 75°C.
	10% Acetic acid	✓	✓	×	✓	✓	
	5% Tartaric acid	✓	✓	✓ X above 75°C.	✓	✓	
	5% Citric acid	✓	✓	✓	✓	✓	✓ X above 75°C.
10% Lactic acid	✓	✓	✓	✓ X above 60°C.	✓	✓ X above 75°C.	
ALKALINES	10% Caustic soda sodium hydroxide	✓	✓	✓	×	✓	✓ X above 75°C.
	Caustic soda	✓	✓	✓ X above 75°C.	×	×	
	10% Ammonia	✓	✓	✓	×	✓ X above 35°C.	✓ X above 75°C.

KEY : ✓ Probably suitable ● × Probably unsuitable ● 0 Investigate if no alternative

Finishes

IN THIS SECTION...

1. British standards
2. Hot dip galvanised (G)
3. Deep galvanised (D)
4. Pre-galvanised (PG)
5. Stainless steel (S)
6. Powder coated (E)

Available on cable tray and Swiftrack support systems

1 British standards

Legrand ensures that all of the materials used during the construction and finishing of their products conform to the relevant standards, a full list of which is provided on p. 146. In particular, the relevant standards for steel are :

Finish	Product	Current standard/grade
G	Tray less than 1.5mm thick	BS EN 10130 : 2006 Grade DC01
G	Tray 1.5mm and thicker	BS EN 10111 : 1998 Grade 1.0332 / BS EN 10025 : 2004 Grade S275JRC
G	Swiftrack channel	BS EN 10025 : 1993 Grade S235JRC (Ys = 250N/mm ² min)
G	Swiftrack brackets	BS EN 10025 : 2004 Grade S275JRC
D	Tray	High silicon steel to BS EN 10025-5 : 2004 Grade S355JOWP / Corten A*
PG	Tray	BS EN 10346 : 2009 Grade DX51D
PG	Swiftrack channel	BS EN 10346 : 2009 Grade S250GD + Z275
S	Tray and Swiftrack	BS EN 10088 : 2005 Grade 1.4404 (equivalent to S316L31)

Finishes :

G = hot dip galvanised after manufacture
 D = deep galvanised
 PG = pre-galvanised
 S = stainless steel
 E = powder coated

* Depending on availability of raw materials

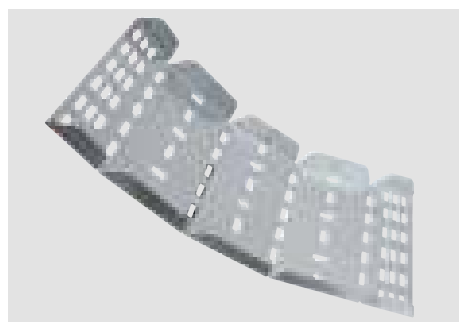

Heavy duty (SRF) inside riser shown in PG finish
See p. 21

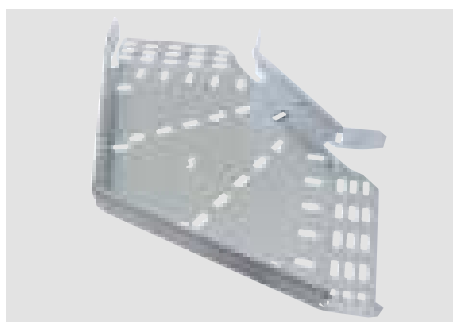

Heavy duty (SRF) bend shown in PG finish
See p. 21

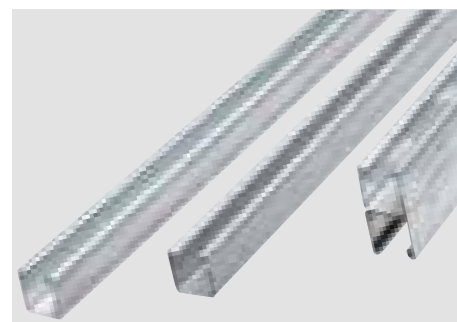

Swiftrack channel support shown in PG finish
See p. 28

2 Hot dip galvanised (G)

Hot dip galvanising after manufacture is an excellent, economical protective finish used on support systems in many industrial and commercial applications.

Background

The galvanised coating is applied as a final manufacturing process by immersing a steel component (after various pre-treatments) in a large bath of molten zinc; the zinc forms an alloy with the steel substrate and protects the steel from corrosion in two ways.

Firstly, the zinc coating surrounds the base steel with a total, tough physical barrier preventing corrosion of the steel by the surrounding atmosphere. Secondly, if steel does become exposed, e.g. at a cut edge, the zinc coating acts as a sacrificial anode and will be gradually corroded in preference to the underlying steel. Corrosion products from the zinc will also be deposited onto the steel, effectively re-sealing the surface and maintaining the integrity of the barrier.

The life of a zinc coating is directly proportional to its thickness but in different environments this life does vary. However because hot dip galvanising has been used for many years its life in diverse environments has been well established. The most comprehensive guide to the design life of protective systems in different environments is contained in BS EN ISO 12944-5 : 2007 'Paints and varnishes' and BS EN ISO 14713 : 2009 'Parts 1 + 2 - zinc coatings'. In the presence of certain atmospheric pollutants (such as sulphur dioxide in industrial areas) or when installed in an aggressive coastal or marine environment the rate of dissipation of the zinc will be accelerated; however in most situations hot dip galvanising remains an extremely effective and economical corrosion resistant finish.

Specification

BS EN ISO 1461 provides the specification for a hot dip galvanised coating. Heavier gauges of steel will usually take up a thicker coating of zinc than lighter gauges so the standard defines the coating for different steel gauges in terms of the weight of zinc per square metre of surface area. Ensuring compliance with this standard is obviously important. Unfortunately it is not reasonable to use this weight principle for checking the coating weight on components which have already been galvanised as it involves calculating the surface area then weighing a component, destructively removing the coating by chemical means and then re-weighing the component. It is therefore usual to measure instead the coating thickness (which can be done non-destructively using magnetic or electronic instruments) at a number of points on the surface of a component. The coating thicknesses given in the standard and their equivalent coating weights are shown in table 1.

Table 1
Galvanising standard BS EN ISO 1461 : 2009
Minimum average zinc thickness

Steel thickness	Minimum average zinc thickness (microns)
Less than 1.5 mm	45
1.5 mm and thicker up to 3 mm	55
3 mm and thicker up to 6 mm	70
6 mm and thicker	85

Note

For threaded and very small components which are spun galvanised, thinner coatings are used as recommended by BS EN ISO 1461.

It is important to distinguish between 'hot dip galvanised after manufacture to BS EN ISO 1461' and less precise descriptions such as 'galvanised', 'mill galvanised' or even the term 'hot dip galvanised', when used without reference to any standard. Mill galvanised steel is frequently used as an alternative finish for many support system components (see 'pre-galvanised steel', page 126), and is available from Legrand, but this material does have a much thinner zinc coating which renders it unsuitable for exposed applications.

Suggested specification text : "All components should be hot dip galvanised after completed manufacture to the requirements of BS EN ISO 1461."

3 Deep galvanised (D)

A deep galvanised finish has all of the characteristics of hot dip galvanising but with a much thicker coating of zinc. This gives 2-3 times the life of the standard hot dip galvanised (BS EN ISO 1461) finish.

Background

The life of a galvanised coating depends very much upon the degree of pollution of the surrounding atmosphere; in an industrial or marine environment corrosion of the zinc may take place at double or treble the rate which would occur in an inland environment. Thus, if heavy atmospheric pollution or aggressive conditions exist in the vicinity of an installation, it is well worth considering the benefits provided by deep galvanising.

Since this finish is produced in the same basic process as normal hot dip galvanising the initial cost premium of the material is relatively low; however the site installation costs will remain unchanged. Therefore, for a relatively modest premium on the overall installed cost the life of the installation can be increased dramatically.

Specification

Although the appropriate British Standard for deep galvanising is BS EN ISO 1461 (the same as for hot dip galvanising after manufacture) the process requires the use of steel containing a slightly higher proportion of silicon; often referred to as high silicon steel. When galvanising normal mild steel the process effectively ceases after a short immersion time in the galvanising bath, giving, depending on the gauge of the steel, the coating thicknesses laid down within BS EN ISO 1461. However with silicon bearing steels the chemistry of the galvanising process changes, resulting in the zinc coating continuing to increase in thickness as long as the steel remains immersed in the zinc.

Coatings up to three times as thick as the minimum requirements of BS EN ISO 1461 are both possible and practical to achieve. However the most cost effective coating thickness is usually twice the thickness required by BS EN ISO 1461.

4 Pre-galvanised (PG)

A zinc coating can be economically applied to steel sheet immediately after its manufacture; the result, pre-galvanised steel (to BS EN 10346) can be an attractive, bright material which is suitable for non-arduous environments.

Background

Pre-galvanised (or mill galvanised) steel is produced by unwinding steel coil and passing it continuously through a bath of molten zinc and then past air jets to remove excess zinc from the surface. The process is closely controlled to produce a thin, even and ripple-free zinc coating with very few imperfections.

Because this pre-galvanised steel coil must then be cut to shape during subsequent manufacture of support equipment, the edges of the finished components will have no zinc coating; this aspect, together with the relatively light zinc coating provided by the process, make pre-galvanised services suitable for indoor, non-corrosive environments (particularly where an aesthetically attractive appearance is important) but unsuitable for humid indoor or outdoor applications.

Specification

For steel for Swiftrack channel, steel grade is BS EN 10346 : 2009 Grade S250GD + Z275

5 Stainless steel (S)

For all practical purposes most stainless steel services supports can be regarded as maintenance free and suffering no corrosion. Inevitably there is a relatively high price to pay for these attractive properties but, in aggressive environments or where the cost or inconvenience of gaining subsequent maintenance access is prohibitive, this initial cost premium may well be justified.

Background

Stainless steel contains a high proportion of chromium (usually at least 17%) and the steel's remarkable immunity to corrosive attack is conferred by the chromium-rich oxide film which occurs naturally on its surface. This invisible film is not only inert and tightly bonded to the surface, it also re-forms quickly if the surface is damaged in any way.

The fire resistance of stainless steel is particularly noteworthy; tests have demonstrated that stainless steel cable supports can be expected to maintain their integrity for considerable periods even when exposed to direct flame temperatures exceeding 1,000°C. This may be an important consideration where the electrical circuits being supported provide for emergency power or control systems.

Stainless steel is also used where hygiene is a major consideration. Its advantages in such applications are again its excellent resistance to the various chemicals and washes which are frequently used for cleaning purposes and the smoothness of surface (depending on the finish specified) which minimises the soiling or contamination that can take place.

Specification

Many grades of stainless steel are available but the one generally used in aggressive marine environments is BS EN 10088 Grade 1-4404 (equivalent to S316L31, BS 1449: Part 2). This grade has improved corrosion resistance (particularly in the presence of chlorides) and high temperature strength. It is much used in the chloride-laden marine conditions which exist on offshore installations and in coastal regions.

For less aggressive environments BS EN 10088 Grade 1-4301 (equivalent to 304, BS 1449: Part 2) is the normal grade. This grade offers good corrosion resistance in internal applications and also has a good aesthetic quality, often used in the dairy and food industries. Final finishes with mechanical brushing or polishing are often used to provide a good looking and robust surface finish.

Pickling and passivation

A stainless steel surface will have excellent corrosion resistance due to the chromium oxide layer on the surface of the product. With some stainless steels however, the surface areas can become subject to corrosion due to the depletion of chromium during welding, or the introduction of iron during a machining process (not applicable to most cable management products). Where a uniform appearance is important after carrying out welding processes, it is often specified that all surfaces should be pickled and passivated to remove the smoke stain from the welding process. Also where extreme corrosion resistance is called for, this process may help to remove crevice corrosion from around the welding area. Experience has shown that this is not normally necessary for the majority of cable management products.

Pickling

The pickling process involves the article being immersed in a blend of acids which dissolve iron and iron oxides which adhere to, or are embedded in, the surface of the stainless steel. These acids cause a removal of the surface layer of between 1 and 3 microns. The article is finally rinsed with water to complete this stage of the process.

Passivation

Passivation of the stainless steel will occur naturally after pickling when the oxygen in the air will react with the surface of the steel to form a passive chromium oxide layer. However it is usual for this passivation process to be speeded up by immersing the article in a nitric acid or other passivating agent.

Pickle and passivation is available as a special order finish, for more information please contact us on +44 (0) 345 605 4333.

Electropolishing

In various industries such as food, pharmaceutical and electronics, there is a requirement for easier cleaning and reduced bacterial growth on the surface of the stainless steel. This increased surface smoothness is achieved by a process called electropolishing.

Electropolishing is, in principle, a reversal of the electroplating process. The article is submerged in a special acid electrolyte and a DC current passed into the article and through the electrolyte. This process removes the high spots from the surface micro roughness leaving a surface which is bright and smooth.

6 Powder coated (E)

Powder coated finishes give excellent protection against scratches as they are normally between 50 - 100% harder than the equivalent wet paint finishes.

They are available in a wide range of colours and can have matt or various gloss finishes. In addition to the aesthetic qualities powder coating are available in various grades to cope with different site conditions. Grades are produced to cope with exterior applications where there can be high levels of ultra violet light or low smoke and fume applications for fire risk areas such as occur in tunnels. Because powder coated finishes are inherently resilient and resistant to chemical or corrosive attack, these finishes are frequently used for protection only where there is no aesthetic requirement.

Background

The process of powder coating is carried out by applying the electrostatically charged powder to the article, and then passing the article into an oven where the powder is baked onto the surface of the article.

The application of the powder, and the associated stoving, can vary with different types of finish so the careful control of the process is required.

Specification

With such a wide variety of types of powder available it is necessary to specify in addition to the colour what the finish is required to do.

The colour can be specified by BS or RAL number, or by exact colour match if a sample of the colour is provided. The required gloss level should also be given.

The usual finish is for aesthetic indoor use, but if other qualities are required they should be clearly indicated at the outset as the powder cost and application cost can vary considerably between different types of powder.

Epoxy coated

Epoxy coatings are based on thermo-setting epoxy resins and give a very hard, durable finish suitable for internal applications. Epoxy coatings are usually quite thin but they have good chemical resistance with excellent adhesion and coating flexibility.

Polyester epoxy mix

Some modern coating developments consist of both polyester and epoxy. These give properties which are very suitable for use with cable support systems. The finish is thick and fairly soft and gives good protection to the cables being installed. The coating has strong adhesive properties and in cases of fire is halogen free with low smoke and fume characteristics. There are many types and grades of these materials and when using them advice should be sought from our technical sales support team, please contact us on +44 (0) 345 605 4333.

Architectural powder coatings

These powder coatings are formulated to meet the particular requirements of exterior environments. They are inherently resilient and resistant to damage and chemical or corrosive attack, providing maximum protection to the substrate. When subjected to high levels of ultra violet light present within sunlight the coatings have excellent gloss retention and resistance to chalking. These coatings would normally be applied over a galvanised finish.

Clear powder coating on pre-galvanised steel

Pre-galvanised steel with a clear polyester resin powder coating has excellent weathering characteristics.

This is due to the hard powder coated finish, which gives good mechanical protection and excellent corrosion resistance, being bonded to a sub surface of zinc. The zinc giving protection against deep surface scratches by cathodic action.

Pre-galvanised Steel

This finish is described on page 126.

Clear Powder Coating

This is carboxylated polyester resin finish which is a different compound to the powder coated finish described opposite.

The application is the same as standard powder coating, namely it is applied as an electrostatically charged powder to the article which is then melted onto the surface and baked into a hard surface in a stoving oven.

The resultant surface finish gives a corrosion resistance in the ASTM B117 Salt Spray test of 500 hours with creepage of corrosion less than 2mm from the scribe mark.

Installation of services

IN THIS SECTION...

Cable tray systems

1. Design factors to consider
2. Loading graphs

Cable tray systems

Cable tray systems are intended for the support of a combination of cables, electrical equipment and/or communication system installations. Where necessary cable tray systems may be used for the segregation of cables.

Note : these systems are designed for use as supports for cables and not as enclosures giving full mechanical protection.

These systems are covered by BS EN 61537.

1 Design factors to consider

Consideration should be given to the following factors when undertaking the design of a support system although some of these (e.g. snow/wind loads) may not be relevant to every installation.

- (i) Distributed loads (eg. cables, pipes)
- (ii) Point loads
- (iii) Snow, wind and external forces
- (iv) Safety factor
- (v) Deflection
- (vi) Spacing of supports
- (vii) Location of couplers
- (viii) Installation of cables within a support system
- (ix) Earth protection
- (x) Electromagnetic compatibility (EMC)
- (xi) Thermal expansion and contraction

The following sections provide a wealth of useful information on each of these design aspects.

(i) Distributed loads

Before commencing the design process for a new installation it is usual to consider whether future changes in the pattern of demand for building services will impose increased loading requirements on the support system. If so, it is good design practice to allow both the physical space and sufficient load carrying capacity for the future addition of 25% more cables or other loading medium.

Estimation of cable loads

If full details of the cabling layout are available then the likely cable load can be calculated using either manufacturer's published information or the tables of cable weights and diameters which are given opposite. However, it is often necessary to select a tray design in the absence of accurate information on the likely cable load. To assist this selection process a useful approach can be to choose a likely size of tray and then to estimate the maximum cable weight which is capable of being contained within it. This estimate may be arrived at using the following guide :

Max. cabling capacity (kg/m) = cable laying area (m²) x 1 700

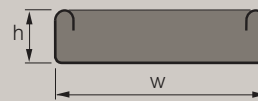

Cable laying area

Cable laying area (m²) = w (m) x h (m)
Applicable to cable tray

Note : this formula only provides an estimate of the maximum load which can be physically contained within a tray. The ability of that tray to support such a load depends upon the spacing of its supports.

Cable weights and diameters

Tables 1 and 2 below give typical weights and diameters (D) for PVC sheathed, steel wire armoured cables with stranded copper conductors.

Tables 3 and 4 give typical weights and diameters for PVC sheathed, unarmoured stranded copper power cables. Cables with XLPE (cross linked polyethylene) insulation are usually slightly lighter so the information given may also be used for these cables too.

For all other types of cable (e.g. paper insulated cable or cable with aluminium conductors) refer to the cable manufacturer's catalogue for details and guidance.

Values show approx. weight and diameter of typical cables.
D = Overall cable diameter.

Table 1 : PVC armoured power/control cables to BS 6346

Nom. area of conductor (mm ²)	2 core		3 core		4 core	
	kg/m	D in mm	kg/m	D in mm	kg/m	D in mm
1.5	0.3	12.3	0.3	12.8	0.4	13.5
2.5	0.4	13.6	0.4	14.1	0.5	15.0
4.0	0.5	15.1	0.5	15.8	0.7	17.8
6.0	0.6	16.5	0.7	18.0	0.9	19.2
10.0	0.9	20.1	1.0	21.2	1.2	22.8
16.0	1.0	21.9	1.2	23.1	1.7	26.3

Table 2 : PVC insulated and sheathed circular surface wiring

Nom. area of conductor (mm ²)	2 core		3 core		4 core	
	kg/m	D in mm	kg/m	D in mm	kg/m	D in mm
1.5	0.1	7.7	0.1	8.2	0.1	9.1
2.5	0.1	9.2	0.2	9.7	0.2	10.6
4.0	0.2	10.2	0.3	11.0	0.3	12.6
6.0	0.2	12.0	0.3	12.8	0.4	14.2
10.0	0.4	14.6	0.5	15.6	0.7	17.4
16.0	0.6	16.9	0.7	18.0	0.9	20.0

Table 3 : PVC unarmoured stranded copper power cables to BS 6346

Nom. area of conductor (mm ²)	2 core		3 core		4 core	
	kg/m	D in mm	kg/m	D in mm	kg/m	D in mm
25	0.7	18.4	1.0	20.4	1.3	22.7
35	0.9	20.0	1.3	22.4	1.7	25.0
50	1.2	22.2	1.7	25.4	2.3	28.6
70	1.7	24.6	2.4	28.4	3.1	32.2
95	2.3	28.2	3.3	33.1	4.3	37.2
120	2.8	30.9	4.0	36.0	5.3	40.6
150	3.5	34.1	4.9	39.7	6.5	45.0
185	4.2	37.8	6.1	44.1	8.0	49.8
240	5.5	43.2	8.0	49.6	10.6	56.2
300	7.0	47.2	9.7	55.0	13.2	62.5
400	8.5	53.2	12.6	61.4	16.7	69.6

Table 4 : PVC armoured stranded copper power cables to BS 6346

Nom. area of conductor (mm ²)	2 core		3 core		4 core	
	kg/m	D in mm	kg/m	D in mm	kg/m	D in mm
25	1.3	23.0	1.7	25.1	2.1	27.5
35	1.6	24.8	2.1	27.3	2.6	30.0
50	2.0	27.2	2.6	30.5	3.5	34.8
70	2.5	29.5	3.6	34.8	4.5	38.4
95	3.5	34.4	4.6	39.1	5.9	43.3
120	4.1	37.1	5.5	41.9	7.5	48.1
150	4.9	40.2	7.0	47.2	8.8	52.3
185	6.3	45.1	8.4	51.4	10.7	57.5
240	7.8	50.5	10.7	57.3	13.5	63.9
300	9.3	55.4	12.7	62.6	16.4	69.9
400	11.3	60.8	15.7	68.8	21.3	78.8

(ii) Point loads

Point loads may consist of permanent equipment, such as lighting luminaires, junction boxes or other switchgear, or temporary loads such as commissioning equipment or installation personnel (however, consider 'Safety during the installation phase' page 145). Analysis of uniformly distributed loads (UDL), such as cables or pipes is relatively simple but analysing the effect of a point load is quite complex; fortunately a simple alternative approach is available.

Firstly, one makes the reasonable assumption that the point load will be situated in the worst position at mid-span. The force this point load imposes can then be taken as equivalent to that imposed by a load of twice its value uniformly distributed along the span. Thus the point load can be converted to the equivalent uniformly distributed load which is then added to other UDLs to produce one total uniform load.

Example:

Point load = 30 kg

Support spacing = 3 m

UDL = 100 kg/m

UDL equivalent to 30 kg point load =

2 x Point Load = 2 x 30 kg = 60 kg = 20 kg/m

Total UDL = 100 kg/m + 20 kg/m = 120 kg/m

The suitability of a tray to carry this total load can then be considered using the loading graph information (see p. 134 to 135). Although this treatment does assume the point load will be in the 'worst case' position, the installer should, given discretion, always position any point load as close as possible both to a support and to either side flange, minimising the stress on the installation, as per the following illustration.

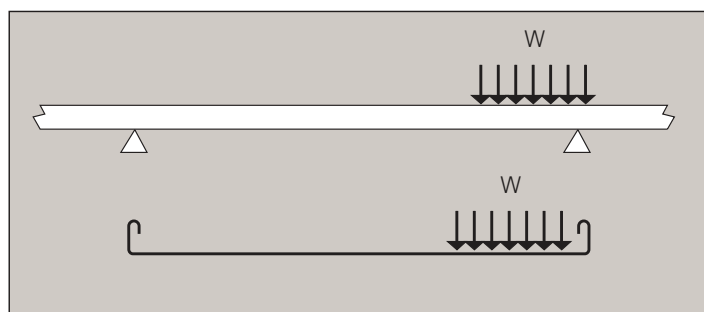

Single spans

For single spans the loading capability is also severely reduced. In this circumstance the safe working load (SWL) should, as a simple rule, be reduced to half that indicated by the loading graphs on p. 134 to 135, and there must be no joint in the span.

This derating of the loading capacity for either single spans or point loads depends to some extent upon the tray type and the intended span. If therefore the design calculations indicate this aspect is critical, more detailed information should be sought from Legrand, contact us on +44 (0) 345 605 4333.

(iii) Snow, wind and external forces

The loading graphs on p. 134 to 135 show the maximum safe working steady load for each type of support system. If the system is outdoors and must also sustain snow, ice, wind or other variable forces these must also be taken into account at the design stage.

Appropriate design data for UK weather conditions is given in British Standard BS EN 1991, see p. 146.

For snow and ice the appropriate extra weight as indicated by these standards must be added to the weight of the cable (and any point loads) to give a total working load; this should then be compared with the safe working load (SWL) for the tray using the graphs in this document.

The horizontal force imposed by a wind is proportional to the vertical surface area of the installation so particular care must be taken where cable tray will be mounted on edge. Where high winds are likely, large spans should be avoided.

High winds can also create a strong lifting force on tray or covers and this too must be borne in mind when installing covers in exposed locations. Ideally covers should not be installed temporarily, they should only be installed after the electrical installation has been completed and they must be properly secured immediately.

(iv) Safety factor

To arrive at a safe working load (SWL) for each type of equipment Legrand test their products to find the ultimate failure load. The SWL is obtained by dividing the load before failure by a factor of 1.7 minimum.

This safety factor may need to be increased by the designer depending upon the circumstances. For example, if the support system is expected to be subject to aggressive abuse a safety factor as high as three or more may be used. Such treatment is, however, the exception and care should be taken not to over-design the system by using an unnecessarily high safety factor.

(v) Deflection

The deflection of a cable tray under load is not directly related to its strength but it is obviously of aesthetic importance. For this reason it may be necessary to estimate the likely deflection whilst designing an installation, especially if it will be in a highly visible location. Experience has shown that in order to maintain a degree of deflection which is subjectively acceptable to the eye, the load on the cable tray will often be restricted to well below its safe maximum.

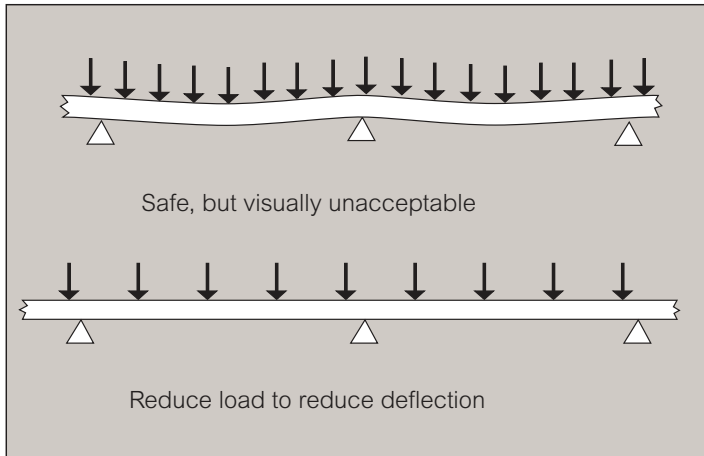

(vi) Spacing of supports

Services support installations are usually considered as multi-span arrangements but it is important to recognise that the loading capability of the system is not uniform from end-to-end. The strength of the two end spans in any run is much lower than that of intermediate spans, even when the ends are rigidly fixed. In many situations the end spans will be more lightly loaded anyway; if however they are not and the installation will be fully loaded from end-to-end then it is recommended that the support spacing of both end spans should be reduced to no more than three quarters that of intermediate spans. However it is not a mandatory requirement, but is both useful and advisable.

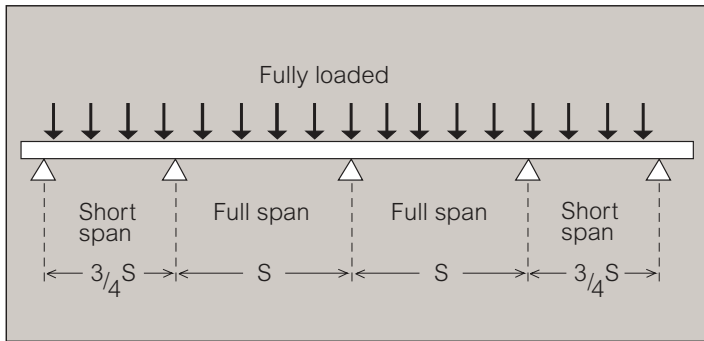

Sometimes the necessary support spacing may be dictated by the nature of the building fabric. If however the designer has discretion over the spacing of supports the loading graphs can be used to maximise this distance. This will reduce the number of support components and fixings that will be required, thus reducing the overall cost of the installed system.

Supports for Cable Tray

If light duty (SS) cable tray is being installed then in most circumstances a 1 m support spacing is ideal. Many light duty tray installations are intended to carry just one or two cables and often the tray supports will be mounted on the existing building fabric. However, where more substantial cable trays are being used it is often necessary to build a dedicated supporting structure; some attention to the design of this can provide tremendous economies in both purchasing and installation costs. On wider trays the maximum Safe Working Load can be increased by fitting an appropriate fishplate across the underside of each tray-to-tray joint.

For further information, contact us on +44 (0) 345 605 4333

Support of fittings

Cable tray fittings must always be provided with local support. The illustrations on pages 131 to 132 give recommended support positions.

(vii) Location of couplers

In practice it is often impossible to predetermine where the couplers will be located within a straight run of cable tray. However it is well worth making some effort to roughly plan their position during the early stages of installation.

The worst positions for the couplers is at mid-span. At these locations they will suffer the greatest stress. A mid-span joint should be particularly avoided on the end spans of an installation to minimise deflections.

The best position for joints in a continuous installation is on quarter of the span distance on either side of each point of support.

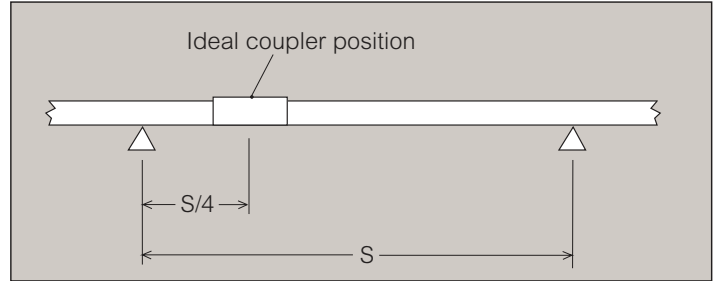

Loading graphs

Refer to loading graphs on pages 134 to 135.

Recommended support locations – cable tray

Large = tray widths 450 mm and above
 Small = tray widths 300 mm and below

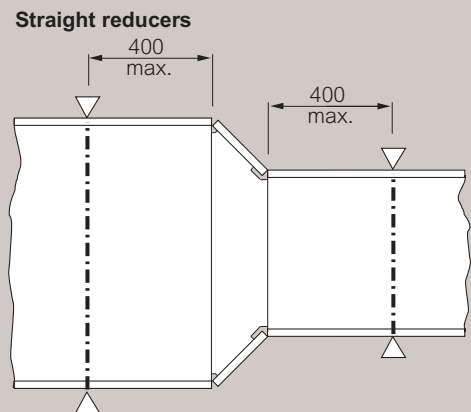
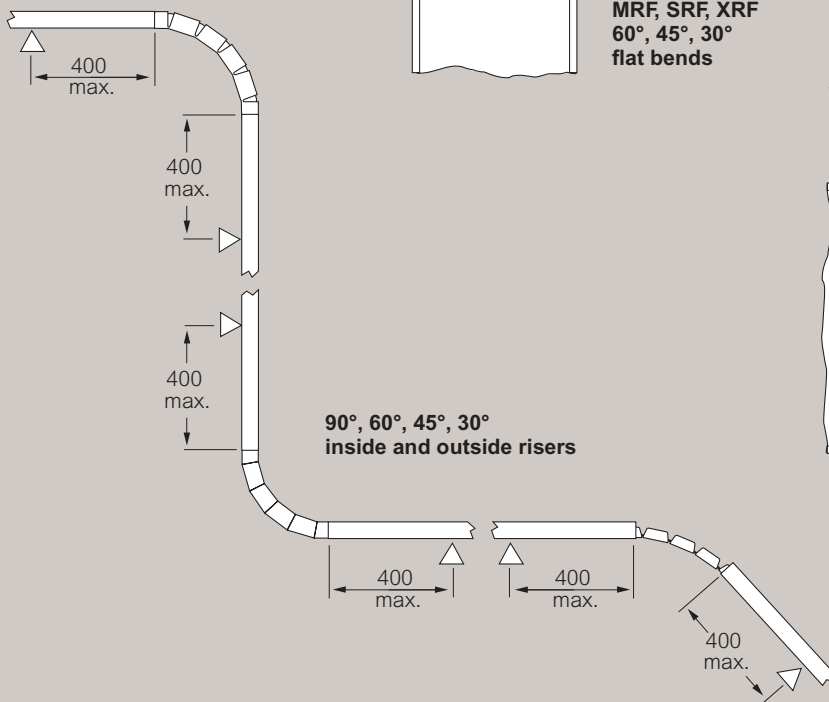
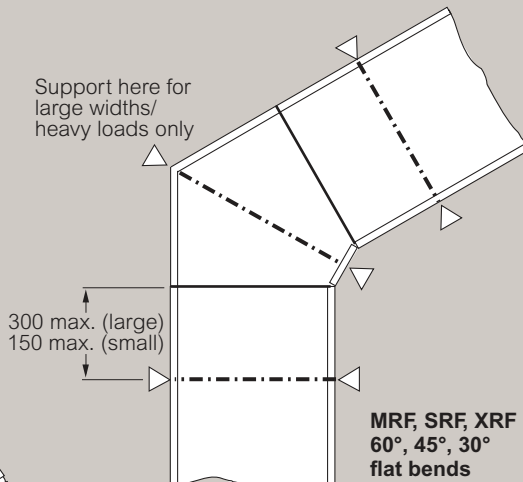
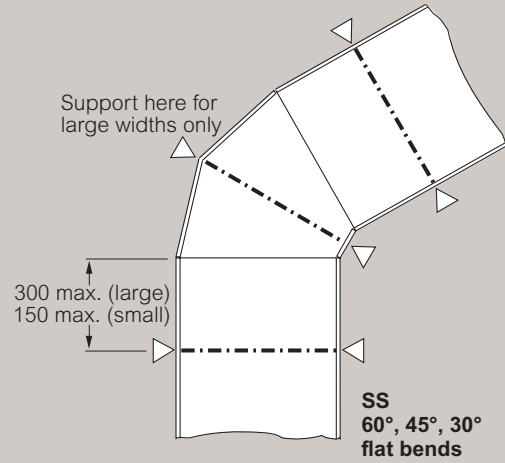
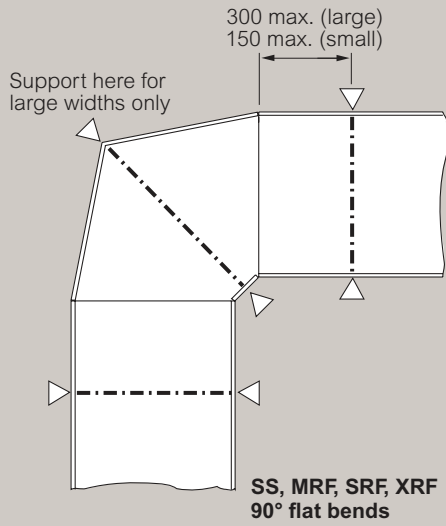

Recommended support locations – cable tray (continued)

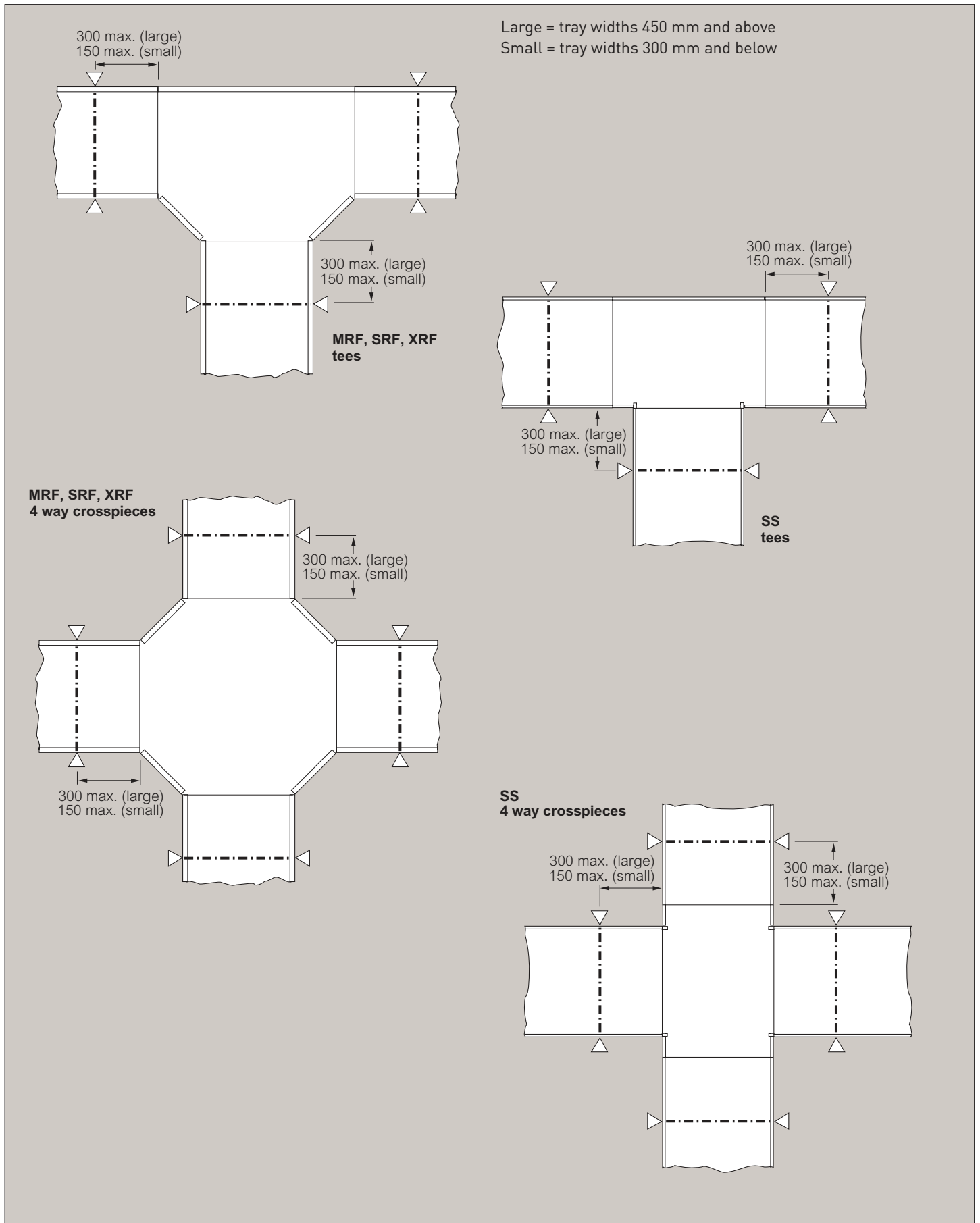

(viii) Installation of cables within a support system

Detailed guidance concerning the selection and use of appropriate electric cables is available from cable manufacturers, relevant standards (both British Standards and European Cenelec Standards) and the Wiring Regulations. However the following general comments may also be helpful.

Cables are designed for continuous operation within a range of ambient temperatures; attention must be paid to the ventilation arrangements to ensure that the maximum temperature is not consistently exceeded. Where cable routings pass through enclosed ducts it is important to ensure that the ducts are large enough to avoid overheating.

Cable support spacing

Cables must either be continuously supported or supported at intervals which are no more than those given in Table 5 below. Cables should not themselves be used as a support or as a restraint for other loads.

Table 5

Cable diameter (mm)	Support spacing (mm)	
	Horizontal ⁽¹⁾	Vertical ⁽²⁾
Below 100	250	400
10 to 15	300	400
16 to 20	350	450
21 to 40	400	550

(1) From horizontal through to 60° inclination

(2) From 60° inclination (30° from vertical) through to vertical

Fixing of cables to cable tray

Moulded plastic cable ties, cable cleats or perforated metal strapping are most commonly used for attaching cables to cable tray. The slots in the tray are designed to accept M6 fasteners and the perforation pattern will allow banding up to 18mm wide to be used.

Minimum bending radius of cables

All cables have a minimum bending radius beyond which they should not be bent either during handling or when finally installed. Details of the minimum bending radius for various types of cable are given in Table 6 below.

Table 6

Type of cable (mm)	Minimum bending radius D = cable diameter
Unarmoured cable, D < 10 mm	3D
Unarmoured cable, 25 mm < D < 10 mm	4D
Unarmoured cable, D < 25 mm	6D
Armoured cable to BS 5467, BS 6346 and BS 6724 (LSF cables)	8D

Radius of fittings

On a cable support system the size and type of cables must be considered to ensure that the radius of the support fittings exceeds the minimum bending radius of the cables themselves. The table above gives a general guide to these minimum values. Cables must not be accidentally bent to a tighter radius during installation.

(ix) Earth protection

Cable tray is deemed to provide continuous support to any cables installed upon it but, because it is not completely enclosed, it does not offer mechanical protection. For this reason unsheathed, single insulated power cables should not be installed on tray, all cables should have some mechanical protection in the form of PVC sheathing, steel wire armouring or a copper covering (MICC). Where moisture may be present, copper covered cables must also be PVC sheathed to avoid electrochemical corrosion between the copper and the cable support system.

Cable tray can be specifically designed to act as a circuit protective conductor (CPC), which connects exposed conductive parts of equipment to the main earth terminal and will thereby provide some protection against electric shock. For this to be acceptable the cross-sectional area of the cable support must exceed a value obtained by calculation, the formula for this calculation being given in Regulation 543-01-03 of the Wiring Regulations BS 7671. This formula takes into account the fault current of the circuit, the nature of the cables themselves and the operating time of the disconnecting device used to protect against excessive currents. Other features, such as protection of the support system against mechanical damage and corrosion (to ensure the CPC remains intact), visual identification that the support system is being used as a CPC and the impedance of the circuit must also be considered by a competent electrical engineer before tray can be used as a CPC.

If armoured cables (with an integral CPC) are installed on a tray and the support system is not being used as a protective conductor, then it is generally considered as a metal part which is neither extraneous nor exposed; continuity is not an issue in this situation. Normal tray assembly methods are adequate and BS 7671 (the Wiring Regulations) impose no requirement for continuity of such metal parts unless they are being used as a protective conductor.

If unarmoured cables are installed on a tray installation which is not being used as a protective conductor, consideration should be given to the possibility of damage to these cables, causing the tray to become live and hence the need to earth the support system.

The continuity of properly fixed tray joints is such that earth continuity connectors (bonding connectors) are not necessary for any general tray application; however in special locations or hazardous areas (as described in BS 7671: Part 7) earth continuity connectors may be required, subject to consideration by a competent electrical engineer.

(x) Electromagnetic Compatibility (EMC)

In normal use cable tray is considered as passive in respect of electromagnetic influences. The installation of current carrying media may cause emissions and these media may also be influenced by electromagnetic signals from elsewhere but the degree of influence will depend on the nature of the installation and the apparatus connected to the system.

A draft technical report IEC1000-S-1 provides details of the cable separation required according to the type of signal being considered and the IEE Guidance Note No.1 provides further information on the subject of EMC. However, as a basic principle, if power and signal cables can be run separately on different trays then this will significantly reduce any possibility of one electrical circuit having any undesirable influence upon another.

(xi) Thermal expansion and contraction

In locations where large variations in temperature are anticipated the design of the support system should make allowance for changes in the length of the support system due to the expansion and the contraction of the metal.

2 Use of loading graphs

Provided the relevant graph column lies above the intersection of the load/span lines, the proposed arrangement is acceptable (see opposite).

The deflection will often be less than 1/200th of the span and in most cases it will be less than 1/360th of the span.

However where point loads will be imposed, or where there are short runs with three spans or less, the deflection will increase and the safe working loads (SWL) may need to be reduced from the values given.

Further information on this subject is given on pages 128 to 130. These graphs should not be extrapolated to longer spans than shown, nor should they be used for situations where the bed of the tray is vertically orientated. In exposed situations the use of long spans requires particularly careful consideration.

Any further information on loads and deflections for such circumstances should be sought from Legrand, contact us on +44 (0) 345 605 4333.

The values given in this document have been obtained from extensive testing of our cable support equipment. They are given as a guide, so that their customers may use Legrand's products to the best advantage; they are nevertheless average figures which are given in good faith, but without accepting any liability in contract, tort or otherwise in the event of different performance by equipment which is actually supplied.

The cable support systems in this document are not designed for use as walkways or to support personnel during cable installation.

Loading graphs

The loads shown on all graphs are the safe recommended maximum loads that can be applied and must include wind, snow and any other external forces in addition to the cable load.

The graphs show the maximum load for tray installed at a support spacing within its recommended range.

When the graph column is above the intersection of the required load and span lines, the support equipment is suitable for use within those load and span conditions.

The graphs shown are for hot dip galvanised finish.

When installed, inner span deflection will vary depending on joint positions but will typically be about half of test end span deflection shown on following page.

SS light duty

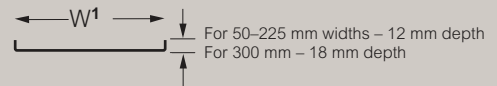

50-300 mm width trays

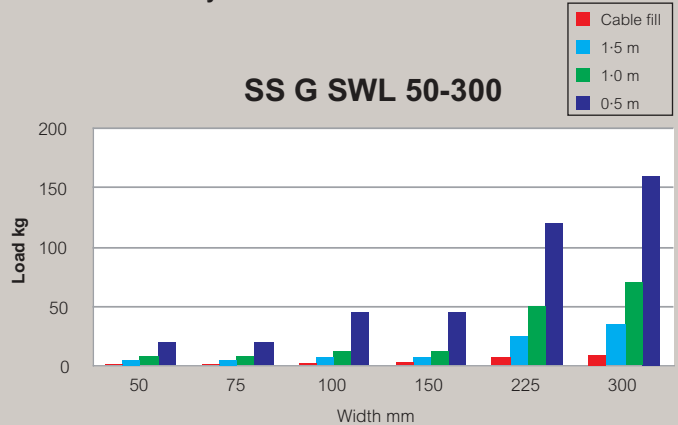

1 : W = For widths see selection charts (p. 12-15)

MRF medium duty

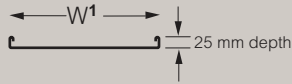

50-300 mm width trays

MRF G SWL 50-300

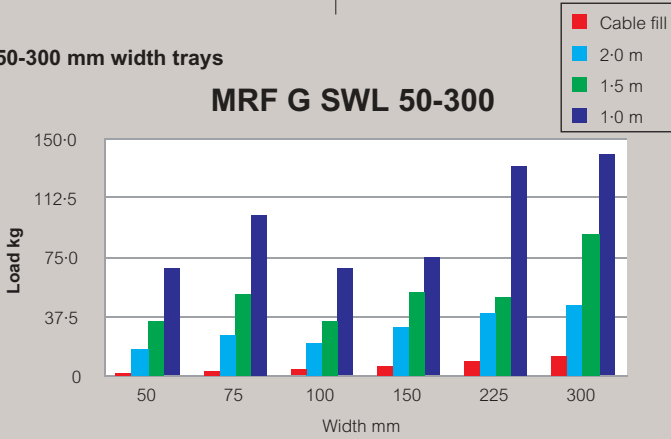

Table shown with results up to 300 mm wide obtained using the Swiftclip

450-900 mm width trays

MRF G SWL 450-900

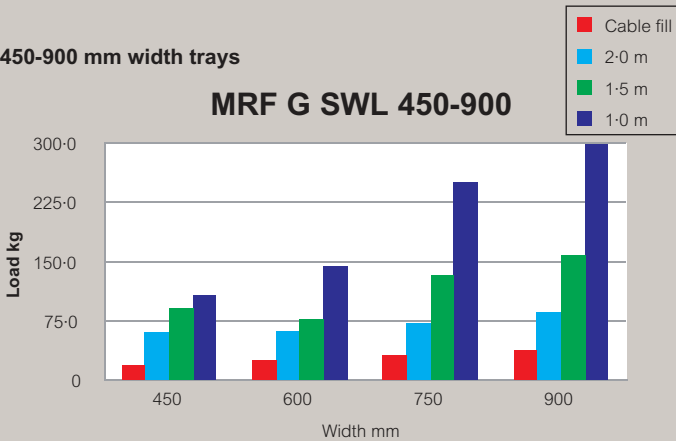
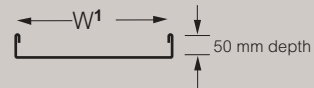

Table shown with results of 450 mm wide and above using Swiftgrips and UF fishplates

1 : W = For widths see selection charts (p. 12-15)

SRF heavy duty



75-300 mm width trays

SRF G SWL 75-300

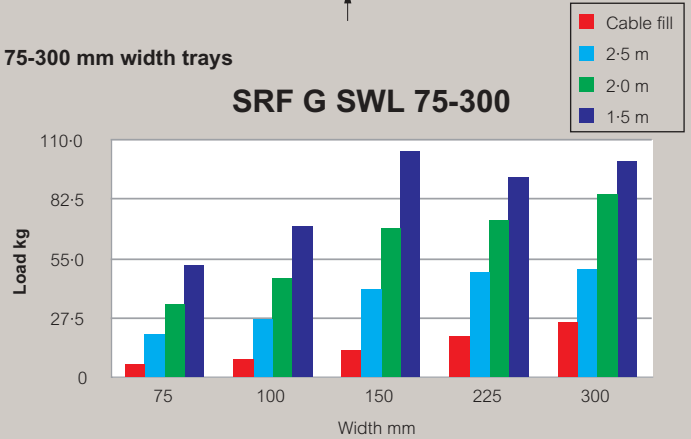

Table shown with results up to 300 mm wide obtained using the Swiftclip

450-900 mm width trays

SRF G SWL 450-900

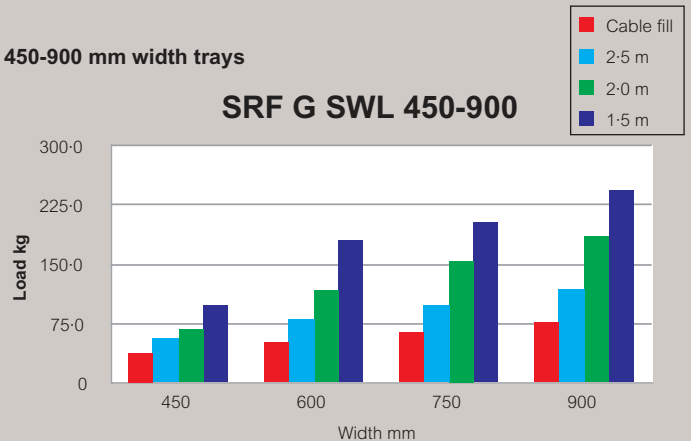
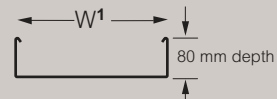

Table shown with results of 450 mm wide and above using Swiftgrips and UF fishplates

XRF extra heavy duty



100-600 mm width trays

XRF G SWL 100-600

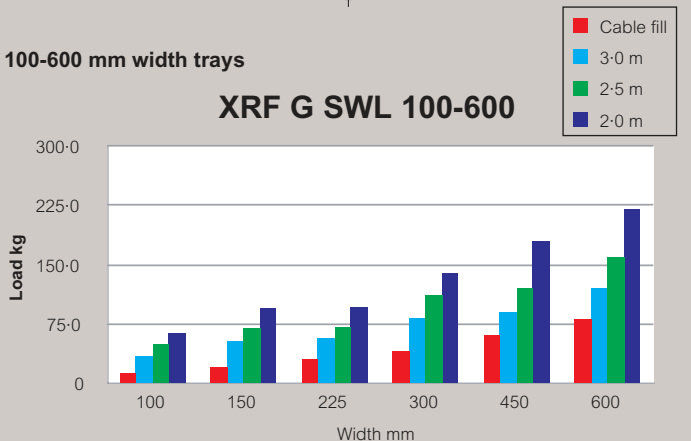

On XRF lengths the graph shows the maximum safe working load when a fishplate is fitted across the underside of each length-to-length joint. Typical cable loads which are normally 50% of the maximum would not require a fishplate

Structural support characteristics

including channel support systems

Structural characteristics

1 Cable tray

On many occasions cable tray is installed in circumstances where it will only ever carry a light cable load, possibly just one or two cables, and its main role is to physically secure and protect its contents. In these situations it is often the inherent ruggedness or the aesthetics of the tray design which bear most heavily on the specification decision. However, when a support system is required to be more heavily loaded it is useful to have a knowledge of the theoretical aspects of rudimentary structural design in order to ensure that the completed system does fulfil its purpose with the greatest safety and economy.

2 Beams

Any installed tray system can be considered structurally as a loaded beam; four basic beam configurations may be found in a typical installation :

- Simple beam
- Fixed beam
- Continuous beam
- Cantilever beam

Simple beam

A single length of cable tray mounted on, but not fastened to, two supports represents a simple beam, which will bend as any load is applied to it with the supports offering no restraint to this bending.

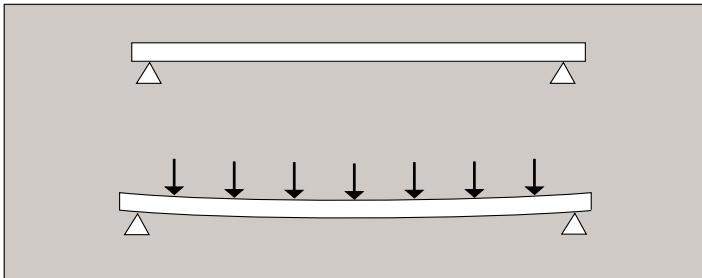

This simple arrangement is fairly onerous and does not realistically model many real-life installations; thus the load/deflection information given in this document is based upon more typical multi-span configurations, which incorporate joints too. However, if an unjointed single span does actually occur the safe working load (SWL) can, as a practical guide, be taken as 1/2 of that indicated by the loading graphs.

IN THIS SECTION...

Structural characteristics

1. Cable tray
2. Beams
3. Columns
4. Deflection

Designing support systems

1. Ceiling to floor applications
2. Ceiling mounted applications
3. Wall mounted applications
4. Floor mounted applications

Swiftrack channel support

1. Channels
2. Channel nuts
3. Framework brackets
4. Fasteners
5. Cantilever arms
6. Maximum safe recommended loadings
7. Channels used as beams
8. Channels used as columns
9. Fully restrained and unrestrained loads
10. Beam loads

Fixed beam

A fixed beam arrangement is a single structural member with both ends fastened rigidly to supports. Compared with a simple beam this degree of restraint does significantly increase the ability of the beam to carry loads but it is unlikely that cable tray can, in practice, be secured sufficiently rigidly to be considered as a fixed beam.

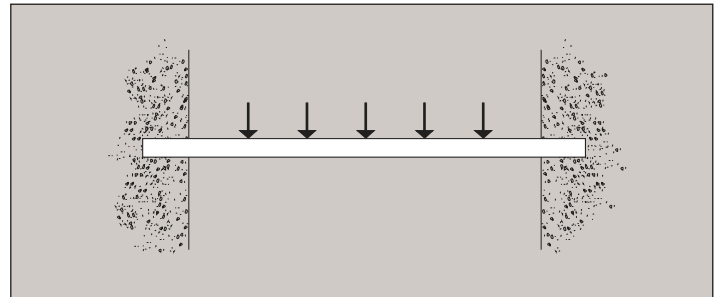

However, in the context of a complete tray system the main importance of the fixed beam configuration is that some appreciation of its properties, along with those of a simple beam arrangement, will assist the designer to understand the more complex behaviour of a continuous, multi-span cable tray installation.

Continuous beam

A typical multi-span tray installation behaves largely as a continuous beam and the greater the number of spans the closer the similarity. However in practice a run must contain joints and it can also never be considered of infinite length so it is important to appreciate how its characteristics do vary from span to span and how these variations should be taken into account when designing the installation.

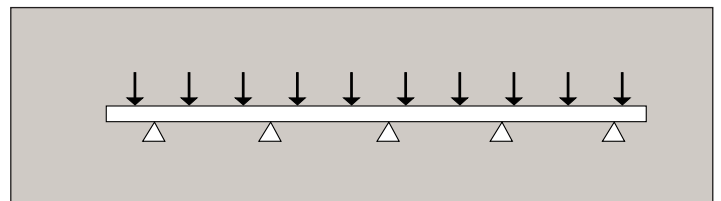

When a run of cable tray is loaded uniformly from end to end the load on each span is effectively in balance with the loads on the adjacent spans.

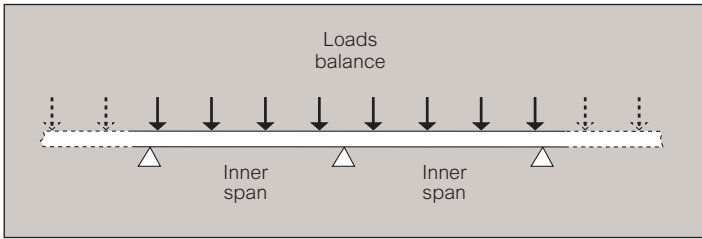

This causes the inner spans to behave substantially as fixed beams imparting to them a considerable load carrying ability. However the two end spans of the installation are not so counterbalanced thus they perform more akin to simple beams, with consequently lower load carrying capabilities.

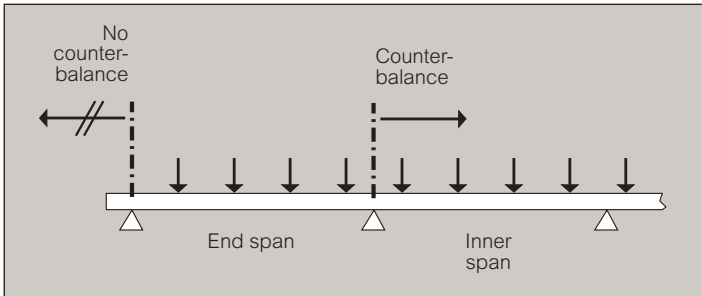

However if this is not the case the support spacing on the two end spans should advisably be reduced to $\frac{3}{4}$ of the intermediate spans in order to compensate (see page 130, spacing of supports).

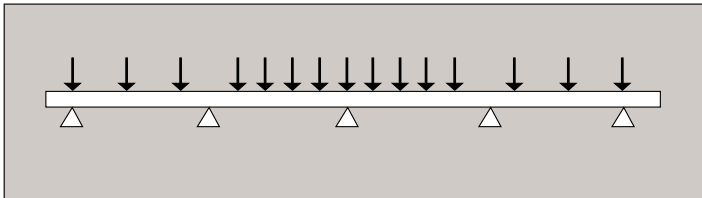

Cantilever beam

This type of arrangement most commonly occurs with the brackets which are used to support cable tray, these being fixed to the structure at one end only.

For cable tray installations it is usual to consider the cable load to be uniformly distributed along the length of the cantilever arm (i.e. across the width of the tray); however, if cables will be bunched then their combined weight effectively acts as a point load on the arm so the bunch should, ideally, be laid nearest the supported inner end.

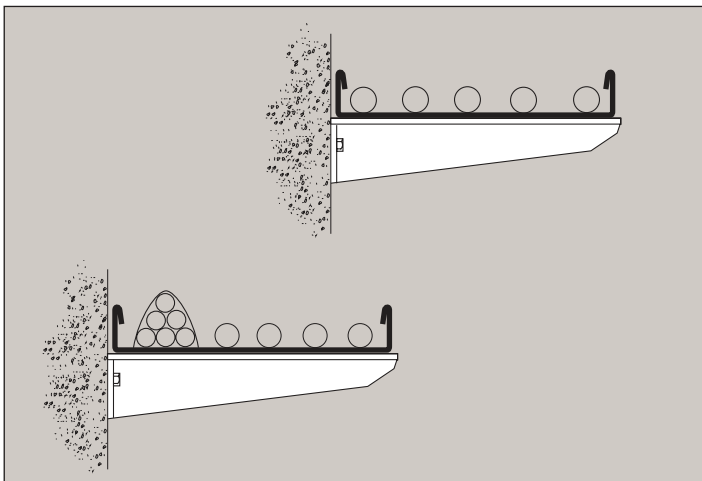

3 Columns

Any vertically arranged component, whether tray or channel, acts structurally as a column; however it is not usual to consider tray in this way because it is not designed for this purpose.

Swiftrack channel sections, in both single and multiple configurations, are however frequently arranged as vertical columns and the properties of these sections are both consistent and well known, making them suitable for an analytical approach to be used.

The downward load which can be applied to the end of a column is proportional to the compressive strength of the material from which it is made, but will reduce as the column gets longer. However there are few real applications where no loads are applied from other directions and since the effects of such loads are very significant it is important to consider the totality of the intended structure rather than focus simplistically only on the loads applied down the column.

Proper structural analysis must take detailed account of any side forces or eccentric loads caused by cantilever arms or other brackets fixed to the vertical channel. Such calculations must be carried out by a qualified engineer. The necessary data on the structural properties of the various channel sections is given on page 138, 'Designing support systems'.

4 Deflection

As discussed earlier (page 129, Deflection), the deflection of a tray under load is not directly related to its strength. However deflection is directly proportional to the applied load, so doubling the load will double the consequent deflection.

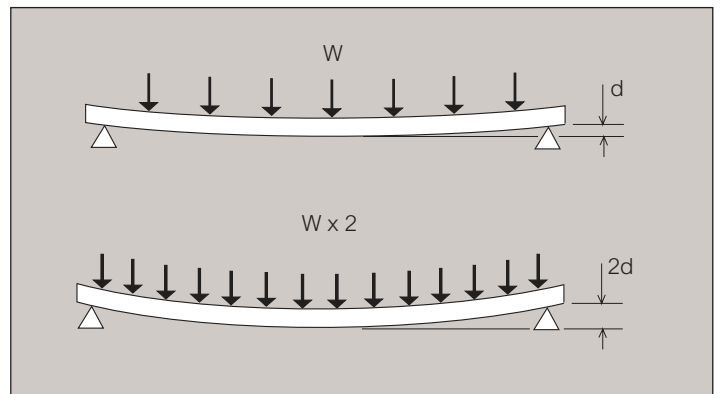

Any point load will have a magnified effect upon deflection. For a point load placed at mid-span (the worst position) the deflection will be approximately double that caused by the same load uniformly distributed along the span, although this value will vary depending upon the coupler and support positions.

Designing support systems

Swiftrack channel support system includes a range of versatile components which link together to provide support for any building services, including tray, ladder, trunking, piping, sprinkler systems and heat/ventilation ducting. Assembled on site, without welding, Swiftrack can be broken down into various elements. Each element needs to be checked to ensure the following :

- It can safely support the loads being imposed upon it (see p. 142-143)
 - The proposed fixing to adjacent elements can also support the required loads (see p. 142)
- Conforms to BS 6946

1 Ceiling to floor applications

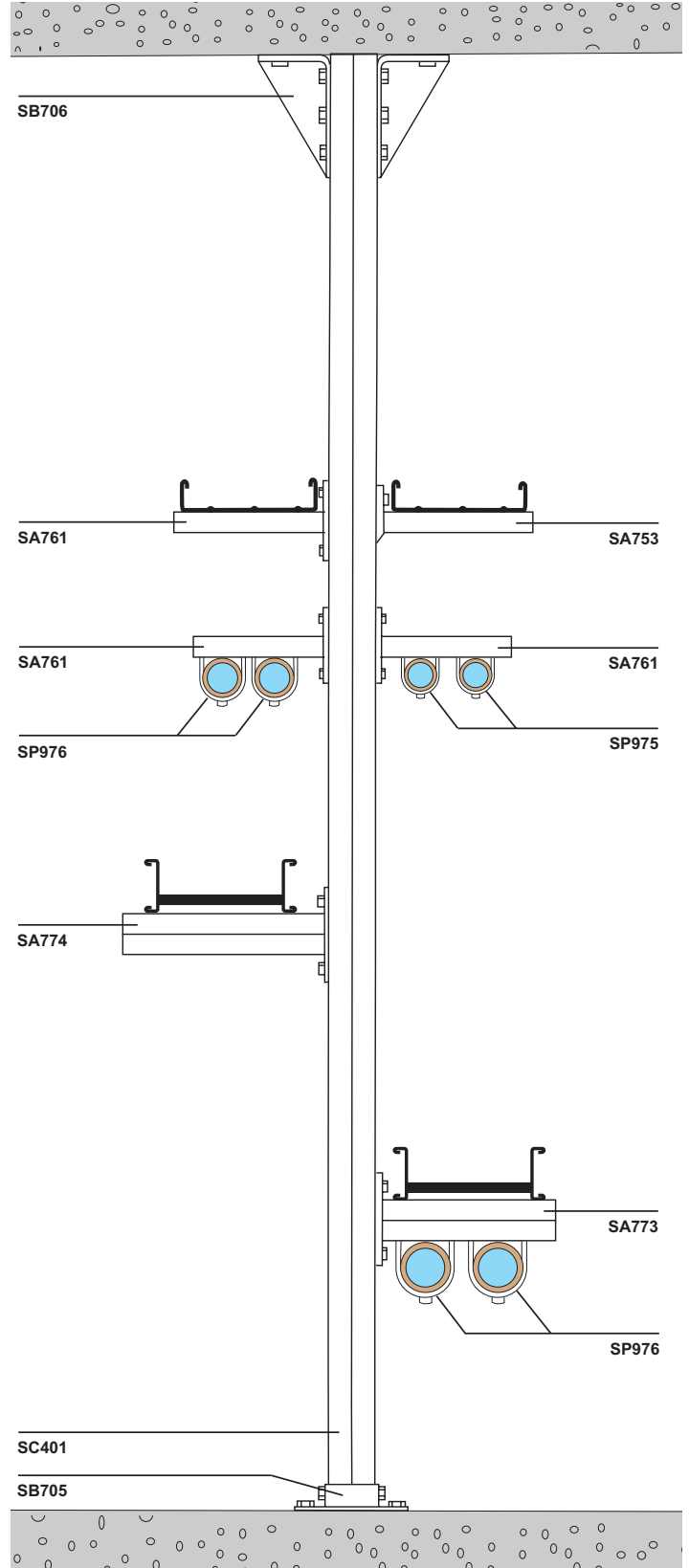
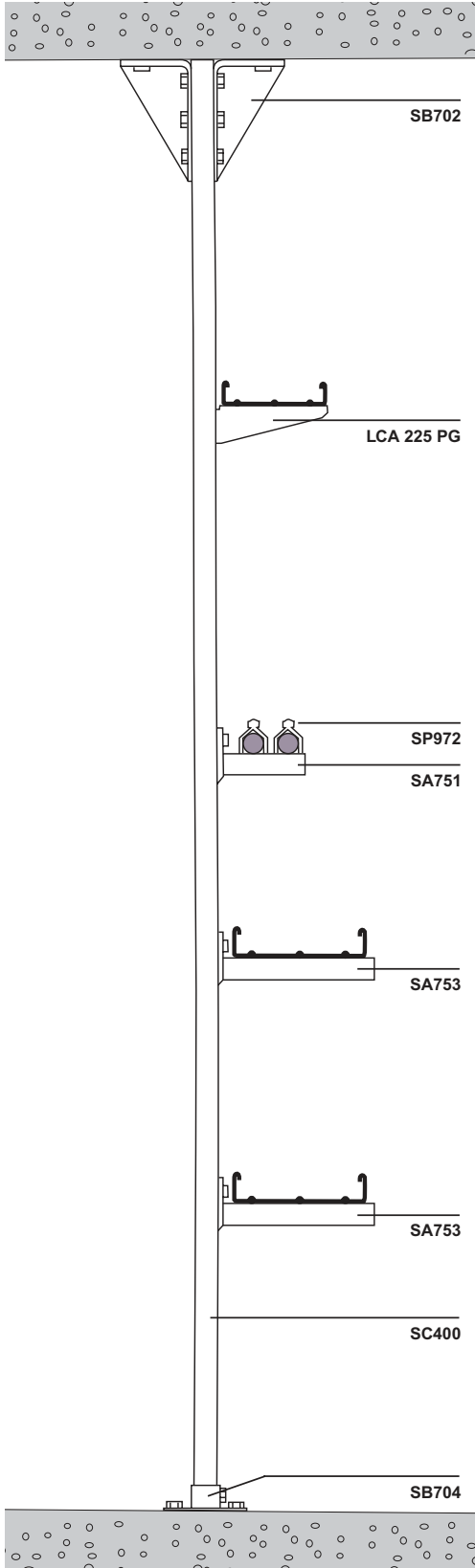

2 Ceiling mounted applications

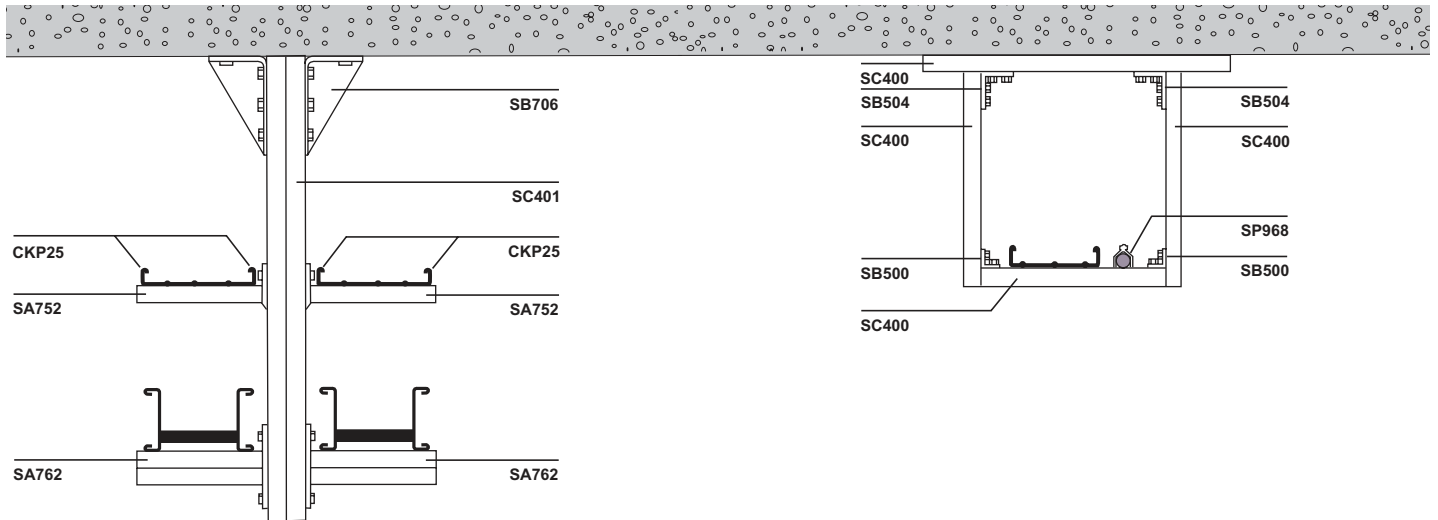

3 Wall mounted applications

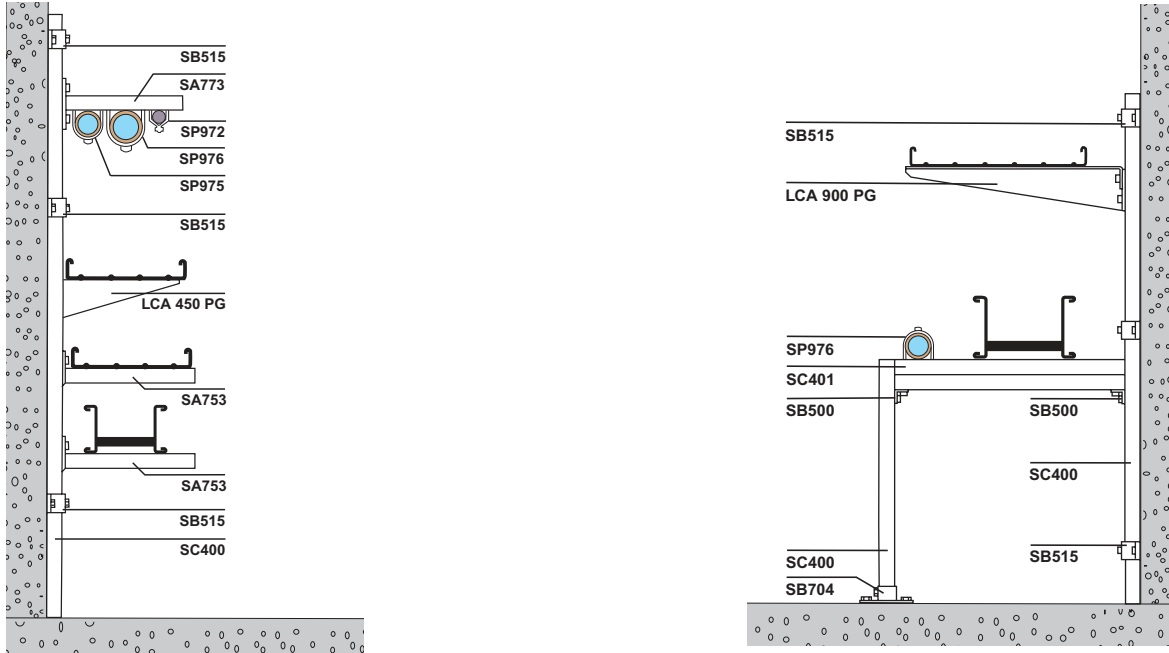

4 Floor mounted applications

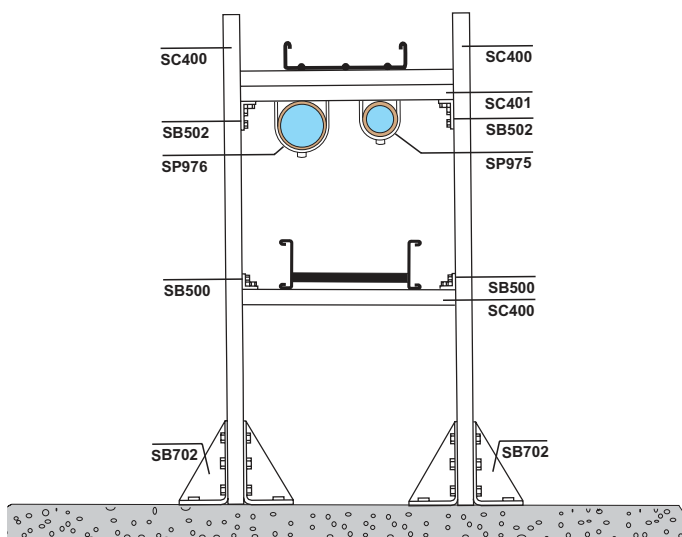

Swiftrack channel support

1 Channels

Standard channels are cold rolled to BS 6946 from 2.5 mm pre-galvanised mild steel to BS EN 10346 : 2009 grade S250GD + Z275.

Light gauge channels are cold rolled from 1.5 mm pre-galvanised mild steel to BS EN 10346 : 2009 grade S250GD + Z275.

Back-to-back channels are formed by spot welding together two finished single channels at 150 mm centres under controlled conditions to BS EN 1993-1-3 : 2006. All welds and spot welds are suitably protected.

The standard lengths for single or multiple channels are 3 m and 6 m.

Minimum yield strength, Y_s : 250N/mm²

Minimum ultimate strength : 350N/mm²

Minimum design strength, P_y : 250N/mm²

Section properties

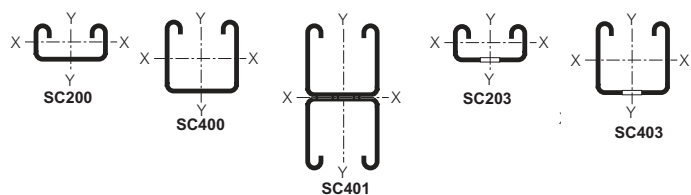

Cat. Nos.	Wt kg/m	A mm ²	I ^{xx} mm ⁴	Z ^{top} (min) mm ³	Z ^{bottom} (max) mm ³	r ^{xx} mm	I ^{yy} mm ⁴	r ^{yy} mm
SC200	1.8	219	10779	862	1330	7.1	49776	15.1
SC203	1.6	219	8960	794	961	6.4	49318	15.0
SC400	2.6	322	67157	2857	3772	14.5	88783	16.6
SC401	5.3	645	339300	8215	8215	23.0	177566	16.6
SC403	2.4	322	57221	2645	2909	13.3	88325	16.5

Wt = weight of section (kg/m)

A = cross-sectional area (mm²)

I^{xx} = moment of inertia = second moment of area (mm⁴)

Z^{top} = section modulus about xx axis (mm³)

Z^{bottom} = section modulus about xx axis (mm³)

r^{xx} = radius of gyration (mm)

I^{yy} = moment of inertia = second moment of area (mm⁴)

r^{yy} = radius of gyration (mm)

xx = about xx axis

yy = about yy axis

2 Channel nuts

The safe working loads for zinc plated channel nuts only.

Slip M10 : 3.0kN

M12 : 3.5kN

Pullout M10 : 6.0kN

M12 : 8.0kN

Safety Factor 3 when tested to BS 6946

Torque tightened to : M10 : 5.5 kgf.m (40 ftlb)

M12 : 7 kgf.m (50 ftlb)

3 Framework brackets

Brackets are manufactured to BS 6946.

Unless otherwise stated, brackets are made from 5 or 6 mm thick steel to BS EN 10025 Grade S275JRC.

Material Properties

Minimum yield strength : 275 N/mm²

Maximum Loads

Maximum loads for individual brackets are given with the illustrations on pages 108 to 111. In most cases the mode of failure will be slippage of the bracket along the channel. However there are few channel/bracket combinations where the maximum load is dependent upon the strength of the bracket itself. Only M10 or M12 channel nuts and bolts should be used for the attachment of load-bearing brackets.

4 Fasteners

Fixing brackets and supports to Swiftrack channel

Standard fasteners for Swiftrack are high tensile hexagon head setscrews to BS 3692-8.8, these being zinc plated to BS 3382 : Part 2.

Channel type	Fitting thickness	Recommended fastener ⁽¹⁾
Deep channel SC400 series	6 mm and 8 mm 5 mm and 6 mm	M10 or M12 x 35 mm ⁽²⁾ M10 or M12 x 20 mm
Shallow channel SC200 series	7 mm and 8 mm 5 mm and 6 mm	M10 or M12 x 25 mm ⁽²⁾ M10 or M12 x 20 mm

(1) The use of too long a fastener will prevent proper tightening because the bolt end will foul the bottom of the channel before the head tightens down on the fitting

(2) When fastener brackets other than Swiftrack, longer bolts may be required if the bracket thickness is greater than 8 mm

Fixing tray to supports

Use M10 high tensile hexagon head setscrews. Screws should be 20 mm long for shallow channel and 35 mm long for deep channel.

5 Cantilever arms

Maximum uniformly distributed loads for individual cantilever arms are given on page 108. However, should the loading not be uniform then the safe limit can be obtained by calculating the bending moment produced by the intended loads and comparing this with the maximum permissible bending moment for the relevant arm.

45 kgf.m for SA750 - SA755 and SA757

52 kgf.m for SA760 - SA766

95 kgf.m for SA770 - SA776

To obtain the bending moment resulting from any point load, multiply the size of the load by its distance from the inner end of the arm (see illustration A).

If several point loads exist then the total bending moment will be the sum of the individual bending moment produced by each point load (see illustration B).

If some part of the total load applied to an arm is uniformly distributed along a section of the arm only, then this part load can be treated as a point load acting at the mid-point of that section of arm to which it is applied (see illustration C).

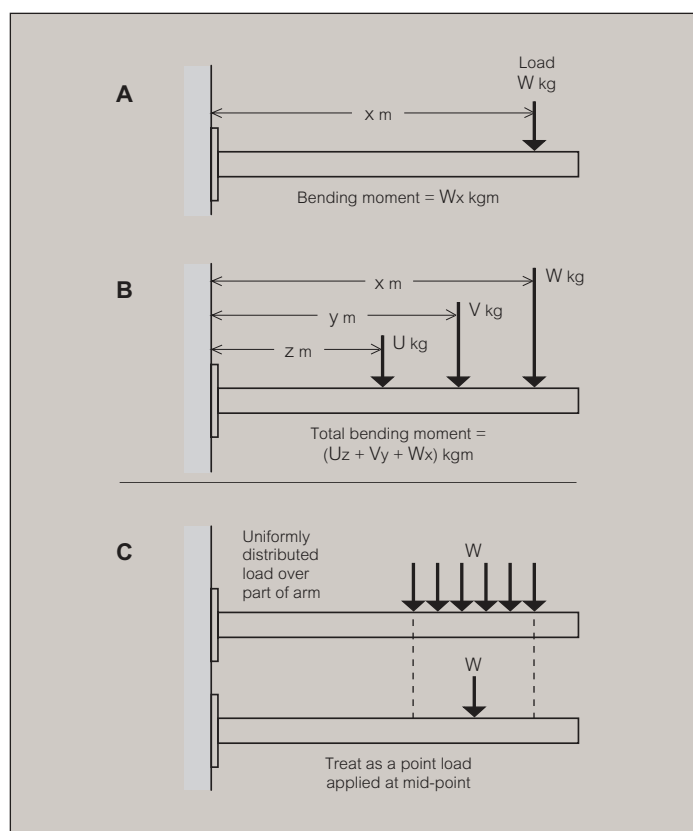

Note

Assumes loads are rigidly fixed to cantilever arms in such a way as to prevent the arms from twisting.

6 Maximum safe recommended loadings

(Based upon a load factor of 1.6 for hot dip galvanised unrestrained condition as specified in BS EN 1993 - 1-3 : 2006)

Cantilever arms

Cat. Nos.	Unit weight (kg)	Arm length (mm)	Maximum uniformly distributed load (kgf)	Point load at outer end (kgf)
SA750	0.64	150	350 ⁽¹⁾	303
SA751	0.85	225	350 ⁽¹⁾	198
SA752	1.03	300	304	152
SA753	1.42	450	202	101
SA754	1.81	600	150	75
SA755	2.20	750	110	55
SA757	2.60	900	90	45



Values assume the tray or other loading medium is rigidly fixed to cantilever arm

Cantilever arms, universal

Cat. Nos.	Unit weight (kg)	Arm length (mm)	Maximum uniformly distributed load (kgf)	Point load at outer end (kgf)
SA760	0.64	150	700 ⁽¹⁾	350
SA761	0.85	225	456 ⁽¹⁾	228
SA762	1.03	300	350	175
SA763	1.42	450	230	115
SA764	1.81	600	170	85
SA765	2.20	750	136	68
SA766	2.60	900	110	55

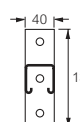

Values assume the tray or other loading medium is rigidly fixed to cantilever arm

Cantilever arms, double channel

Cat. Nos.	Unit weight (kg)	Arm length (mm)	Maximum uniformly distributed load (kgf)	Point load at outer end (kgf)
SA770	1.14	150	700 ⁽¹⁾	648
SA771	1.68	225	700 ⁽¹⁾	420
SA772	2.02	300	650	325
SA773	2.90	450	430	215
SA774	3.78	600	320	160
SA775	4.66	750	250	125
SA776	5.60	900	200	100

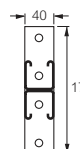

Values assume the tray or other loading medium is rigidly fixed to cantilever arm

Note

The loads for stainless steel cantilever arms are 60% of those given in the tables, except those marked (1) where the limit is 50%.

Cantilever arm loads detailed in the tables above are for M12 screws and channel nuts.

Assumes loads are rigidly fixed to cantilever arms in such a way as to prevent the arms from twisting.

7 Channels used as beams

The maximum safe load for a channel can be calculated knowing the strength of the steel (yield stress). Alternatively, if the appearance of the channel under load is considered important, then its deflection can be kept within visually acceptable limits.

Deflection limitations may render a lower recommended loading than that calculated from the strength of the steel.

Thus the two alternative approaches are:

- 1) To apply a maximum mid-span deflection of 1/200th of the span.
- 2) To place no limit on deflection and to apply a maximum load derived from calculations which include both the minimum yield stress of the steel and a safety factor (1.6).

Details of the maximum recommended uniformly distributed and point loads under both of these conditions are given in the table on page 143; these are provided for both restrained and unrestrained conditions (see opposite) and they apply to the worst situation of a simple single span only.

If in practice loads are neither uniformly distributed across the complete beam nor imposed at mid-span only, it is still possible to use a safe approximation and assess the suitability of a channel section. Do this by assuming that all loads are point loads imposed at mid-span only, and then consider the point load data in the table. This approximation will render a cautious result, which is nevertheless sufficient in most cases to show that a channel is satisfactory.

However, if it does yield an unsatisfactory result check with Legrand, as the degree of inherent caution is such that the design may still be safe. Legrand will be pleased to recheck your calculations, using your intended loadings – contact us on +44 (0) 345 605 4333.

The data provided in the table on page 143 is calculated in accordance with BS 5950 Part 5.

8 Channels used as columns

It is rare that any loads will be applied only to the end of a vertical column; most practical loading conditions involve the use of brackets and fittings attached to the open side of the channel. Loads applied in this way will produce a combined axial force down the column and a bending force on the side of the column which will reduce the allowable maximum load. The effects of such eccentric loadings should be carefully checked in accordance with standard design practice as given in BS 5950 Part 5.

Legrand will be pleased to give further advice and assistance on request – contact us on +44 (0) 345 605 4333.

9 Fully restrained and unrestrained loads

There are two alternative approaches to providing information on the structural strength of channel section used as beams.

Data is sometimes given on the basis of a fully restrained condition, which assumes that the channel section is in some way completely prevented from twisting under load (see illustration A). Alternatively data may be given on the basis of an unrestrained condition which assumes that, because no channel is perfect, placing it under load may result in some twisting taking place even though the ends of the channel are firmly secured (see illustration B).

Because the channel is constrained to remain in the optimum position, data given on a fully restrained basis will, for larger spans, suggest that a far higher load can be applied than with the unrestrained condition.

Both alternative sets of data are given in the table on page 143; however, unless positive intermediate restraint is applied to completely prevent any twisting it is recommended that the data for unrestrained channels, given in the table opposite, should normally be used.

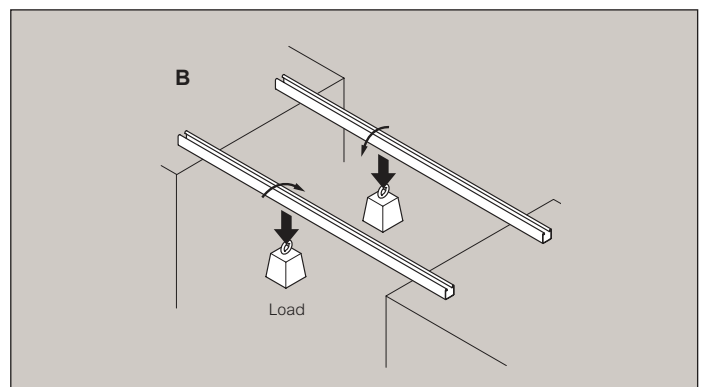
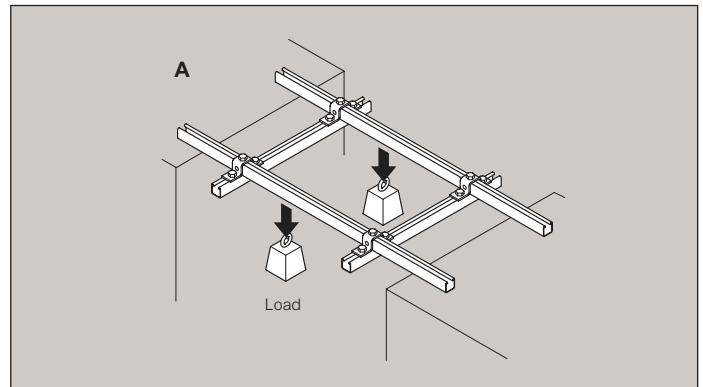

10 Beam loads

Cat. Nos.	Distance between supports (m)	Laterally unrestrained condition				Fully laterally restrained condition			
		Safe maximum loads		Maximum deflection of span/200		Safe maximum loads		Maximum deflection of span/200	
		Uniformly distributed across span (kgf)	Point load at mid-span (kgf)	UD load (kgf)	Point load at mid-span (kgf)	Uniformly distributed across span (kgf)	Point load at mid-span (kgf)	UD load (kgf)	Point load at mid-span (kgf)
SC400	0-20	700 ⁽²⁾	700 ⁽²⁾	700 ⁽²⁾	700 ⁽²⁾	700 ⁽²⁾	700 ⁽²⁾	700 ⁽¹⁾	700 ⁽¹⁾
SC200	0-20	687	343	687 ⁽¹⁾	343 ⁽¹⁾	687	343	687 ⁽¹⁾	343 ⁽¹⁾
SC401	0-20	700 ⁽²⁾	700 ⁽²⁾	700 ⁽²⁾	700 ⁽²⁾	700 ⁽²⁾	700 ⁽²⁾	700 ⁽¹⁾	700 ⁽¹⁾
SC400	0-40	700 ⁽²⁾	561	700 ⁽²⁾	561 ⁽¹⁾	700 ⁽²⁾	561	700 ⁽¹⁾	561 ⁽¹⁾
SC200	0-40	343	171	343 ⁽¹⁾	171 ⁽¹⁾	343	171	343 ⁽¹⁾	171 ⁽¹⁾
SC401	0-40	700 ⁽²⁾	700 ⁽²⁾	700 ⁽²⁾	700 ⁽²⁾	700 ⁽²⁾	700 ⁽²⁾	700 ⁽¹⁾	700 ⁽¹⁾
SC400	0-60	700	374	747 ⁽¹⁾	374 ⁽¹⁾	747	374	700 ⁽¹⁾	374 ⁽¹⁾
SC200	0-60	226	113	226 ⁽¹⁾	113 ⁽¹⁾	228	114	228 ⁽¹⁾	114 ⁽¹⁾
SC401	0-60	700 ⁽²⁾	700 ⁽²⁾	700 ⁽²⁾	700 ⁽²⁾	700 ⁽²⁾	700	700 ⁽¹⁾	700 ⁽¹⁾
SC400	0-80	543	271	543 ⁽¹⁾	271 ⁽¹⁾	560	280	560 ⁽¹⁾	280 ⁽¹⁾
SC200	0-80	164	82	134	82 ⁽¹⁾	170	85	134	84
SC401	0-80	700 ⁽²⁾	700	700 ⁽²⁾	700 ⁽¹⁾	700 ⁽²⁾	700	700 ⁽¹⁾	700 ⁽¹⁾
SC400	1-00	419	210	419 ⁽¹⁾	210 ⁽¹⁾	447	223	447 ⁽¹⁾	223 ⁽¹⁾
SC200	1-00	126	63	85	53	136	68	85	53
SC401	1-00	700 ⁽²⁾	548	700 ⁽²⁾	548 ⁽¹⁾	700 ⁽²⁾	582	700 ⁽¹⁾	582 ⁽¹⁾
SC400	1-20	336	168	336 ⁽¹⁾	168 ⁽¹⁾	371	186	371 ⁽¹⁾	186 ⁽¹⁾
SC200	1-20	101	50	58	36	113	56	58	36
SC401	1-20	700 ⁽²⁾	440	700 ⁽²⁾	440 ⁽¹⁾	700	484	700 ⁽¹⁾	484 ⁽¹⁾
SC400	1-40	275	138	271	138 ⁽¹⁾	317	159	271	159 ⁽¹⁾
SC200	1-40	83	41	42	26	96	48	42	26
SC401	1-40	700	361	700 ⁽¹⁾	361 ⁽¹⁾	700	414	700 ⁽¹⁾	414 ⁽¹⁾
SC400	1-60	230	115	206	115 ⁽¹⁾	277	139	206	129
SC200	1-60	69	35	31	19	83	42	31	19
SC401	1-60	604	302	604 ⁽¹⁾	302 ⁽¹⁾	700	362	700 ⁽¹⁾	362 ⁽¹⁾
SC400	1-80	194	97	162	97 ⁽¹⁾	245	123	162	101
SC200	1-80	59	29	23	15	73	37	23	15
SC401	1-80	510	255	510 ⁽¹⁾	255 ⁽¹⁾	641	321	641 ⁽¹⁾	321 ⁽¹⁾
SC400	2-00	165	83	130	81	220	110	130	81
SC200	2-00	51	25	18	11	66	33	18	11
SC401	2-00	434	217	434 ⁽¹⁾	217 ⁽¹⁾	575	288	575 ⁽¹⁾	288 ⁽¹⁾
SC400	2-20	142	71	106	66	199	100	106	66
SC200	2-20	44	22	14	9	59	29	14	9
SC401	2-20	371	186	371 ⁽¹⁾	186 ⁽¹⁾	521	261	521 ⁽¹⁾	261 ⁽¹⁾
SC400	2-40	123	61	87	55	182	91	87	55
SC200	2-40	38	19	11	7	53	27	11	7
SC401	2-40	319	160	319 ⁽¹⁾	160 ⁽¹⁾	476	238	460	238 ⁽¹⁾
SC400	2-60	107	53	73	46	167	83	73	46
SC200	2-60	33	17	8	5	49	24	8	5
SC401	2-60	276	138	276 ⁽¹⁾	138 ⁽¹⁾	436	219	389	219 ⁽¹⁾
SC400	2-80	94	47	61	38	154	77	61	38
SC200	2-80	29	15	6	4	45	22	6	4
SC401	2-80	240	120	240 ⁽¹⁾	120 ⁽¹⁾	405	202	333	202 ⁽¹⁾
SC400	3-00	82	41	52	33	143	71	52	33
SC200	3-00	25	13	4	3	41	21	4	3
SC401	3-00	209	105	209 ⁽¹⁾	105 ⁽¹⁾	376	188	286	179

Column loads

Section	Maximum axial column load ⁽⁴⁾	
	Column height (m)	(kgf)
SC400	0-20	6325
SC200	0-20	4279
SC401	0-20	11475
SC400	0-40	6217
SC200	0-40	3850
SC401	0-40	11375
SC400	0-60	5982
SC200	0-60	2879
SC401	0-60	11041
SC400	0-80	5640
SC200	0-80	1867
SC401	0-80	10621
SC400	1-00	5102
SC200	1-00	1253
SC401	1-00	10035
SC400	1-20	4346
SC200	1-20	891
SC401	1-20	9193
SC400	1-40	3549
SC200	1-40	664
SC401	1-40	8088
SC400	1-60	2872
SC200	1-60	513
SC401	1-60	6889
SC400	1-80	2345
SC200	1-80	408
SC401	1-80	5792
SC400	2-00	1938
SC200	2-00	332 ⁽³⁾
SC401	2-00	4874
SC400	2-20	1625
SC200	2-20	276 ⁽³⁾
SC401	2-20	4131
SC400	2-40	1381
SC200	2-40	233 ⁽³⁾
SC401	2-40	3534
SC400	2-60	1186
SC200	2-60	199 ⁽³⁾
SC401	2-60	3051
SC400	2-80	1030
SC200	2-80	172 ⁽³⁾
SC401	2-80	2658
SC400	3-00	902
SC200	3-00	150 ⁽³⁾
SC401	3-00	2335

Note to tables

(1) Based on a limited deflection of $\frac{L}{200}$, the safe maximum load value is given which will give a deflection of $\leq \frac{L}{200}$

(2) Limited by slip on a single bolt connection each end

(3) For columns, the limiting slenderness ratio of 180 is exceeded at the length indicated

(4) It should be noted that maximum axial column loads are supplied for guidance only. It is unlikely that columns will be loaded with axial load only. Most practical load conditions will involve the use of brackets and fittings attached to the column. Loads applied in this way will produce both axial load and bending on the columns which will reduce the allowable maximum load

The above loads have been treated as imposed loads in accordance with BS 5950 Part 5 and accordingly a load factor of $f = 1.6$ has been assumed. Should the loads to be applied be of a permanent nature it may be appropriate to use a load factor of $f = 1.4$. This would lead to an increase in the load capacity provided that capacity is not limited by bolt slip or deflection

Loads given in the chart are for pre-galvanised channels to BS EN 10346 grade S250GD Z275. The process of manufacturing channel increases the strength of the steel and this increase has been allowed for in the data (as recommended in BS 5950 Part 5). However, if channels are subsequently hot dip galvanised the stresses created during manufacture are relieved by the heat of the process, thereby negating the strength enhancement. Therefore for hot dip galvanised channels the loads in the chart should be reduced by between 10% and 20% depending on the section. A 20% reduction will provide a conservative maximum load value for all types of hot dip galvanised channel

All loads are for brackets fixed with M12 setscrews and M12 zinc plated channel nuts

Packaging, handling, storage and safety

IN THIS SECTION...

- Export packaging
- Handling and storage
- Safety during installation phase

Export packaging

Safe handling

All Legrand products can be supplied packed appropriately for any mode of shipment.

The various packing options are illustrated below.

Further details and packing recommendations are available from Legrand, contact us on +44 (0) 345 605 4333.

Even when appropriately packed it is most important that equipment is correctly loaded.

All equipment must be properly secured against movement during transit otherwise damage may occur during the journey.

Containerised seafreight

Straight lengths

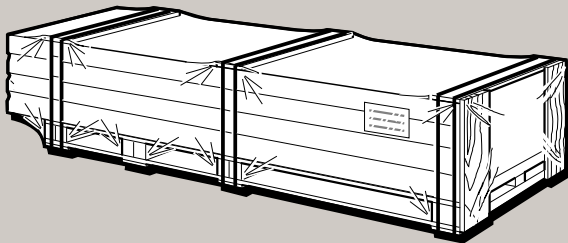

- The specially designed wooden framework enables lifting of the pallet by fork lift vehicle from either side or one end only. It is also designed to prevent insertion of the forks between components which will cause damage.
- Equipment is steel strapped to the wooden framework. If required the complete assembly is shrink wrapped in heavy duty polythene.
- Shipping marks are applied to meet with contract requirements.

Cable tray and support system accessories

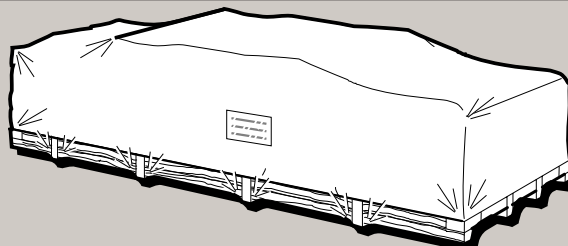

- The specially designed wooden framework enables lifting of the pallet by fork lift vehicle from either side or one end only. It is also designed to prevent insertion of the forks between components which will cause damage.
- Equipment is steel strapped to the wooden framework. The complete assembly is shrink wrapped in heavy duty polythene.
- Shipping marks are applied to meet with contract requirements.

Non-containerised seafreight, road or airfreight

Straight lengths



Equipment is steel strapped onto a wooden base.

If required the complete assembly is shrink wrapped in heavy duty polythene.

Shipping marks are applied to meet with contract requirements.

Specialised packing

Legrand can also supply equipment packed in wooden crates or wooden cases for shipment to destinations where transhipment or rough handling en route is likely or where transport over rough terrain is anticipated.

Wooden casing

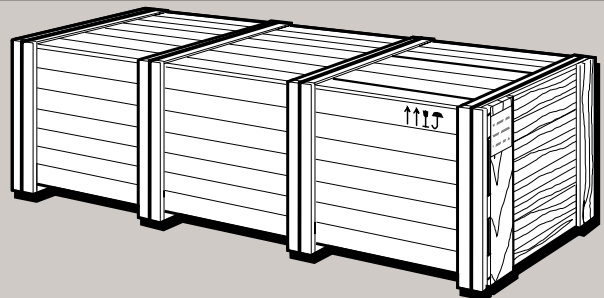

Equipment is steel strapped in suitable stacks.

Stacks are then tightly packed within a case constructed from close wooden boards with no gaps.

Wooden crating

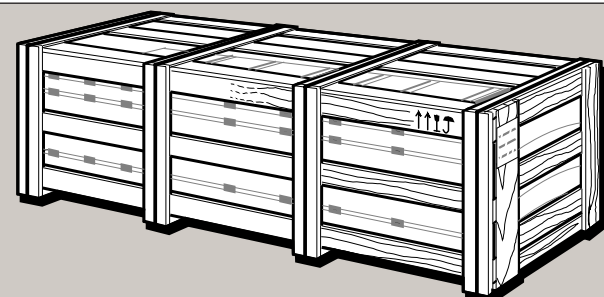

Equipment is steel strapped in suitable stacks.

Each stack is then shrink wrapped in heavy duty polythene. Stacks are then tightly packed within a wooden crate.

Handling and storage

Safe handling

Site deliveries will only be made provided suitable mechanical handling equipment is available on site.

The delivered material must be treated with care. Lifting must only be carried out from the sides and lifting forks must pass below a complete stack. Forks must never be inserted into the end of the stack (unless goods are packed in special containerisation crates, see Export Packaging on page 144); this practice is likely to cause the safety limits of most lifting vehicles to be exceeded and will certainly cause damage to the equipment being lifted.

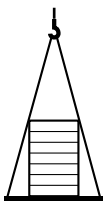

For offloading by crane suitable lifting beams should be inserted from side to side beneath a stack and these must be sufficiently long to avoid undue pressure on the edges of the bottom components.



The tensioned banding used for securing bundles of equipment during transport is not suitable for lifting purposes. When cutting this banding appropriate eye protection must be worn to avoid injury.



Sheared steel (particularly pre-galvanised or stainless steel) does have relatively sharp edges and protective gloves must be worn during handling.

Storage

Most support equipment is supplied with a corrosion resistant finish (often hot dip galvanising) which will, once the equipment is erected and open to the air, have a service life of many years. However if hot dip galvanised equipment is allowed to become wet whilst stacked awaiting installation the finish can quickly suffer from unsightly staining and powdering on the surface. This is known as Wet storage stain (see below) and the effects are particularly exaggerated if products are left in back to back contact.

It is therefore essential that all support system equipment is stored in a dry, unheated environment and that the following precautions are observed to prevent deterioration on site :

- Any outer packaging should be removed from stacks immediately following delivery, before the goods are placed in store.
- Store all support equipment under cover, in dry, unheated premises. Do not leave any uncovered, part-used stacks lying outside for long periods.
- If stacks of equipment have become wet they must be re-stacked as soon as possible with wooden battens inserted between components to allow air to circulate.
- If no undercover storage is available then equipment should be re-stacked as in (c) immediately following delivery and a simple shelter, using polythene or a tarpaulin, should be erected over the stored equipment to protect it from rain. This covering should not be laid directly onto the stack as air must be allowed to circulate through and around the stored goods.
- Inspect stored goods regularly to ensure that moisture has not penetrated into the stacks.
- Do not store the delivered material where people will walk across it.

Wet storage stain

Failure to comply with the above storage conditions may result in galvanised material being quickly disfigured by Wet storage stain. Fortunately this problem is rarely serious and (unless the poor storage conditions have continued unchecked for several months) it has no significant effect on the long term corrosion resistance of the finish. Where equipment has been affected by Wet storage stain the unsightly marking will usually become much less prominent and will often disappear completely within months of installation.

Safety during installation phase

Site safety

Heavy duty cable trays are designed for rugged conditions and can withstand some abuse. However they are not designed or intended for use as walkways or scaffolds and proper working platforms or temporary access scaffolding must be provided for the use of installation personnel.

Control of hazardous substances



Legrand cable management support systems will have a surface coating of either zinc, light oil or a plastic material, depending upon the specified finish.



If any welding of equipment is carried out these substances can give rise to fumes and so appropriate ventilation must be provided to ensure the exposure of the operator is kept below the statutory limits.



The current occupational exposure limits for zinc oxide fumes published by the U.K. Health & Safety Executive are 10mg/m³ for short term exposure and 5mg/m³ for long term exposure.

Relevant British, European and International standards

Standard Type	BS No	Part	Title
BS	1140	0	Specification for resistance spot welding of uncoated and coated low carbon steel.
BS EN	1179	0	Zinc and zinc alloys. Primary zinc.
BS EN ISO	1461	0	Hot dip galvanised coatings on fabricated iron and steel articles – specifications and test methods.
BS	7371	3	Coatings on metal fasteners. Specification for electroplated zinc coatings
BS EN ISO	2081	0	Metallic and other inorganic coatings. Electroplated coatings of zinc with supplementary treatments on iron or steel
BS EN ISO	3506	1	Mechanical properties of corrosion resistant stainless steel fasteners. Part 1, Bolts, Screws and Studs.
BS EN ISO	3506	2	Mechanical properties of corrosion resistant stainless steel fasteners. Part 2 Nuts.
BS	3692	0	ISO metric precision hexagon bolts, screws and nuts. Specification.
BS	4320	0	Specification for metal washers for general engineering purposes. Metric series.
BS	4872	1	Specification for approval testing of welders when welding procedure approval is not required. Fusion welding of steel.
BS	5950	5	Structural use of steelwork in building.
BS	6338	0	Chromate conversion coatings on electroplated zinc and cadmium coatings.
PD	6484	0	Commentary on corrosion at bimetallic contacts and its alleviation.
BS	6946	0	Specification for metal channel cable support systems for electrical installations.

Standard Type	BS No	Part	Title
BS	7671	0	Requirements for electrical installations. IEE Wiring Regulations. Seventeenth Edition.
BS EN ISO	9000		Quality management systems - fundamentals and vocabulary.
BS EN ISO	9001		Quality management systems - requirements.
BS EN ISO	9004		Quality management systems - guidelines for performance improvements.
BS EN	10025	2	Hot rolled products of structural steels. Technical delivery conditions for non alloy structural steels.
BS EN	10025	5	Hot rolled products of structural steels. Technical delivery conditions for structural steels with improved atmospheric corrosion resistance.
BS EN	10088	1	Stainless steels. Part 1: List of stainless steels.
BS EN	10088	2	Stainless steels. Part 2: Technical delivery conditions for steel sheet/plate and strip of corrosion resisting steels for general purposes.
BS EN	10088	3	Stainless steels. Part 3: Technical delivery conditions for semi-finished products, bars, rods, wire, sections and bright products of corrosion resisting steels for general purposes.
BS EN	10346	0	Continuously hot-dip coated steel flat products. Technical delivery conditions.
BS EN ISO	12944	5	Paints and varnishes - Corrosion protection of steel structures by protective paint systems. Part Protective paint systems.
BS EN ISO	14713	1	Zinc coatings. Guidelines and recommendations for the protection against corrosion of iron and steel in structures. General principles of design and corrosion resistance.
BS EN ISO	14713	2	Hot dip galvanising. Guidelines and recommendations for the protection against corrosion of iron and steel in structures. General principles of design and corrosion resistance.
IEC	61537	0	Cable Tray systems and cable ladder systems for cable management.
BS EN	1991	1.3	Eurocode 1 : Action on structures. General actions : snow loads
BS EN	1991	1.4	Eurocode 1 : Action on structures. General actions : wind loads
BS EN	1993	1.3	Eurocode 3 : Design of steel structures. General rules. Supplementary rules for cold-formed members and sheeting.

Cat. Nos.	Page No.	Cat. Nos.	Page No.	Cat. Nos.	Page No.	Cat. Nos.	Page No.	Cat. Nos.	Page No.	Cat. Nos.	Page No.
C		MRFL900F	18	SA764	29	SC4033M	28	SS1040	32	XRFL100F	22
		MRFORWAF	19	SA765	-	SC4036M	-	SS1045	-	XRFL150F	-
CKP25	25	MRFORWF	-	SA766	-	SC4103M	-	SS1050	-	XRFL225F	-
CKP50	-	MRFRWKF	-	SA770	-	SC4133M	-	SS1060	-	XRFL300F	-
CP1035	32	MRFTCCWF	26	SA771	-	SC850	31	SS1220	-	XRFL450F	-
CP1035S	-	MRFTCVWF	-	SA772	-	SC851	-	SS1225	-	XRFL600F	-
		MRFTWF	19	SA773	-	SC852/21	-	SS1230	-	XRFORWAF	23
E		MRFUBF	24	SA774	-	SC852/41	-	SS1235	-	XRFORWF	-
EB06	33	MRFUTWBF	19	SA775	-	SC852/82	-	SS1240	-	XRFWRWKF	-
EB08	-	MRFXWF	-	SA776	-	SC853	-	SS1250	-	XRFCCWF	26
EB10	-			SA790	-	SC854	-	SSARWF	17	XRFCCVWF	-
		O		SA791	-	SC855	-	SSBWAF	16	XRFTWF	23
		OH50F	25	SA792	-	SC856	-	SSBWF	-	XRFUTWBF	-
		OH75F	-	SA793	-	SC950B	-	SSCCWF	26	XRFVCWF	26
		OH100F	-	SA794	-	SC950W	-	SSCVWF	-	XRFXWF	23
		OH150F	-	SA795	-	SC951B	-	SSDVF	-		
F				SA796	-	SC951W	-	SSG0612	32	Z	
FF	24			SB500	30	SC952	-	SSG0616	-	ZC1	31
FL2	31			SB501	-	SC953	-	SSG0620	-		
FW06	33			SB502	-	SCLG	18	SSG0635	-		
FW08	-			SB503	-	SCLPG	-	SSIRWAF	16		
FW10	-	P		SB504	-	SGR	-	SSIRWF	-		
FW12	-	PN060	28	SB505	-	SP960	31	SSL50F	-		
		PN061	-	SB50606	-	SP964	-	SSL75F	-		
		PN062	-	SB50608	-	SP965	-	SSL100F	-		
H		PN080	-	SB50610	-	SP968	-	SSL150F	-		
HN06	32	PN081	-	SB50612	-	SP969	-	SSL225F	-		
HN08	-	PN082	-	SB507	-	SP972	-	SSL300F	-		
HN10	-	PN100	-	SB508	-	SP973	-	SSORWAF	17		
HN12	-	PN101	-	SB509	-	SP975	-	SSORWF	-		
		PN102	-	SB510	-	SP976	-	SSRWKF	-		
L		PN120	-	SB511	-	SRFABWF	21	SSTCCWF	26		
LCA50F	25	PN122	-	SB513	-	SRFARWF	-	SSTCVWF	-		
LCA75F	-	PTFEB	26	SB514	-	SRFAXRWF	-	SSTWF	17		
LCA100F	-	PW06	33	SB515	-	SRFBWAF	-	SSXWF	-		
LCA150F	-	PW08	-	SB518	31	SRFBWF	-	STB50F	25		
LCA225F	-	PW10	-	SB520	30	SRFCCWF	26	STB75F	-		
LCA300F	-	PW12	-	SB524	-	SRFCF	20	STB100F	-		
LCA450F	-			SB526	-	SRFCVWF	26	STB150F	-		
LCA600F	-	Q		SB528	-	SRDVF	-	STB225F	-		
LCA750F	-	QBF	18	SB532	-	SRFIRWAF	21	STB300F	-		
LCA900F	-	QBFS	-	SB534	-	SRFIRWF	-	STB450F	-		
LTH50F	25			SB536	-	SRFL75F	20	STB600F	-		
LTH75F	-	R		SB550	-	SRFL100F	-	STB750F	-		
LTH100F	-	RB0612	27	SB551	-	SRFL150F	-	STB900F	-		
LTH150F	-	RB0612S	-	SB552	-	SRFL225F	-	SW06	33		
LTH225F	-	RB0616	-	SB554	-	SRFL300F	-	SW08	-		
LTH300F	-	RB0616S	-	SB555	-	SRFL450F	-	SW10	-		
LTH450F	-	RB0620	-	SB556	-	SRFL600F	-	SW12	-		
LTH600F	-	RB0620S	-	SB600	31	SRFL750F	-				
LTH750F	-	RB0625	-	SB601	-	SRFL900F	-	T			
LTH900F	-	RB0630	-	SB602	-	SRFMRFWF	21	TR06	27		
		RB0640	-	SB603	30	SRFORWAF	-	TR08	-		
M		RB0650	-	SB603+	-	SRFORWF	-	TR10	-		
MFF	24	RBG0612	-	SB606	-	SRFRWKF	-	TR12	-		
MRFABWF	19	RBG0616	-	SB607	-	SRFTCCWF	26	TW06	-		
MRFARWF	-	RC06	-	SB650	31	SRFTCVWF	-	TWG06	-		
MRFAXRWF	-	RC08	-	SB651	-	SRFTWF	21				
MRFBWAF	-	RC10	-	SB700	-	SRFUBF	24				
MRFBWF	-	RC12	-	SB701	-	SRFUTWBF	21				
MRFCCWF	26	RWG06	-	SB702	-	SRFXWF	-	U			
MRFCF	18			SB703	-	SS0616	32	UF450F	24		
MRFC50F	-			SB704	-	SS0620	-				
MRFCVWF	26			SB705	-	SS0625	-	W			
MRFDFV	-			SB706	-	SS0630	-	WFF	24		
MRFIRWAF	19			SB707	-	SS0820	-				
MRFIRWF	-			SC2003M	28	SS0825	-				
MRFL50F	18			SC2006M	-	SS0830	-				
MRFL75F	-			SC2033M	-	SS0835	-				
MRFL100F	-			SC2036M	-	SS0840	-				
MRFL150F	-			SC2103M	-	SS0850	-	XRFBWAF	22		
MRFL225F	-			SC2133M	-	SS1016	-	XRFBWF	-		
MRFL300F	-			SC4003M	-	SS1020	-	XRFCCWF	26		
MRFL450F	-			SC4006M	-	SS1025	-	XRFCF	22		
MRFL600F	-			SC4013M	-	SS1030	-	XRFDFV	26		
MRFL750F	-			SC4016M	-	SS1035	-	XRFIRWAF	23		
								XRFIRWF	-		

Contact details

United Kingdom

Great King Street North,
Birmingham, B19 2LF

Customer Services:

Tel: +44 (0) 345 605 4333 Fax: +44 (0) 345 605 4334
E-mail: legrand.sales@legrand.co.uk

Quotations and Technical Support:

Tel: +44 (0) 370 608 9020 Fax: +44 (0) 345 605 5334
E-mail: uk-cmsales@legrand.co.uk

Republic of Ireland:

Tel: 01 295 9673 Fax: 01 295 4671
E-mail: legrand.sales@legrand.co.uk

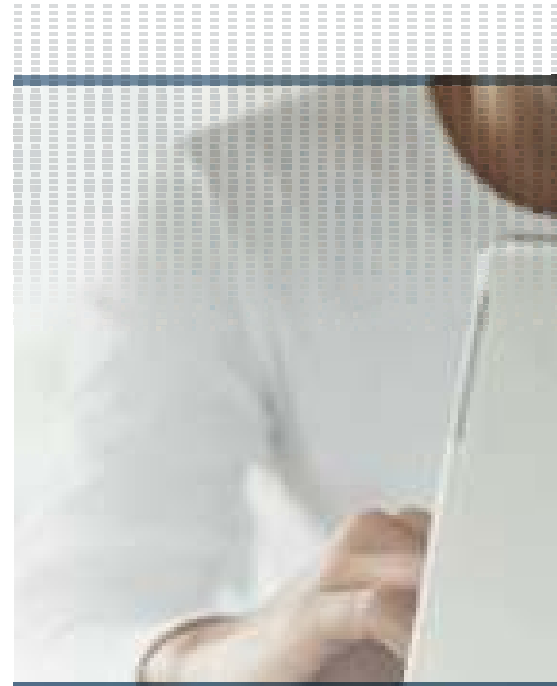

FOLLOW
US AT

@ www.legrand.co.uk
www.legrand.ie

 www.youtube.com/legrandtvuk

 www.twitter.com/legranduk

 www.votimum.co.uk
www.votimum.ie

Distributor:



Head office (UK and Ireland):
Legrand Electric Limited
Great King Street North, Birmingham, B19 2LF
Tel: +44 (0) 370 608 9000 Fax: +44 (0) 370 608 9004
www.legrand.co.uk



This document is printed on sustainably sourced paper. Please recycle.

The Legrand logo is a registered trademark
of the Legrand group of companies.