



Changes for the Better

PASSENGER ELEVATORS



NEXIEZ-S

Modern & Fun

The name says it all. An affordable standard elevator that is stylish, safe and incorporates advanced technologies that ensure smart operation that saves energy every day.

No wonder our new compact elevator joins the NEXIEZ-Series.

The elevator's simple design complements virtually all architectural styles, and the selection of colors available is equally impressive. Additionally, enjoy excellent cost savings, speedy delivery, and the unwavering safety inherent of Mitsubishi Electric elevators.

Enjoy a safe, stylish and smart lifestyle with NEXIEZ-S.



reddot award 2017
winner

Principle

Based on our policy, "Quality in Motion", we provide elevators and escalators that will satisfy our customers with high levels of comfort, efficiency, ecology and safety.



Mitsubishi Electric elevators, escalators and building management systems are always evolving, helping achieve our goal of being the No.1 brand in quality. In order to satisfy customers in all aspects of comfort, efficiency and safety while realizing a sustainable society, quality must be of the highest level in all products and business activities, while priority is placed on consideration for the environment. As the times change, Mitsubishi Electric promises to utilize the collective strengths of its advanced and environmental technologies to offer its customers safe and reliable products while contributing to society.

We strive to be green in all of our business activities.

We take every action to reduce environmental burden during each process of our elevators' and escalators' lifecycle.



Contents

Space-saving	5
Safety and Comfort	6
Car Designs	7
Hall Designs	12
EN81-70 Compliance	13
Materials and Colors	14
Basic Specifications	15
Features	17
Important Information on Elevator Planning	18



Space-saving

Machine-room-less Elevators

As all equipment is installed within the hoistway, there are fewer restrictions on building design except for the actual space required for the hoistway. Architects and interior designers have more design freedom.

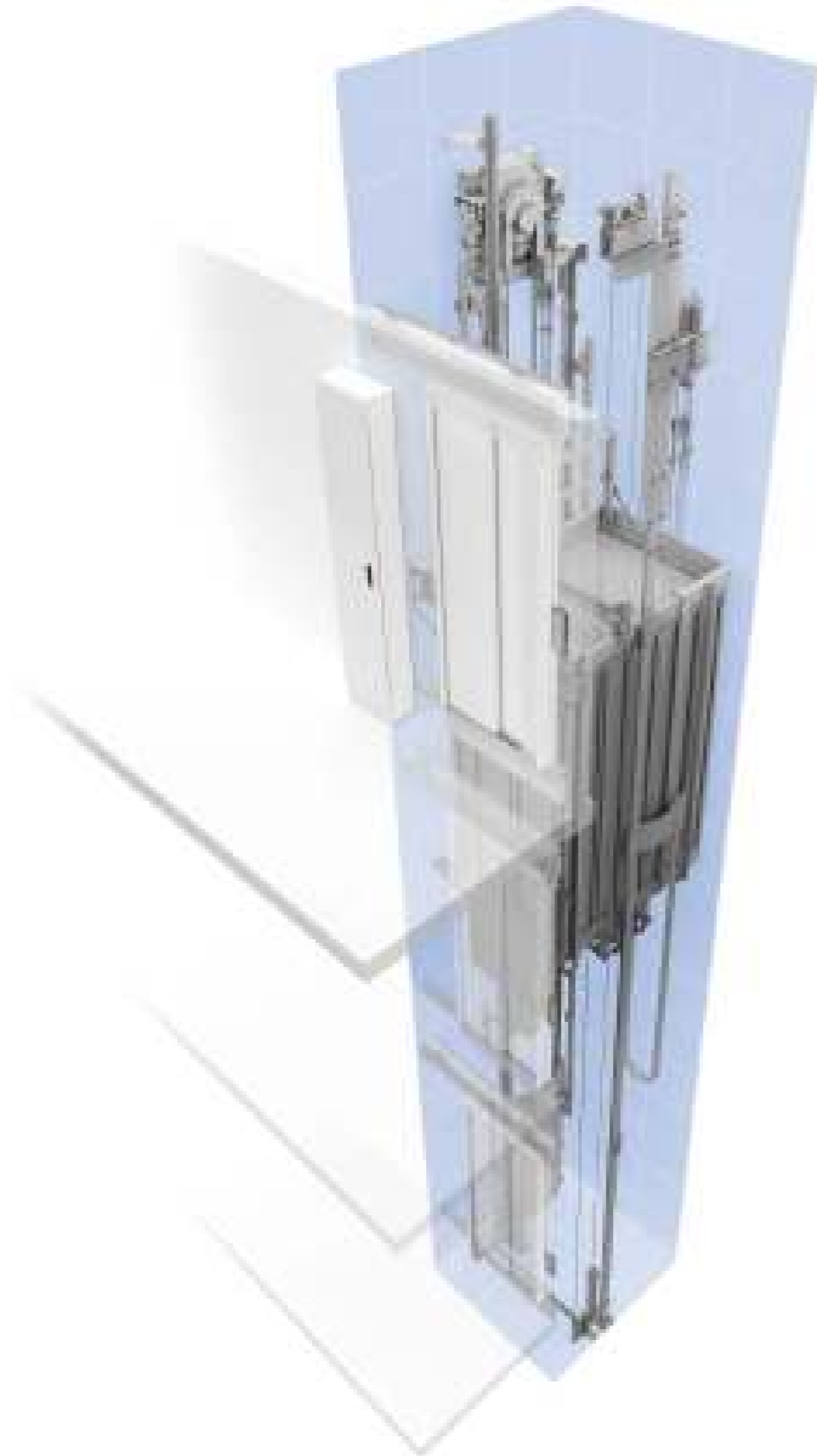

Safety and Comfort

Features to help everyone travel safely and comfortably

Click-type Hall Call Button with Hall Lantern Function: HBEHL *1

When the car is about to arrive at a floor, the hall button flashes to inform passengers of car arrival.

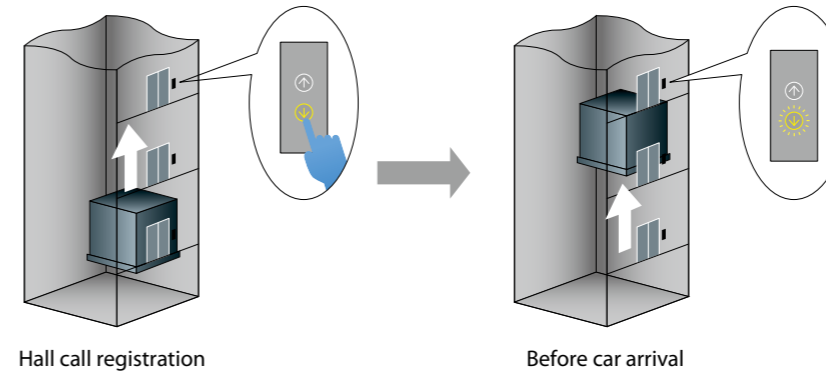

Safety Ray: SR *2

An infrared-light beam covers the full width of the doors to detect passengers or objects as the doors close.



Multi-beam Door Sensor (Optional)*2

Multiple infrared-light beams cover some height of the doors to detect passengers or objects as the doors close.



Mitsubishi Emergency Landing Device: MELD (Optional)

Upon power failure, the car automatically moves to the nearest floor using a rechargeable battery to facilitate the safe evacuation of passengers.

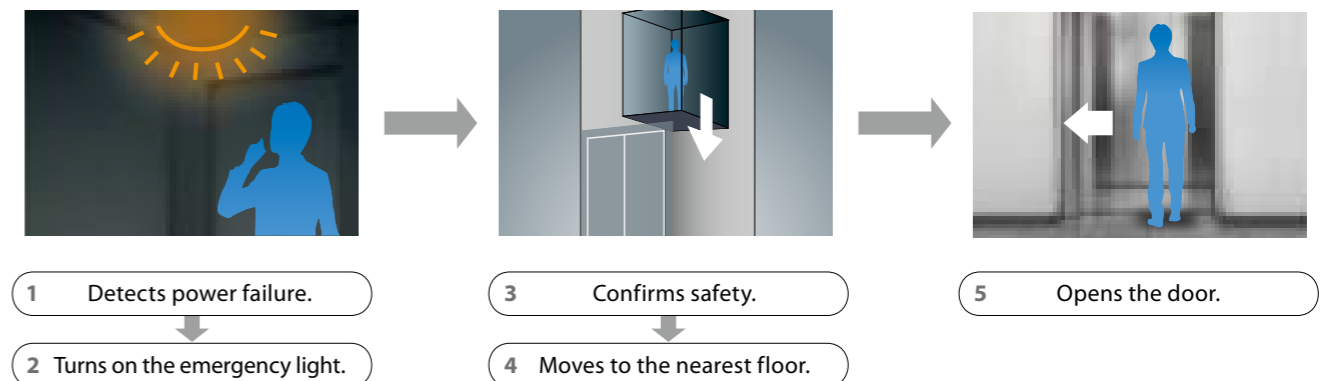

Notes:

*1: The HBEHL feature is provided to the hall buttons (without indicator).

*2: The application differs depending on regulation. See page 17 for details.

Car Designs

N700 Standard

Simple yet stylish car designs attractively compliment any interior, providing easy coordination and freedom of application to almost any building design.



Standard Car Design

- Ceiling ————— N700: Painted steel sheet (Y033: white)
- Side walls ————— Stainless-steel, hairline-finish
- Rear wall ————— Stainless-steel, hairline-finish
- Front return panel ——— Stainless-steel, hairline-finish
- Flooring ————— Durable vinyl tiles (PR801: cream beige)

L700

White downlight design utilized to create new elevator car interior look with elegant lighting atmosphere and sophisticated appearance.



Car Design Example

- Ceiling ————— L700: Painted steel sheet (Y055: dark gray)
- Side walls ————— Painted steel sheet (Y014: red-violet)
- Rear wall ————— Stainless-steel, hairline-finish
- Front return panel ——— Stainless-steel, hairline-finish
- Flooring ————— Durable vinyl tiles (PR812: dim-gray)

Car Designs



Color Variations

The feeling of spaciousness created by a wide range of wall color variations is complemented by new lighting fixtures that produce an elegant, comfortable car atmosphere.

Car Walls

Side and rear walls: stainless-steel, hairline-finish

Stainless-steel



Car Front (Doors, Transom Panel and Front Return Panel)

Stainless-steel, hairline-finish

Doors with window (W: 200 x H: 1300)*

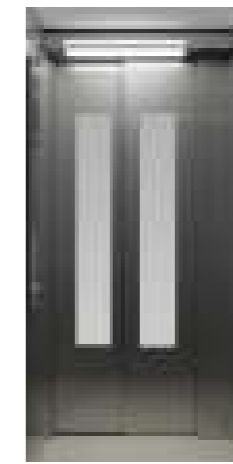
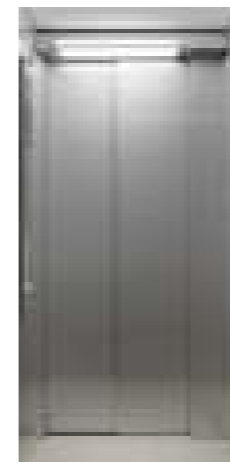

* Applicable only when the entrance width (JJ) is 800mm, but not comply with EN81-1.

Combination wall

Side walls: painted steel
Rear wall: stainless-steel, hairline-finish



Side walls: laminated steel
Rear wall: stainless-steel, hairline-finish



Color walls

Side and rear walls: painted steel

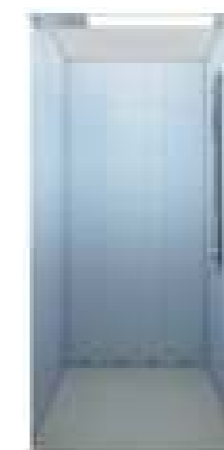

Side and rear walls: laminated steel

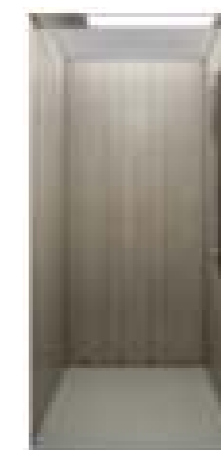

Side wall colors

Y014
Red-violet

Y116
Blue

Y033
White

Y119
Carrot orange

Y117
Lime green

Y118
Light grayish blue

LA03
Washed Oak

LA02
Oiled Walnut

Car Designs

Car Operating Panels

Segment LED indicators *



Standard
CBV1-M760
(without intercom
or AAN feature)

Side view



CBV1-M760
(with intercom
and/or AAN feature)



CBV1-M762
(for EN81-70)

Handrail and Mirror

Handrail



YH-59S
(Stainless-steel, hairline-finish)

Mirror

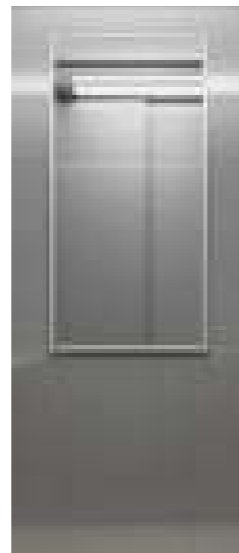

YZ-52AN

Note:
* Segment LED indicators cannot display some letters of alphabet. Please consult our local agents for details.

Hall Designs



Doors with window *1
(W: 200 x H: 1300)



Standard

Jamb (E-102) — Stainless-steel, hairline-finish
Doors — Stainless-steel, hairline-finish
Hall button — HBV1-A910N

Hall Design Example

Jamb (E-102) — Painted steel sheet (Y033: White)
Doors — Painted steel sheet (Y033: White)
Hall position indicator
and button — PIV1-A910N

Hall Buttons

Hall Position Indicators and Buttons

Segment LED indicators *2



Standard
HBV1-A910N
Boxless



HBV1-A910B
(with chime) *3



PIV1-A910N
Boxless



PIV1-A910B
(with chime) *3

Cross-section of boxless fixtures Boxless

These hall signal fixtures can be easily mounted on the wall surface without having to cut into the wall to embed the back box.



Notes:
*1: Applicable only when the entrance width (JJ) is 800mm, but not comply with EN81-1.
*2: Segment LED indicators cannot display some letters of alphabet. Please consult our local agents for details.
*3: Hall buttons with chime are required to comply with EN81-70 or to install AHC or AECH-B feature.

Actual colors may differ slightly from those shown.

EN81-70: 2003 Compliance



This EN81-70 compliant package is only for an elevator for six persons.

Car



Hall

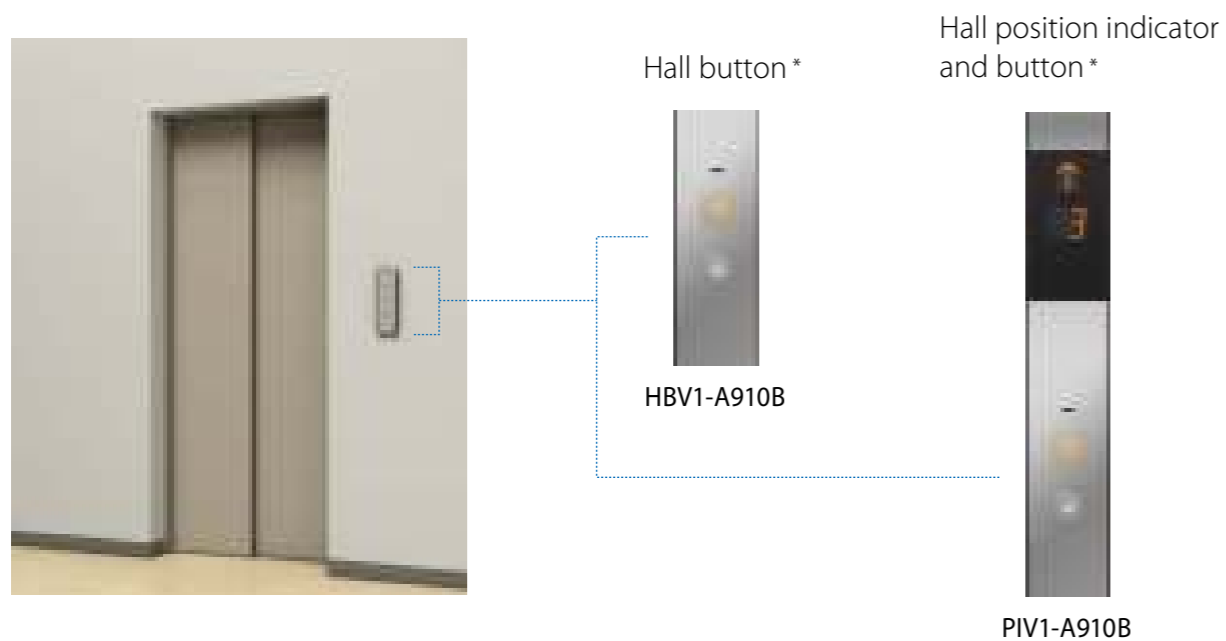

Note:
* A slit is provided for audible signals to comply with EN81-70.

Materials and Colors

Car

Ceiling

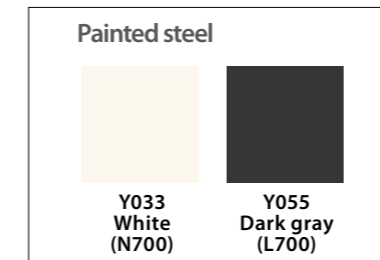

Walls

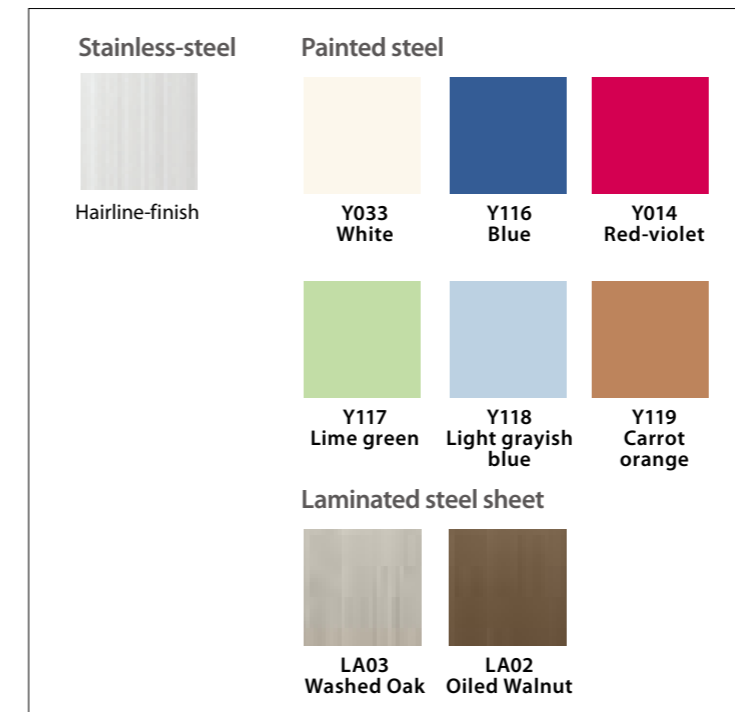

Transom panel, front return panel and doors

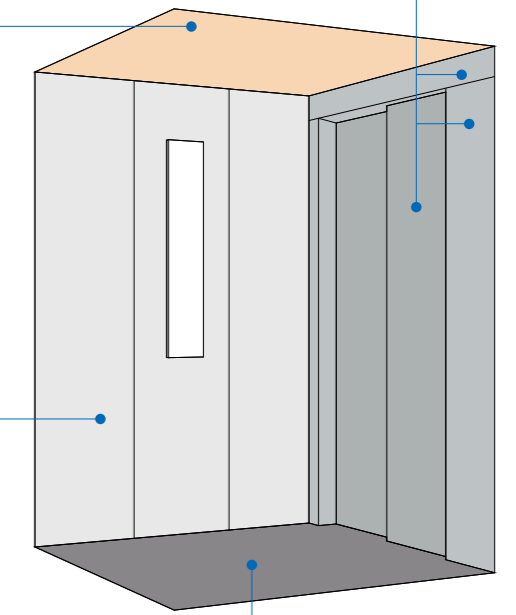

Flooring



Hall

Jamb and doors

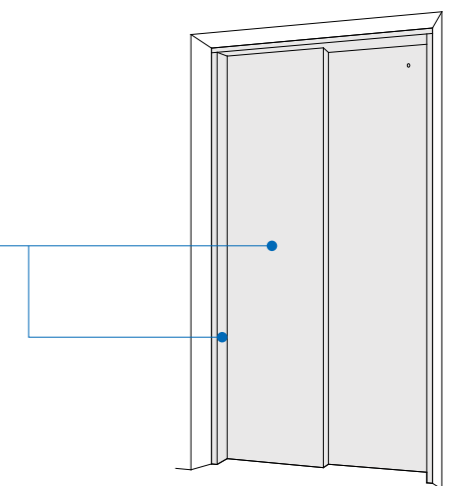
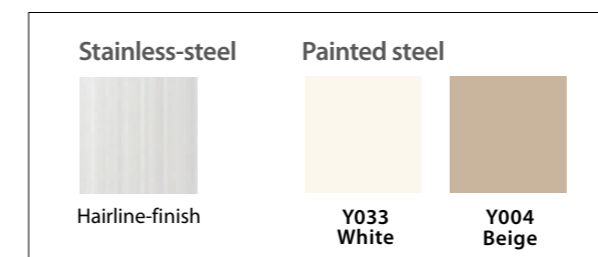

Actual colors may differ slightly from those shown.

Basic Specifications

Hoistway Plan

Hoistway Section

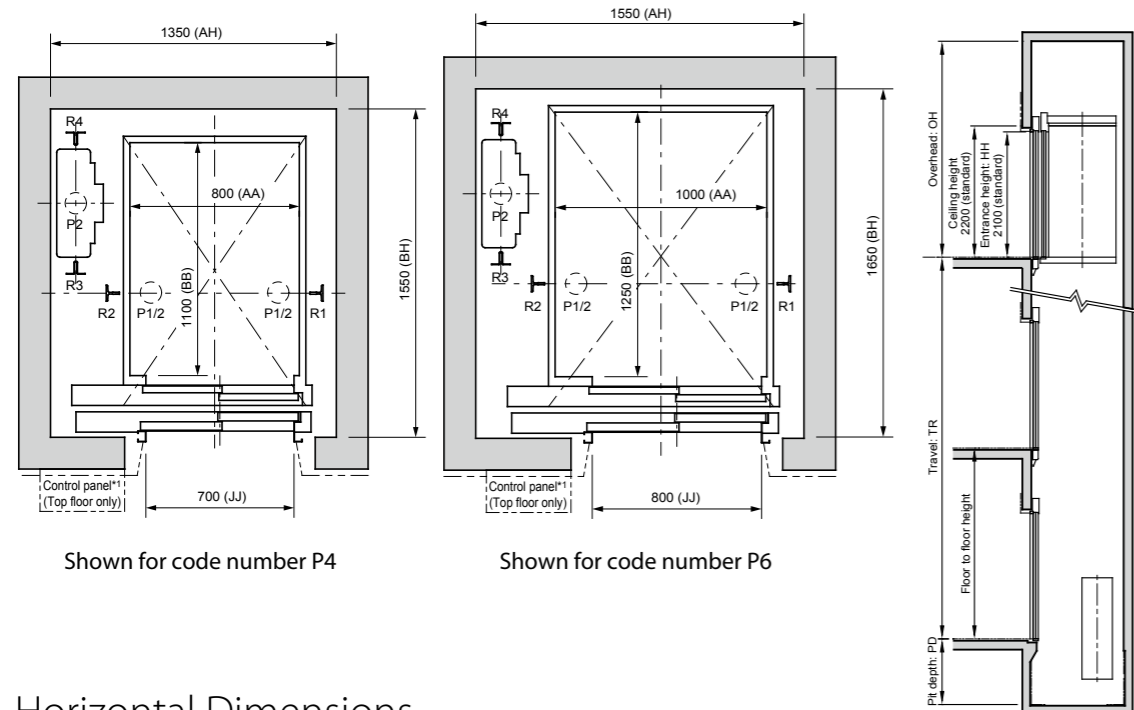

Entrance Layout

Door plan (section A-A)

Door elevation (section B-B)

Hoistway entrance

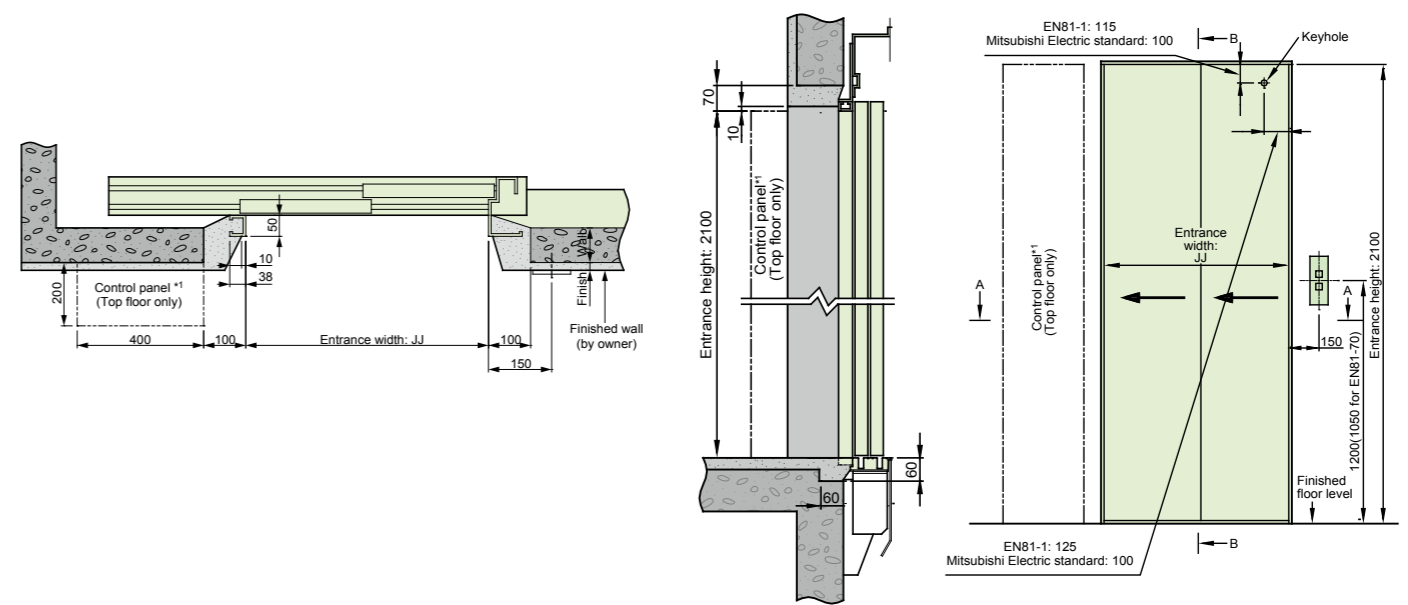

Horizontal Dimensions

Code number	Number of persons	Rated speed (m/sec)	Rated capacity (kg)	Door type	Entrance width (mm) JJ	Car internal dimensions (mm) AAxBB	Minimum hoistway dimensions (mm) AHxBH
P4	4	1.0	320	2S	700	800 x 1100	1350 x 1550
P6	6		450		800	1000 x 1250	1550 x 1650

- [Terms of the table]
- This table shows standard specifications without counterweight safety, regardless of whether fireproof landing doors are provide or not. Please consult our local agents for other specifications.
 - Rated capacity is calculated at 75kg per person, as required by EN81-1.
 - 2S: 2-panel side sliding doors.
 - Minimum hoistway dimensions (AH and BH) shown in the table are after waterproofing of the pit and do not include plumb tolerance.

Vertical Dimensions

Travel (m) TR	Maximum number of floors	Minimum overhead (mm) OH	Pit depth (mm) PD	Minimum floor to floor height (mm)
3 - 30	10	3500	1100*2 - 1500	2600

Reaction Loads

Number of persons	Rated capacity (kg)	Rated speed (m/sec)	Car internal dimensions (mm) AAxBB	Reaction loads (kN)					
				Rail				Buffer	
				R1	R2	R3	R4	P1	P2
4	320	1.0	800x1100	14	14	7	11	38	32
6	450		1000x1250	16	16	8	12	47	38

Applicable Standards

NEXIEZ-S complies with Mitsubishi Electric standard or EN81-1. For details on compliance, please consult our local agents.

- Notes:
- *1: Please consult our local agents for how to install the control panel.
 - *2: When a car finish flooring is supplied by the customer, the minimum pit depth shall be 1120mm. Please consult our local agents for details.

Power Feeder Data

Capacity (kg)	Rated speed (m/sec)	Motor output (kW)	Current at 400V			Capacity of power supply (kVA)	Heat emissions (W)
			FLU (A)	FLAcc (A)	Breaker in control panel (A)		
320	1.0	2	6	11	10	3	580
450		2.8	8	14	10	3	740

- FLU: current during upward operation with full load at a power supply voltage of 400V.
 FLAcc: current while accelerating with full load at a power supply voltage of 400V.
 Note: If power supply voltage (E) is a value other than 400V, FLU current and FLAcc current are obtained via the following formula.
 (FLU/FLAcc current (A) at E (V)) = (Current at 400V) × (400/E (V))

Feeder Size Calculation

- The feeder must be able to withstand continuous flow of the following current at an ambient temperature of 40°C.

$$FLU (A) \leq 50A \text{ ----- } 1.25 \times FLU (A)$$

(FLU (A): current during upward operation with full load at a power supply voltage of E (V))

The wire length for the feeder size must be calculated using the following formula.

$$\text{Wire length (m)} \leq \text{Coefficient} \times E (V) / FLAcc (A)$$

- (E: power supply voltage (V))
 (FLAcc (A): current while accelerating with full load at a power supply voltage of E (V))

* Refer to the table below for coefficients.

- The current size of the grounding wire is determined according to the current rating of the non-fuse (NF) breaker on the power source side.

- The current rating of the non-fuse (NF) breaker on the power source side should be one level larger than that on the control panel side.

Feeder size (mm ²)	3.5	5.5
Coefficient	6.3	9.7

EMERGENCY OPERATIONS AND FEATURES

Feature	Abbreviation	Mitsubishi Electric standard	EN81-1
Earthquake Emergency Return	EER-S	Optional	Optional
Fire Emergency Return	FER	Optional	Optional
Firefighters' Emergency Operation	FE	Optional	-
Mitsubishi Emergency Landing Device	MELD	Optional	Optional
Operation by Emergency Power Source --- Automatic	OEPS-SA	Optional	Optional

DOOR OPERATION FEATURES

Feature	Abbreviation	Mitsubishi Electric standard	EN81-1
Automatic Door Speed Control	DSAC	Standard	Standard
Door Load Detector	DLD	Standard	Standard
Door Nudging Feature --- With Buzzer	NDG	Standard	Standard
Door Sensor Self-diagnosis	DODA	Standard	Standard
Multi-beam Door Sensor	-	Optional	Standard
Reopen with Hall Button	ROHB	Standard	Standard
Repeated Door-close	RDC	Standard	Standard
Safety Door Edge	SDE	Optional	Optional
Safety Ray	SR	Standard	-

OPERATIONAL AND SERVICE FEATURES

Feature	Abbreviation	Mitsubishi Electric standard	EN81-1
Car Call Canceling	CCC	Standard	Standard
Car Fan Shut Off --- Automatic	CFO-A	Standard	Standard
Car Light Shut Off --- Automatic	CLO-A	Standard	Standard
False Call Canceling --- Car Button Type	FCC-P	Standard	Standard
Independent Service	IND	Standard	Standard
Next Landing	NXL	Standard	Standard
Non-service Temporary Release for Car Call --- Card Reader Type	NSCR-C *1	Optional	Optional
Out-of-service by Remote Control --- Hall	HOS *2	Optional	Optional
Overload Holding Stop	OLH	Standard	Standard
Safe Landing	SFL	Standard	Standard

SIGNAL AND DISPLAY FEATURES

Feature	Abbreviation	Mitsubishi Electric standard	EN81-1
Basic Announcement	AAN-B	Optional	Optional
Car Arrival Chime (Hall) --- Buzzer type	AECH-B	Optional	Optional *3
Car Call Button with Response Sound type	ACB	Optional	Optional *3
Click-type Hall Call Button with Hall Lantern Function	HBEHL *4	Standard	Standard
Emergency Bell	EMB	Standard	Optional
Emergency Car Lighting	ECL	Optional	Standard
Hall Call Button with Response Sound Type	AHC	Optional	Optional *3
Inter-communication System	ITP	Optional	Standard
Voice Guidance System	AAN-G	Optional	Optional *5

Notes:

*1: After card authentication, NSCR-C feature for NEXIEZ-S allows registration of a car call to all restricted floors but not to an individual floor.

*2: HOS feature is applicable when the number of stops is 8 or less.

*3: ACB, AHC and AECH-B features are required to comply with EN81-70.

*4: HBEHL feature does not function on the floors where hall position indicators and buttons are installed.

*5: AAN-G feature is required to comply with EN81-70.

Work Not Included in Elevator Contract

The following items are excluded from Mitsubishi Electric's elevator installation work. Their conditions and other details are to be conformed to the statement of local laws such as elevator codes or Mitsubishi Electric elevator's requirements on the responsibility of the building owner or general contractor.

- Architectural finishing of walls and floors in the vicinity of the entrance hall after installation has been completed.
- Construction of an illuminated, ventilated and waterproofed hoistway that conforms to Mitsubishi Electric's requirements.
- The provision of a ladder to the elevator pit if necessary.
- The provision of openings and supporting members as required for equipment installation.
- The provision of an emergency exit door and inspection door, when required, and access to the doors.
- All other work related to building construction.
- The provision of the main power and power for illumination in the hoistway by laying of the feeder wiring from the electrical switch boxes in electrical room into the hoistway.
- The provision of outlets and laying of the wiring in the hoistway, plus the power from the electrical switch box.
- The laying of conduits and wiring between the elevator pit and the terminating point for the devices installed outside the hoistway, such as the emergency bell, intercom and security devices.
- The power consumed in installation work and test operations.
- All the necessary building materials for grouting in of brackets, bolts, etc.
- The test provision and subsequent alteration as required, and eventual removal of the scaffolding as required by the elevator contractor, and any other protection of the work as may be required during the process.
- The provision of a suitable, locked space for the storage of elevator equipment and tools during elevator installation.
- The security system, such as a card reader, connected to Mitsubishi Electric's elevator controller, when supplied by the building owner or general contractor.

Note: Work responsibilities in installation and construction shall be determined according to local laws.

Elevator Site Requirements

- The temperature of the elevator hoistway shall be below 40°C.
- The following conditions are required for maintaining elevator performance.
 - a. The relative humidity shall be below 90% on a monthly average and below 95% on a daily average.
 - b. Prevention against icing and condensation occurring due to a rapid drop in the temperature shall be provided in the elevator hoistway.
 - c. The elevator hoistway shall be finished with mortar or other materials so as to prevent concrete dust.
- Voltage fluctuation shall be within a range of +5% to -10%.

Ordering Information

Please include the following information when ordering or requesting estimates:

- The desired number of units, speed and loading capacity
- The number of stops or number of floors to be served
- The total elevator travel and each floor-to-floor height
- Operation system
- Selected design and size of car
- Entrance design
- Signal equipment
- A sketch of the part of the building where the elevators are to be installed
- The voltage, number of phases and frequency of the power source for the motor and lighting



State-of-the-Art Factories... For the Environment. For Product Quality.

Mitsubishi Electric elevators and escalators are currently operating in approximately 90 countries around the globe. Built placing priority on safety, our elevators, escalators and building system products are renowned for their excellent efficiency, energy savings and comfort. The technologies and skills cultivated at the Inazawa Works in Japan and 12 global manufacturing factories are utilized in a worldwide network that provides sales, installation and maintenance in support of maintaining and improving product quality. As a means of contributing to the realization of a sustainable society, we consciously consider the environment in business operations, proactively work to realize a low-carbon, recycling-based society, and promote the preservation of biodiversity.

ISO9001/14001 certification

Mitsubishi Elevator Asia Co., Ltd. has acquired ISO 9001 certification from the International Organization for Standardization based on a review of quality management. The plant has also acquired environmental management system standard ISO 14001 certification.



mitsubishi electric corporation
 HEAD OFFICE : TOKYO BLDG., 2-7-3, MARUNOUCHI, CHIYODA-KU, TOKYO 100-8310, JAPAN

www.MitsubishiElectric.com/elevator

⚠ Safety Tips: Be sure to read the instruction manual fully before using this product.

MS

Revised publication effective Mar. 2021.
 Superseding publication of C-CL1-6-C9764-E Apr. 2020.
 Specifications are subject to change without notice.

©2021 Mitsubishi Electric Corporation