



POLYCAB

Connection Zindagi Ka



Automation is everywhere... so are we with our
Instrumentation, Control & Signal Cables



Connection Zindagi Ka



Company Profile

Polycab an ISO 9001:2008, ISO 14001:2004, OHSAS 18001:2007 company is India's no. 1 Cables & Wires Company with a glorious track record of over four decades. Our manufacturing facilities at Halol (Vadodara), Daman, Nashik & Roorkee in India, addresses to the specific needs with state-of-the-art machinery and technology.

Polycab's turnover has crossed ₹ 5000 crores (US\$ 800 million) in the fiscal year 2014-15 and is projected to cross ₹ 6000 crores (US\$ 1 billion) in fiscal year 2015-2016.

Polycab derives its strength from its customers and those being in sectors like Utilities, Power Generation, Transmission & Distribution, Petroleum & Oil Refineries, OEMs, EPC contractors, Steel & Metal, Cement, Chemical, Atomic Energy, Nuclear Plants, as well as Government partners like BSNL, Railways and Private Telecom Operators like Reliance, Vodafone, Airtel, Aircel, Tata, Idea and many more.

Polycab offers a variety of services:

- Commercially reasonable prices
- Reliable & consistent quality
- Product development as per market
- A target stocking policy
- Technical support for application

THINGS YOU DIDN'T KNOW ABOUT POLYCAB

Between its facilities in Daman, Halol (Vadodara), Nashik and Roorkee the company has 3.5 million square feet of manufacturing space.

Polycab manufactures enough cables each year to circumnavigate the earth three and a half times and enough wire to go to the moon and come back- four times.

Polycab has increased its turnover 100 times in sixteen years.

Over 300 Authorised distributors service its India needs and its overseas interests.

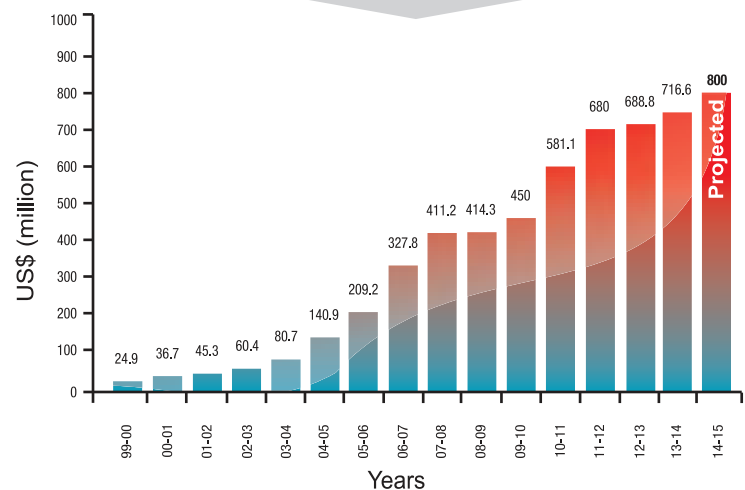

Chairman's Message

The journey of over four decades would not have been as exciting and fulfilling without the unconditional support of all our customers & our sales partners, I would like to express our deep gratitude to you, as you have made Polycab one of the outstanding companies in our industry.

Despite our rapid growth and elevation to the leadership position in the industry, the simplicity in Polycab's flexibility and openness to new market trends and changing technology continue to be our driving force. The core values of, simplicity, team work, trust amongst people, customer focus and meeting commitments have given us a unique position and respectability among the Indian industry.

Gearing up for the future and to keep winning in tomorrow's world, we have a well recognized market presence with a strong product & portfolio, streamlined and efficient manufacturing capabilities to withstand the winds of change. But we will need to be even more proactive, agile and customer centric. We will need to anticipate the future and be ready with solutions, even before the customer asks for them.

There are many new challenges the cable industry is facing with new market opportunities and product developments. Automation in all sphere's of business processing is becoming very important and innovation in this segment is inevitable. Polycab is extending its product range in this segment to meet your growing needs and many new products for specific applications will be introduced soon.

Polycab's business model is evolving. We are enhancing our key internal operations to ensure a consistent and positive experience for our customers. Our business processes will begin and end with the customers. We have identified focus areas of growth over the next 5 years and beyond. Polycab aspires to be a Rs. 10000+ crore company within the next 4 years.

We take this opportunity to thank you and convey our gratitude for the unabated support and trust you have always reposed on Polycab and encouraged it to move ahead confidently. We are confident that this will keep us ahead in our constant endeavour to be your preferred brand.

We hope to improve each day to serve you better.

HAPPY CABLING!!!



INDER T. JAISINGHANI
Chairman & Managing Director



“ A customer is the most important visitor on our premises.
He is not dependent on us. We are dependent on him.
He is not an interruption in our works. He is the purpose of it.
He is not an outsider in our business. He is part of it.

We are not doing him a favor by serving him he is doing us a favor by giving us an opportunity to do so.”

- Mahatma Gandhi



VISION

“ Our vision is to improve the quality of life and bring greater happiness to our customers. We will do so through reliable, safe sustainable and best in class products and services, while enhancing stake holder value continuously.”



CORE VALUES

Trust | Teamwork | Customer Delight | Action
Commitment | Excellence | Sustainability



	Page No.
A POLYCAB – Details Makes the Difference	2
B Construction and General Information	
1 Summary of Instrumentation Cable Manufacturing Process and Raw Material	3
2 Cable Construction, Performance & Raw Material	4 ~ 9
3 Interference/ Noise in Instrumentation & Signal Cables	10
4 Electrical Properties	11
5 Cabling Elements	12
6 Cross Sectional Drawings of various types of Instrumentation cables	13
C Technical Details	
Standards & References	14
Awg to sq.mm Conversion Table	14
D Dimensions Instrumentation Cables	
a Cables As per EN Standards	
1 300 volts Core PVC/PE insulated overall shielded cable	15
2 300 volts Pair/ Triad PVC/PE insulated overall shielded cable	16 ~ 17
3 300 volts Pair/ Triad PVC/PE insulated individual & overall shielded cable	18 ~ 19
4 500 volts Core PVC/PE insulated overall shielded cable	20 ~ 21
5 500 volts Pair/ Triad PVC/PE insulated overall shielded cable	22 ~ 25
6 500 volts Pair/ Triad PVC/PE insulated individual & overall shielded cable	26 ~ 29
b Cables Generally As per Indian Standards	
1 Pair/ Triad PVC/PE insulated overall shielded cable	30 ~ 33
2 Pair/ Triad PVC/PE insulated individual & overall shielded cable	34 ~ 37
3 Fire Survival - Pair/Triad EPR/Silicon insulated overall shielded cable	38 ~ 41
4 Fire Survival - Pair/Triad EPR/Silicon insulated individual & overall shielded cable	42 ~ 45
E Thermocouple Cables	
Thermocouple extension and compensating cables	46
Colour Codes for Thermocouple Extension & Compensating Cables	47
F Fire Resistance/ Fire Survival Cables	
Fire resistant / Fire Survival Instrumentation Cables	48
Properties of Fire Performance in Cables	49
G Triad & Quads Cables for Resistance Temperature Detectors (RTD)	50
H Quality Certification, 3rd Party Approvals	51
I Cables For Special Conditions & Applications	52
J Recommendations for Handling & Storage of Instrumentation Cables	53 ~ 54
K Details Preferred with Enquiry	55

Details Make The Difference

THE COMPANY

POLYCAB, an ISO 9001: 2008 company is India's No. 1 Wire & Cable manufacturer with a proven track record of over four decades. The fastest growing company in the Indian Cable Industry with consistent growth, Polycab has crossed Rs. 5000 crore turnover (US\$ 800 million) and is set to achieve Rs. 6000 crore turnover (US\$ 1 billion) during the year 2015-16.

From a modest beginning with Wires and Cables, over three decades ago Polycab set up State of Art manufacturing facilities at Daman & Vadodara. In the manufacture of cables, a competitive and leading edge rests not so much in product innovation as in consistent quality and ready availability. Polycab's Daman & Vadodara Manufacturing Facilities on 250 acres of land was created to address these key market determinants. The manufacturing set up is sourced out from the world renowned Machinery and Technology suppliers. To maintain leadership, we continually keep expanding our manufacturing capabilities with constant upgradations to deliver superior products to our customers.

CUSTOMER SATISFACTION

In an on-going process to improve Customer Satisfaction, Polycab offers a variety of services:

- Commercially competitive prices.
- Reliable & consistent quality.
- Reliable & just in time delivery.
- Product development for a changing market.
- A targeted stocking policy.
- Technical Support for Applications/Projects.

CUSTOMER FOCUSED

POLYCAB derives its strengths from its Customers. The Growth of the latter is a prerequisite to the growth of the Company and hence customer satisfaction is its prime objective. Over the years sincere service and dedication of its Customers has earned the Company distinguished clientele & Consultants which includes leaders in Sectors like Utilities, Power Generation, Transmission & Distribution, Petroleum & Oil Refineries, OEM'S, EPC contractors, Steel & Metal, Cement, Chemical, Atomic Energy & Nuclear Power etc. We are both motivated and well-positioned to meet the changing needs of our customers as we have the resources to diversify and to enhance our product lines.

POLYCAB has highly experienced qualified and dedicated professionals with strong adherence to the quality management system. Polycab has offices all over the country and has its Valued Network of Distributors / Dealers/ Agents/ Resellers on Nationwide Basis. In every 5 sq. kms area in India you would find one Dealer / Stockist Dealing in Polycab Products. Polycab is continuously expanding its global presence in Europe, Middle East, and Asia.

Polycab has earned the trust and reputation in India and abroad by winning the customers' confidence. Several thousands of kilometers of Instrumentation Cables have been manufactured and are in service in various prestigious and signature projects in India and abroad.

The steady growth in automation of production processes in industry, especially distributed process control across large user sites like oil refining and petrochemical plants, the steel industry, power stations etc. necessitates the reliable transmission of electrical signals, process data and control information.

Today, in a continuous process plants like refinery, fertilizer, cement, steel etc. various parameters like temperature, pressure, flow, level etc are converted in to electrical signals which are fed to control room. In control room these signals are analyzed compared and suitable commands are sent to the field to take corrective action. The control room has become the brain of the plant and instrumentation cables are the arteries.

Polycab's Instrumentation Cables are preferred choice by the Titans of Indian industry, leading EPC contractors, consultants and specifiers.

DETAILS MAKE DIFFERENCE

More than 4 decades of experience have enabled Polycab to develop a specific know how for each individual product line.

This is just not a catalog. It is what you have been looking for, a product guide for choosing the design you need for your project, plant or application. We wish it will allow consultants, manufacturers, OEM's, specifiers, engineers & contractors to save time when preparing specification or dealing with project requirement.

The application of combination design with national & international standards as available here should be a logical and standard type of instrumentation cable to meet general application needs.

Polycab's philosophy to exceed expectations begins by offering a comprehensive product portfolio from Wires to EHV cables. Polycab also offers other specialized cables like Foundation Fieldbus Cables (Profibus), Communication Cables, VFD cables, Silicon Insulated Cables and various other cables insulated with exceptional Polymer materials suitable for higher conductor temperatures.

For your any special types of application needs the product data and quotation are available on request.

OTHER AVAILABLE CATALOGS

- Flexible cables
- LT PVC power and control cables
- LT XLPE power and control cables
- HT cables upto 45 KV
- EHV cables upto 132 kv
- Fire survival cables
- Photovoltaic cables
- Special cables & wires for high rise buildings

Caution:

Instrumentation cables are not designed for use with power supplies and should not be connected to the mains power.

Polycab Wires Pvt. Ltd. takes every precaution to ensure the information given in this publication is correct. E.&O.E. all information is subject to change without notice.

Summary of Instrumentation Cable Manufacturing Process and Raw Material used

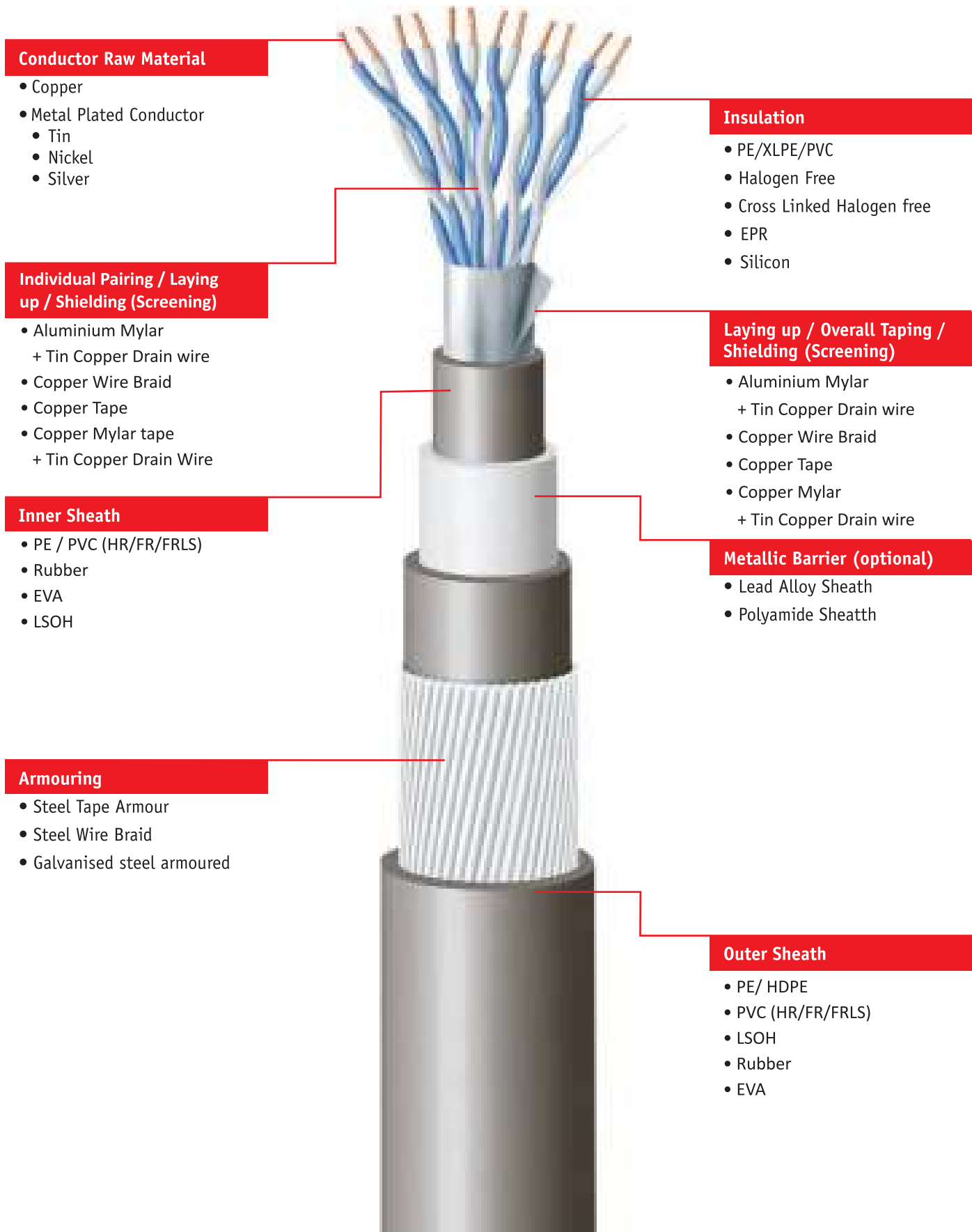

Cable Construction, Performance & Raw Material

CONDUCTOR:

The metallic part of the cable which conducts the electricity is called conductor. In case of instrumentation cable it is invariably of copper as

- a) It has got better conductivity (Next to silver)
- b) It is free from oxide film in normal atmosphere.
- c) It is ductile and does not easily break when bent sharply. It can be drawn in to fine wires (45swg)
- d) It can be soldered easily

Copper has got affinity for sulphur and hence where sulphur is present it should be protected by tinning. All regular rubber cable has sulphur added in rubber for vulcanization and hence tinned copper conductors are always used in rubber cable. In bigger sized cable a separator tape is applied on bare copper conductor to prevent it from coming into contact with sulphur in rubber.

Conductor for high temperature rating i.e PTFE and FEP insulated cable is of silvered copper to protect the copper from oxidation at higher process and operating temperature (About 200C).

In case of compensating cable the conductor material depend upon its type. This is discussed in detail in section Themocouple Extension Cable & Compensating Cables.

CONDUCTOR CONSTRUCTION:

In general any one of the following conductor constructions is employed for conductor.



a) SOLID (Class 1): the conductor is made of one solid wire i.e for 1.50 sq.mm conductor there will be one Wire of 1.38 mm diameter and it is denoted as 1/1.38 mm



b) STRANDED (Class 2): The conductor is made of several wires (strands) laid up together. Here six strands are laid around one central strand. For 1.50 sq.mm conductor there will be 7 strands of 0.53 mm.dia.each and it is denoted as 7/0.53 mm



c) FLEXIBLE (class 5) : The conductor is made of several wires twisted together in one direction i.e for 1.50 sq.mm there will be 30 wires of 0.25 mm dia. each and it is denoted as 30/0.25 mm.

The relative merits of the above constructions are as under:

Construction	Bending Capacity	Crimping Of Lugs	Suitable For Termination
Solid	Poor	Not Recommended	Screw
Stranded	Good	Recommended	All Types
Bunched	Best	Recommended	All Types



INSULATION:

The coating over the conductor, which insulates it from other conductor and earth is called insulation and it must have

- a) Good electrical properties
- b) Better heat stability
- c) Should not be affected by normal environmental conditions
- d) Flexibility
- e) Reasonable price

Considering the above the insulation material can be divided into 2 classes

1. Thermoplastic and
2. Thermoset (Cross Linked)

Thermoplastic Material:

These are the plastics which when heated their linear molecule chains drift apart and become soft and regain their original form on cooling. PVC, POLYETHYLENE, PROPYLENE and NEW generation of LSZH (Low smoke Zero Halogen) are thermoplastics materials and cannot be used at higher temperatures. They can be recycled number of times.

NYLON is polyolefine material and can be used for higher temperature as well tough applications.

Thermosetting Material:

These are plastics and rubber when initially heated, their linear molecule chains get interlinked and this is not reversible. Due to this they can be operated at higher temperature. VULCANIZED RUBBER, CROSSLINK POLYETHYLENE, SILICON RUBBER, OTHER RUBBERS SUCH AS EPR, EVA are thermosetting material and they cannot be recycled.

DIFFERENT TYPE OF INSULATING MATERIALS ARE MENTIONED BELOW :

Polyvinyl Chloride (PVC) Compound:

This is the most widely used Plastic due to its versatility. Unlike other plastics this cannot be used alone. It is required to be mixed with other ingredients like plasticizers, fillers, stabilizers, lubricants etc. to make it workable. By varying the ingredients and their proportions in the compound the end properties can be varied to a great extent to meet the specific requirements.

The normal PVC insulated cables are suitable for continuous 70°C operation. By changing the plasticizer and stabilizer we can have HR PVC which is suitable for continuous 85°C operation. Due to higher dielectric constant and hence higher mutual capacitance it is not suitable for operation above audio frequency i.e.20 kilohertz.

Low Density Polyethylene (LDPE):

This has got excellent electrical properties but is suitable for continuous 60 degree Celsius operation and hence it is not used in Power Cable. Due to its low dielectric constant it is widely used for telephone and radio frequency cable.

Cross Linked Polyethylene (XLPE):

Cross Linked Polyethylene meeting ICEA S-82-252 standards can withstand higher temperature of 90°C due to Crosslinking of ethylene chains and hence it is widely used for LT and HT power cables. XLPE capable of withstanding 105°C and 125°C conductor temperatures can also be offered.

Fluorinated Ethylene Propylene (FEP) and Polytetrafluoroethylene (PTFE):

These are other plastics, which are used as insulating material for higher temp. application (200°C) They have not found wide application due to their prohibitive cost.

Ethylene Propylene Rubber (EPR)

Ethylene propylene rubber is a common synthetic rubber polymer used as an insulation in electrical wire and cable and control/instrumentation cables.

Because of its rubber-like characteristics, EPR is used in many highly flexible cables. Its dielectric strength is good but not as high as that of PE or XLPE

EPR is abrasion resistant and is suitable for use at temperatures down to -60°C. It is fairly flame retardant and can be made even more flame retardant by careful formulation. EPR's high-temperature characteristics are very good. Some formulations can withstand continuous temperatures as high as 150°C.

Silicone

Silicone is a soft, rubbery insulation that has a temperature range from -80°C to 200°C. It has excellent electrical properties plus ozone resistance, low moisture absorption, weather resistance, and radiation resistance. It typically has low mechanical strength and poor scuff resistance.

SCREENING

Two individual conductors are uniformly twisted to form pairs which are then assembled. The paired conductors may be

1. Unscreened
2. Individually and overall screened (shielded)
3. Overall Screened (Shielded)

Screens (Shields) are often used in Instrumentation and signal cables to prevent or decrease possible interference/ noise in cables that can be caused by following reasons:

1. Cross-talk from adjacent pairs or triads
2. Interference induced by external source such as electrical equipment's machineries and powerlines

Screens are normally as under:

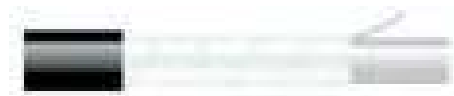

- Aluminum/ polyester tape with a tinned copper drain wire, the most common construction



- Copper/ polyester tape with a tinned copper drain wire, for a superior screen effect.



- Bare copper braid, for electromagnetic interference/ noise or when the cable is subject to movements.



- Tinned copper braid for electromagnetic interference in existence of corrosive atmosphere

Aluminum- Polyester or Copper- Polyester Shielding

Here the shielding is provided by wrapping of Aluminum or Copper foil bonded with Polyester film is also known as Mylar which is a trade name and hence sometimes it is called Alu-Mylar or Copper-Mylar shielding.

It is observed that in case of Electrostatic Interference the coverage is more important than conductance of the shield and hence thin Aluminum/copper foil (B.S. 5300 specifies a minimum thickness of 0.008 mm i.e. 8 Micron thickness for Aluminum/copper foil) is used for shielding for economic reasons. This foil has poor tensile strength and it breaks while wrapping. To provide mechanical strength Polyester film is laminated to Aluminum/copper foil. The Polyester film apart

from providing strength also acts as additional insulation for shield isolation.

Sometimes clients insist on 50 to 75 Micron Aluminum/copper foils which may not offer any additional advantage but adds to the cost.

A tinned copper drain wire is provided in continuous contact with the Aluminum side of the tape all along the length of the cable. As the name suggests it drains off electrostatic interference. It helps to connect the Aluminum/copper polyester tape to earth at the termination. Moreover it takes care of any breakage in the tape in providing continuous earth around the circuit. The most common size of the drain wire is 0.5sq.mm stranded or solid (20AWG). Stranded construction is preferred as it does not protrude above the tape and chances of its breakage are less.

Generally a plain polyester tape of thickness 0.025 mm (25 Micron) is provided over the laid up cable element, over which the drain wire runs and above that Aluminum/ copper polyester tape is wrapped. The plain polyester tape keeps the drain wire always in contact with the Aluminum/copper foil.

Bare/ Tinned Copper Braid

Here the shield is provided in the form of wire mesh around the cable circuits. Fine gauged soft wire of plain copper/ tinned copper are woven around the circuit. The finer the mesh better is its effectiveness. Due to its low resistance it provides better screening against Electromagnetic Interference but as it is not fully covered it is less effective against Electrostatic Interference when compared to Alu-polyester shielding.

It is much costlier than Alu-polyester shielding and it is generally used in cable which are used for flexible and nonstatic applications. Apart from providing shielding it also offers mechanical protection to inside circuits.

We recommend PVC inner sheath below braiding instead of plain polyester tape as it offers better mechanical protection to inside conductor against the damage caused by the wires of the braid due to constant movement.

Screen/ Shield Application

Screens/ shields if applied to each individual pairs/ triples (triads) is known as individual screen/ shield. Screen/ shield applied on the bundle (after laying up of pairs/triads) of the cable is known as overall screened/ shield.

LAYING UP OF ELEMENTS:

The required number of cabling element (Shielded or Unshielded) or cores are stranded (laid up) concentrically in layers to form the laid up cable. Cable up to eight element will have one layer. For cable having more than eight elements there will be two or more layer and they are laid in opposite direction.

NYLON RIP CORD:

Sometimes a nylon thread of sufficient strength along the cable is provided under the inner sheath. It helps in removal of inner sheath without damaging the insulation at the time of termination or jointing. It is more useful in control and power cable where the inner sheath has a tendency to stick to the inside insulation due to the absence of any separator between them.

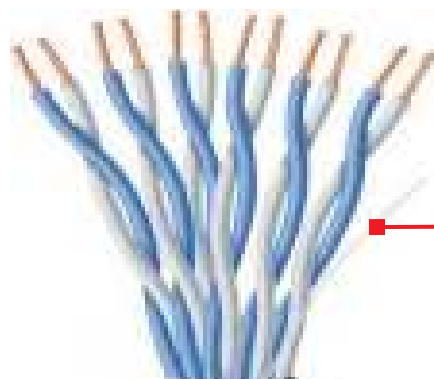

PROTECTION (OPTIONAL):

Lead sheath:

In addition to mechanical protections discussed above special protection can be considered for specific installations. Lead sheath is applied between inner sheath and outer sheath and is the best shield against destructive chemicals. However this is a costly solution and it increases weight of the cable and bending radius. However it is preferable to have armour to protect the lead sheath from crushing.

Polyamide

It is an alternative to Lead Sheath and is composed by a longitudinal overlapped aluminium copolymer coated tape bonded to HDPE jacket and additional polyamide/polypropylene sheath.

It has excellent protection against corrosion and humidity. This protection has a lower weight compared to lead sheath, cables have a smaller diameter, with a reduction of costs.

PVC INNER SHEATH:

Inner sheath of PVC either extruded / tape is provided over the overall shield as a bedding for the shield and armour to avoid common mode interference. Extruded sheath also adds to the circularity of the cable.

Taped inner sheath is not recommended as it is not impermeable and in case of any puncture in the outer sheath the water reaches right upto shielding and corrodes it.

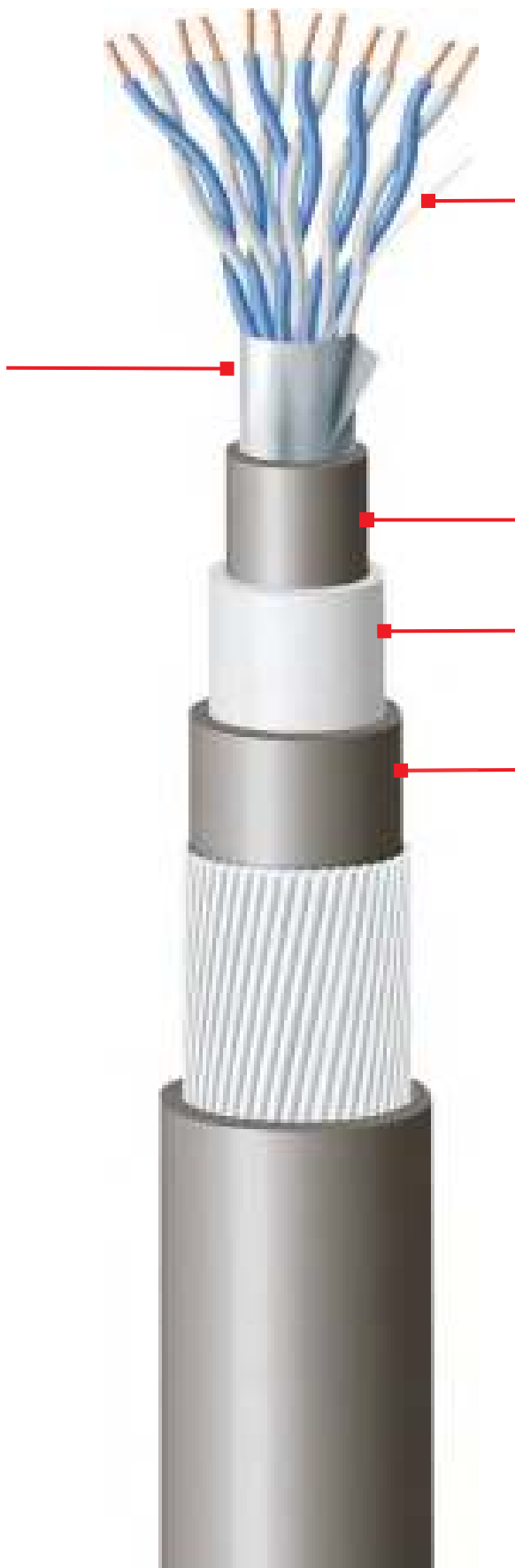

Cable Construction, Performance & Raw Material

ARMOURING:

Armouring is provided over the inner sheath when cables have to be installed direct buried for mechanical protection. Its conductance is not as important in Instrumentation cable as it is in Power cable where it has to carry heavy earth return current in case of short circuit.

Steel armouring also provides protection against Electromagnetic interference due to its magnetic nature. It also provides protection to inside cable against Rodent attack which is quite common in tropical countries like India.

The following points must be considered while considering armouring:

- Required tensile load
- Minimum required bending radius
- Protection against rodent attack
- Protection against accidental/ external damage
- Expected pressure on cable during service



GSFA: Galvanised Steel Flat Armoured, is composed of flat wires of thickness of 0.80mm. Where diameter under armour is above 13.0 mm galvanised steel strip of size 4.0 mm X 0.80 mm is generally used. This type of armour is similar to SWA/ RWA.



SWA/RWA: Single Layer of Galvanised Steel wires with diameters according to relevant standards is applied. This type of armour normally assures a very good mechanical protection and tensile strength. Generally galvanised mild steel wires of 0.90 mm diameter are used for armouring in cable where diameter under armour is 13.0 mm or less.



GSWB: Galvanised Steel Wire Braid in the form of wire mesh around the cable is applied. It assures a good mechanical resistance and lower bending radius compared to other types of armour. This type of braided armouring is preferred when there is movement or vibration. For special application it is also possible to use stainless steel or tinned copper wires.



GSTA: Galvanised Steel Tape Armoured, comprises of 2 tapes with overlapped edge. The thickness of the tape is to be designed according to cable diameter. It grants a coverage of more than 100%. It has very good crush resistance but has fair tensile strength.



OUTER SHEATH:

The coating on the armouring is known as outer sheath. Many compounds can be used as sheath material. Different grades are available to meet specific working conditions. The following factors have to be evaluated to decide the outer sheath material:

- Better abrasion resistance
- Type of installation – outdoor/ indoor, direct buried..
- Possible presence of humidity, oil, chemicals etc
- Behavior in case of fire (Fire Retardant, Fire Resistance, emission of gases and smoke)
- Range of temperature
- Better weatherproof properties. It must be stable against ultraviolet rays in case of exposure to sun.
- Cost

Considering the above the most acceptable material for outer sheath is PVC compound. It has good fire resistance due to its chlorine content. It burns when the flame is applied but fire gets extinguished immediately on removal of flame.

Fire resistance of plastics is expressed by their Oxygen Index. Oxygen Index indicates the percentage of Oxygen required in air, so that the plastic will burn like a candle at room temperature. The Oxygen Index of normal PVC used in cable is 25% while that of Polyethylene is 19%. Oxygen Index decreases with the rise in temperature and at a particular temperature it will drop to 20% and will burn like a candle. This temperature in degree celsius is known as temperature Index. Temperature Index of PVC in cable is 250C.

Over the year the size of petrochemical, chemical and Power plant has increased tremendously. Moreover the automation has also increased. As a result now many cable are bunched in the cable shafts and on the cable trays. In case of a fire in these cable, the fire become self-sustaining. Moreover due to burning of PVC a dense corrosive smoke is emitted which makes firefighting difficult due to poor visibility and toxic nature of the smoke. The HCL content of smoke not only damages other nearby costly equipment but also penetrates the RCC structure and corrodes its steel reinforcement due to this there is an extensive damage to the human life and property.

To overcome these deficiencies of PVC sheath, FR (Fire Retardant) PVC compound having a minimum Oxygen Index of 29% was developed, by adding Antimony Trioxide at compounding stage. FR PVC is preferred in Petroleum and Petro Chemical Plant which are open to the sky. FRLS (Fire Retardant Low Smoke) PVC compound is a further development where Aluminium Trihydrate (ATH) and some chemical are added at compounding stage to increase the Fire Resistance of the PVC and to decrease the smoke emission and toxicity of smoke. But again this is a PVC compound and hence toxic black smoke cannot be eliminated completely.

Zero Halogen Fire Retardant (ZHFR) Compound:

As discussed above, PVC has got better fire resistance due to its chlorine (Halogen) Content but it creates other problem during fire. To overcome these deficiencies ZHFR compounds were developed. Here Polyethylene or Ethylene Vinyl Acetate (EVA) plastics which are having zero halogen are imparted fire resistance properties by compounding them with certain chemicals. These materials when burn, emit little nontoxic smoke. This is the most preferred sheathing compound for underground Metros, Stations, Airports, Theatres, and Hospitals etc where human density is more.

Polyethylene Outersheath:

Due to poor abrasion and fire resistance Polyethylene sheaths are generally not used. Moreover minimum 2.5% carbon black content is required in Polyethylene to prevent its degradation due to ultra violet rays when exposed to sunlight. It is mainly used where better chemical and water resistance are required.

Nylon & Polyurethane Sheaths:

These plastics have better abrasion resistance and are used when there are specific requirement.

Colour of Outersheath:

By default it is black as it imparts weatherproof properties. In case of cable used for intrinsically safe systems blue sheath is provided. Sometimes the clients specify Grey or Red sheath to differentiate the instrumentation cable from the normal cables.

Interference/ Noise in Instrumentation & Signal cables

The signals are in millivolts and milliamperes and hence they must be protected by suitably designed Instrumentation Cables to screen off any outside interference. Any distortion of the signals will lead to malfunctioning of the system. A noise free signal is important to avoid mistakes.

The interference which is also called noise can be due to:

- External source like nearby power lines, big motors, generators etc.
- Internal source like voltage or current in the other circuit of the same multi-pair cable.

There are four basic types of interference which affect process instruments. They are:

1. ELECTRO STATIC
2. ELECTRO MAGNETIC
3. COMMON MODE
4. CROSS TALK

ELECTRO STATIC

Any voltage source radiates electric field and this field will induce emf in the circuit which is coactively coupled to the voltage source. The most effective way to protect the circuit to place the circuit inside a total coverage shield, which is earthed.

The best shielding is provided by wrapping Aluminium foil bonded with polyester around the cable as this provides 100% coverage. Moreover the electrical interference induce very small currents and hence the conductance of the thin aluminium foil is sufficient.

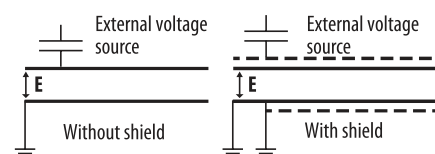

ELECTRO MAGNETIC

Generally low frequency electromagnetic field due to power cables, motors, etc. can induce EMF into the instrumentation cable. The twisting of conductors provides a good magnetic noise reduction. Other reductions are given by steel conduit, armours (high inductance material). In some particular cases low resisting screen (i.e. copper braids, copper tapes) may be necessary.

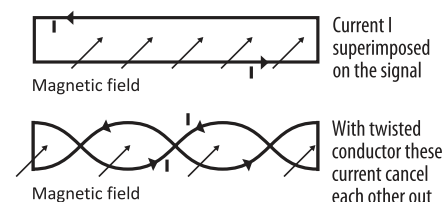

COMMON MODE

Different ground potential at different locations in a process plant cause common mode as it will give rise to a current in the shield which will affect the signal. To avoid this, ground the shield at one end only. This problem is more prominent in thermocouple extension leads (compensating Cables). For rapid response grounded thermocouples are used. The junction of the thermocouple is connected physically and electrically to the thermowell wall in which it is installed. In case of multiplier compensating cable for use with grounded thermocouples, each pair should be individually shielded and grounded at corresponding thermowell. Moreover all the shields must be isolated from each other.

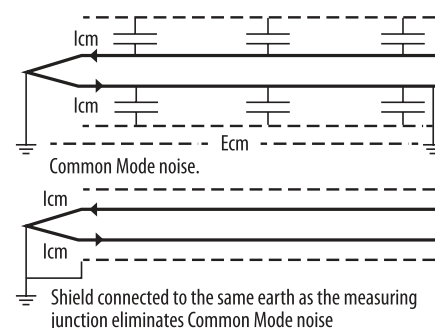

CROSS TALK

This occurs with AC instrument signals, especially pulse type signals when more than one circuit is carried in the same cable. In case of multipair cables, the signal in a circuit gets coupled to a second circuit super imposing interference (noise) on a circuit. One way to combat this is to use pairs with staggered lay lengths in the same multipair cables i.e. the lay lengths of two nearby pairs are different. The best way to eliminate this is to use individually shielded pairs in multipair cable. Moreover these shields must be isolated from each other. The individual pair shield protects the pair from noise picked up from the adjacent pairs, as well as reduces the noise radiated by the pair it surrounds.

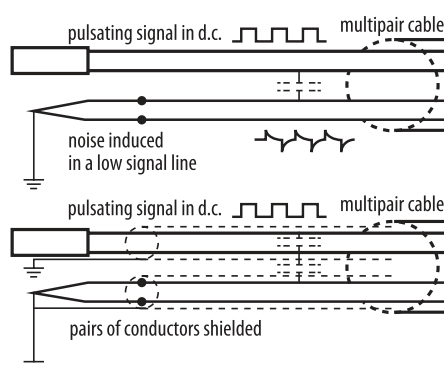

Electrical Properties at 20° C

ELECTRICAL PROPERTIES FOR MULTICORE / SINGLE & MULTI PAIR

	Unit	Conductor size				
		0.5 mm ²	0.75 mm ²	1.0 mm ²	1.5 mm ²	2.5 mm ²
INSULATION RESISTANCE						
a) PVC Insulated	MΩ/km	10	10	10	10	10
b) PE Insulated	MΩ/km	1000	1000	1000	1000	1000
c) XLPE Insulated	MΩ/km	1000	1000	1000	1000	1000
MUTUAL CAPACITANCE AT 1000 HZ						
a) PVC Insulated	nf/km	<250	<250	<250	<250	<250
b) PE Insulated	nf/km	<150	<150	<150	<150	<150
c) XLPE Insulated	nf/km	<150	<150	<150	<150	<150
L/R ratio	(L/R) μH/Ω	<25	<25	<25	<40	<60
TEST VOLTAGE						
Core / Core	kV	2kVac for 1 min				
Core / Screen	kV	1kVac for 1 min				
Rated Voltage	V	500	500	500	500	500

CONDUCTOR RESISTANCE

SIZE	MULTICORE /SINGLE PAIR/SINGLE TRIAD				MULTI PAIR/MULTI TRIAD			
	CLASS 1 & CLASS 2		CLASS 5 & CLASS 6		CLASS 1 & CLASS 2		CLASS 5 & CLASS 6	
	PLAIN	TINNED	PLAIN	TINNED	PLAIN	TINNED	PLAIN	TINNED
0.5	36	36.7	39	40.1	36.7	37.4	39.78	40.9
0.75	24.5	24.8	26	26.7	25	25.3	26.52	27.23
1	18.1	18.2	19.5	20	18.5	18.6	19.89	20.4
1.5	12.1	12.2	13.3	13.7	12.3	12.4	13.56	13.97
2.5	7.41	7.56	7.98	8.21	7.56	7.71	8.14	8.37

Cabling Elements

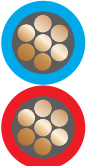
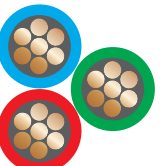
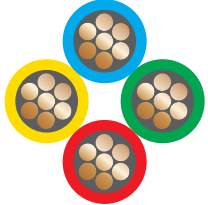
CORE	PAIR	TRIAD	QUAD
			
Insulated conductor is known as core	Two cores twisted to form a pair	Three cores twisted to form a Triad	Four cores twisted to form a Quad

INDIVIDUAL SHIELDING OF ELEMENT:

In case where individual shielding is required, the above element are wrapped first with Plain polyester, then the drain wire is laid parallel, over it Aluminum- polyester tape is applied with Aluminum side touching the drain wire. Above this a plain polyester tape is applied for shield isolation from other shields.

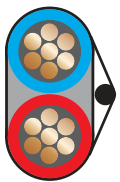
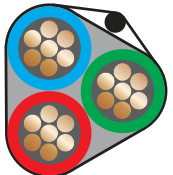
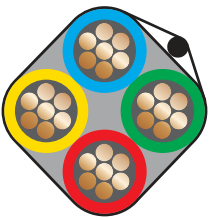
SHIELDED PAIR 	SHIELDED TRIAD 	SHIELDED QUAD 
---	---	---

Core and Pair Construction

There is a confusion in specifying the cable required. If you ask for 24 Core X 1.50 sq.mm cable, we take 2 cores and twist them in one direction, above that 8 cores are laid in opposite direction and above that 14 cores are laid and it looks as drawing (a).

If you specify 12 Pair cable, first we take 2 cores and twist them to form a pair, 3 such pairs are again laid up, above that 9 such pairs are laid up to form a 12 pair cable and it look as drawing (b).

The diameter of multi paired cable is always more than that of multicore core cable having the same number of insulated cores and hence multi pair construction is always costlier.

NOTE: One Pair and Two Core cables are generally the same.

Drawing (a)
24 Core
Cable

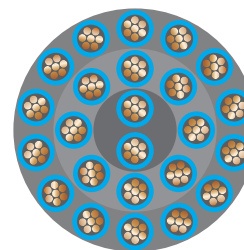

Drawing (b)
12 Pair
Cable

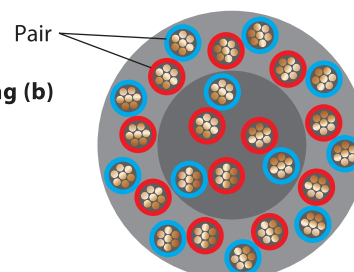

Typical Cross Sectional Drawing of Instrumentation Cables

4 Pair Overall Shielded Unarmoured

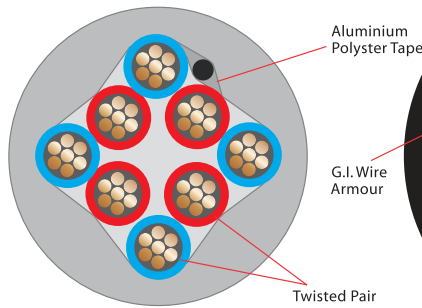

4 Pair Overall Shielded round Armoured Cable

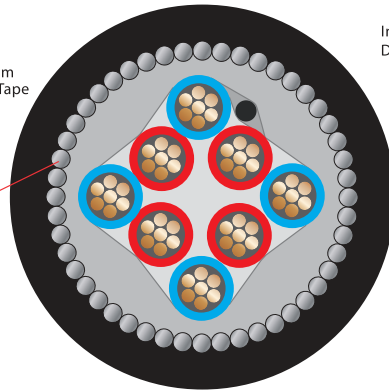

4 Pair Individual & Overall Shielded round Armoured Cable

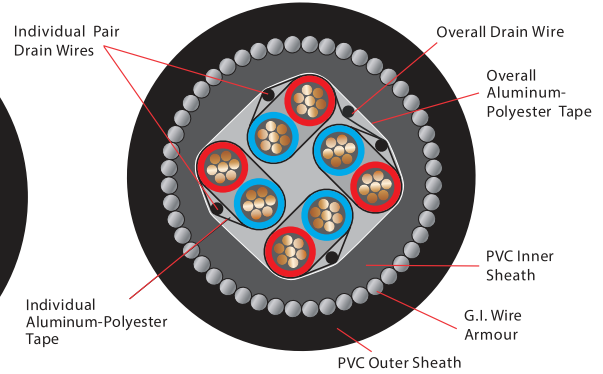

6 Core Overall Shielded Unarmoured

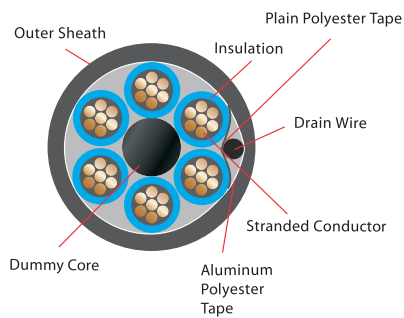

6 Core Overall Shielded Armoured

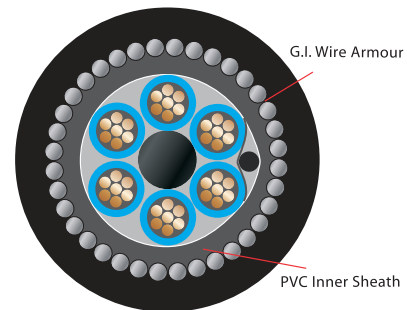

12 Triad Overall Shielded Unarmoured Cable

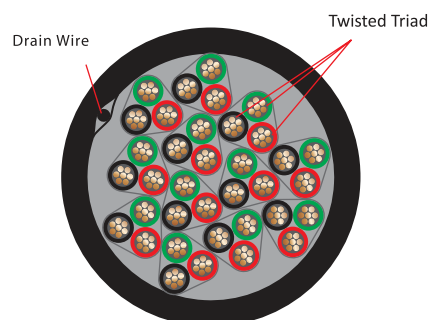

12 Triad Overall Shielded Strip Armoured Cable

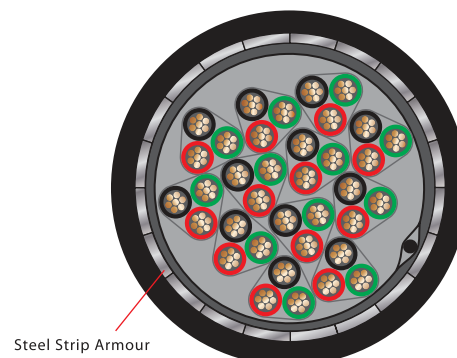

Polycab Instrumentation cable is manufactured according to Indian & Various International Standards. Cable Constructions and properties can be based on following standards:

Description	Indian standard	VDE	BS	IEC
Conductor	IS 8130	0295	EN60228	60228
Insulation	IS 1554/7098 Part 1		EN50290	
Shielding			BS 50288	
Inner & Outer Sheath	IS 1554/7098 Part 1		EN50290	
Armour	IS 1554/7098 Part 1		BS 50288	

All the instrumentation cable at Polycab is manufactured in Quality Assurance System Compliant with ISO 9001. The cable covered by the present catalogue comply with the regulation and standards consistent with IS, BS & IEC standards.

GLOSSARY:

IS- Indian Standards published by Bureau of Indian Standard (BIS)

VDE – Verband Der Elektrotechnik (Germany)

BS – British Standards

IEC – International Electrotechnical Commission

American Wire Gauge to mm² (Millimetre Sq.) Conversion Table

AWG TO MM ² CONVERSION TABLE	
AWG/kcmil	mm ² *
20	0.52
18	0.82
16	1.31
14	2.08
12	3.31
10	5.26
8	8.36
6	13.3
4	21.14
2	33.6
1	42.4
1/0	53.5
2/0	67.4
3/0	85
4/0	107
250	127
300	152
350	177
400	203
450	228
500	253
600	304
750	380
800	405
1000	507

MM ² TO AWG CONVERSION TABLE		
MM ²	mm ² *	AWG/kcmil
0.5	0.52	20
0.75	0.82	18
1.5	1.31	16
2.5	2.08	14
2.5	3.31	12
4	3.31	12
6	5.26	10
10	8.36	8
16	13.3	6
25	21.2	4
35	33.6	2
35	42.4	1
50	53.5	1/0
70	67.4	2/0
95	85	3/0
95	107	4/0
120	107	4/0
120	127	250
150	152	300
185	177	350
185	203	400
240	228	450
240	253	500
300	304	600
400	380	750
400	405	800
500	507	1000

*Equivalent cross sectional area

*Multiple choice of selection

Weight & Dimension Data

300 VOLTS, MULTI CORE, STR.COPPER, PVC/PE INSULATED ALUMINIUM MYLAR TAPED OVERALL SHIELDED, ARMoured AND UNARMoured INSTRUMENTATION CABLES AS PER EN 50228

Area of conductor	No of cores	Minimum thickness of insulation	ARMoured CABLES						UNARMoured CABLES				Normal Drum Length with $\pm 5\%$
			Nominal thickness of inner sheath	Diameter of G.I. armour wire	Nominal thickness of outer sheath	Nominal overall diameter	Approx. weight - PE insulation	Approx. weight - PVC insulation	Nominal thickness of outer sheath	Nominal overall diameter	Approx. weight - PE insulation	Approx. weight - PVC insulation	
mm ²		mm	mm	mm	mm	mm	kg/km	kg/km	mm	mm	kg/km	kg/km	m
0.5	2	0.26	0.8	0.9	1.3	9.6	180	180	0.8	5.2	38	40	1000
0.5	3	0.26	0.8	0.9	1.3	9.9	195	195	0.8	5.5	45	47	1000
0.5	4	0.26	0.8	0.9	1.3	10.3	210	215	0.8	5.9	53	57	1000
0.5	5	0.26	0.9	0.9	1.3	11.0	235	240	0.9	6.6	63	67	1000
0.5	6	0.26	0.9	0.9	1.3	11.5	260	265	0.9	7.1	73	78	1000
0.5	7	0.26	0.9	0.9	1.3	11.5	260	270	0.9	7.1	76	82	1000
0.5	8	0.26	0.9	0.9	1.3	12.3	285	295	0.9	7.9	85	92	1000
0.5	10	0.26	0.9	0.9	1.4	13.4	330	340	0.9	8.8	100	110	1000
0.5	12	0.26	0.9	0.9	1.4	13.7	345	355	0.9	9.1	115	125	1000
0.5	16	0.26	1.0	0.9	1.4	14.8	410	425	1.0	10.2	150	165	1000
0.5	18	0.26	1.0	0.9	1.4	15.3	435	450	1.0	10.7	165	180	1000
0.5	19	0.26	1.0	0.9	1.4	15.3	440	455	1.0	10.7	170	185	1000
0.5	20	0.26	1.0	0.9	1.4	15.9	465	485	1.0	11.3	185	200	1000
0.5	24	0.26	1.0	0.9	1.4	17.0	510	540	1.0	12.4	205	230	1000
0.5	30	0.26	1.1	0.9	1.5	18.1	590	620	1.1	13.3	255	280	1000
0.5	37	0.26	1.1	0.9	1.5	19.1	660	690	1.1	14.3	300	335	1000
0.75	2	0.26	0.8	0.9	1.3	10.1	195	200	0.8	5.7	46	48	1000
0.75	3	0.26	0.8	0.9	1.3	10.4	210	215	0.8	6.0	55	58	1000
0.75	4	0.26	0.9	0.9	1.3	11.1	240	245	0.9	6.7	69	73	1000
0.75	5	0.26	0.9	0.9	1.3	11.6	265	270	0.9	7.2	79	84	1000
0.75	6	0.26	0.9	0.9	1.3	12.2	290	295	0.9	7.8	92	98	1000
0.75	7	0.26	0.9	0.9	1.3	12.2	290	300	0.9	7.8	96	105	1000
0.75	8	0.26	0.9	0.9	1.4	13.2	330	340	0.9	8.6	110	115	1000
0.75	10	0.26	1.0	0.9	1.4	14.5	390	400	1.0	9.9	135	145	1000
0.75	12	0.26	1.0	0.9	1.4	14.8	410	420	1.0	10.2	155	165	1000
0.75	16	0.26	1.0	0.9	1.4	15.8	475	490	1.0	11.2	195	215	1000
0.75	18	0.26	1.0	0.9	1.4	16.4	510	530	1.0	11.8	220	235	1000
0.75	19	0.26	1.0	0.9	1.4	16.4	510	530	1.0	11.8	220	245	1000
0.75	20	0.26	1.0	0.9	1.4	17.0	550	570	1.0	12.4	240	265	1000
0.75	24	0.26	1.1	0.9	1.5	18.7	630	650	1.1	13.9	280	305	1000
0.75	30	0.26	1.1	0.9	1.5	19.5	700	730	1.1	14.7	340	370	1000
0.75	37	0.26	1.1	0.9	1.5	20.6	800	840	1.1	15.8	405	445	1000
1.0	2	0.26	0.8	0.9	1.3	10.4	210	215	0.8	6.0	53	56	1000
1.0	3	0.26	0.9	0.9	1.3	10.9	240	245	0.9	6.5	68	71	1000
1.0	4	0.26	0.9	0.9	1.3	11.5	270	275	0.9	7.1	82	87	1000
1.0	5	0.26	0.9	0.9	1.3	12.1	290	295	0.9	7.7	94	100	1000
1.0	6	0.26	0.9	0.9	1.3	12.7	320	330	0.9	8.3	110	120	1000
1.0	7	0.26	0.9	0.9	1.3	12.7	325	335	0.9	8.3	115	125	1000
1.0	8	0.26	0.9	0.9	1.4	13.8	370	380	0.9	9.2	130	140	1000
1.0	10	0.26	1.0	0.9	1.4	15.2	435	445	1.0	10.6	165	175	1000
1.0	12	0.26	1.0	0.9	1.4	15.5	465	480	1.0	10.9	190	205	1000
1.0	16	0.26	1.0	0.9	1.4	16.7	540	560	1.0	12.1	240	260	1000
1.0	18	0.26	1.0	0.9	1.4	17.3	580	610	1.0	12.7	270	290	1000
1.0	19	0.26	1.0	0.9	1.4	17.3	590	610	1.0	12.7	275	300	1000
1.0	20	0.26	1.1	0.9	1.5	18.4	650	670	1.1	13.6	305	330	1000
1.0	24	0.26	1.1	0.9	1.5	19.8	720	750	1.1	15.0	350	380	1000
1.0	30	0.26	1.1	0.9	1.5	20.6	810	850	1.1	15.8	420	455	1000
1.0	37	0.26	1.2	0.9	1.5	22.1	940	980	1.2	17.3	510	560	1000
1.5	2	0.35	0.9	0.9	1.3	11.6	260	265	0.9	7.2	74	78	1000
1.5	3	0.35	0.9	0.9	1.3	12.0	285	290	0.9	7.6	92	97	1000
1.5	4	0.35	0.9	0.9	1.4	12.9	330	335	0.9	8.3	115	120	1000
1.5	5	0.35	0.9	0.9	1.4	13.6	360	370	0.9	9.0	130	140	1000
1.5	6	0.35	1.0	0.9	1.4	14.6	415	425	1.0	10.0	160	170	1000
1.5	7	0.35	1.0	0.9	1.4	14.6	420	435	1.0	10.0	170	180	1000
1.5	8	0.35	1.0	0.9	1.4	15.8	470	485	1.0	11.2	190	205	1000
1.5	10	0.35	1.1	0.9	1.5	17.6	560	580	1.1	12.8	235	255	1000
1.5	12	0.35	1.1	0.9	1.5	18.0	600	630	1.1	13.2	275	295	1000
1.5	16	0.35	1.1	0.9	1.5	19.4	710	740	1.1	14.6	350	380	1000
1.5	18	0.35	1.1	0.9	1.5	20.2	780	810	1.1	15.4	395	425	1000
1.5	19	0.35	1.1	0.9	1.5	20.2	790	820	1.1	15.4	400	435	1000
1.5	20	0.35	1.2	0.9	1.5	21.2	850	890	1.2	16.4	445	480	1000
1.5	24	0.35	1.2	1.25	1.6	23.9	1090	1140	1.2	18.2	510	550	1000
1.5	30	0.35	1.3	1.25	1.6	25.1	1250	1300	1.3	19.4	630	680	1000
1.5	37	0.35	1.3	1.25	1.7	26.9	1430	1500	1.3	21.0	750	820	1000

For Cables of sizes or cores not listed above the product data is available on request
Larger Drum Lengths are possible against specific requirements on request

• Dimensions & Weights are representative figures and may vary

Weight & Dimension Data

300 VOLTS, SINGLE AND MULTI PAIR, STR .COPPER, PVC/PE INSULATED ALUMINIUM MYLAR TAPED OVERALL SHIELDED, ARMoured AND UNARMoured INSTRUMENTATION CABLES AS PER EN 50228

Area of conductor	No of pair	Minimum thickness of insulation	ARMoured CABLES						UNARMoured CABLES				Normal Drum Length with ± 5%
			Nominal thickness of inner sheath	Diameter of G.I. armour wire	Nominal diameter over armour	Nominal overall diameter	Approx. weight - PE insulation	Approx. weight - PVC insulation	Nominal thickness of outer sheath	Nominal overall diameter	Approx. weight - PE insulation	Approx. weight - PVC insulation	
mm ²		mm	mm	mm	mm	mm	kg/km	kg/km	mm	mm	kg/km	kg/km	m
0.5	1	0.26	0.8	0.9	6.99	9.6	175	180	0.8	5.2	35	37	1000
0.5	2	0.26	0.9	0.9	9.37	12.0	255	260	0.9	7.6	60	64	1000
0.5	4	0.26	0.9	0.9	10.54	13.4	315	320	0.9	8.8	89	97	1000
0.5	5	0.26	1.0	0.9	11.52	14.4	355	365	1.0	9.8	110	120	1000
0.5	6	0.26	1.0	0.9	12.35	15.2	395	405	1.0	10.6	125	135	1000
0.5	8	0.26	1.0	0.9	13.61	16.5	450	465	1.0	11.9	155	170	1000
0.5	10	0.26	1.1	0.9	15.34	18.4	530	550	1.1	13.6	195	215	1000
0.5	12	0.26	1.1	0.9	15.79	18.8	580	600	1.1	14.0	220	245	1000
0.5	16	0.26	1.1	0.9	17.29	20.3	660	690	1.1	15.5	280	305	1000
0.5	18	0.26	1.1	0.9	18.13	21.2	710	740	1.1	16.4	305	340	1000
0.5	19	0.26	1.1	0.9	18.13	21.2	720	760	1.1	16.4	320	355	1000
0.5	20	0.26	1.2	0.9	19.25	22.5	790	820	1.2	17.5	345	380	1000
0.5	24	0.26	1.2	1.25	21.82	25.1	1020	1060	1.2	19.4	405	445	1000
0.5	30	0.26	1.3	1.25	23.16	26.4	1150	1200	1.3	20.7	490	550	1000
0.5	37	0.26	1.3	1.25	24.81	28.3	1310	1380	1.3	22.4	590	650	1000
0.75	1	0.26	0.8	0.9	7.41	10.1	190	195	0.8	5.7	42	44	1000
0.75	2	0.26	0.9	0.9	10.05	12.9	290	295	0.9	8.3	73	78	1000
0.75	4	0.26	1.0	0.9	11.57	14.4	365	375	1.0	9.8	120	125	1000
0.75	5	0.26	1.0	0.9	12.45	15.3	410	420	1.0	10.7	140	150	1000
0.75	6	0.26	1.0	0.9	13.39	16.2	455	465	1.0	11.6	160	175	1000
0.75	8	0.26	1.1	0.9	15.00	18.0	540	560	1.1	13.2	210	225	1000
0.75	10	0.26	1.1	0.9	16.72	19.8	620	650	1.1	15.0	255	275	1000
0.75	12	0.26	1.1	0.9	17.22	20.3	680	700	1.1	15.5	290	315	1000
0.75	16	0.26	1.2	0.9	19.11	22.4	810	850	1.2	17.4	375	410	1000
0.75	18	0.26	1.2	1.25	20.75	24.0	1000	1040	1.2	18.3	415	455	1000
0.75	19	0.26	1.2	1.25	20.75	24.0	1020	1060	1.2	18.3	435	475	1000
0.75	20	0.26	1.2	1.25	21.79	25.0	1070	1110	1.2	19.3	455	500	1000
0.75	24	0.26	1.3	1.25	24.08	27.5	1240	1290	1.3	21.6	550	600	1000
0.75	30	0.26	1.4	1.25	25.57	29.0	1410	1470	1.4	23.1	670	730	1000
0.75	37	0.26	1.4	1.25	27.42	30.9	1600	1680	1.4	25.0	800	880	1000
1.0	1	0.26	0.8	0.9	7.77	10.4	205	210	0.8	6.0	49	51	1000
1.0	2	0.26	0.9	0.9	10.65	13.5	315	320	0.9	8.9	86	91	1000
1.0	4	0.26	1.0	0.9	12.28	15.1	405	415	1.0	10.5	145	150	1000
1.0	5	0.26	1.0	0.9	13.24	16.1	455	465	1.0	11.5	170	180	1000
1.0	6	0.26	1.0	0.9	14.27	17.1	510	520	1.0	12.5	195	210	1000
1.0	8	0.26	1.1	0.9	16.02	19.1	610	630	1.1	14.3	255	275	1000
1.0	10	0.26	1.1	0.9	17.90	20.9	710	740	1.1	16.1	310	335	1000
1.0	12	0.26	1.2	0.9	18.65	21.7	780	810	1.2	16.9	365	395	1000
1.0	16	0.26	1.2	1.25	21.20	24.4	1060	1100	1.2	18.7	465	510	1000
1.0	18	0.26	1.2	1.25	22.23	25.5	1140	1190	1.2	19.8	520	560	1000
1.0	19	0.26	1.2	1.25	22.23	25.5	1170	1210	1.2	19.8	540	590	1000
1.0	20	0.26	1.3	1.25	23.56	26.8	1250	1290	1.3	21.1	580	630	1000
1.0	24	0.26	1.3	1.25	25.86	29.3	1430	1490	1.3	23.4	680	740	1000
1.0	30	0.26	1.4	1.25	27.46	30.9	1630	1700	1.4	25.0	840	910	1000
1.0	37	0.26	1.5	1.25	29.68	33.3	1900	1990	1.5	27.2	1020	1110	500/1000
1.5	1	0.35	0.9	0.9	8.97	11.6	255	260	0.9	7.2	67	71	1000
1.5	2	0.35	1.0	0.9	12.49	15.3	390	400	1.0	10.7	120	130	1000
1.5	4	0.35	1.1	0.9	14.47	17.5	530	540	1.1	12.7	205	220	1000
1.5	5	0.35	1.1	0.9	15.66	18.7	590	610	1.1	13.9	245	260	1000
1.5	6	0.35	1.1	0.9	16.93	20.0	660	680	1.1	15.2	285	305	1000
1.5	8	0.35	1.2	0.9	19.04	22.3	810	830	1.2	17.3	370	400	1000
1.5	10	0.35	1.3	1.25	22.28	25.5	1090	1120	1.3	19.8	460	495	1000
1.5	12	0.35	1.3	1.25	22.96	26.4	1200	1240	1.3	20.5	530	580	1000
1.5	16	0.35	1.4	1.25	25.45	28.9	1430	1490	1.4	23.0	690	750	1000
1.5	18	0.35	1.4	1.25	26.73	30.2	1540	1610	1.4	24.3	770	830	1000
1.5	19	0.35	1.4	1.25	26.73	30.2	1580	1650	1.4	24.3	800	870	1000
1.5	20	0.35	1.5	1.25	28.33	32.0	1690	1770	1.5	25.9	850	930	500/1000
1.5	24	0.35	1.5	1.25	31.18	34.8	1930	2020	1.5	28.7	1010	1100	500/1000
1.5	30	0.35	1.6	1.6	33.82	37.7	2440	2550	1.6	30.7	1240	1350	500
1.5	37	0.35	1.7	1.6	36.52	40.6	2820	2960	1.7	33.4	1510	1640	500

For Cables of sizes or pairs not listed above the product data is available on request
Larger Drum Lengths are possible against specific requirements on request

• Dimensions & Weights are representative figures and may vary

Weight & Dimension Data

300 VOLTS, SINGLE AND MULTI TRIAD, STR.COPPER, PVC/PE INSULATED ALUMINIUM MYLAR TAPED OVERALL SHIELDED, ARMoured AND UNARMoured INSTRUMENTATION CABLES AS PER EN 50228

Area of conductor	No of triad	Minimum thickness of insulation	ARMoured CABLES						UNARMoured CABLES				Normal Drum Length with $\pm 5\%$
			Nominal thickness of inner sheath	Diameter of G.I. armour wire	Nominal thickness of outer sheath	Nominal overall diameter	Approx. weight - PE insulation	Approx. weight - PVC insulation	Nominal thickness of outer sheath	Nominal overall diameter	Approx. weight - PE insulation	Approx. weight - PVC insulation	
mm ²		mm	mm	mm	mm	mm	kg/km	kg/km	mm	mm	kg/km	kg/km	m
0.5	1	0.26	0.8	0.9	1.3	9.9	190	195	0.8	5.5	42	45	1000
0.5	2	0.26	0.9	0.9	1.3	12.8	285	290	0.9	8.4	76	81	1000
0.5	4	0.26	1.0	0.9	1.4	14.5	375	385	1.0	9.9	120	135	1000
0.5	5	0.26	1.0	0.9	1.4	15.4	415	430	1.0	10.8	145	160	1000
0.5	6	0.26	1.0	0.9	1.4	16.4	460	475	1.0	11.8	170	185	1000
0.5	8	0.26	1.1	0.9	1.5	18.2	560	580	1.1	13.4	220	240	1000
0.5	10	0.26	1.1	0.9	1.5	19.9	640	670	1.1	15.1	265	290	1000
0.5	12	0.26	1.1	0.9	1.5	20.4	690	720	1.1	15.6	300	335	1000
0.5	14	0.26	1.1	0.9	1.5	21.2	750	790	1.1	16.4	345	380	1000
0.5	16	0.26	1.2	0.9	1.6	22.6	840	880	1.2	17.6	390	435	1000
0.5	19	0.26	1.2	0.9	1.6	23.5	920	970	1.2	18.5	450	500	1000
0.5	20	0.26	1.2	1.25	1.6	25.3	1100	1160	1.2	19.6	475	530	1000
0.5	24	0.26	1.3	1.25	1.7	27.8	1280	1340	1.3	21.9	570	640	1000
0.5	30	0.26	1.3	1.25	1.7	29.1	1430	1510	1.3	23.2	690	770	1000
0.5	37	0.26	1.4	1.25	1.7	31.2	1640	1750	1.4	25.3	840	940	500/1000
0.75	1	0.26	0.8	0.9	1.3	10.4	210	210	0.8	6.0	52	55	1000
0.75	2	0.26	0.9	0.9	1.4	13.8	330	340	0.9	9.2	95	100	1000
0.75	4	0.26	1.0	0.9	1.4	15.5	430	440	1.0	10.9	160	170	1000
0.75	5	0.26	1.0	0.9	1.4	16.5	480	500	1.0	11.9	190	205	1000
0.75	6	0.26	1.1	0.9	1.5	18.0	560	580	1.1	13.2	225	245	1000
0.75	8	0.26	1.1	0.9	1.5	19.6	660	680	1.1	14.8	285	310	1000
0.75	10	0.26	1.2	0.9	1.5	21.7	770	810	1.2	16.9	355	390	1000
0.75	12	0.26	1.2	0.9	1.6	22.5	850	890	1.2	17.5	410	450	1000
0.75	14	0.26	1.2	1.25	1.6	24.1	1050	1100	1.2	18.4	470	510	1000
0.75	16	0.26	1.2	1.25	1.6	25.1	1150	1200	1.2	19.4	530	580	1000
0.75	19	0.26	1.3	1.25	1.6	26.4	1270	1330	1.3	20.7	620	680	1000
0.75	20	0.26	1.3	1.25	1.7	27.8	1360	1420	1.3	21.9	650	720	1000
0.75	24	0.26	1.4	1.25	1.7	30.4	1560	1640	1.4	24.5	780	860	1000
0.75	30	0.26	1.4	1.25	1.8	32.0	1780	1880	1.4	25.9	950	1040	500/1000
0.75	37	0.26	1.5	1.25	1.8	34.3	2060	2180	1.5	28.2	1150	1270	500/1000
1.0	1	0.26	0.9	0.9	1.3	10.9	235	240	0.9	6.5	64	68	1000
1.0	2	0.26	1.0	0.9	1.4	14.6	370	380	1.0	10.0	120	125	1000
1.0	4	0.26	1.0	0.9	1.4	16.3	485	500	1.0	11.7	195	205	1000
1.0	5	0.26	1.0	0.9	1.5	17.6	560	570	1.0	12.8	230	250	1000
1.0	6	0.26	1.1	0.9	1.5	18.9	630	650	1.1	14.1	280	300	1000
1.0	8	0.26	1.1	0.9	1.5	20.7	750	780	1.1	15.9	355	385	1000
1.0	10	0.26	1.2	0.9	1.6	23.2	900	940	1.2	18.2	440	480	1000
1.0	12	0.26	1.2	1.25	1.6	24.6	1110	1150	1.2	18.9	510	560	1000
1.0	14	0.26	1.3	1.25	1.6	25.7	1230	1280	1.3	20.0	590	640	1000
1.0	16	0.26	1.3	1.25	1.7	27.1	1350	1410	1.3	21.2	670	730	1000
1.0	19	0.26	1.3	1.25	1.7	28.2	1500	1560	1.3	22.3	780	840	1000
1.0	20	0.26	1.4	1.25	1.7	29.7	1590	1660	1.4	23.8	830	900	1000
1.0	24	0.26	1.4	1.25	1.8	32.5	1830	1920	1.4	26.4	980	1070	500/1000
1.0	30	0.26	1.5	1.25	1.8	34.3	2110	2220	1.5	28.2	1200	1310	500/1000
1.0	37	0.26	1.6	1.25	1.9	37.0	2470	2600	1.6	30.7	1470	1600	500
1.5	1	0.35	0.9	0.9	1.3	12.0	280	285	0.9	7.6	86	91	1000
1.5	2	0.35	1.0	0.9	1.4	16.5	455	465	1.0	11.9	160	170	1000
1.5	4	0.35	1.1	0.9	1.5	18.9	630	650	1.1	14.1	280	300	1000
1.5	5	0.35	1.1	0.9	1.5	20.3	720	750	1.1	15.5	335	365	1000
1.5	6	0.35	1.2	0.9	1.6	22.1	840	870	1.2	17.1	400	435	1000
1.5	8	0.35	1.3	1.25	1.6	25.2	1150	1190	1.3	19.5	520	570	1000
1.5	10	0.35	1.3	1.25	1.7	28.1	1350	1410	1.3	22.2	640	700	1000
1.5	12	0.35	1.4	1.25	1.7	29.1	1500	1560	1.4	23.2	760	820	1000
1.5	14	0.35	1.4	1.25	1.7	30.3	1640	1720	1.4	24.4	870	940	1000
1.5	16	0.35	1.5	1.25	1.8	32.1	1830	1910	1.5	26.0	990	1080	500/1000
1.5	19	0.35	1.5	1.25	1.8	33.5	2030	2140	1.5	27.4	1150	1250	500/1000
1.5	20	0.35	1.5	1.25	1.8	35.1	2140	2250	1.5	29.0	1210	1320	500/1000
1.5	24	0.35	1.7	1.6	2.0	39.8	2760	2890	1.7	32.6	1470	1600	500
1.5	30	0.35	1.7	1.6	2.0	41.8	3140	3310	1.7	34.6	1780	1950	500
1.5	37	0.35	1.8	1.6	2.1	45.1	3670	3880	1.8	37.7	2170	2380	500

For Cables of sizes or triads not listed above the product data is available on request
Larger Drum Lengths are possible against specific requirements on request

• Dimensions & Weights are representative figures and may vary

Weight & Dimension Data

300 VOLTS, MULTI PAIR, STR.COPPER, PVC/PE INSULATED ALUMINIUM MYLAR TAPED INDIVIDUAL AND OVERALL SHIELDED, ARMoured AND UNARMoured INSTRUMENTATION CABLES AS PER EN 50228

Area of conductor	No of pair	Minimum thickness of insulation	ARMoured CABLES						UNARMoured CABLES				Normal Drum Length with $\pm 5\%$
			Nominal thickness of inner sheath	Diameter of G.I. armour wire	Nominal thickness of outer sheath	Nominal overall diameter	Approx. weight - PE insulation	Approx. weight - PVC insulation	Nominal thickness of outer sheath	Nominal overall diameter	Approx. weight - PE insulation	Approx. weight - PVC insulation	
mm ²		mm	mm	mm	mm	mm	kg/km	kg/km	mm	mm	kg/km	kg/km	m
0.5	2	0.26	0.9	0.9	1.4	13.2	300	305	0.9	8.6	79	83	1000
0.5	4	0.26	1.0	0.9	1.4	14.8	385	390	1.0	10.2	130	135	1000
0.5	5	0.26	1.0	0.9	1.4	15.7	430	440	1.0	11.1	155	165	1000
0.5	6	0.26	1.0	0.9	1.4	16.7	480	490	1.0	12.1	180	190	1000
0.5	8	0.26	1.1	0.9	1.5	18.6	580	590	1.1	13.8	230	245	1000
0.5	10	0.26	1.1	0.9	1.5	20.4	670	680	1.1	15.6	280	300	1000
0.5	12	0.26	1.2	0.9	1.5	21.1	730	750	1.2	16.3	330	350	1000
0.5	16	0.26	1.2	1.25	1.6	23.8	1000	1030	1.2	18.1	420	445	1000
0.5	18	0.26	1.3	1.25	1.6	24.9	1080	1120	1.3	19.2	470	500	1000
0.5	19	0.26	1.3	1.25	1.6	24.9	1100	1140	1.3	19.2	490	530	1000
0.5	20	0.26	1.3	1.25	1.7	26.2	1170	1210	1.3	20.3	520	550	1000
0.5	24	0.26	1.4	1.25	1.7	28.6	1340	1390	1.4	22.7	620	660	1000
0.5	30	0.26	1.4	1.25	1.7	30.0	1510	1570	1.4	24.1	750	800	1000
0.5	37	0.26	1.5	1.25	1.8	32.3	1760	1830	1.5	26.2	910	980	500/1000
0.75	2	0.26	1.0	0.9	1.4	14.1	345	350	1.0	9.5	98	100	1000
0.75	4	0.26	1.0	0.9	1.4	15.7	435	440	1.0	11.1	155	165	1000
0.75	5	0.26	1.0	0.9	1.5	16.9	495	500	1.0	12.1	185	195	1000
0.75	6	0.26	1.1	0.9	1.5	18.2	560	570	1.1	13.4	225	235	1000
0.75	8	0.26	1.1	0.9	1.5	19.8	660	680	1.1	15.0	280	300	1000
0.75	10	0.26	1.2	0.9	1.6	22.3	790	810	1.2	17.3	350	370	1000
0.75	12	0.26	1.2	1.25	1.6	23.5	970	1000	1.2	17.8	405	430	1000
0.75	16	0.26	1.3	1.25	1.7	25.9	1180	1210	1.3	20.0	520	560	1000
0.75	18	0.26	1.3	1.25	1.7	27.0	1260	1300	1.3	21.1	580	620	1000
0.75	19	0.26	1.3	1.25	1.7	27.0	1290	1330	1.3	21.1	610	650	1000
0.75	20	0.26	1.4	1.25	1.7	28.4	1370	1410	1.4	22.5	650	690	1000
0.75	24	0.26	1.4	1.25	1.8	31.1	1570	1630	1.4	25.0	770	820	1000
0.75	30	0.26	1.5	1.25	1.8	32.8	1800	1870	1.5	26.7	940	1000	500/1000
0.75	37	0.26	1.6	1.25	1.9	35.3	2090	2170	1.6	29.0	1140	1220	500/1000
1.0	2	0.26	1.0	0.9	1.4	14.8	365	370	1.0	10.2	110	115	1000
1.0	4	0.26	1.0	0.9	1.4	16.5	475	485	1.0	11.9	180	190	1000
1.0	5	0.26	1.1	0.9	1.5	18.0	560	570	1.1	13.2	225	235	1000
1.0	6	0.26	1.1	0.9	1.5	19.2	620	640	1.1	14.4	260	275	1000
1.0	8	0.26	1.2	0.9	1.5	21.1	740	760	1.2	16.3	340	360	1000
1.0	10	0.26	1.2	1.25	1.6	24.2	1010	1030	1.2	18.5	415	435	1000
1.0	12	0.26	1.3	1.25	1.6	25.1	1100	1130	1.3	19.4	485	510	1000
1.0	16	0.26	1.3	1.25	1.7	27.4	1320	1350	1.3	21.5	620	660	1000
1.0	18	0.26	1.4	1.25	1.7	28.8	1440	1480	1.4	22.9	700	740	1000
1.0	19	0.26	1.4	1.25	1.7	28.8	1470	1510	1.4	22.9	730	780	1000
1.0	20	0.26	1.4	1.25	1.7	30.1	1540	1590	1.4	24.2	770	820	1000
1.0	24	0.26	1.5	1.25	1.8	33.2	1790	1850	1.5	27.1	920	980	500/1000
1.0	30	0.26	1.5	1.25	1.8	34.8	2040	2110	1.5	28.7	1120	1190	500/1000
1.0	37	0.26	1.6	1.6	1.9	38.3	2590	2670	1.6	31.3	1360	1450	500
1.5	2	0.35	1.0	0.9	1.5	16.8	450	460	1.0	12.0	145	155	1000
1.5	4	0.35	1.1	0.9	1.5	19.0	600	620	1.1	14.2	245	260	1000
1.5	5	0.35	1.2	0.9	1.5	20.6	700	720	1.2	15.8	305	325	1000
1.5	6	0.35	1.2	1.25	1.6	22.9	910	930	1.2	17.2	355	375	1000
1.5	8	0.35	1.3	1.25	1.7	25.5	1100	1130	1.3	19.6	460	490	1000
1.5	10	0.35	1.4	1.25	1.7	28.4	1300	1330	1.4	22.5	570	610	1000
1.5	12	0.35	1.4	1.25	1.7	29.2	1410	1460	1.4	23.3	660	710	1000
1.5	16	0.35	1.5	1.25	1.8	32.2	1700	1760	1.5	26.1	860	920	500/1000
1.5	18	0.35	1.5	1.25	1.8	33.6	1840	1910	1.5	27.5	960	1030	500/1000
1.5	19	0.35	1.5	1.25	1.8	33.6	1880	1950	1.5	27.5	1000	1070	500/1000
1.5	20	0.35	1.6	1.6	1.9	36.4	2230	2300	1.6	29.4	1070	1140	500
1.5	24	0.35	1.7	1.6	2.0	40.0	2570	2660	1.7	32.8	1280	1370	500
1.5	30	0.35	1.8	1.6	2.0	42.2	2950	3060	1.8	35.0	1560	1680	500
1.5	37	0.35	1.9	1.6	2.1	45.5	3420	3560	1.9	38.1	1900	2040	500

For Cables of sizes or pairs not listed above the product data is available on request
Larger Drum Lengths are possible against specific requirements on request

• Dimensions & Weights are representative figures and may vary

Weight & Dimension Data

300 VOLTS, MULTI TRIAD, STR.COPPER, PVC/PE INSULATED ALUMINIUM MYLAR TAPED INDIVIDUAL AND OVERALL SHIELDED, ARMoured AND UNARMoured INSTRUMENTATION CABLES AS PER EN 50228

Area of conductor	No of triad	Minimum thickness of insulation	ARMoured CABLES						UNARMoured CABLES				Normal Drum Length with $\pm 5\%$
			Nominal thickness of inner sheath	Diameter of G.I. armour wire	Nominal thickness of outer sheath	Nominal overall diameter	Approx. weight - PE insulation	Approx. weight - PVC insulation	Nominal thickness of outer sheath	Nominal overall diameter	Approx. weight - PE insulation	Approx. weight - PVC insulation	
mm ²		mm	mm	mm	mm	mm	kg/km	kg/km	mm	mm	kg/km	kg/km	m
0.5	2	0.26	1.0	0.9	1.4	14.3	345	350	1.0	9.7	100	105	1000
0.5	4	0.26	1.0	0.9	1.4	15.8	445	455	1.0	11.2	160	170	1000
0.5	5	0.26	1.0	0.9	1.4	16.9	495	510	1.0	12.3	190	205	1000
0.5	6	0.26	1.1	0.9	1.5	18.4	570	580	1.1	13.6	230	245	1000
0.5	8	0.26	1.1	0.9	1.5	20.1	670	690	1.1	15.3	290	310	1000
0.5	10	0.26	1.2	0.9	1.6	22.5	800	830	1.2	17.5	360	390	1000
0.5	12	0.26	1.2	1.25	1.6	23.8	1000	1030	1.2	18.1	415	450	1000
0.5	14	0.26	1.3	1.25	1.6	24.9	1090	1130	1.3	19.2	480	520	1000
0.5	16	0.26	1.3	1.25	1.7	26.2	1190	1240	1.3	20.3	540	580	1000
0.5	19	0.26	1.3	1.25	1.7	27.3	1320	1370	1.3	21.4	620	680	1000
0.5	20	0.26	1.4	1.25	1.7	28.8	1400	1460	1.4	22.9	670	720	1000
0.5	24	0.26	1.4	1.25	1.8	31.4	1610	1680	1.4	25.3	790	850	500/1000
0.5	30	0.26	1.5	1.25	1.8	33.2	1830	1920	1.5	27.1	960	1050	500/1000
0.5	37	0.26	1.6	1.25	1.9	35.8	2130	2230	1.6	29.5	1170	1280	500/1000
0.75	2	0.26	1.0	0.9	1.4	15.1	385	390	1.0	10.5	120	125	1000
0.75	4	0.26	1.0	0.9	1.5	17.1	510	520	1.0	12.3	195	210	1000
0.75	5	0.26	1.1	0.9	1.5	18.4	580	600	1.1	13.6	245	260	1000
0.75	6	0.26	1.1	0.9	1.5	19.7	650	670	1.1	14.9	285	305	1000
0.75	8	0.26	1.2	0.9	1.6	22.0	800	820	1.2	17.0	370	395	1000
0.75	10	0.26	1.3	1.25	1.6	25.1	1080	1120	1.3	19.4	460	490	1000
0.75	12	0.26	1.3	1.25	1.7	26.0	1180	1220	1.3	20.1	530	570	1000
0.75	14	0.26	1.3	1.25	1.7	27.0	1290	1330	1.3	21.1	610	650	1000
0.75	16	0.26	1.4	1.25	1.7	28.4	1410	1460	1.4	22.5	690	740	1000
0.75	19	0.26	1.4	1.25	1.7	29.7	1560	1620	1.4	23.8	800	860	1000
0.75	20	0.26	1.4	1.25	1.8	31.3	1650	1720	1.4	25.2	840	910	500/1000
0.75	24	0.26	1.5	1.25	1.8	34.2	1920	2000	1.5	28.1	1010	1090	500/1000
0.75	30	0.26	1.6	1.6	1.9	37.0	2420	2520	1.6	30.0	1240	1330	500
0.75	37	0.26	1.7	1.6	2.0	39.9	2800	2920	1.7	32.7	1510	1630	500
1.0	2	0.26	1.0	0.9	1.4	15.8	425	430	1.0	11.2	140	150	1000
1.0	4	0.26	1.1	0.9	1.5	18.1	580	590	1.1	13.3	240	255	1000
1.0	5	0.26	1.1	0.9	1.5	19.4	650	670	1.1	14.6	290	305	1000
1.0	6	0.26	1.2	0.9	1.5	21.0	750	770	1.2	16.2	345	365	1000
1.0	8	0.26	1.2	1.25	1.6	23.9	1020	1050	1.2	18.2	440	470	1000
1.0	10	0.26	1.3	1.25	1.7	26.8	1230	1260	1.3	20.9	550	590	1000
1.0	12	0.26	1.3	1.25	1.7	27.5	1330	1370	1.3	21.6	640	680	1000
1.0	14	0.26	1.4	1.25	1.7	28.8	1470	1520	1.4	22.9	740	790	1000
1.0	16	0.26	1.4	1.25	1.7	30.1	1600	1660	1.4	24.2	830	890	1000
1.0	19	0.26	1.5	1.25	1.8	31.9	1810	1880	1.5	25.8	980	1050	500/1000
1.0	20	0.26	1.5	1.25	1.8	33.4	1910	1980	1.5	27.3	1030	1100	500/1000
1.0	24	0.26	1.6	1.6	1.9	37.5	2440	2520	1.6	30.5	1230	1320	500
1.0	30	0.26	1.7	1.6	2.0	39.7	2800	2910	1.7	32.5	1510	1620	500
1.0	37	0.26	1.7	1.6	2.0	42.4	3210	3340	1.7	35.2	1830	1960	500
1.5	2	0.35	1.1	0.9	1.5	18.3	530	540	1.1	13.5	195	205	1000
1.5	4	0.35	1.2	0.9	1.5	20.8	730	750	1.2	16.0	330	355	1000
1.5	5	0.35	1.2	1.25	1.6	23.2	970	1000	1.2	17.5	400	430	1000
1.5	6	0.35	1.3	1.25	1.6	25.1	1090	1120	1.3	19.4	480	510	1000
1.5	8	0.35	1.4	1.25	1.7	28.0	1330	1380	1.4	22.1	620	670	1000
1.5	10	0.35	1.5	1.25	1.8	31.4	1600	1650	1.5	25.3	780	830	500/1000
1.5	12	0.35	1.5	1.25	1.8	32.3	1750	1820	1.5	26.2	900	970	500/1000
1.5	14	0.35	1.5	1.25	1.8	33.7	1920	2000	1.5	27.6	1030	1110	500/1000
1.5	16	0.35	1.6	1.6	1.9	36.4	2330	2420	1.6	29.4	1170	1260	500
1.5	19	0.35	1.6	1.6	1.9	38.0	2590	2690	1.6	31.0	1360	1470	500
1.5	20	0.35	1.7	1.6	2.0	40.3	2770	2880	1.7	33.1	1450	1560	500
1.5	24	0.35	1.8	1.6	2.1	44.4	3210	3340	1.8	37.0	1740	1870	500
1.5	30	0.35	1.9	1.6	2.1	46.8	3700	3860	1.9	39.4	2130	2300	500
1.5	37	0.35	2.0	2.0	2.2	51.3	4650	4850	2.0	42.9	2590	2800	500

For Cables of sizes or triads not listed above the product data is available on request
Larger Drum Lengths are possible against specific requirements on request

• Dimensions & Weights are representative figures and may vary

Weight & Dimension Data

500 VOLTS, MULTI CORE, STR.COPPER, PVC/PE INSULATED ALUMINIUM MYLAR TAPED OVERALL SHIELDED, ARMoured AND UNARMoured INSTRUMENTATION CABLES AS PER EN 50228

Area of conductor	No of core	Minimum thickness of insulation	ARMoured CABLES						UNARMoured CABLES				Normal Drum Length with $\pm 5\%$
			Nominal thickness of inner sheath	Diameter of G.I. armour wire	Nominal thickness of outer sheath	Nominal overall diameter	Approx. weight - PE insulation	Approx. weight - PVC insulation	Nominal thickness of outer sheath	Nominal overall diameter	Approx. weight - PE insulation	Approx. weight - PVC insulation	
mm ²		mm	mm	mm	mm	mm	kg/km	kg/km	mm	mm	kg/km	kg/km	m
0.5	2	0.44	0.9	0.9	1.3	10.6	215	215	0.9	6.2	48	52	1000
0.5	3	0.44	0.9	0.9	1.3	11.0	230	235	0.9	6.6	56	61	1000
0.5	4	0.44	0.9	0.9	1.3	11.5	255	260	0.9	7.1	67	73	1000
0.5	5	0.44	0.9	0.9	1.3	12.1	270	280	0.9	7.7	75	83	1000
0.5	6	0.44	0.9	0.9	1.4	12.9	305	315	0.9	8.3	87	97	1000
0.5	7	0.44	0.9	0.9	1.4	12.9	305	315	0.9	8.3	89	100	1000
0.5	8	0.44	1.0	0.9	1.4	14.1	345	360	1.0	9.5	105	120	1000
0.5	10	0.44	1.0	0.9	1.4	15.2	395	410	1.0	10.6	125	140	1000
0.5	12	0.44	1.0	0.9	1.4	15.6	420	435	1.0	11.0	140	160	1000
0.5	16	0.44	1.0	0.9	1.4	16.7	480	500	1.0	12.1	180	205	1000
0.5	18	0.44	1.1	0.9	1.5	17.7	530	560	1.1	12.9	205	235	1000
0.5	19	0.44	1.1	0.9	1.5	17.7	530	560	1.1	12.9	205	235	1000
0.5	20	0.44	1.1	0.9	1.5	18.4	570	600	1.1	13.6	225	260	1000
0.5	24	0.44	1.1	0.9	1.5	19.8	630	670	1.1	15.0	255	295	1000
0.5	30	0.44	1.2	0.9	1.5	20.9	710	760	1.2	16.1	310	360	1000
0.5	37	0.44	1.2	0.9	1.6	22.3	800	860	1.2	17.3	370	425	1000
0.75	2	0.44	0.9	0.9	1.3	11.1	230	235	0.9	6.7	57	60	1000
0.75	3	0.44	0.9	0.9	1.3	11.4	245	255	0.9	7.0	67	72	1000
0.75	4	0.44	0.9	0.9	1.3	12.0	275	285	0.9	7.6	81	88	1000
0.75	5	0.44	0.9	0.9	1.4	12.9	305	315	0.9	8.3	91	100	1000
0.75	6	0.44	0.9	0.9	1.4	13.6	340	350	0.9	9.0	110	120	1000
0.75	7	0.44	0.9	0.9	1.4	13.6	340	355	0.9	9.0	110	125	1000
0.75	8	0.44	1.0	0.9	1.4	14.8	390	405	1.0	10.2	130	145	1000
0.75	10	0.44	1.0	0.9	1.4	16.1	440	460	1.0	11.5	155	175	1000
0.75	12	0.44	1.0	0.9	1.4	16.4	470	495	1.0	11.8	180	200	1000
0.75	16	0.44	1.1	0.9	1.5	18.1	570	590	1.1	13.3	235	260	1000
0.75	18	0.44	1.1	0.9	1.5	18.8	610	640	1.1	14.0	260	295	1000
0.75	19	0.44	1.1	0.9	1.5	18.8	610	650	1.1	14.0	265	300	1000
0.75	20	0.44	1.1	0.9	1.5	19.5	660	690	1.1	14.7	290	325	1000
0.75	24	0.44	1.2	0.9	1.6	21.5	750	800	1.2	16.5	335	375	1000
0.75	30	0.44	1.2	1.25	1.6	23.1	960	1010	1.2	17.4	400	455	1000
0.75	37	0.44	1.3	1.25	1.6	24.7	1090	1160	1.3	19.0	485	550	1000
1.0	2	0.44	0.9	0.9	1.3	11.4	245	250	0.9	7.0	65	69	1000
1.0	3	0.44	0.9	0.9	1.3	11.8	265	270	0.9	7.4	78	84	1000
1.0	4	0.44	0.9	0.9	1.3	12.5	295	305	0.9	8.1	94	100	1000
1.0	5	0.44	0.9	0.9	1.4	13.4	330	340	0.9	8.8	105	115	1000
1.0	6	0.44	1.0	0.9	1.4	14.3	380	390	1.0	9.7	130	145	1000
1.0	7	0.44	1.0	0.9	1.4	14.3	385	395	1.0	9.7	135	150	1000
1.0	8	0.44	1.0	0.9	1.4	15.4	425	440	1.0	10.8	155	170	1000
1.0	10	0.44	1.0	0.9	1.4	16.8	490	510	1.0	12.2	185	205	1000

Weight & Dimension Data

500 VOLTS, MULTI CORE, STR.COPPER, PVC/PE INSULATED ALUMINIUM MYLAR TAPED OVERALL SHIELDED, ARMoured AND UNARMoured INSTRUMENTATION CABLES AS PER EN 50228

Area of conductor	No of core	Minimum thickness of insulation	ARMoured CABLES						UNARMoured CABLES				Normal Drum Length with \pm 5%
			Nominal thickness of inner sheath	Diameter of G.I. armour wire	Nominal thickness of outer sheath	Nominal overall diameter	Approx. weight - PE insulation	Approx. weight - PVC insulation	Nominal thickness of outer sheath	Nominal overall diameter	Approx. weight - PE insulation	Approx. weight - PVC insulation	
mm ²		mm	mm	mm	mm	mm	kg/km	kg/km	mm	mm	kg/km	kg/km	m
1.0	12	0.44	1.1	0.9	1.5	17.6	540	570	1.1	12.8	220	245	1000
1.0	16	0.44	1.1	0.9	1.5	18.9	640	670	1.1	14.1	280	315	1000
1.0	18	0.44	1.1	0.9	1.5	19.7	690	720	1.1	14.9	315	350	1000
1.0	19	0.44	1.1	0.9	1.5	19.7	690	730	1.1	14.9	320	360	1000
1.0	20	0.44	1.1	0.9	1.5	20.5	740	780	1.1	15.7	350	390	1000
1.0	24	0.44	1.2	0.9	1.6	22.6	850	900	1.2	17.6	405	455	1000
1.0	30	0.44	1.2	1.25	1.6	24.3	1080	1140	1.2	18.6	485	550	1000
1.0	37	0.44	1.3	1.25	1.6	26.0	1230	1310	1.3	20.3	590	670	1000
1.5	2	0.44	0.9	0.9	1.3	12.0	275	280	0.9	7.6	79	84	1000
1.5	3	0.44	0.9	0.9	1.4	12.7	305	315	0.9	8.1	97	105	1000
1.5	4	0.44	0.9	0.9	1.4	13.4	345	355	0.9	8.8	120	130	1000
1.5	5	0.44	1.0	0.9	1.4	14.4	390	400	1.0	9.8	140	155	1000
1.5	6	0.44	1.0	0.9	1.4	15.2	435	450	1.0	10.6	170	180	1000
1.5	7	0.44	1.0	0.9	1.4	15.2	445	460	1.0	10.6	175	195	1000
1.5	8	0.44	1.0	0.9	1.4	16.5	495	510	1.0	11.9	200	220	1000
1.5	10	0.44	1.1	0.9	1.5	18.4	590	610	1.1	13.6	250	275	1000
1.5	12	0.44	1.1	0.9	1.5	18.8	640	670	1.1	14.0	285	315	1000
1.5	16	0.44	1.2	0.9	1.5	20.5	770	810	1.2	15.7	380	415	1000
1.5	18	0.44	1.2	0.9	1.6	21.6	840	880	1.2	16.6	420	465	1000
1.5	19	0.44	1.2	0.9	1.6	21.6	850	890	1.2	16.6	430	475	1000
1.5	20	0.44	1.2	1.25	1.6	23.2	1040	1080	1.2	17.5	470	520	1000
1.5	24	0.44	1.3	1.25	1.6	25.3	1170	1220	1.3	19.6	540	600	1000
1.5	30	0.44	1.3	1.25	1.7	26.6	1320	1390	1.3	20.7	660	730	1000
1.5	37	0.44	1.4	1.25	1.7	28.5	1520	1610	1.4	22.6	800	890	1000
2.5	2	0.53	1.0	0.9	1.4	13.6	345	350	1.0	9.0	115	120	1000
2.5	3	0.53	1.0	0.9	1.4	14.2	385	395	1.0	9.6	140	150	1000
2.5	4	0.53	1.0	0.9	1.4	15.1	435	450	1.0	10.5	175	190	1000
2.5	5	0.53	1.0	0.9	1.4	16.0	485	500	1.0	11.4	200	220	1000
2.5	6	0.53	1.1	0.9	1.5	17.4	570	590	1.1	12.6	245	265	1000
2.5	7	0.53	1.1	0.9	1.5	17.4	580	610	1.1	12.6	260	285	1000
2.5	8	0.53	1.1	0.9	1.5	19.0	650	680	1.1	14.2	295	325	1000
2.5	10	0.53	1.2	0.9	1.6	21.2	780	820	1.2	16.2	370	405	1000
2.5	12	0.53	1.2	0.9	1.6	21.8	850	890	1.2	16.8	430	470	1000
2.5	16	0.53	1.3	1.25	1.6	24.5	1160	1220	1.3	18.8	560	620	1000
2.5	18	0.53	1.3	1.25	1.7	25.7	1270	1330	1.3	19.8	630	690	1000
2.5	19	0.53	1.3	1.25	1.7	25.7	1290	1350	1.3	19.8	650	710	1000
2.5	20	0.53	1.3	1.25	1.7	26.9	1380	1450	1.3	21.0	700	770	1000
2.5	24	0.53	1.4	1.25	1.7	29.3	1570	1650	1.4	23.4	820	900	1000
2.5	30	0.53	1.5	1.25	1.8	31.1	1810	1910	1.5	25.0	1010	1110	1000
2.5	37	0.53	1.5	1.25	1.8	33.1	2080	2200	1.5	27.0	1210	1330	500/1000

For Cables of sizes or cores not listed above the product data is available on request
Larger Drum Lengths are possible against specific requirements on request

• Dimensions & Weights are representative figures and may vary

Weight & Dimension Data



500 VOLTS, SINGLE AND MULTI PAIR, STR. COPPER, PVC/PE INSULATED ALUMINIUM MYLAR TAPED OVERALL SHIELDED, ARMoured AND UNARMoured INSTRUMENTATION CABLES AS PER EN 50228

Area of conductor	No of pair	Minimum thickness of insulation	ARMoured CABLES						UNARMoured CABLES				Normal Drum Length with \pm 5%
			Nominal thickness of inner sheath	Diameter of G.I. armour wire	Nominal thickness of outer sheath	Nominal overall diameter	Approx. weight - PE insulation	Approx. weight - PVC insulation	Nominal thickness of outer sheath	Nominal overall diameter	Approx. weight - PE insulation	Approx. weight - PVC insulation	
mm ²		mm	mm	mm	mm	mm	kg/km	kg/km	mm	mm	kg/km	kg/km	m
0.5	1	0.44	0.9	0.9	1.3	10.6	210	210	0.9	6.2	44	47	1000
0.5	2	0.44	0.9	0.9	1.4	13.5	300	310	0.9	8.9	71	77	1000
0.5	4	0.44	1.0	0.9	1.4	15.2	380	390	1.0	10.6	110	125	1000
0.5	5	0.44	1.0	0.9	1.4	16.1	415	430	1.0	11.5	130	145	1000
0.5	6	0.44	1.1	0.9	1.5	17.6	480	500	1.1	12.8	155	175	1000
0.5	8	0.44	1.1	0.9	1.5	19.1	550	570	1.1	14.3	195	220	1000
0.5	10	0.44	1.2	0.9	1.5	21.2	650	680	1.2	16.4	240	270	1000
0.5	12	0.44	1.2	0.9	1.6	22.0	700	740	1.2	17.0	275	310	1000
0.5	16	0.44	1.2	1.25	1.6	24.5	940	990	1.2	18.8	340	390	1000
0.5	18	0.44	1.3	1.25	1.6	25.8	1020	1080	1.3	20.1	385	445	1000
0.5	19	0.44	1.3	1.25	1.6	25.8	1040	1100	1.3	20.1	400	460	1000
0.5	20	0.44	1.3	1.25	1.7	27.1	1100	1170	1.3	21.2	420	485	1000
0.5	24	0.44	1.4	1.25	1.7	29.6	1260	1330	1.4	23.7	510	580	1000
0.5	30	0.44	1.4	1.25	1.8	31.2	1410	1510	1.4	25.1	600	700	500/1000
0.5	37	0.44	1.5	1.25	1.8	33.4	1610	1730	1.5	27.3	730	850	500/1000
0.75	1	0.44	0.9	0.9	1.3	11.1	225	225	0.9	6.7	51	55	1000
0.75	2	0.44	1.0	0.9	1.4	14.4	335	345	1.0	9.8	89	97	1000
0.75	4	0.44	1.0	0.9	1.4	16.0	420	435	1.0	11.4	135	150	1000
0.75	5	0.44	1.1	0.9	1.5	17.5	490	510	1.1	12.7	170	185	1000
0.75	6	0.44	1.1	0.9	1.5	18.6	540	560	1.1	13.8	195	215	1000
0.75	8	0.44	1.2	0.9	1.5	20.5	640	670	1.2	15.7	250	280	1000
0.75	10	0.44	1.2	1.25	1.6	23.5	870	910	1.2	17.8	305	340	1000
0.75	12	0.44	1.2	1.25	1.6	24.1	930	970	1.2	18.4	345	390	1000
0.75	16	0.44	1.3	1.25	1.7	26.5	1110	1170	1.3	20.6	445	500	1000
0.75	18	0.44	1.3	1.25	1.7	27.7	1190	1250	1.3	21.8	495	560	1000
0.75	19	0.44	1.3	1.25	1.7	27.7	1210	1280	1.3	21.8	510	580	1000
0.75	20	0.44	1.4	1.25	1.7	29.1	1290	1360	1.4	23.2	550	620	1000
0.75	24	0.44	1.5	1.25	1.8	32.1	1500	1590	1.5	26.0	660	750	500/1000
0.75	30	0.44	1.5	1.25	1.8	33.6	1670	1780	1.5	27.5	790	900	500/1000
0.75	37	0.44	1.6	1.6	1.9	37.0	2140	2270	1.6	30.0	960	1090	500
1.0	1	0.44	0.9	0.9	1.3	11.4	240	240	0.9	7.0	58	62	1000
1.0	2	0.44	1.0	0.9	1.4	15.0	365	375	1.0	10.4	105	110	1000
1.0	4	0.44	1.0	0.9	1.4	16.7	460	480	1.0	12.1	160	180	1000
1.0	5	0.44	1.1	0.9	1.5	18.3	540	560	1.1	13.5	200	220	1000
1.0	6	0.44	1.1	0.9	1.5	19.5	590	620	1.1	14.7	230	255	1000
1.0	8	0.44	1.2	0.9	1.5	21.5	710	740	1.2	16.7	300	330	1000
1.0	10	0.44	1.2	1.25	1.6	24.7	970	1010	1.2	19.0	365	405	1000
1.0	12	0.44	1.3	1.25	1.6	25.5	1050	1100	1.3	19.8	425	475	1000
1.0	16	0.44	1.3	1.25	1.7	27.9	1250	1310	1.3	22.0	540	610	1000

Weight & Dimension Data

500 VOLTS, SINGLE AND MULTI PAIR, STR. COPPER, PVC/PE INSULATED ALUMINIUM MYLAR TAPED OVERALL SHIELDED, ARMoured AND UNARMoured INSTRUMENTATION CABLES AS PER EN 50228

Area of conductor	No of pair	Minimum thickness of insulation	ARMoured CABLES						UNARMoured CABLES				Normal Drum Length with $\pm 5\%$
			Nominal thickness of inner sheath	Diameter of G.I. armour wire	Nominal thickness of outer sheath	Nominal overall diameter	Approx. weight - PE insulation	Approx. weight - PVC insulation	Nominal thickness of outer sheath	Nominal overall diameter	Approx. weight - PE insulation	Approx. weight - PVC insulation	
mm ²		mm	mm	mm	mm	mm	kg/km	kg/km	mm	mm	kg/km	kg/km	m
1.0	18	0.44	1.4	1.25	1.7	29.4	1360	1430	1.4	23.5	610	680	1000
1.0	19	0.44	1.4	1.25	1.7	29.4	1390	1460	1.4	23.5	640	710	1000
1.0	20	0.44	1.4	1.25	1.8	30.9	1480	1560	1.4	24.8	670	750	1000
1.0	24	0.44	1.5	1.25	1.8	33.8	1700	1790	1.5	27.7	800	900	500/1000
1.0	30	0.44	1.6	1.25	1.9	35.9	1950	2070	1.6	29.6	980	1100	500/1000
1.0	37	0.44	1.6	1.6	1.9	39.0	2420	2570	1.6	32.0	1170	1320	500
1.5	1	0.44	0.9	0.9	1.3	12.0	265	270	0.9	7.6	71	76	1000
1.5	2	0.44	1.0	0.9	1.4	16.0	415	420	1.0	11.4	130	135	1000
1.5	4	0.44	1.1	0.9	1.5	18.3	550	570	1.1	13.5	215	235	1000
1.5	5	0.44	1.1	0.9	1.5	19.6	630	650	1.1	14.8	255	280	1000
1.5	6	0.44	1.2	0.9	1.5	21.2	710	740	1.2	16.4	305	335	1000
1.5	8	0.44	1.2	1.25	1.6	24.1	970	1010	1.2	18.4	390	425	1000
1.5	10	0.44	1.3	1.25	1.7	27.0	1170	1210	1.3	21.1	485	530	1000
1.5	12	0.44	1.3	1.25	1.7	27.8	1270	1320	1.3	21.9	560	620	1000
1.5	16	0.44	1.4	1.25	1.8	30.6	1520	1600	1.4	24.5	730	800	1000
1.5	18	0.44	1.5	1.25	1.8	32.2	1660	1740	1.5	26.1	820	900	500/1000
1.5	19	0.44	1.5	1.25	1.8	32.2	1690	1780	1.5	26.1	850	940	500/1000
1.5	20	0.44	1.5	1.25	1.8	33.7	1790	1890	1.5	27.6	900	990	500/1000
1.5	24	0.44	1.6	1.6	1.9	37.9	2280	2400	1.6	30.9	1080	1190	500
1.5	30	0.44	1.7	1.6	2.0	40.2	2630	2770	1.7	33.0	1320	1460	500
1.5	37	0.44	1.8	1.6	2.0	43.1	3010	3180	1.8	35.9	1600	1770	500
2.5	1	0.53	1.0	0.9	1.4	13.6	330	340	1.0	9.0	100	105	1000
2.5	2	0.53	1.1	0.9	1.5	18.4	520	540	1.1	13.6	185	200	1000
2.5	4	0.53	1.2	0.9	1.6	21.1	730	750	1.2	16.1	315	340	1000
2.5	5	0.53	1.2	1.25	1.6	23.4	950	980	1.2	17.7	380	415	1000
2.5	6	0.53	1.3	1.25	1.7	25.5	1090	1130	1.3	19.6	455	495	1000
2.5	8	0.53	1.4	1.25	1.7	28.2	1300	1350	1.4	22.3	590	640	1000
2.5	10	0.53	1.5	1.25	1.8	31.6	1560	1620	1.5	25.5	730	800	500/1000
2.5	12	0.53	1.5	1.25	1.8	32.5	1700	1780	1.5	26.4	850	930	500/1000
2.5	16	0.53	1.6	1.6	1.9	36.6	2270	2370	1.6	29.6	1100	1210	500
2.5	18	0.53	1.7	1.6	2.0	38.7	2490	2610	1.7	31.5	1240	1360	500
2.5	19	0.53	1.7	1.6	2.0	38.7	2540	2670	1.7	31.5	1300	1420	500
2.5	20	0.53	1.7	1.6	2.0	40.6	2680	2820	1.7	33.4	1370	1500	500
2.5	24	0.53	1.9	1.6	2.1	44.9	3150	3310	1.9	37.5	1650	1810	500
2.5	30	0.53	1.9	1.6	2.2	47.4	3610	3810	1.9	39.8	2000	2200	500
2.5	37	0.53	2.1	2.0	2.3	52.1	4570	4810	2.1	43.5	2460	2700	500

For Cables of sizes or pairs not listed above the product data is available on request
Larger Drum Lengths are possible against specific requirements on request

• Dimensions & Weights are representative figures and may vary

Weight & Dimension Data

500 VOLTS, SINGLE AND MULTI TRIAD, STR. COPPER, PVC/PE INSULATED ALUMINIUM MYLAR TAPED OVERALL SHIELDED, ARMoured AND UNARMoured INSTRUMENTATION CABLES AS PER EN 50228

Area of conductor	No of triad	Minimum thickness of insulation	ARMoured CABLES						UNARMoured CABLES				Normal Drum Length with $\pm 5\%$
			Nominal thickness of inner sheath	Diameter of G.I. armour wire	Nominal thickness of outer sheath	Nominal overall diameter	Approx. weight - PE insulation	Approx. weight - PVC insulation	Nominal thickness of outer sheath	Nominal overall diameter	Approx. weight - PE insulation	Approx. weight - PVC insulation	
mm ²		mm	mm	mm	mm	mm	kg/km	kg/km	mm	mm	kg/km	kg/km	m
0.5	1	0.44	0.9	0.9	1.3	11.0	225	230	0.9	6.6	52	57	1000
0.5	2	0.44	1.0	0.9	1.4	14.7	350	360	1.0	10.1	94	105	1000
0.5	4	0.44	1.0	0.9	1.4	16.3	440	455	1.0	11.7	145	165	1000
0.5	5	0.44	1.1	0.9	1.5	17.8	510	530	1.1	13.0	180	205	1000
0.5	6	0.44	1.1	0.9	1.5	19.0	560	590	1.1	14.2	205	235	1000
0.5	8	0.44	1.2	0.9	1.5	21.0	670	710	1.2	16.2	270	305	1000
0.5	10	0.44	1.2	1.25	1.6	24.0	910	960	1.2	18.3	325	370	1000
0.5	12	0.44	1.3	1.25	1.6	24.9	990	1050	1.3	19.2	380	435	1000
0.5	14	0.44	1.3	1.25	1.7	26.1	1080	1150	1.3	20.2	430	495	1000
0.5	16	0.44	1.3	1.25	1.7	27.2	1160	1240	1.3	21.3	480	560	1000
0.5	19	0.44	1.4	1.25	1.7	28.6	1290	1380	1.4	22.7	560	650	1000
0.5	20	0.44	1.4	1.25	1.7	29.9	1360	1450	1.4	24.0	590	690	1000
0.5	24	0.44	1.5	1.25	1.8	32.9	1580	1690	1.5	26.8	710	820	500/1000
0.5	30	0.44	1.5	1.25	1.8	34.5	1760	1900	1.5	28.4	850	990	500/1000
0.5	37	0.44	1.6	1.6	1.9	37.9	2240	2420	1.6	30.9	1030	1210	500
0.75	1	0.44	0.9	0.9	1.3	11.4	245	250	0.9	7.0	63	68	1000
0.75	2	0.44	1.0	0.9	1.4	15.5	385	395	1.0	10.9	115	125	1000
0.75	4	0.44	1.1	0.9	1.5	17.7	510	530	1.1	12.9	190	210	1000
0.75	5	0.44	1.1	0.9	1.5	18.9	580	610	1.1	14.1	225	250	1000
0.75	6	0.44	1.1	0.9	1.5	20.2	650	680	1.1	15.4	260	295	1000
0.75	8	0.44	1.2	1.25	1.6	23.2	910	950	1.2	17.5	340	385	1000
0.75	10	0.44	1.3	1.25	1.7	26.0	1070	1130	1.3	20.1	425	475	1000
0.75	12	0.44	1.3	1.25	1.7	26.7	1150	1220	1.3	20.8	485	550	1000
0.75	14	0.44	1.3	1.25	1.7	27.8	1260	1340	1.3	21.9	550	630	1000
0.75	16	0.44	1.4	1.25	1.7	29.2	1380	1470	1.4	23.3	630	720	1000
0.75	19	0.44	1.4	1.25	1.8	30.7	1520	1630	1.4	24.6	730	830	1000
0.75	20	0.44	1.5	1.25	1.8	32.3	1630	1740	1.5	26.2	780	890	500/1000
0.75	24	0.44	1.6	1.25	1.9	35.6	1890	2020	1.6	29.3	930	1060	500/1000
0.75	30	0.44	1.6	1.6	1.9	38.1	2350	2510	1.6	31.1	1120	1290	500
0.75	37	0.44	1.7	1.6	2.0	41.0	2700	2900	1.7	33.8	1370	1570	500
1.0	1	0.44	0.9	0.9	1.3	11.8	260	265	0.9	7.4	72	78	1000
1.0	2	0.44	1.0	0.9	1.4	16.1	420	430	1.0	11.5	135	145	1000
1.0	4	0.44	1.1	0.9	1.5	18.5	570	600	1.1	13.7	225	250	1000
1.0	5	0.44	1.1	0.9	1.5	19.8	640	670	1.1	15.0	270	300	1000
1.0	6	0.44	1.2	0.9	1.5	21.4	730	770	1.2	16.6	325	360	1000
1.0	8	0.44	1.2	1.25	1.6	24.4	1010	1060	1.2	18.7	410	460	1000
1.0	10	0.44	1.3	1.25	1.7	27.3	1210	1270	1.3	21.4	510	570	1000
1.0	12	0.44	1.3	1.25	1.7	28.1	1300	1370	1.3	22.2	590	660	1000
1.0	14	0.44	1.4	1.25	1.7	29.5	1440	1520	1.4	23.6	690	770	1000

Weight & Dimension Data

500 VOLTS, SINGLE AND MULTI TRIAD, STR. COPPER, PVC/PE INSULATED ALUMINIUM MYLAR TAPED OVERALL SHIELDED, ARMoured AND UNARMoured INSTRUMENTATION CABLES AS PER EN 50228

Area of conductor	No of triad	Minimum thickness of insulation	ARMoured CABLES						UNARMoured CABLES				Normal Drum Length with \pm 5%
			Nominal thickness of inner sheath	Diameter of G.I. armour wire	Nominal thickness of outer sheath	Nominal overall diameter	Approx. weight - PE insulation	Approx. weight - PVC insulation	Nominal thickness of outer sheath	Nominal overall diameter	Approx. weight - PE insulation	Approx. weight - PVC insulation	
mm ²		mm	mm	mm	mm	mm	kg/km	kg/km	mm	mm	kg/km	kg/km	m
1.0	16	0.44	1.4	1.25	1.8	31.0	1580	1670	1.4	24.9	770	870	1000
1.0	19	0.44	1.5	1.25	1.8	32.6	1760	1870	1.5	26.5	910	1020	500/1000
1.0	20	0.44	1.5	1.25	1.8	34.1	1850	1970	1.5	28.0	950	1070	500/1000
1.0	24	0.44	1.6	1.6	1.9	38.4	2370	2510	1.6	31.4	1140	1290	500
1.0	30	0.44	1.7	1.6	2.0	40.7	2730	2910	1.7	33.5	1400	1580	500
1.0	37	0.44	1.8	1.6	2.0	43.6	3130	3350	1.8	36.4	1700	1920	500
1.5	1	0.44	0.9	0.9	1.4	12.7	300	305	0.9	8.1	90	97	1000
1.5	2	0.44	1.1	0.9	1.5	17.7	500	510	1.1	12.9	175	190	1000
1.5	4	0.44	1.1	0.9	1.5	19.9	670	700	1.1	15.1	295	320	1000
1.5	5	0.44	1.2	0.9	1.6	21.7	780	820	1.2	16.7	360	395	1000
1.5	6	0.44	1.2	1.25	1.6	24.0	1010	1050	1.2	18.3	425	465	1000
1.5	8	0.44	1.3	1.25	1.7	26.7	1220	1280	1.3	20.8	550	610	1000
1.5	10	0.44	1.4	1.25	1.7	29.8	1450	1520	1.4	23.9	690	760	1000
1.5	12	0.44	1.4	1.25	1.8	30.8	1610	1690	1.4	24.7	800	880	1000
1.5	14	0.44	1.5	1.25	1.8	32.3	1780	1870	1.5	26.2	920	1020	500/1000
1.5	16	0.44	1.5	1.25	1.8	33.8	1940	2050	1.5	27.7	1040	1150	500/1000
1.5	19	0.44	1.6	1.6	1.9	36.5	2380	2520	1.6	29.5	1220	1360	500
1.5	20	0.44	1.6	1.6	1.9	38.2	2520	2660	1.6	31.2	1290	1430	500
1.5	24	0.44	1.8	1.6	2.0	42.3	2940	3110	1.8	35.1	1560	1730	500
1.5	30	0.44	1.8	1.6	2.1	44.7	3390	3600	1.8	37.3	1890	2100	500
1.5	37	0.44	1.9	1.6	2.2	48.1	3940	4200	1.9	40.5	2310	2560	500
2.5	1	0.53	1.0	0.9	1.4	14.2	375	385	1.0	9.6	130	140	1000
2.5	2	0.53	1.2	0.9	1.5	20.1	630	650	1.2	15.3	255	275	1000
2.5	4	0.53	1.2	1.25	1.6	23.7	1020	1060	1.2	18.0	435	475	1000
2.5	5	0.53	1.3	1.25	1.7	25.9	1190	1240	1.3	20.0	540	590	1000
2.5	6	0.53	1.4	1.25	1.7	28.0	1350	1410	1.4	22.1	640	700	1000
2.5	8	0.53	1.5	1.25	1.8	31.2	1650	1730	1.5	25.1	840	920	500/1000
2.5	10	0.53	1.6	1.6	1.9	35.8	2180	2280	1.6	28.8	1040	1140	500/1000
2.5	12	0.53	1.6	1.6	1.9	36.8	2400	2520	1.6	29.8	1220	1340	500
2.5	14	0.53	1.7	1.6	2.0	38.8	2670	2810	1.7	31.6	1410	1550	500
2.5	16	0.53	1.7	1.6	2.0	40.7	2920	3080	1.7	33.5	1590	1750	500
2.5	19	0.53	1.8	1.6	2.1	43.0	3290	3480	1.8	35.6	1870	2060	500
2.5	20	0.53	1.9	1.6	2.1	45.3	3500	3700	1.9	37.9	1990	2190	500
2.5	24	0.53	2.0	2.0	2.3	50.9	4420	4660	2.0	42.3	2370	2610	500
2.5	30	0.53	2.1	2.0	2.3	53.7	5090	5390	2.1	45.1	2910	3210	500
2.5	37	0.53	2.2	2.0	2.4	57.9	5930	6300	2.2	49.1	3550	3920	500

For Cables of sizes or triads not listed above the product data is available on request
Larger Drum Lengths are possible against specific requirements on request

• Dimensions & Weights are representative figures and may vary

Weight & Dimension Data

500 VOLTS, MULTI PAIR, STR. COPPER, PVC/PE INSULATED ALUMINIUM MYLAR TAPED INDIVIDUAL AND OVERALL SHIELDED, ARMoured AND UNARMoured INSTRUMENTATION CABLES AS PER EN 50228

Area of conductor	No of pair	Minimum thickness of insulation	ARMoured CABLES						UNARMoured CABLES				Normal Drum Length with $\pm 5\%$
			Nominal thickness of inner sheath	Diameter of G.I. armour wire	Nominal thickness of outer sheath	Nominal overall diameter	Approx. weight - PE insulation	Approx. weight - PVC insulation	Nominal thickness of outer sheath	Nominal overall diameter	Approx. weight - PE insulation	Approx. weight - PVC insulation	
mm ²		mm	mm	mm	mm	mm	kg/km	kg/km	mm	mm	kg/km	kg/km	m
0.5	2	0.44	1.0	0.9	1.4	14.8	355	365	1.0	10.2	97	105	1000
0.5	4	0.44	1.0	0.9	1.5	16.7	450	465	1.0	11.9	150	165	1000
0.5	5	0.44	1.1	0.9	1.5	18.0	520	530	1.1	13.2	185	200	1000
0.5	6	0.44	1.1	0.9	1.5	19.2	580	590	1.1	14.4	215	235	1000
0.5	8	0.44	1.2	0.9	1.6	21.4	690	710	1.2	16.4	275	300	1000
0.5	10	0.44	1.3	1.25	1.6	24.5	940	970	1.3	18.8	345	375	1000
0.5	12	0.44	1.3	1.25	1.7	25.3	1030	1070	1.3	19.4	390	430	1000
0.5	16	0.44	1.4	1.25	1.7	27.7	1200	1250	1.4	21.8	510	560	1000
0.5	18	0.44	1.4	1.25	1.7	28.9	1300	1350	1.4	23.0	560	620	1000
0.5	19	0.44	1.4	1.25	1.7	28.9	1320	1380	1.4	23.0	580	640	1000
0.5	20	0.44	1.4	1.25	1.8	30.4	1410	1470	1.4	24.3	610	680	1000
0.5	24	0.44	1.5	1.25	1.8	33.3	1610	1690	1.5	27.2	730	810	500/1000
0.5	30	0.44	1.6	1.6	1.9	36.0	2030	2130	1.6	29.0	890	990	500
0.5	37	0.44	1.7	1.6	2.0	38.8	2330	2450	1.7	31.6	1080	1200	500
0.75	2	0.44	1.0	0.9	1.4	15.6	390	395	1.0	11.0	110	120	1000
0.75	4	0.44	1.1	0.9	1.5	17.8	510	530	1.1	13.0	185	200	1000
0.75	5	0.44	1.1	0.9	1.5	19.0	570	590	1.1	14.2	220	235	1000
0.75	6	0.44	1.2	0.9	1.5	20.5	650	680	1.2	15.7	260	285	1000
0.75	8	0.44	1.2	1.25	1.6	23.4	900	930	1.2	17.7	330	360	1000
0.75	10	0.44	1.3	1.25	1.7	26.2	1060	1100	1.3	20.3	410	445	1000
0.75	12	0.44	1.3	1.25	1.7	26.9	1150	1190	1.3	21.0	470	510	1000
0.75	16	0.44	1.4	1.25	1.8	29.7	1370	1430	1.4	23.6	610	670	1000
0.75	18	0.44	1.5	1.25	1.8	31.2	1500	1560	1.5	25.1	690	750	500/1000
0.75	19	0.44	1.5	1.25	1.8	31.2	1520	1590	1.5	25.1	710	780	500/1000
0.75	20	0.44	1.5	1.25	1.8	32.6	1610	1680	1.5	26.5	750	830	500/1000
0.75	24	0.44	1.6	1.6	1.9	36.6	2060	2150	1.6	29.6	900	990	500
0.75	30	0.44	1.7	1.6	2.0	38.8	2360	2470	1.7	31.6	1100	1210	500
0.75	37	0.44	1.8	1.6	2.0	41.6	2690	2830	1.8	34.4	1330	1470	500
1.0	2	0.44	1.0	0.9	1.4	16.2	420	425	1.0	11.6	125	135	1000
1.0	4	0.44	1.1	0.9	1.5	18.6	560	570	1.1	13.8	210	225	1000
1.0	5	0.44	1.1	0.9	1.5	19.9	630	650	1.1	15.1	250	270	1000
1.0	6	0.44	1.2	0.9	1.6	21.7	720	750	1.2	16.7	300	325	1000
1.0	8	0.44	1.3	1.25	1.6	24.7	1000	1030	1.3	19.0	390	420	1000
1.0	10	0.44	1.3	1.25	1.7	27.5	1170	1210	1.3	21.6	475	510	1000
1.0	12	0.44	1.4	1.25	1.7	28.4	1280	1330	1.4	22.5	560	610	1000
1.0	16	0.44	1.5	1.25	1.8	31.4	1540	1610	1.5	25.3	720	790	500/1000

Weight & Dimension Data

500 VOLTS, MULTI PAIR, STR. COPPER, PVC/PE INSULATED ALUMINIUM MYLAR TAPED INDIVIDUAL AND OVERALL SHIELDED, ARMoured AND UNARMoured INSTRUMENTATION CABLES AS PER EN 50228

Area of conductor	No of pair	Minimum thickness of insulation	ARMoured CABLES						UNARMoured CABLES				Normal Drum Length with $\pm 5\%$
			Nominal thickness of inner sheath	Diameter of G.I. armour wire	Nominal thickness of outer sheath	Nominal overall diameter	Approx. weight - PE insulation	Approx. weight - PVC insulation	Nominal thickness of outer sheath	Nominal overall diameter	Approx. weight - PE insulation	Approx. weight - PVC insulation	
mm ²		mm	mm	mm	mm	mm	kg/km	kg/km	mm	mm	kg/km	kg/km	m
1.0	18	0.44	1.5	1.25	1.8	32.8	1660	1740	1.5	26.7	800	870	500/1000
1.0	19	0.44	1.5	1.25	1.8	32.8	1700	1770	1.5	26.7	830	910	500/1000
1.0	20	0.44	1.6	1.25	1.9	34.7	1820	1900	1.6	28.4	890	970	500/1000
1.0	24	0.44	1.7	1.6	2.0	38.9	2330	2430	1.7	31.7	1070	1160	500
1.0	30	0.44	1.7	1.6	2.0	40.9	2620	2740	1.7	33.7	1280	1400	500
1.0	37	0.44	1.8	1.6	2.1	44.0	3030	3180	1.8	36.6	1560	1710	500
1.5	2	0.44	1.1	0.9	1.5	17.7	485	490	1.1	12.9	160	170	1000
1.5	4	0.44	1.2	0.9	1.5	20.1	650	660	1.2	15.3	265	285	1000
1.5	5	0.44	1.2	0.9	1.6	21.7	740	760	1.2	16.7	320	345	1000
1.5	6	0.44	1.3	1.25	1.6	24.2	980	1010	1.3	18.5	380	410	1000
1.5	8	0.44	1.3	1.25	1.7	26.7	1150	1190	1.3	20.8	485	520	1000
1.5	10	0.44	1.4	1.25	1.8	30.0	1380	1430	1.4	23.9	600	650	1000
1.5	12	0.44	1.5	1.25	1.8	31.0	1520	1570	1.5	24.9	710	770	1000
1.5	16	0.44	1.6	1.25	1.9	34.3	1830	1910	1.6	28.0	920	990	500/1000
1.5	18	0.44	1.6	1.6	1.9	36.5	2180	2270	1.6	29.5	1020	1100	500
1.5	19	0.44	1.6	1.6	1.9	36.5	2230	2310	1.6	29.5	1070	1150	500
1.5	20	0.44	1.7	1.6	2.0	38.6	2380	2480	1.7	31.4	1140	1230	500
1.5	24	0.44	1.8	1.6	2.1	42.5	2760	2880	1.8	35.1	1360	1470	500
1.5	30	0.44	1.9	1.6	2.1	44.9	3160	3300	1.9	37.5	1660	1800	500
1.5	37	0.44	2.0	2.0	2.2	49.2	3970	4140	2.0	40.8	2020	2190	500
2.5	2	0.53	1.2	0.9	1.5	20.0	600	610	1.2	15.2	220	235	1000
2.5	4	0.53	1.3	1.25	1.6	23.8	960	980	1.3	18.1	375	400	1000
2.5	5	0.53	1.3	1.25	1.7	25.8	1090	1120	1.3	19.9	450	485	1000
2.5	6	0.53	1.4	1.25	1.7	27.8	1250	1290	1.4	21.9	540	580	1000
2.5	8	0.53	1.5	1.25	1.8	31.1	1510	1560	1.5	25.0	700	750	1000
2.5	10	0.53	1.6	1.6	1.9	35.6	2000	2070	1.6	28.6	870	940	500/1000
2.5	12	0.53	1.6	1.6	1.9	36.7	2170	2250	1.6	29.7	1010	1090	500
2.5	16	0.53	1.8	1.6	2.0	40.7	2660	2770	1.8	33.5	1320	1430	500
2.5	18	0.53	1.8	1.6	2.1	42.8	2890	3010	1.8	35.4	1470	1590	500
2.5	19	0.53	1.8	1.6	2.1	42.8	2960	3090	1.8	35.4	1540	1660	500
2.5	20	0.53	1.9	1.6	2.1	45.0	3130	3270	1.9	37.6	1640	1770	500
2.5	24	0.53	2.0	2.0	2.3	50.7	4000	4160	2.0	42.1	1960	2120	500
2.5	30	0.53	2.1	2.0	2.3	53.4	4540	4740	2.1	44.8	2390	2590	500
2.5	37	0.53	2.3	2.0	2.4	57.8	5310	5560	2.3	49.0	2930	3180	500

For Cables of sizes or pairs not listed above the product data is available on request
Larger Drum Lengths are possible against specific requirements on request

• Dimensions & Weights are representative figures and may vary

Weight & Dimension Data

500 VOLTS, MULTI TRIAD, STR. COPPER, PVC/PE INSULATED ALUMINIUM MYLAR TAPED INDIVIDUAL AND OVERALL SHIELDED, ARMoured AND UNARMoured INSTRUMENTATION CABLES AS PER EN 50228

Area of conductor	No of triad	Minimum thickness of insulation	ARMoured CABLES						UNARMoured CABLES				Normal Drum Length with $\pm 5\%$
			Nominal thickness of inner sheath	Diameter of G.I. armour wire	Nominal thickness of outer sheath	Nominal overall diameter	Approx. weight - PE insulation	Approx. weight - PVC insulation	Nominal thickness of outer sheath	Nominal overall diameter	Approx. weight - PE insulation	Approx. weight - PVC insulation	
mm ²		mm	mm	mm	mm	mm	kg/km	kg/km	mm	mm	kg/km	kg/km	m
0.5	2	0.44	1.0	0.9	1.4	15.9	400	410	1.0	11.3	115	125	1000
0.5	4	0.44	1.1	0.9	1.5	18.2	530	550	1.1	13.4	195	210	1000
0.5	5	0.44	1.1	0.9	1.5	19.5	590	620	1.1	14.7	230	255	1000
0.5	6	0.44	1.2	0.9	1.6	21.2	690	720	1.2	16.2	275	305	1000
0.5	8	0.44	1.3	1.25	1.6	24.2	950	990	1.3	18.5	355	395	1000
0.5	10	0.44	1.3	1.25	1.7	26.9	1110	1160	1.3	21.0	430	480	1000
0.5	12	0.44	1.4	1.25	1.7	27.8	1210	1270	1.4	21.9	510	560	1000
0.5	14	0.44	1.4	1.25	1.7	28.9	1310	1380	1.4	23.0	570	640	1000
0.5	16	0.44	1.4	1.25	1.8	30.5	1440	1510	1.4	24.4	640	720	1000
0.5	19	0.44	1.5	1.25	1.8	32.0	1590	1680	1.5	25.9	750	840	500/1000
0.5	20	0.44	1.5	1.25	1.8	33.5	1680	1770	1.5	27.4	790	890	500/1000
0.5	24	0.44	1.6	1.6	1.9	37.6	2160	2270	1.6	30.6	950	1070	500
0.5	30	0.44	1.7	1.6	2.0	39.9	2450	2600	1.7	32.7	1160	1300	500
0.5	37	0.44	1.8	1.6	2.1	43.0	2830	3010	1.8	35.6	1410	1580	500
0.75	2	0.44	1.1	0.9	1.5	17.2	460	470	1.1	12.4	145	155	1000
0.75	4	0.44	1.1	0.9	1.5	19.2	590	620	1.1	14.4	230	255	1000
0.75	5	0.44	1.2	0.9	1.6	21.0	690	720	1.2	16.0	285	315	1000
0.75	6	0.44	1.2	1.25	1.6	23.2	900	930	1.2	17.5	335	365	1000
0.75	8	0.44	1.3	1.25	1.7	25.8	1080	1130	1.3	19.9	430	475	1000
0.75	10	0.44	1.4	1.25	1.7	28.8	1270	1330	1.4	22.9	540	590	1000
0.75	12	0.44	1.4	1.25	1.8	29.8	1390	1450	1.4	23.7	620	680	1000
0.75	14	0.44	1.5	1.25	1.8	31.2	1530	1600	1.5	25.1	720	790	500/1000
0.75	16	0.44	1.5	1.25	1.8	32.6	1660	1740	1.5	26.5	800	890	500/1000
0.75	19	0.44	1.6	1.25	1.9	34.5	1870	1970	1.6	28.2	940	1040	500/1000
0.75	20	0.44	1.6	1.6	1.9	36.9	2170	2280	1.6	29.9	990	1100	500
0.75	24	0.44	1.7	1.6	2.0	40.6	2500	2630	1.7	33.4	1190	1320	500
0.75	30	0.44	1.8	1.6	2.1	43.0	2880	3040	1.8	35.6	1450	1610	500
0.75	37	0.44	1.9	1.6	2.1	46.1	3300	3500	1.9	38.7	1760	1960	500
1.0	2	0.44	1.1	0.9	1.5	17.9	495	510	1.1	13.1	165	175	1000
1.0	4	0.44	1.1	0.9	1.5	20.1	650	670	1.1	15.3	270	295	1000
1.0	5	0.44	1.2	0.9	1.6	22.0	760	790	1.2	17.0	335	365	1000
1.0	6	0.44	1.2	1.25	1.6	24.3	990	1020	1.2	18.6	390	425	1000
1.0	8	0.44	1.3	1.25	1.7	27.1	1190	1240	1.3	21.2	510	560	1000
1.0	10	0.44	1.4	1.25	1.8	30.4	1420	1480	1.4	24.3	630	690	1000
1.0	12	0.44	1.5	1.25	1.8	31.5	1560	1640	1.5	25.4	740	810	500/1000
1.0	14	0.44	1.5	1.25	1.8	32.8	1710	1790	1.5	26.7	840	930	500/1000

Weight & Dimension Data

500 VOLTS, MULTI TRIAD, STR. COPPER, PVC/PE INSULATED ALUMINIUM MYLAR TAPED INDIVIDUAL AND OVERALL SHIELDED, ARMoured AND UNARMoured INSTRUMENTATION CABLES AS PER EN 50228

Area of conductor	No of triad	Minimum thickness of insulation	ARMoured CABLES						UNARMoured CABLES				Normal Drum Length with $\pm 5\%$
			Nominal thickness of inner sheath	Diameter of G.I. armour wire	Nominal thickness of outer sheath	Nominal overall diameter	Approx. weight - PE insulation	Approx. weight - PVC insulation	Nominal thickness of outer sheath	Nominal overall diameter	Approx. weight - PE insulation	Approx. weight - PVC insulation	
mm ²		mm	mm	mm	mm	mm	kg/km	kg/km	mm	mm	kg/km	kg/km	m
1.0	16	0.44	1.5	1.25	1.8	34.4	1860	1950	1.5	28.3	950	1050	500/1000
1.0	19	0.44	1.6	1.6	1.9	37.1	2300	2410	1.6	30.1	1110	1230	500
1.0	20	0.44	1.7	1.6	2.0	39.2	2460	2580	1.7	32.0	1190	1310	500
1.0	24	0.44	1.8	1.6	2.0	43.0	2830	2970	1.8	35.8	1420	1570	500
1.0	30	0.44	1.9	1.6	2.1	45.6	3260	3440	1.9	38.2	1740	1920	500
1.0	37	0.44	2.0	2.0	2.2	49.9	4100	4320	2.0	41.5	2110	2340	500
1.5	2	0.44	1.1	0.9	1.5	19.1	560	570	1.1	14.3	205	215	1000
1.5	4	0.44	1.2	1.25	1.6	22.7	890	920	1.2	17.0	350	375	1000
1.5	5	0.44	1.3	1.25	1.6	24.6	1030	1060	1.3	18.9	430	465	1000
1.5	6	0.44	1.3	1.25	1.7	26.5	1170	1210	1.3	20.6	500	550	1000
1.5	8	0.44	1.4	1.25	1.8	29.6	1420	1480	1.4	23.5	660	710	1000
1.5	10	0.44	1.5	1.25	1.8	33.1	1680	1750	1.5	27.0	820	890	500/1000
1.5	12	0.44	1.6	1.25	1.9	34.4	1880	1970	1.6	28.1	960	1040	500/1000
1.5	14	0.44	1.6	1.6	1.9	36.6	2260	2350	1.6	29.6	1100	1190	500
1.5	16	0.44	1.7	1.6	2.0	38.7	2500	2610	1.7	31.5	1250	1360	500
1.5	19	0.44	1.7	1.6	2.0	40.5	2760	2900	1.7	33.3	1450	1580	500
1.5	20	0.44	1.8	1.6	2.1	42.9	2970	3110	1.8	35.5	1540	1680	500
1.5	24	0.44	1.9	1.6	2.2	47.2	3450	3620	1.9	39.6	1850	2010	500
1.5	30	0.44	2.0	2.0	2.2	50.7	4280	4490	2.0	42.3	2260	2470	500
1.5	37	0.44	2.1	2.0	2.3	54.6	4960	5220	2.1	46.0	2750	3010	500
2.5	2	0.53	1.2	1.25	1.6	22.7	830	850	1.2	17.0	285	305	1000
2.5	4	0.53	1.3	1.25	1.7	26.1	1150	1190	1.3	20.2	500	540	1000
2.5	5	0.53	1.4	1.25	1.7	28.3	1340	1390	1.4	22.4	620	670	1000
2.5	6	0.53	1.5	1.25	1.8	30.8	1540	1600	1.5	24.7	740	800	1000
2.5	8	0.53	1.6	1.6	1.9	35.2	2070	2150	1.6	28.2	960	1040	500/1000
2.5	10	0.53	1.7	1.6	2.0	39.5	2480	2580	1.7	32.3	1190	1290	500
2.5	12	0.53	1.8	1.6	2.0	40.8	2740	2860	1.8	33.6	1400	1520	500
2.5	14	0.53	1.8	1.6	2.1	42.8	3030	3170	1.8	35.4	1600	1740	500
2.5	16	0.53	1.9	1.6	2.1	45.1	3320	3480	1.9	37.7	1820	1980	500
2.5	19	0.53	2.0	2.0	2.2	48.5	4050	4240	2.0	40.1	2140	2330	500
2.5	20	0.53	2.1	2.0	2.3	51.2	4350	4550	2.1	42.6	2280	2480	500
2.5	24	0.53	2.2	2.0	2.4	56.4	5030	5270	2.2	47.6	2720	2960	400
2.5	30	0.53	2.3	2.5	2.5	60.8	6300	6600	2.3	50.8	3330	3630	300
2.5	37	0.53	2.5	2.5	2.6	65.6	7340	7710	2.5	55.4	4080	4450	300

For Cables of sizes or triads not listed above the product data is available on request
Larger Drum Lengths are possible against specific requirements on request

• Dimensions & Weights are representative figures and may vary

Weight & Dimension Data

300/500 VOLTS, SINGLE AND MULTI PAIR, STR. COPPER, PVC/PE INSULATED ALUMINIUM MYLAR TAPED OVERALL SHIELDED, ARMoured AND UNARMoured INSTRUMENTATION CABLES GENERALLY AS PER IS

Area of conductor	No of pair	Minimum thickness of insulation	ARMoured CABLES						UNARMoured CABLES				Normal Drum Length with $\pm 5\%$
			Minimum thickness of inner sheath	Dimension of G.I. armour (wire/strip)	Minimum thickness of outer sheath	Nominal overall diameter	Approx. weight of cable - PE insulation	Approx. weight of cable - PVC insulation	Nominal thickness of outer sheath	Nominal overall diameter	Approx. weight of cable - PE insulation	Approx. weight of cable - PVC insulation	
mm ²		mm	mm	mm	mm	mm	kg/km	kg/km	mm	mm	kg/km	kg/km	m
0.5	1	0.44	0.3	0.9	1.24	10.1	185	190	1.8	8.2	76	79	1000
0.5	2	0.44	0.3	0.9	1.24	12.8	270	275	1.8	10.9	115	120	1000
0.5	4	0.44	0.3	0.9	1.24	14.2	330	345	1.8	12.3	155	170	1000
0.5	5	0.44	0.3	0.9	1.24	15.2	365	380	1.8	13.3	180	195	1000
0.5	6	0.44	0.3	0.9	1.24	16.2	405	425	1.8	14.3	205	220	1000
0.5	8	0.44	0.3	0.9	1.24	17.8	475	500	1.8	15.9	245	270	1000
0.5	10	0.44	0.3	0.9	1.24	19.7	550	580	1.8	17.8	290	320	1000
0.5	12	0.44	0.3	0.9	1.24	20.2	590	630	1.8	18.3	325	360	1000
0.5	16	0.44	0.3	4.0 x 0.8	1.40	22.2	730	780	1.8	20.2	395	445	1000
0.5	18	0.44	0.3	4.0 x 0.8	1.40	23.3	790	850	1.8	21.2	435	490	1000
0.5	19	0.44	0.3	4.0 x 0.8	1.40	23.3	810	870	1.8	21.2	445	510	1000
0.5	20	0.44	0.3	4.0 x 0.8	1.40	24.4	830	890	2.0	22.8	495	560	1000
0.5	24	0.44	0.3	4.0 x 0.8	1.40	26.7	960	1040	2.0	25.1	570	650	1000
0.5	30	0.44	0.3	4.0 x 0.8	1.40	28.1	1080	1180	2.0	26.5	670	760	1000
0.5	37	0.44	0.3	4.0 x 0.8	1.40	30.2	1220	1340	2.0	28.5	790	900	500/1000
0.75	1	0.44	0.3	0.9	1.24	10.5	200	205	1.8	8.6	86	89	1000
0.75	2	0.44	0.3	0.9	1.24	13.5	290	300	1.8	11.6	135	140	1000
0.75	4	0.44	0.3	0.9	1.24	15.1	375	385	1.8	13.2	185	200	1000
0.75	5	0.44	0.3	0.9	1.24	16.1	420	435	1.8	14.2	215	235	1000
0.75	6	0.44	0.3	0.9	1.24	17.3	465	485	1.8	15.4	245	265	1000
0.75	8	0.44	0.3	0.9	1.24	19.0	550	580	1.8	17.1	300	330	1000
0.75	10	0.44	0.3	4.0 x 0.8	1.40	21.2	660	700	1.8	19.2	355	395	1000
0.75	12	0.44	0.3	4.0 x 0.8	1.40	21.8	730	780	1.8	19.8	400	445	1000
0.75	16	0.44	0.3	4.0 x 0.8	1.40	23.9	860	910	2.0	22.2	520	580	1000
0.75	18	0.44	0.3	4.0 x 0.8	1.40	25.0	930	1000	2.0	23.4	570	630	1000
0.75	19	0.44	0.3	4.0 x 0.8	1.40	25.0	950	1020	2.0	23.4	590	660	1000
0.75	20	0.44	0.3	4.0 x 0.8	1.40	26.2	980	1060	2.0	24.6	620	690	1000
0.75	24	0.44	0.3	4.0 x 0.8	1.40	28.8	1140	1220	2.0	27.2	720	810	1000
0.75	30	0.44	0.3	4.0 x 0.8	1.40	30.3	1290	1400	2.0	28.7	850	960	500/1000
0.75	37	0.44	0.3	4.0 x 0.8	1.4	32.6	1500	1630	2.0	31.0	1010	1140	500/1000
1.0	1	0.44	0.3	0.9	1.24	10.9	215	220	1.8	9.0	95	99	1000
1.0	2	0.44	0.3	0.9	1.24	14.1	320	330	1.8	12.2	150	160	1000
1.0	4	0.44	0.3	0.9	1.24	15.8	415	430	1.8	13.9	215	230	1000
1.0	5	0.44	0.3	0.9	1.24	16.9	465	485	1.8	15.0	250	270	1000
1.0	6	0.44	0.3	0.9	1.24	18.1	520	550	1.8	16.3	290	310	1000
1.0	8	0.44	0.3	0.9	1.24	20.0	620	650	1.8	18.1	355	390	1000
1.0	10	0.44	0.3	4.0 x 0.8	1.40	22.4	760	800	1.8	20.3	425	465	1000
1.0	12	0.44	0.3	4.0 x 0.8	1.40	23.0	820	870	1.8	21.0	485	530	1000

Weight & Dimension Data

300/500 VOLTS, SINGLE AND MULTI PAIR, STR. COPPER, PVC/PE INSULATED ALUMINIUM MYLAR TAPED OVERALL SHIELDED, ARMoured AND UNARMoured INSTRUMENTATION CABLES GENERALLY AS PER IS

Area of conductor	No of pair	Minimum thickness of insulation	ARMoured CABLES						UNARMoured CABLES				Normal Drum Length with $\pm 5\%$
			Minimum thickness of inner sheath	Dimension of G.I. armour (wire/strip)	Minimum thickness of outer sheath	Nominal overall diameter	Approx. weight of cable - PE insulation	Approx. weight of cable - PVC insulation	Nominal thickness of outer sheath	Nominal overall diameter	Approx. weight of cable - PE insulation	Approx. weight of cable - PVC insulation	
mm ²		mm	mm	mm	mm	mm	kg/km	kg/km	mm	mm	kg/km	kg/km	m
1.0	16	0.44	0.3	4.0 x 0.8	1.40	25.2	990	1050	2.0	23.6	630	690	1000
1.0	18	0.44	0.3	4.0 x 0.8	1.40	26.5	1080	1150	2.0	24.9	690	760	1000
1.0	19	0.44	0.3	4.0 x 0.8	1.40	26.5	1100	1180	2.0	24.9	710	790	1000
1.0	20	0.44	0.3	4.0 x 0.8	1.40	27.8	1140	1220	2.0	26.2	750	830	1000
1.0	24	0.44	0.3	4.0 x 0.8	1.40	30.6	1320	1420	2.0	28.9	880	980	500/1000
1.0	30	0.44	0.3	4.0 x 0.8	1.40	32.2	1510	1630	2.0	30.6	1050	1170	500/1000
1.0	37	0.44	0.3	4.0 x 0.8	1.56	34.9	1790	1940	2.0	33.0	1250	1400	500/1000
1.5	1	0.44	0.3	0.9	1.24	11.5	240	245	1.8	9.6	110	115	1000
1.5	2	0.44	0.3	0.9	1.24	15.0	365	375	1.8	13.2	180	185	1000
1.5	4	0.44	0.3	0.9	1.24	17.0	485	500	1.8	15.1	265	285	1000
1.5	5	0.44	0.3	0.9	1.24	18.2	550	570	1.8	16.4	310	335	1000
1.5	6	0.44	0.3	0.9	1.24	19.6	620	640	1.8	17.7	360	385	1000
1.5	8	0.44	0.3	4.0 x 0.8	1.40	21.8	780	820	1.8	19.8	450	485	1000
1.5	10	0.44	0.3	4.0 x 0.8	1.40	24.4	900	950	2.0	22.7	560	610	1000
1.5	16	0.44	0.3	4.0 x 0.8	1.40	27.6	1190	1260	2.0	25.9	800	880	1000
1.5	18	0.44	0.3	4.0 x 0.8	1.40	28.9	1300	1380	2.0	27.3	890	970	1000
1.5	19	0.44	0.3	4.0 x 0.8	1.40	28.9	1330	1420	2.0	27.3	920	1010	1000
1.5	20	0.44	0.3	4.0 x 0.8	1.40	30.4	1410	1500	2.0	28.8	970	1060	500/1000
1.5	24	0.44	0.3	4.0 x 0.8	1.56	33.8	1650	1760	2.0	31.9	1140	1250	500/1000
1.5	30	0.44	0.3	4.0 x 0.8	1.56	35.7	1900	2040	2.0	33.8	1370	1500	500
1.5	37	0.44	0.4	4.0 x 0.8	1.56	38.6	2240	2410	2.2	36.9	1670	1840	500
2.5	1	0.53	0.3	0.9	1.24	12.7	290	295	1.8	10.8	140	150	1000
2.5	2	0.53	0.3	0.9	1.24	17.0	455	470	1.8	15.2	235	250	1000
2.5	4	0.53	0.3	0.9	1.24	19.4	620	650	1.8	17.5	365	395	1000
2.5	5	0.53	0.3	4.0 x 0.8	1.40	21.1	740	780	1.8	19.1	435	470	1000
2.5	6	0.53	0.3	4.0 x 0.8	1.40	22.8	840	880	1.8	20.7	510	550	1000
2.5	8	0.53	0.3	4.0 x 0.8	1.40	25.3	1020	1080	2.0	23.7	660	710	1000
2.5	10	0.53	0.3	4.0 x 0.8	1.40	28.4	1210	1280	2.0	26.7	800	870	1000
2.5	12	0.53	0.3	4.0 x 0.8	1.40	29.3	1330	1410	2.0	27.6	920	1000	1000
2.5	16	0.53	0.3	4.0 x 0.8	1.56	32.6	1650	1760	2.0	30.6	1170	1270	500/1000
2.5	18	0.53	0.3	4.0 x 0.8	1.56	34.2	1800	1920	2.0	32.3	1290	1410	500/1000
2.5	19	0.53	0.3	4.0 x 0.8	1.56	34.2	1860	1990	2.0	32.3	1350	1470	500/1000
2.5	20	0.53	0.4	4.0 x 0.8	1.56	36.3	2000	2130	2.2	34.6	1450	1590	500
2.5	24	0.53	0.4	4.0 x 0.8	1.56	40.0	2310	2470	2.2	38.3	1710	1870	500
2.5	30	0.53	0.4	4.0 x 0.8	1.56	42.3	2710	2910	2.2	40.6	2060	2260	500
2.5	37	0.53	0.4	4.0 x 0.8	1.72	45.9	3220	3460	2.2	43.9	2480	2730	500

For Cables of sizes or pairs not listed above the product data is available on request
Larger Drum Lengths are possible against specific requirements on request

• Dimensions & Weights are representative figures and may vary

Weight & Dimension Data

300/500 VOLTS, SINGLE AND MULTI TRIAD, STR. COPPER, PVC/PE INSULATED ALUMINIUM MYLAR TAPED OVERALL SHIELDED, ARMoured AND UNARMoured INSTRUMENTATION CABLES GENERALLY AS PER IS

Area of conductor	No of triad	Minimum thickness of insulation	ARMoured CABLES						UNARMoured CABLES				Normal Drum Length with $\pm 5\%$
			Minimum thickness of inner sheath	Dimension of G.I. armour (wire/strip)	Minimum thickness of outer sheath	Nominal overall diameter	Approx. weight of cable - PE insulation	Approx. weight of cable - PVC insulation	Nominal thickness of outer sheath	Nominal overall diameter	Approx. weight of cable - PE insulation	Approx. weight of cable - PVC insulation	
mm ²		mm	mm	mm	mm	mm	kg/km	kg/km	mm	mm	kg/km	kg/km	m
0.5	1	0.44	0.3	0.9	1.24	10.4	200	205	1.8	8.6	86	91	1000
0.5	2	0.44	0.3	0.9	1.24	13.7	305	315	1.8	11.9	140	150	1000
0.5	4	0.44	0.3	0.9	1.24	15.4	385	405	1.8	13.5	195	215	1000
0.5	5	0.44	0.3	0.9	1.24	16.5	435	460	1.8	14.6	225	250	1000
0.5	6	0.44	0.3	0.9	1.24	17.7	490	520	1.8	15.8	260	285	1000
0.5	8	0.44	0.3	0.9	1.24	19.4	570	610	1.8	17.6	315	355	1000
0.5	10	0.44	0.3	4.0 x 0.8	1.40	21.8	710	760	1.8	19.7	375	425	1000
0.5	12	0.44	0.3	4.0 x 0.8	1.40	22.4	760	810	1.8	20.4	425	480	1000
0.5	14	0.44	0.3	4.0 x 0.8	1.40	23.4	830	900	1.8	21.3	475	540	1000
0.5	16	0.44	0.3	4.0 x 0.8	1.40	24.5	890	960	2.0	22.9	550	630	1000
0.5	19	0.44	0.3	4.0 x 0.8	1.40	25.7	990	1080	2.0	24.1	620	710	1000
0.5	20	0.44	0.3	4.0 x 0.8	1.40	27.0	1050	1140	2.0	25.4	660	750	1000
0.5	24	0.44	0.3	4.0 x 0.8	1.40	29.6	1210	1320	2.0	28.0	770	880	1000
0.5	30	0.44	0.3	4.0 x 0.8	1.40	31.2	1370	1510	2.0	29.6	910	1050	500/1000
0.5	37	0.44	0.3	4.0 x 0.8	1.56	33.8	1590	1760	2.0	31.9	1080	1250	500/1000
0.75	1	0.44	0.3	0.9	1.24	10.9	220	225	1.8	9.0	99	105	1000
0.75	2	0.44	0.3	0.9	1.24	14.5	345	355	1.8	12.6	160	175	1000
0.75	4	0.44	0.3	0.9	1.24	16.3	445	465	1.8	14.5	235	260	1000
0.75	5	0.44	0.3	0.9	1.24	17.5	500	530	1.8	15.7	275	305	1000
0.75	6	0.44	0.3	0.9	1.24	18.8	560	600	1.8	17.0	315	350	1000
0.75	8	0.44	0.3	4.0 x 0.8	1.24	20.6	680	730	1.8	18.9	395	435	1000
0.75	10	0.44	0.3	4.0 x 0.8	1.40	23.3	830	890	1.8	21.3	475	530	1000
0.75	12	0.44	0.3	4.0 x 0.8	1.40	24.0	900	960	2.0	22.4	560	620	1000
0.75	14	0.44	0.3	4.0 x 0.8	1.40	25.1	990	1070	2.0	23.5	630	700	1000
0.75	16	0.44	0.3	4.0 x 0.8	1.40	26.3	1090	1170	2.0	24.7	700	780	1000
0.75	19	0.44	0.3	4.0 x 0.8	1.40	27.6	1190	1290	2.0	26.0	800	900	1000
0.75	20	0.44	0.3	4.0 x 0.8	1.40	29.1	1250	1360	2.0	27.4	840	950	1000
0.75	24	0.44	0.3	4.0 x 0.8	1.40	32.0	1450	1580	2.0	30.3	990	1120	500/1000
0.75	30	0.44	0.3	4.0 x 0.8	1.56	34.0	1690	1850	2.0	32.1	1180	1340	500/1000
0.75	37	0.44	0.4	4.0 x 0.8	1.56	36.8	1980	2180	2.2	35.1	1440	1640	500
1.0	1	0.44	0.3	0.9	1.24	11.3	240	245	1.8	9.4	110	115	1000
1.0	2	0.44	0.3	0.9	1.24	15.2	380	390	1.8	13.3	185	200	1000
1.0	4	0.44	0.3	0.9	1.24	17.2	500	520	1.8	15.3	280	305	1000
1.0	5	0.44	0.3	0.9	1.24	18.5	570	600	1.8	16.6	330	360	1000
1.0	6	0.44	0.3	0.9	1.24	19.9	640	680	1.8	18.0	380	415	1000
1.0	8	0.44	0.3	4.0 x 0.8	1.40	22.1	810	860	1.8	20.1	475	520	1000
1.0	10	0.44	0.3	4.0 x 0.8	1.40	24.7	930	990	2.0	23.0	600	660	1000
1.0	12	0.44	0.3	4.0 x 0.8	1.40	25.4	1040	1110	2.0	23.8	680	750	1000
1.0	14	0.44	0.3	4.0 x 0.8	1.40	26.6	1150	1240	2.0	25.0	770	850	1000

Weight & Dimension Data

300/500 VOLTS, SINGLE AND MULTI TRIAD, STR. COPPER, PVC/PE INSULATED ALUMINIUM MYLAR TAPED OVERALL SHIELDED, ARMoured AND UNARMoured INSTRUMENTATION CABLES GENERALLY AS PER IS

Area of conductor	No of triad	Minimum thickness of insulation	ARMoured CABLES						UNARMoured CABLES				Normal Drum Length with $\pm 5\%$
			Minimum thickness of inner sheath	Dimension of G.I. armour (wire/strip)	Minimum thickness of outer sheath	Nominal overall diameter	Approx. weight of cable - PE insulation	Approx. weight of cable - PVC insulation	Nominal thickness of outer sheath	Nominal overall diameter	Approx. weight of cable - PE insulation	Approx. weight of cable - PVC insulation	
mm ²		mm	mm	mm	mm	mm	kg/km	kg/km	mm	mm	kg/km	kg/km	m
1.0	16	0.44	0.3	4.0 x 0.8	1.40	27.9	1270	1360	2.0	26.3	850	950	1000
1.0	19	0.44	0.3	4.0 x 0.8	1.40	29.3	1390	1510	2.0	27.7	980	1100	1000
1.0	20	0.44	0.3	4.0 x 0.8	1.40	30.9	1470	1590	2.0	29.2	1030	1150	500/1000
1.0	24	0.44	0.3	4.0 x 0.8	1.40	34.0	1710	1850	2.0	32.4	1220	1360	500/1000
1.0	30	0.44	0.3	4.0 x 0.8	1.56	36.2	2030	2210	2.0	34.3	1460	1640	500
1.0	37	0.44	0.4	4.0 x 0.8	1.56	39.1	2390	2610	2.2	37.4	1790	2010	500
1.5	1	0.44	0.3	0.9	1.24	11.9	270	275	1.8	10.0	130	140	1000
1.5	2	0.44	0.3	0.9	1.24	16.3	435	445	1.8	14.4	225	240	1000
1.5	4	0.44	0.3	0.9	1.24	18.5	590	620	1.8	16.6	350	375	1000
1.5	5	0.44	0.3	0.9	1.24	20.0	680	710	1.8	18.1	415	450	1000
1.5	6	0.44	0.3	4.0 x 0.8	1.40	21.7	790	830	1.8	19.7	480	520	1000
1.5	8	0.44	0.3	4.0 x 0.8	1.40	24.1	970	1020	2.0	22.4	630	680	1000
1.5	10	0.44	0.3	4.0 x 0.8	1.40	26.9	1150	1220	2.0	25.3	760	830	1000
1.5	12	0.44	0.3	4.0 x 0.8	1.40	27.8	1260	1340	2.0	26.1	870	960	1000
1.5	14	0.44	0.3	4.0 x 0.8	1.40	29.1	1400	1500	2.0	27.4	990	1090	1000
1.5	16	0.44	0.3	4.0 x 0.8	1.40	30.6	1550	1660	2.0	28.9	1110	1220	500/1000
1.5	19	0.44	0.3	4.0 x 0.8	1.40	32.1	1740	1880	2.0	30.5	1280	1410	500/1000
1.5	20	0.44	0.3	4.0 x 0.8	1.56	34.2	1860	2000	2.0	32.2	1350	1490	500/1000
1.5	24	0.44	0.4	4.0 x 0.8	1.56	37.9	2200	2370	2.2	36.2	1630	1800	500
1.5	30	0.44	0.4	4.0 x 0.8	1.56	40.0	2560	2770	2.2	38.3	1960	2170	500
1.5	37	0.44	0.4	4.0 x 0.8	1.56	43.1	3010	3260	2.2	41.4	2360	2620	500
2.5	1	0.53	0.3	0.9	1.24	13.2	335	345	1.8	11.4	175	185	1000
2.5	2	0.53	0.3	0.9	1.24	18.6	550	570	1.8	16.7	305	325	1000
2.5	4	0.53	0.3	4.0 x 0.8	1.40	21.4	800	840	1.8	19.4	495	530	1000
2.5	5	0.53	0.3	0.4 x 0.8	1.40	23.2	920	970	2.0	21.6	610	660	1000
2.5	6	0.53	0.3	0.4 x 0.8	1.40	25.1	1080	1140	2.0	23.5	710	770	1000
2.5	8	0.53	0.3	0.4 x 0.8	1.40	28.0	1320	1400	2.0	26.3	910	980	1000
2.5	10	0.53	0.3	0.4 x 0.8	1.40	31.5	1570	1670	2.0	29.8	1100	1200	500/1000
2.5	12	0.53	0.3	0.4 x 0.8	1.56	32.8	1760	1880	2.0	30.8	1280	1400	500/1000
2.5	14	0.53	0.3	0.4 x 0.8	1.56	34.4	1990	2130	2.0	32.4	1460	1600	500/1000
2.5	16	0.53	0.4	0.4 x 0.8	1.56	36.4	2220	2380	2.2	34.7	1670	1830	500
2.5	19	0.53	0.4	0.4 x 0.8	1.56	38.3	2510	2700	2.2	36.6	1940	2130	500
2.5	20	0.53	0.4	0.4 x 0.8	1.56	40.4	2640	2840	2.2	38.7	2040	2240	500
2.5	24	0.53	0.4	0.4 x 0.8	1.72	45.0	3130	3370	2.2	42.9	2420	2650	500
2.5	30	0.53	0.5	0.4 x 0.8	1.72	47.8	3720	4020	2.4	46.0	2980	3280	500
2.5	37	0.53	0.5	0.4 x 0.8	1.88	51.9	4430	4800	2.4	49.7	3590	3960	500

For Cables of sizes or triads not listed above the product data is available on request
Larger Drum Lengths are possible against specific requirements on request

Weight & Dimension Data

300/500 VOLTS, MULTI PAIR, STR. COPPER, PVC/PE INSULATED ALUMINIUM MYLAR TAPED INDIVIDUAL AND OVERALL SHIELDED, ARMoured AND UNARMoured INSTRUMENTATION CABLES GENERALLY AS PER IS

Area of conductor	No of pair	Minimum thickness of insulation	ARMoured CABLES						UNARMoured CABLES				Normal Drum Length with $\pm 5\%$
			Minimum thickness of inner sheath	Dimension of G.I. armour (wire/strip)	Minimum thickness of outer sheath	Nominal overall diameter	Approx. weight of cable - PE insulation	Approx. weight of cable - PVC insulation	Nominal thickness of outer sheath	Nominal overall diameter	Approx. weight of cable - PE insulation	Approx. weight of cable - PVC insulation	
mm ²		mm	mm	mm	mm	mm	kg/km	kg/km	mm	mm	kg/km	kg/km	m
0.5	2	0.44	0.3	0.9	1.24	13.9	310	320	1.8	12.0	140	150	1000
0.5	4	0.44	0.3	0.9	1.24	15.6	400	410	1.8	13.7	200	215	1000
0.5	5	0.44	0.3	0.9	1.24	16.7	445	460	1.8	14.8	230	250	1000
0.5	6	0.44	0.3	0.9	1.24	17.9	495	510	1.8	16.0	265	285	1000
0.5	8	0.44	0.3	0.9	1.24	19.7	580	610	1.8	17.8	325	350	1000
0.5	10	0.44	0.3	4.0 x 0.8	1.40	22.0	720	750	1.8	20.0	390	420	1000
0.5	12	0.44	0.3	4.0 x 0.8	1.40	22.7	770	810	1.8	20.6	435	475	1000
0.5	16	0.44	0.3	4.0 x 0.8	1.40	24.8	930	980	2.0	23.2	570	620	1000
0.5	18	0.44	0.3	4.0 x 0.8	1.40	26.0	990	1040	2.0	24.4	620	680	1000
0.5	19	0.44	0.3	4.0 x 0.8	1.40	26.0	1010	1070	2.0	24.4	640	700	1000
0.5	20	0.44	0.3	4.0 x 0.8	1.40	27.3	1070	1130	2.0	25.7	680	740	1000
0.5	24	0.44	0.3	4.0 x 0.8	1.40	30.3	1230	1310	2.0	28.4	790	870	500/1000
0.5	30	0.44	0.3	4.0 x 0.8	1.40	31.6	1400	1500	2.0	30.0	940	1030	500/1000
0.5	37	0.44	0.3	4.0 x 0.8	1.56	34.3	1630	1740	2.0	32.4	1110	1230	500/1000
0.75	2	0.44	0.3	0.9	1.24	14.6	340	350	1.8	12.7	160	165	1000
0.75	4	0.44	0.3	0.9	1.24	16.5	440	455	1.8	14.6	230	245	1000
0.75	5	0.44	0.3	0.9	1.24	17.7	500	520	1.8	15.8	270	290	1000
0.75	6	0.44	0.3	0.9	1.24	19.0	560	580	1.8	17.1	310	330	1000
0.75	8	0.44	0.3	4.0 x 0.8	1.40	21.1	690	720	1.8	19.1	385	410	1000
0.75	10	0.44	0.3	4.0 x 0.8	1.40	23.5	820	860	2.0	21.9	480	520	1000
0.75	12	0.44	0.3	4.0 x 0.8	1.40	24.2	880	920	2.0	22.6	540	590	1000
0.75	16	0.44	0.3	4.0 x 0.8	1.40	26.6	1060	1120	2.0	25.0	680	730	1000
0.75	18	0.44	0.3	4.0 x 0.8	1.40	27.9	1130	1200	2.0	26.3	740	810	1000
0.75	19	0.44	0.3	4.0 x 0.8	1.40	27.9	1160	1230	2.0	26.3	770	840	1000
0.75	20	0.44	0.3	4.0 x 0.8	1.40	29.3	1230	1300	2.0	27.7	810	890	1000
0.75	24	0.44	0.3	4.0 x 0.8	1.56	32.5	1440	1530	2.0	30.6	950	1040	500/1000
0.75	30	0.44	0.3	4.0 x 0.8	1.56	34.3	1670	1780	2.0	32.4	1130	1240	500/1000
0.75	37	0.44	0.4	4.0 x 0.8	1.56	37.1	1930	2070	2.2	35.4	1390	1520	500
1.0	2	0.44	0.3	0.9	1.24	15.3	370	380	1.8	13.4	180	185	1000
1.0	4	0.44	0.3	0.9	1.24	17.2	485	500	1.8	15.4	265	280	1000
1.0	5	0.44	0.3	0.9	1.24	18.5	550	570	1.8	16.7	310	330	1000
1.0	6	0.44	0.3	0.9	1.24	20.0	620	640	1.8	18.1	355	380	1000
1.0	8	0.44	0.3	4.0 x 0.8	1.40	22.2	780	810	1.8	20.2	440	475	1000
1.0	10	0.44	0.3	4.0 x 0.8	1.40	24.8	890	930	2.0	23.2	560	600	1000
1.0	12	0.44	0.3	4.0 x 0.8	1.40	25.5	990	1040	2.0	23.9	630	680	1000
1.0	16	0.44	0.3	4.0 x 0.8	1.40	28.1	1200	1270	2.0	26.5	790	850	1000

Weight & Dimension Data

300/500 VOLTS, MULTI PAIR, STR. COPPER, PVC/PE INSULATED ALUMINIUM MYLAR TAPED INDIVIDUAL AND OVERALL SHIELDED, ARMoured AND UNARMoured INSTRUMENTATION CABLES GENERALLY AS PER IS

Area of conductor	No of pair	Minimum thickness of insulation	ARMoured CABLES						UNARMoured CABLES				Normal Drum Length with ± 5%
			Minimum thickness of inner sheath	Dimension of G.I. armour (wire/strip)	Minimum thickness of outer sheath	Nominal overall diameter	Approx. weight of cable - PE insulation	Approx. weight of cable - PVC insulation	Nominal thickness of outer sheath	Nominal overall diameter	Approx. weight of cable - PE insulation	Approx. weight of cable - PVC insulation	
mm ²		mm	mm	mm	mm	mm	kg/km	kg/km	mm	mm	kg/km	kg/km	m
1.0	18	0.44	0.3	4.0 x 0.8	1.40	29.5	1310	1380	2.0	27.9	870	940	1000
1.0	19	0.44	0.3	4.0 x 0.8	1.40	29.5	1340	1420	2.0	27.9	900	980	1000
1.0	20	0.44	0.3	4.0 x 0.8	1.40	31.0	1420	1500	2.0	29.4	950	1030	500/1000
1.0	24	0.44	0.3	4.0 x 0.8	1.56	34.5	1660	1750	2.0	32.5	1120	1220	500/1000
1.0	30	0.44	0.4	4.0 x 0.8	1.56	36.6	1920	2040	2.2	34.9	1370	1490	500
1.0	37	0.44	0.4	4.0 x 0.8	1.56	39.4	2240	2380	2.2	37.7	1640	1790	500
1.5	2	0.44	0.3	0.9	1.24	16.3	415	425	1.8	14.5	210	215	1000
1.5	4	0.44	0.3	0.9	1.24	18.5	560	580	1.8	16.6	315	335	1000
1.5	5	0.44	0.3	4.0 x 0.8	1.24	19.8	640	660	1.8	18.1	370	395	1000
1.5	6	0.44	0.3	4.0 x 0.8	1.40	21.7	740	770	1.8	19.7	430	460	1000
1.5	8	0.44	0.3	4.0 x 0.8	1.40	24.1	900	940	2.0	22.4	560	600	1000
1.5	10	0.44	0.3	4.0 x 0.8	1.40	26.9	1070	1110	2.0	25.3	680	720	1000
1.5	12	0.44	0.3	4.0 x 0.8	1.40	27.8	1160	1220	2.0	26.1	770	830	1000
1.5	16	0.44	0.3	4.0 x 0.8	1.40	30.6	1410	1490	2.0	29.0	980	1050	500/1000
1.5	18	0.44	0.3	4.0 x 0.8	1.40	32.1	1540	1620	2.0	30.5	1080	1160	500/1000
1.5	19	0.44	0.3	4.0 x 0.8	1.40	32.1	1580	1670	2.0	30.5	1120	1210	500/1000
1.5	20	0.44	0.3	4.0 x 0.8	1.56	34.2	1700	1790	2.0	32.2	1180	1280	500/1000
1.5	24	0.44	0.4	4.0 x 0.8	1.56	37.9	2000	2110	2.2	36.2	1430	1540	500
1.5	30	0.44	0.4	4.0 x 0.8	1.56	40.0	2310	2450	2.2	38.3	1710	1850	500
1.5	37	0.44	0.4	4.0 x 0.8	1.56	43.1	2700	2870	2.2	41.4	2050	2220	500
2.5	2	0.53	0.3	0.9	1.24	18.5	510	520	1.8	16.6	270	285	1000
2.5	4	0.53	0.3	4.0 x 0.8	1.40	21.3	730	760	1.8	19.3	425	450	1000
2.5	5	0.53	0.3	0.4 x 0.8	1.40	23.1	840	870	2.0	21.5	520	560	1000
2.5	6	0.53	0.3	0.4 x 0.8	1.40	25.0	970	1010	2.0	23.3	610	650	1000
2.5	8	0.53	0.3	0.4 x 0.8	1.40	27.8	1150	1210	2.0	26.2	770	820	1000
2.5	10	0.53	0.3	0.4 x 0.8	1.40	31.3	1390	1460	2.0	29.6	930	1000	500/1000
2.5	12	0.53	0.3	0.4 x 0.8	1.56	32.6	1550	1630	2.0	30.7	1070	1150	500/1000
2.5	16	0.53	0.4	0.4 x 0.8	1.56	36.2	1940	2050	2.2	34.5	1390	1500	500
2.5	18	0.53	0.4	0.4 x 0.8	1.56	38.1	2110	2230	2.2	36.4	1540	1660	500
2.5	19	0.53	0.4	0.4 x 0.8	1.56	38.1	2180	2300	2.2	36.4	1610	1730	500
2.5	20	0.53	0.4	0.4 x 0.8	1.56	40.2	2290	2420	2.2	38.5	1690	1830	500
2.5	24	0.53	0.4	0.4 x 0.8	1.72	44.7	2710	2870	2.2	42.7	2000	2160	500
2.5	30	0.53	0.5	0.4 x 0.8	1.72	47.5	3200	3400	2.4	45.7	2460	2660	500
2.5	37	0.53	0.5	0.4 x 0.8	1.88	51.6	3780	4030	2.4	49.4	2950	3200	500

For Cables of sizes or pairs not listed above the product data is available on request
Larger Drum Lengths are possible against specific requirements on request

• Dimensions & Weights are representative figures and may vary

Weight & Dimension Data

300/500 VOLTS, MULTI TRIAD, STR. COPPER, PVC/PE INSULATED ALUMINIUM MYLAR TAPED INDIVIDUAL AND OVERALL SHIELDED, ARMoured AND UNARMoured INSTRUMENTATION CABLES GENERALLY AS PER IS

Area of conductor	No of triad	Minimum thickness of insulation	ARMoured CABLES						UNARMoured CABLES				Normal Drum Length with $\pm 5\%$
			Minimum thickness of inner sheath	Dimension of G.I. armour (wire/strip)	Minimum thickness of outer sheath	Nominal overall diameter	Approx. weight of cable - PE insulation	Approx. weight of cable - PVC insulation	Nominal thickness of outer sheath	Nominal overall diameter	Approx. weight of cable - PE insulation	Approx. weight of cable - PVC insulation	
mm ²		mm	mm	mm	mm	mm	kg/km	kg/km	mm	mm	kg/km	kg/km	m
0.5	2	0.44	0.3	0.9	1.24	15.0	355	360	1.8	13.1	165	175	1000
0.5	4	0.44	0.3	0.9	1.24	16.9	455	475	1.8	15.0	240	260	1000
0.5	5	0.44	0.3	0.9	1.24	18.1	520	540	1.8	16.3	280	305	1000
0.5	6	0.44	0.3	0.9	1.24	19.5	580	610	1.8	17.6	325	350	1000
0.5	8	0.44	0.3	4.0 x 0.8	1.40	21.7	710	750	1.8	19.7	400	440	1000
0.5	10	0.44	0.3	4.0 x 0.8	1.40	24.2	840	890	2.0	22.6	500	550	1000
0.5	12	0.44	0.3	4.0 x 0.8	1.40	24.9	930	990	2.0	23.3	570	620	1000
0.5	14	0.44	0.3	4.0 x 0.8	1.40	26.1	1000	1070	2.0	24.4	640	700	1000
0.5	16	0.44	0.3	4.0 x 0.8	1.40	27.4	1100	1170	2.0	25.8	710	780	1000
0.5	19	0.44	0.3	4.0 x 0.8	1.40	28.7	1220	1310	2.0	27.1	810	900	1000
0.5	20	0.44	0.3	4.0 x 0.8	1.40	30.2	1290	1380	2.0	28.6	850	950	500/1000
0.5	24	0.44	0.3	4.0 x 0.8	1.56	33.6	1510	1620	2.0	31.6	1000	1110	500/1000
0.5	30	0.44	0.4	4.0 x 0.8	1.56	35.6	1740	1890	2.2	33.9	1220	1360	500/1000
0.5	37	0.44	0.4	4.0 x 0.8	1.56	38.3	2020	2200	2.2	36.6	1450	1630	500
0.75	2	0.44	0.3	0.9	1.24	15.8	390	400	1.8	13.9	190	200	1000
0.75	4	0.44	0.3	0.9	1.24	17.9	510	540	1.8	16.0	285	305	1000
0.75	5	0.44	0.3	0.9	1.24	19.3	590	610	1.8	17.4	335	360	1000
0.75	6	0.44	0.3	4.0 x 0.8	1.40	20.9	690	730	1.8	18.9	385	420	1000
0.75	8	0.44	0.3	4.0 x 0.8	1.40	23.2	810	860	2.0	21.5	500	550	1000
0.75	10	0.44	0.3	4.0 x 0.8	1.40	25.9	970	1020	2.0	24.3	600	660	1000
0.75	12	0.44	0.3	4.0 x 0.8	1.40	26.7	1070	1140	2.0	25.1	690	750	1000
0.75	14	0.44	0.3	4.0 x 0.8	1.40	27.9	1190	1260	2.0	26.3	770	850	1000
0.75	16	0.44	0.3	4.0 x 0.8	1.40	29.4	1280	1360	2.0	27.7	860	950	1000
0.75	19	0.44	0.3	4.0 x 0.8	1.40	30.8	1430	1530	2.0	29.2	990	1090	500/1000
0.75	20	0.44	0.3	4.0 x 0.8	1.56	32.8	1530	1640	2.0	30.9	1040	1150	500/1000
0.75	24	0.44	0.4	4.0 x 0.8	1.56	36.3	1810	1940	2.2	34.6	1260	1390	500
0.75	30	0.44	0.4	4.0 x 0.8	1.56	38.3	2080	2240	2.2	36.6	1510	1670	500
0.75	37	0.44	0.4	4.0 x 0.8	1.56	41.3	2420	2620	2.2	39.6	1800	2000	500
1.0	2	0.44	0.3	0.9	1.24	16.5	425	435	1.8	14.7	215	230	1000
1.0	4	0.44	0.3	0.9	1.24	18.8	580	600	1.8	16.9	330	355	1000
1.0	5	0.44	0.3	0.9	1.24	20.3	660	690	1.8	18.4	390	420	1000
1.0	6	0.44	0.3	4.0 x 0.8	1.40	22.0	780	820	1.8	20.0	450	485	1000
1.0	8	0.44	0.3	4.0 x 0.8	1.40	24.4	930	970	2.0	22.8	590	640	1000
1.0	10	0.44	0.3	4.0 x 0.8	1.40	27.4	1100	1160	2.0	25.7	710	770	1000
1.0	12	0.44	0.3	4.0 x 0.8	1.40	28.2	1230	1300	2.0	26.6	810	880	1000
1.0	14	0.44	0.3	4.0 x 0.8	1.40	29.5	1360	1440	2.0	27.9	920	1000	1000

Weight & Dimension Data

300/500 VOLTS, MULTI TRIAD, STR. COPPER, PVC/PE INSULATED ALUMINIUM MYLAR TAPED INDIVIDUAL AND OVERALL SHIELDED, ARMoured AND UNARMoured INSTRUMENTATION CABLES GENERALLY AS PER IS

Area of conductor	No of triad	Minimum thickness of insulation	ARMoured CABLES						UNARMoured CABLES				Normal Drum Length with $\pm 5\%$
			Minimum thickness of inner sheath	Dimension of G.I. armour (wire/strip)	Minimum thickness of outer sheath	Nominal overall diameter	Approx. weight of cable - PE insulation	Approx. weight of cable - PVC insulation	Nominal thickness of outer sheath	Nominal overall diameter	Approx. weight of cable - PE insulation	Approx. weight of cable - PVC insulation	
mm ²		mm	mm	mm	mm	mm	kg/km	kg/km	mm	mm	kg/km	kg/km	m
1.0	16	0.44	0.3	4.0 x 0.8	1.40	31.1	1490	1590	2.0	29.5	1030	1120	500/1000
1.0	19	0.44	0.3	4.0 x 0.8	1.40	32.7	1670	1780	2.0	31.1	1180	1290	500/1000
1.0	20	0.44	0.3	4.0 x 0.8	1.56	34.7	1780	1900	2.0	32.8	1250	1370	500/1000
1.0	24	0.44	0.4	4.0 x 0.8	1.56	38.5	2080	2220	2.2	36.8	1500	1650	500
1.0	30	0.44	0.4	4.0 x 0.8	1.56	40.7	2430	2610	2.2	39.0	1800	1980	500
1.0	37	0.44	0.4	4.0 x 0.8	1.56	43.8	2840	3060	2.2	42.1	2160	2390	500
1.5	2	0.44	0.3	0.9	1.24	17.8	485	500	1.8	15.9	255	270	1000
1.5	4	0.44	0.3	4.0 x 0.8	1.24	20.1	690	720	1.8	18.4	400	430	1000
1.5	5	0.44	0.3	4.0 x 0.8	1.40	22.1	810	850	1.8	20.0	480	510	1000
1.5	6	0.44	0.3	4.0 x 0.8	1.40	23.9	920	960	2.0	22.2	580	620	1000
1.5	8	0.44	0.3	4.0 x 0.8	1.40	26.5	1120	1170	2.0	24.9	730	780	1000
1.5	10	0.44	0.3	4.0 x 0.8	1.40	29.8	1320	1390	2.0	28.2	880	950	500/1000
1.5	12	0.44	0.3	4.0 x 0.8	1.40	30.7	1450	1540	2.0	29.1	1010	1100	500/1000
1.5	14	0.44	0.3	4.0 x 0.8	1.56	32.5	1640	1740	2.0	30.6	1150	1250	500/1000
1.5	16	0.44	0.3	4.0 x 0.8	1.56	34.2	1800	1920	2.0	32.3	1290	1400	500/1000
1.5	19	0.44	0.4	4.0 x 0.8	1.56	36.2	2070	2200	2.2	34.5	1530	1660	500
1.5	20	0.44	0.4	4.0 x 0.8	1.56	38.2	2180	2320	2.2	36.5	1610	1750	500
1.5	24	0.44	0.4	4.0 x 0.8	1.56	42.2	2550	2710	2.2	40.5	1900	2060	500
1.5	30	0.44	0.4	4.0 x 0.8	1.72	45.0	3000	3210	2.2	42.9	2290	2500	500
1.5	37	0.44	0.5	4.0 x 0.8	1.72	48.7	3570	3830	2.4	46.8	2800	3060	500
2.5	2	0.53	0.3	4.0 x 0.8	1.40	20.4	650	670	1.8	18.3	340	360	1000
2.5	4	0.53	0.3	4.0 x 0.8	1.40	23.4	910	950	2.0	21.8	570	610	1000
2.5	5	0.53	0.3	4.0 x 0.8	1.40	25.4	1050	1100	2.0	23.8	690	740	1000
2.5	6	0.53	0.3	4.0 x 0.8	1.40	27.5	1190	1250	2.0	25.9	800	860	1000
2.5	8	0.53	0.3	4.0 x 0.8	1.40	30.8	1450	1530	2.0	29.2	1020	1100	500/1000
2.5	10	0.53	0.4	4.0 x 0.8	1.56	35.2	1790	1890	2.2	33.5	1270	1370	500/1000
2.5	12	0.53	0.4	4.0 x 0.8	1.56	36.4	2020	2140	2.2	34.7	1470	1590	500
2.5	14	0.53	0.4	4.0 x 0.8	1.56	38.2	2240	2380	2.2	36.5	1670	1810	500
2.5	16	0.53	0.4	4.0 x 0.8	1.56	40.2	2480	2640	2.2	38.5	1880	2040	500
2.5	19	0.53	0.4	4.0 x 0.8	1.56	42.4	2830	3010	2.2	40.7	2180	2370	500
2.5	20	0.53	0.4	4.0 x 0.8	1.72	45.1	3010	3210	2.2	43.0	2300	2500	500
2.5	24	0.53	0.5	4.0 x 0.8	1.88	50.5	3600	3840	2.4	48.3	2760	3000	500
2.5	30	0.53	0.5	4.0 x 0.8	1.88	53.4	4210	4510	2.6	51.6	3400	3700	500
2.5	37	0.53	0.5	4.0 x 0.8	2.04	57.9	5020	5390	2.6	55.8	4100	4470	400

For Cables of sizes or triads not listed above the product data is available on request
Larger Drum Lengths are possible against specific requirements on request

• Dimensions & Weights are representative figures and may vary

Weight & Dimension Data

300/500 VOLTS, SINGLE AND MULTI PAIR, STR. COPPER, TWO LAYERS OF GLASS MICA TAPES, EPR / SILICONE RUBBER INSULATED ALUMINIUM MYLAR TAPED OVERALL SHIELDED, ARMoured AND UNARMoured LOW SMOKE ZERO HALOGEN COMPOUND SHEATHED FIRE SURVIVAL INSTRUMENTATION CABLES GENERALLY AS PER IS

Area of conductor	No of pair	Minimum thickness of insulation	ARMoured CABLES						UNARMoured CABLES				Normal Drum Length with $\pm 5\%$
			Minimum thickness of inner sheath	Dimension of G.I. armour (wire/strip)	Minimum thickness of outer sheath	Nominal overall diameter	Approx. weight of cable - Silicone insulation	Approx. weight of cable - EPR insulation	Nominal thickness of outer sheath	Nominal overall diameter	Approx. weight of cable - Silicone insulation	Approx. weight of cable - EPR insulation	
mm ²		mm	mm	mm	mm	mm	kg/km	kg/km	mm	mm	kg/km	kg/km	m
0.5	1	0.44	0.3	0.9	1.24	12.5	255	255	1.8	10.6	110	105	1000
0.5	2	0.44	0.3	0.9	1.24	16.3	375	370	1.8	14.5	170	165	1000
0.5	4	0.44	0.3	0.9	1.24	18.4	475	465	1.8	16.5	235	225	1000
0.5	5	0.44	0.3	0.9	1.24	19.8	530	520	1.8	17.9	270	260	1000
0.5	6	0.44	0.3	0.9	1.24	21.3	590	580	1.8	19.4	310	295	1000
0.5	8	0.44	0.3	0.9	1.24	23.5	700	680	1.8	21.7	375	355	1000
0.5	10	0.44	0.3	0.9	1.24	26.3	820	790	1.8	24.4	450	425	1000
0.5	12	0.44	0.3	0.9	1.24	27.1	880	850	1.8	25.2	500	475	1000
0.5	16	0.44	0.3	4.0 x 0.8	1.40	29.9	1090	1050	1.8	27.9	620	580	1000
0.5	18	0.44	0.3	4.0 x 0.8	1.40	31.4	1170	1130	1.8	29.4	680	640	1000
0.5	19	0.44	0.3	4.0 x 0.8	1.40	31.4	1200	1150	1.8	29.4	700	660	1000
0.5	20	0.44	0.3	4.0 x 0.8	1.40	33.0	1260	1220	2.0	31.4	770	730	1000
0.5	24	0.44	0.3	4.0 x 0.8	1.40	36.4	1400	1390	2.0	34.8	900	850	1000
0.5	30	0.44	0.3	4.0 x 0.8	1.40	38.4	1630	1560	2.0	36.8	1060	990	1000
0.5	37	0.44	0.3	4.0 x 0.8	1.4	41.3	1870	1780	2.0	39.7	1260	1170	500/1000
0.75	1	0.44	0.3	0.9	1.24	12.9	270	270	1.8	11.0	120	115	1000
0.75	2	0.44	0.3	0.9	1.24	17.0	405	400	1.8	15.1	185	180	1000
0.75	4	0.44	0.3	0.9	1.24	19.3	520	510	1.8	17.4	265	255	1000
0.75	5	0.44	0.3	0.9	1.24	20.7	590	580	1.8	18.9	310	300	1000
0.75	6	0.44	0.3	0.9	1.24	22.3	660	640	1.8	20.5	355	340	1000
0.75	8	0.44	0.3	0.9	1.24	24.7	780	760	1.8	22.8	435	415	1000
0.75	10	0.44	0.3	4.0 X 0.8	1.40	27.8	940	910	1.8	25.8	520	500	1000
0.75	12	0.44	0.3	4.0 X 0.8	1.40	28.7	1030	1000	1.8	26.6	590	560	1000
0.75	16	0.44	0.3	4.0 X 0.8	1.40	31.5	1230	1190	2.0	29.9	760	720	1000
0.75	18	0.44	0.3	4.0 X 0.8	1.40	33.1	1330	1280	2.0	31.5	840	790	1000
0.75	19	0.44	0.3	4.0 X 0.8	1.40	33.1	1360	1310	2.0	31.5	870	820	1000
0.75	20	0.44	0.3	4.0 X 0.8	1.40	34.9	1430	1380	2.0	33.3	920	870	1000
0.75	24	0.44	0.3	4.0 X 0.8	1.40	38.4	1640	1570	2.0	36.8	1070	1010	1000
0.75	30	0.44	0.3	4.0 X 0.8	1.40	40.6	1890	1810	2.0	39.0	1270	1200	500/1000
0.75	37	0.44	0.3	4.0 X 0.8	1.4	43.8	2170	2080	2.0	42.1	1510	1420	500/1000
1.0	1	0.44	0.3	0.9	1.24	13.2	290	285	1.8	11.4	130	125	1000
1.0	2	0.44	0.3	0.9	1.24	17.6	430	425	1.8	15.7	205	200	1000
1.0	4	0.44	0.3	0.9	1.24	20.0	560	550	1.8	18.1	300	290	1000
1.0	5	0.44	0.3	0.9	1.24	21.5	640	630	1.8	19.7	350	335	1000
1.0	6	0.44	0.3	0.9	1.24	23.2	720	700	1.8	21.3	405	385	1000
1.0	8	0.44	0.3	0.9	1.24	25.7	850	830	1.8	23.9	500	475	1000
1.0	10	0.44	0.3	4.0 X 0.8	1.40	29.0	1040	1010	1.8	27.0	600	570	1000
1.0	12	0.44	0.3	4.0 X 0.8	1.40	29.9	1150	1110	1.8	27.8	680	650	1000
1.0	16	0.44	0.3	4.0 X 0.8	1.40	32.9	1370	1330	2.0	31.3	880	840	1000

Weight & Dimension Data

300/500 VOLTS, SINGLE AND MULTI PAIR, STR. COPPER, TWO LAYERS OF GLASS MICA TAPES, EPR / SILICONE RUBBER INSULATED ALUMINIUM MYLAR TAPED OVERALL SHIELDED, ARMoured AND UNARMoured LOW SMOKE ZERO HALOGEN COMPOUND SHEATHED FIRE SURVIVAL INSTRUMENTATION CABLES GENERALLY AS PER IS

Area of conductor	No of pair	Minimum thickness of insulation	ARMoured CABLES						UNARMoured CABLES				Normal Drum Length with $\pm 5\%$
			Minimum thickness of inner sheath	Dimension of G.I. armour (wire/strip)	Minimum thickness of outer sheath	Nominal overall diameter	Approx. weight of cable - Silicone insulation	Approx. weight of cable - EPR insulation	Nominal thickness of outer sheath	Nominal overall diameter	Approx. weight of cable - Silicone insulation	Approx. weight of cable - EPR insulation	
mm ²		mm	mm	mm	mm	mm	kg/km	kg/km	mm	mm	kg/km	kg/km	m
1.0	18	0.44	0.3	4.0 x 0.8	1.40	34.6	1490	1440	2.0	33.0	970	920	1000
1.0	19	0.44	0.3	4.0 x 0.8	1.40	34.6	1520	1470	2.0	33.0	1010	960	1000
1.0	20	0.44	0.3	4.0 x 0.8	1.40	36.4	1600	1550	2.0	34.8	1060	1010	1000
1.0	24	0.44	0.4	4.0 x 0.8	1.40	40.2	1860	1800	2.0	38.6	1250	1180	500/1000
1.0	30	0.44	0.3	4.0 x 0.8	1.40	42.5	2130	2040	2.0	40.9	1490	1410	500/1000
1.0	37	0.44	0.3	4.0 x 0.8	1.56	46.1	2490	2390	2.0	44.2	1770	1670	500/1000
1.5	1	0.44	0.3	0.9	1.24	13.8	315	310	1.8	12.0	145	140	1000
1.5	2	0.44	0.3	0.9	1.24	18.6	475	470	1.8	16.7	235	230	1000
1.5	4	0.44	0.3	0.9	1.24	21.2	640	630	1.8	19.3	355	340	1000
1.5	5	0.44	0.3	0.9	1.24	22.9	730	710	1.8	21.0	415	400	1000
1.5	6	0.44	0.3	0.9	1.24	24.7	820	800	1.8	22.8	480	460	1000
1.5	8	0.44	0.3	4.0 x 0.8	1.40	27.6	1010	990	1.8	25.6	600	580	1000
1.5	10	0.44	0.3	4.0 x 0.8	1.40	31.0	1190	1160	2.0	29.3	750	720	1000
1.5	12	0.44	0.3	4.0 x 0.8	1.40	31.9	1320	1280	2.0	30.3	860	820	1000
1.5	16	0.44	0.3	4.0 x 0.8	1.40	35.2	1590	1540	2.0	33.6	1080	1030	1000
1.5	18	0.44	0.3	4.0 x 0.8	1.40	37.1	1730	1670	2.0	35.4	1190	1130	1000
1.5	19	0.44	0.3	4.0 x 0.8	1.40	37.1	1770	1720	2.0	35.4	1240	1180	1000
1.5	20	0.44	0.3	4.0 x 0.8	1.40	39.1	1890	1830	2.0	37.5	1300	1240	500/1000
1.5	24	0.44	0.3	4.0 x 0.8	1.56	43.5	2200	2130	2.0	41.5	1530	1460	500/1000
1.5	30	0.44	0.3	4.0 x 0.8	1.56	46.0	2560	2470	2.0	44.0	1840	1750	500
1.5	37	0.44	0.4	4.0 x 0.8	1.56	49.8	3020	2910	2.2	48.1	2250	2140	500
2.5	1	0.53	0.3	0.9	1.24	15.1	365	360	1.8	13.2	180	175	1000
2.5	2	0.53	0.3	0.9	1.24	20.6	570	570	1.8	18.7	300	290	1000
2.5	4	0.53	0.3	0.9	1.24	23.6	790	770	1.8	21.7	465	450	1000
2.5	5	0.53	0.3	4.0 x 0.8	1.40	25.7	940	920	1.8	23.7	550	530	1000
2.5	6	0.53	0.3	4.0 x 0.8	1.40	27.9	1060	1030	1.8	25.8	640	620	1000
2.5	8	0.53	0.3	4.0 x 0.8	1.40	31.1	1300	1270	2.0	29.4	840	810	1000
2.5	10	0.53	0.3	4.0 x 0.8	1.40	35.0	1530	1490	2.0	33.3	1020	980	1000
2.5	12	0.53	0.3	4.0 x 0.8	1.40	36.1	1710	1660	2.0	34.5	1170	1120	1000
2.5	16	0.53	0.3	4.0 x 0.8	1.56	40.2	2100	2040	2.0	38.3	1480	1420	500/1000
2.5	18	0.53	0.3	4.0 x 0.8	1.56	42.4	2310	2240	2.0	40.4	1650	1570	500/1000
2.5	19	0.53	0.3	4.0 x 0.8	1.56	42.4	2380	2310	2.0	40.4	1710	1640	500/1000
2.5	20	0.53	0.4	4.0 x 0.8	1.56	44.9	2520	2440	2.2	43.2	1850	1770	500
2.5	24	0.53	0.4	4.0 x 0.8	1.56	49.7	2930	2830	2.2	48.0	2180	2080	500
2.5	30	0.53	0.4	4.0 x 0.8	1.56	52.6	3430	3310	2.2	50.9	2630	2510	500
2.5	37	0.53	0.4	4.0 x 0.8	1.72	57.1	4080	3930	2.2	55.1	3160	3010	500

For Cables of sizes or pairs not listed above the product data is available on request
Larger Drum Lengths are possible against specific requirements on request

• Dimensions & Weights are representative figures and may vary

Weight & Dimension Data



300/500 VOLTS, SINGLE AND MULTI TRIAD, STR. COPPER, TWO LAYERS OF GLASS MICA TAPES, EPR / SILICONE RUBBER INSULATED ALUMINIUM MYLAR TAPED OVERALL SHIELDED, ARMoured AND UNARMoured LOW SMOKE ZERO HALOGEN COMPOUND SHEATHED FIRE SURVIVAL INSTRUMENTATION CABLES GENERALLY AS PER IS

Area of conductor	No of triad	Minimum thickness of insulation	ARMoured CABLES						UNARMoured CABLES				Normal Drum Length with ± 5%
			Minimum thickness of inner sheath	Dimension of G.I. armour (wire/strip)	Minimum thickness of outer sheath	Nominal overall diameter	Approx. weight of cable - Silicone insulation	Approx. weight of cable - EPR insulation	Nominal thickness of outer sheath	Nominal overall diameter	Approx. weight of cable - Silicone insulation	Approx. weight of cable - EPR insulation	
mm ²		mm	mm	mm	mm	mm	kg/km	kg/km	mm	mm	kg/km	kg/km	m
0.5	1	0.44	0.3	0.9	1.24	12.9	280	275	1.8	11.1	125	120	1000
0.5	2	0.44	0.3	0.9	1.24	17.7	435	430	1.8	15.8	205	195	1000
0.5	4	0.44	0.3	0.9	1.24	20.1	570	550	1.8	18.2	295	285	1000
0.5	5	0.44	0.3	0.9	1.24	21.7	640	620	1.8	19.8	345	330	1000
0.5	6	0.44	0.3	0.9	1.24	23.4	720	690	1.8	21.5	400	375	1000
0.5	8	0.44	0.3	0.9	1.24	25.9	850	820	1.8	24.0	490	465	1000
0.5	10	0.44	0.3	4.0 x 0.8	1.40	29.2	1030	1000	1.8	27.1	590	560	1000
0.5	12	0.44	0.3	4.0 x 0.8	1.40	30.1	1140	1090	1.8	28.0	670	630	1000
0.5	14	0.44	0.3	4.0 x 0.8	1.40	31.5	1250	1200	1.8	29.5	750	700	500/1000
0.5	16	0.44	0.3	4.0 x 0.8	1.40	33.1	1360	1300	2.0	31.5	870	810	500/1000
0.5	19	0.44	0.3	4.0 x 0.8	1.40	34.8	1500	1440	2.0	33.2	990	920	500
0.5	20	0.44	0.3	4.0 x 0.8	1.40	36.7	1580	1510	2.0	35.1	1050	980	500
0.5	24	0.44	0.3	4.0 x 0.8	1.40	40.5	1840	1750	2.0	38.9	1220	1140	500
0.5	30	0.44	0.3	4.0 x 0.8	1.40	42.8	2100	1990	2.0	41.2	1460	1350	500
0.5	37	0.44	0.3	4.0 x 0.8	1.56	46.5	2460	2330	2.0	44.5	1740	1610	500
0.75	1	0.44	0.3	0.9	1.24	13.4	300	295	1.8	11.5	140	135	1000
0.75	2	0.44	0.3	0.9	1.24	18.5	470	465	1.8	16.6	230	225	1000
0.75	4	0.44	0.3	0.9	1.24	21.0	620	610	1.8	19.2	345	330	1000
0.75	5	0.44	0.3	0.9	1.24	22.7	710	690	1.8	20.9	405	385	1000
0.75	6	0.44	0.3	0.9	1.24	24.6	800	780	1.8	22.7	465	440	1000
0.75	8	0.44	0.3	4.0 X 0.8	1.24	27.1	970	940	1.8	25.4	580	550	1000
0.75	10	0.44	0.3	4.0 X 0.8	1.40	30.8	1170	1130	1.8	28.7	700	660	500/1000
0.75	12	0.44	0.3	4.0 X 0.8	1.40	31.7	1290	1240	2.0	30.1	830	780	500/1000
0.75	14	0.44	0.3	4.0 X 0.8	1.40	33.3	1420	1360	2.0	31.6	930	880	500/1000
0.75	16	0.44	0.3	4.0 X 0.8	1.40	35.0	1550	1490	2.0	33.4	1040	980	500
0.75	19	0.44	0.3	4.0 X 0.8	1.40	36.8	1730	1650	2.0	35.2	1190	1120	500
0.75	20	0.44	0.3	4.0 X 0.8	1.40	38.8	1840	1770	2.0	37.2	1250	1180	500
0.75	24	0.44	0.3	4.0 X 0.8	1.40	42.9	2110	2020	2.0	41.3	1470	1380	500
0.75	30	0.44	0.3	4.0 X 0.8	1.56	45.7	2480	2370	2.0	43.7	1760	1650	500
0.75	37	0.44	0.4	4.0 X 0.8	1.56	49.4	2910	2770	2.2	47.7	2160	2020	500
1.0	1	0.44	0.3	0.9	1.24	13.8	315	310	1.8	11.9	150	145	1000
1.0	2	0.44	0.3	0.9	1.24	19.2	510	500	1.8	17.3	255	250	1000
1.0	4	0.44	0.3	0.9	1.24	21.9	690	670	1.8	20.0	390	375	1000
1.0	5	0.44	0.3	0.9	1.24	23.7	780	760	1.8	21.8	460	440	1000
1.0	6	0.44	0.3	0.9	1.24	25.6	890	860	1.8	23.7	530	510	1000
1.0	8	0.44	0.3	4.0 X 0.8	1.40	28.6	1110	1080	1.8	26.6	670	640	1000
1.0	10	0.44	0.3	4.0 X 0.8	1.40	32.1	1300	1260	2.0	30.5	840	800	500/1000
1.0	12	0.44	0.3	4.0 X 0.8	1.40	33.1	1450	1400	2.0	31.5	960	910	500/1000
1.0	14	0.44	0.3	4.0 X 0.8	1.40	34.7	1600	1540	2.0	33.1	1080	1030	500

Weight & Dimension Data

300/500 VOLTS, SINGLE AND MULTI TRIAD, STR. COPPER, TWO LAYERS OF GLASS MICA TAPES, EPR / SILICONE RUBBER INSULATED ALUMINIUM MYLAR TAPED OVERALL SHIELDED, ARMoured AND UNARMoured LOW SMOKE ZERO HALOGEN COMPOUND SHEATHED FIRE SURVIVAL INSTRUMENTATION CABLES GENERALLY AS PER IS

Area of conductor	No of triad	Minimum thickness of insulation	ARMoured CABLES						UNARMoured CABLES				Normal Drum Length with \pm 5%
			Minimum thickness of inner sheath	Dimension of G.I. armour (wire/strip)	Minimum thickness of outer sheath	Nominal overall diameter	Approx. weight of cable - Silicone insulation	Approx. weight of cable - EPR insulation	Nominal thickness of outer sheath	Nominal overall diameter	Approx. weight of cable - Silicone insulation	Approx. weight of cable - EPR insulation	
mm ²		mm	mm	mm	mm	mm	kg/km	kg/km	mm	mm	kg/km	kg/km	m
1.0	16	0.44	0.3	4.0 x 0.8	1.40	36.6	1750	1680	2.0	35.0	1210	1140	500
1.0	19	0.44	0.3	4.0 x 0.8	1.40	38.5	1960	1880	2.0	36.9	1390	1310	500
1.0	20	0.44	0.3	4.0 x 0.8	1.40	40.6	2080	2000	2.0	39.0	1470	1390	500
1.0	24	0.44	0.3	4.0 x 0.8	1.40	44.9	2420	2320	2.0	43.3	1730	1630	500
1.0	30	0.44	0.3	4.0 x 0.8	1.56	47.8	2830	2700	2.0	45.9	2080	1960	500
1.0	37	0.44	0.4	4.0 x 0.8	1.56	51.8	3350	3190	2.2	50.1	2550	2390	500
1.5	1	0.44	0.3	0.9	1.24	14.4	350	345	1.8	12.6	175	170	1000
1.5	2	0.44	0.3	0.9	1.24	20.3	570	560	1.8	18.4	300	290	1000
1.5	4	0.44	0.3	0.9	1.24	23.2	780	770	1.8	21.3	465	450	1000
1.5	5	0.44	0.3	0.9	1.24	25.2	900	880	1.8	23.3	550	530	1000
1.5	6	0.44	0.3	4.0 x 0.8	1.40	27.4	1060	1030	1.8	25.4	640	620	1000
1.5	8	0.44	0.3	4.0 x 0.8	1.40	30.5	1280	1240	2.0	28.9	840	810	500/1000
1.5	10	0.44	0.3	4.0 x 0.8	1.40	34.4	1530	1490	2.0	32.8	1020	980	500
1.5	12	0.44	0.3	4.0 x 0.8	1.40	35.5	1690	1630	2.0	33.9	1170	1120	500
1.5	14	0.44	0.3	4.0 x 0.8	1.40	37.2	1890	1830	2.0	35.6	1330	1270	500
1.5	16	0.44	0.3	4.0 x 0.8	1.40	39.2	2080	2010	2.0	37.6	1490	1420	500
1.5	19	0.44	0.3	4.0 x 0.8	1.40	41.3	2340	2250	2.0	39.7	1720	1640	500
1.5	20	0.44	0.3	4.0 x 0.8	1.56	43.9	2510	2420	2.0	42.0	1820	1730	500
1.5	24	0.44	0.4	4.0 x 0.8	1.56	48.8	2940	2830	2.2	47.1	2190	2080	500
1.5	30	0.44	0.4	4.0 x 0.8	1.56	51.6	3440	3310	2.2	49.9	2640	2510	500
1.5	37	0.44	0.4	4.0 x 0.8	1.56	55.7	4030	3860	2.2	54.0	3180	3010	400
2.5	1	0.53	0.3	0.9	1.24	15.7	415	410	1.8	13.9	220	215	1000
2.5	2	0.53	0.3	0.9	1.24	22.6	690	680	1.8	20.7	390	375	1000
2.5	4	0.53	0.3	4.0 x 0.8	1.40	26.1	1010	990	1.8	24.1	630	600	1000
2.5	5	0.53	0.3	4.0 x 0.8	1.40	28.4	1190	1160	2.0	26.8	780	750	1000
2.5	6	0.53	0.3	4.0 x 0.8	1.40	30.8	1350	1310	2.0	29.2	910	870	500/1000
2.5	8	0.53	0.3	4.0 x 0.8	1.40	34.5	1670	1620	2.0	32.8	1150	1100	500
2.5	10	0.53	0.3	4.0 x 0.8	1.40	38.9	1990	1930	2.0	37.3	1410	1340	500
2.5	12	0.53	0.3	4.0 x 0.8	1.56	40.5	2270	2190	2.0	38.6	1630	1550	500
2.5	14	0.53	0.3	4.0 x 0.8	1.56	42.5	2520	2440	2.0	40.6	1850	1770	500
2.5	16	0.53	0.4	4.0 x 0.8	1.56	45.1	2800	2700	2.2	43.4	2130	2030	500
2.5	19	0.53	0.4	4.0 x 0.8	1.56	47.5	3190	3070	2.2	45.8	2470	2350	500
2.5	20	0.53	0.4	4.0 x 0.8	1.56	50.2	3380	3250	2.2	48.5	2600	2480	500
2.5	24	0.53	0.4	4.0 x 0.8	1.72	55.9	3970	3830	2.2	53.9	3080	2930	400
2.5	30	0.53	0.5	4.0 x 0.8	1.72	59.5	4740	4560	2.4	57.6	3790	3610	400
2.5	37	0.53	0.5	4.0 x 0.8	1.88	64.6	5660	5430	2.4	62.4	4580	4350	400

For Cables of sizes or triads not listed above the product data is available on request
Larger Drum Lengths are possible against specific requirements on request

• Dimensions & Weights are representative figures and may vary

Weight & Dimension Data



300/500 VOLTS, MULTI PAIR, STR. COPPER, TWO LAYERS OF GLASS MICA TAPES, EPR / SILICONE RUBBER INSULATED, ALUMINIUM MYLAR TAPED INDIVIDUAL AND OVERALL SHIELDED, ARMoured AND UNARMoured LOW SMOKE ZERO HALOGEN COMPOUND SHEATHED FIRE SURVIVAL INSTRUMENTATION CABLES GENERALLY AS PER IS

Area of conductor	No of pair	Minimum thickness of insulation	ARMoured CABLES						UNARMoured CABLES				Normal Drum Length with $\pm 5\%$
			Minimum thickness of inner sheath	Dimension of G.I. armour (wire/strip)	Minimum thickness of outer sheath	Nominal overall diameter	Approx. weight of cable - Silicone insulation	Approx. weight of cable - EPR insulation	Nominal thickness of outer sheath	Nominal overall diameter	Approx. weight of cable - Silicone insulation	Approx. weight of cable - EPR insulation	
mm ²		mm	mm	mm	mm	mm	kg/km	kg/km	mm	mm	kg/km	kg/km	m
0.5	2	0.44	0.3	0.9	1.24	17.7	430	425	1.8	15.8	200	195	1000
0.5	4	0.44	0.3	0.9	1.24	20.1	560	550	1.8	18.2	285	275	1000
0.5	5	0.44	0.3	0.9	1.24	21.6	620	610	1.8	19.8	335	320	1000
0.5	6	0.44	0.3	0.9	1.24	23.3	700	690	1.8	21.5	385	370	1000
0.5	8	0.44	0.3	0.9	1.24	25.9	830	810	1.8	24.0	470	455	1000
0.5	10	0.44	0.3	4.0 x 0.8	1.40	29.1	1010	980	1.8	27.1	570	540	1000
0.5	12	0.44	0.3	4.0 x 0.8	1.40	30.0	1110	1080	1.8	28.0	640	610	1000
0.5	16	0.44	0.3	4.0 x 0.8	1.40	33.1	1320	1280	2.0	31.5	830	790	500
0.5	18	0.44	0.3	4.0 x 0.8	1.40	34.8	1430	1380	2.0	33.2	910	870	500
0.5	19	0.44	0.3	4.0 x 0.8	1.40	34.8	1460	1410	2.0	33.2	940	900	500
0.5	20	0.44	0.3	4.0 x 0.8	1.40	36.6	1530	1490	2.0	35.0	1000	950	500
0.5	24	0.44	0.3	4.0 x 0.8	1.40	40.4	1780	1720	2.0	38.8	1170	1110	500
0.5	30	0.44	0.3	4.0 x 0.8	1.40	42.7	2020	1950	2.0	41.1	1380	1310	500
0.5	37	0.44	0.3	4.0 x 0.8	1.56	46.4	2370	2280	2.0	44.5	1650	1560	500
0.75	2	0.44	0.3	0.9	1.24	18.4	460	455	1.8	16.6	220	215	1000
0.75	4	0.44	0.3	0.9	1.24	21.0	600	590	1.8	19.1	320	310	1000
0.75	5	0.44	0.3	0.9	1.24	22.6	680	670	1.8	20.8	375	365	1000
0.75	6	0.44	0.3	0.9	1.24	24.5	770	750	1.8	22.6	430	415	1000
0.75	8	0.44	0.3	4.0 x 0.8	1.40	27.3	950	930	1.8	25.3	540	520	1000
0.75	10	0.44	0.3	4.0 x 0.8	1.40	30.6	1110	1090	2.0	29.0	670	650	500/1000
0.75	12	0.44	0.3	4.0 x 0.8	1.40	31.6	1230	1190	2.0	30.0	760	730	500/1000
0.75	16	0.44	0.3	4.0 x 0.8	1.40	34.8	1470	1420	2.0	33.2	950	910	1000
0.75	18	0.44	0.3	4.0 x 0.8	1.40	36.6	1590	1540	2.0	35.0	1050	1000	500
0.75	19	0.44	0.3	4.0 x 0.8	1.40	36.6	1630	1580	2.0	35.0	1090	1040	500
0.75	20	0.44	0.3	4.0 x 0.8	1.40	38.6	1710	1660	2.0	37.0	1150	1100	500
0.75	24	0.44	0.3	4.0 x 0.8	1.56	43.0	2010	1950	2.0	41.0	1340	1280	500
0.75	30	0.44	0.3	4.0 x 0.8	1.56	45.4	2330	2250	2.0	43.5	1600	1530	500
0.75	37	0.44	0.4	4.0 x 0.8	1.56	49.2	2710	2620	2.2	47.5	1960	1870	500
1.0	2	0.44	0.3	0.9	1.24	19.1	490	485	1.8	17.2	240	235	1000
1.0	4	0.44	0.3	0.9	1.24	21.7	650	640	1.8	19.9	355	345	1000
1.0	5	0.44	0.3	0.9	1.24	23.5	740	730	1.8	21.6	420	405	1000
1.0	6	0.44	0.3	0.9	1.24	25.4	830	820	1.8	23.5	480	465	1000
1.0	8	0.44	0.3	4.0 x 0.8	1.40	28.4	1040	1020	1.8	26.4	600	580	1000
1.0	10	0.44	0.3	4.0 x 0.8	1.40	31.9	1220	1190	2.0	30.3	750	730	500/1000
1.0	12	0.44	0.3	4.0 x 0.8	1.40	32.9	1350	1310	2.0	31.3	860	820	500
1.0	16	0.44	0.3	4.0 x 0.8	1.40	36.3	1610	1570	2.0	34.7	1080	1030	500

Weight & Dimension Data

300/500 VOLTS, MULTI PAIR, STR. COPPER, TWO LAYERS OF GLASS MICA TAPES, EPR / SILICONE RUBBER INSULATED, ALUMINIUM MYLAR TAPED INDIVIDUAL AND OVERALL SHIELDED, ARMoured AND UNARMoured LOW SMOKE ZERO HALOGEN COMPOUND SHEATHED FIRE SURVIVAL INSTRUMENTATION CABLES GENERALLY AS PER IS

Area of conductor	No of pair	Minimum thickness of insulation	ARMoured CABLES						UNARMoured CABLES				Normal Drum Length with \pm 5%
			Minimum thickness of inner sheath	Dimension of G.I. armour (wire/strip)	Minimum thickness of outer sheath	Nominal overall diameter	Approx. weight of cable - Silicone insulation	Approx. weight of cable - EPR insulation	Nominal thickness of outer sheath	Nominal overall diameter	Approx. weight of cable - Silicone insulation	Approx. weight of cable - EPR insulation	
mm ²		mm	mm	mm	mm	mm	kg/km	kg/km	mm	mm	kg/km	kg/km	m
1.0	18	0.44	0.3	4.0 x 0.8	1.40	38.2	1750	1700	2.0	36.6	1190	1140	500
1.0	19	0.44	0.3	4.0 x 0.8	1.40	38.2	1800	1750	2.0	36.6	1230	1180	500
1.0	20	0.44	0.3	4.0 x 0.8	1.40	40.3	1910	1860	2.0	38.7	1300	1250	500
1.0	24	0.44	0.3	4.0 x 0.8	1.56	44.9	2220	2160	2.0	43.0	1530	1460	500
1.0	30	0.44	0.4	4.0 x 0.8	1.56	47.7	2600	2520	2.2	46.0	1880	1790	500
1.0	37	0.44	0.4	4.0 x 0.8	1.56	51.4	3040	2940	2.2	49.7	2240	2140	500
1.5	2	0.44	0.3	0.9	1.24	20.1	540	530	1.8	18.3	270	265	1000
1.5	4	0.44	0.3	0.9	1.24	23.0	720	710	1.8	21.1	410	400	1000
1.5	5	0.44	0.3	4.0 x 0.8	1.24	24.7	850	840	1.8	23.1	485	470	1000
1.5	6	0.44	0.3	4.0 x 0.8	1.40	27.2	980	960	1.8	25.1	560	550	1000
1.5	8	0.44	0.3	4.0 x 0.8	1.40	30.3	1170	1150	2.0	28.6	730	710	500/1000
1.5	10	0.44	0.3	4.0 x 0.8	1.40	34.0	1400	1370	2.0	32.4	890	860	500
1.5	12	0.44	0.3	4.0 x 0.8	1.40	35.1	1530	1490	2.0	33.5	1010	980	500
1.5	16	0.44	0.3	4.0 x 0.8	1.40	38.9	1870	1820	2.0	37.2	1280	1230	500
1.5	18	0.44	0.3	4.0 x 0.8	1.40	40.9	2030	1970	2.0	39.3	1410	1360	500
1.5	19	0.44	0.3	4.0 x 0.8	1.40	40.9	2080	2030	2.0	39.3	1470	1410	500
1.5	20	0.44	0.3	4.0 x 0.8	1.56	43.5	2220	2160	2.0	41.6	1550	1490	500
1.5	24	0.44	0.4	4.0 x 0.8	1.56	48.3	2620	2550	2.2	46.6	1870	1800	500
1.5	30	0.44	0.4	4.0 x 0.8	1.56	51.1	3020	2930	2.2	49.4	2250	2160	500
1.5	37	0.44	0.4	4.0 x 0.8	1.56	55.2	3540	3430	2.2	53.3	2690	2580	400
2.5	2	0.53	0.3	0.9	1.24	22.3	640	630	1.8	20.4	340	330	1000
2.5	4	0.53	0.3	4.0 x 0.8	1.40	25.8	920	900	1.8	23.8	530	510	1000
2.5	5	0.53	0.3	4.0 x 0.8	1.40	28.0	1070	1050	2.0	26.4	660	640	1000
2.5	6	0.53	0.3	4.0 x 0.8	1.40	30.4	1200	1180	2.0	28.8	760	740	500/1000
2.5	8	0.53	0.3	4.0 x 0.8	1.40	34.0	1450	1420	2.0	32.4	960	930	500
2.5	10	0.53	0.3	4.0 x 0.8	1.40	38.4	1730	1690	2.0	36.8	1170	1130	500
2.5	12	0.53	0.3	4.0 x 0.8	1.56	40.0	1960	1910	2.0	38.0	1340	1290	500
2.5	16	0.53	0.4	4.0 x 0.8	1.56	44.5	2420	2360	2.2	42.8	1750	1680	500
2.5	18	0.53	0.4	4.0 x 0.8	1.56	46.8	2660	2590	2.2	45.1	1940	1860	500
2.5	19	0.53	0.4	4.0 x 0.8	1.56	46.8	2740	2660	2.2	45.1	2020	1940	500
2.5	20	0.53	0.4	4.0 x 0.8	1.56	49.5	2880	2800	2.2	47.8	2130	2050	500
2.5	24	0.53	0.4	4.0 x 0.8	1.72	55.2	3410	3310	2.2	53.1	2510	2410	400
2.5	30	0.53	0.5	4.0 x 0.8	1.72	58.6	4010	3880	2.4	56.8	3080	2960	400
2.5	37	0.53	0.5	4.0 x 0.8	1.88	63.7	4760	4610	2.4	61.5	3700	3550	400

For Cables of sizes or pairs not listed above the product data is available on request
Larger Drum Lengths are possible against specific requirements on request

• Dimensions & Weights are representative figures and may vary

Weight & Dimension Data



300/500 VOLTS, MULTI TRIAD, STR. COPPER, TWO LAYERS OF GLASS MICA TAPES, EPR / SILICONE RUBBER INSULATED, ALUMINIUM MYLAR TAPED INDIVIDUAL AND OVERALL SHIELDED, ARMoured AND UNARMoured LOW SMOKE ZERO HALOGEN COMPOUND SHEATHED FIRE SURVIVAL INSTRUMENTATION CABLES GENERALLY AS PER IS

Area of conductor	No of triad	Minimum thickness of insulation	ARMoured CABLES						UNARMoured CABLES				Normal Drum Length with \pm 5%
			Minimum thickness of inner sheath	Dimension of G.I. armour (wire/strip)	Minimum thickness of outer sheath	Nominal overall diameter	Approx. weight of cable - Silicone insulation	Approx. weight of cable - EPR insulation	Nominal thickness of outer sheath	Nominal overall diameter	Approx. weight of cable - Silicone insulation	Approx. weight of cable - EPR insulation	
mm ²		mm	mm	mm	mm	mm	kg/km	kg/km	mm	mm	kg/km	kg/km	m
0.5	2	0.44	0.3	0.9	1.24	19.2	490	485	1.8	17.3	240	230	1000
0.5	4	0.44	0.3	0.9	1.24	21.9	650	630	1.8	20.0	350	340	1000
0.5	5	0.44	0.3	0.9	1.24	23.7	740	720	1.8	21.8	415	395	1000
0.5	6	0.44	0.3	0.9	1.24	25.6	830	810	1.8	23.8	475	455	1000
0.5	8	0.44	0.3	4.0 x 0.8	1.40	28.7	1030	1000	1.8	26.6	590	560	1000
0.5	10	0.44	0.3	4.0 x 0.8	1.40	32.2	1210	1170	2.0	30.6	750	710	500
0.5	12	0.44	0.3	4.0 x 0.8	1.40	33.2	1330	1290	2.0	31.6	840	800	500
0.5	14	0.44	0.3	4.0 x 0.8	1.40	34.8	1460	1420	2.0	33.2	950	900	500
0.5	16	0.44	0.3	4.0 x 0.8	1.40	36.7	1600	1540	2.0	35.1	1060	1000	500
0.5	19	0.44	0.3	4.0 x 0.8	1.40	38.6	1780	1710	2.0	37.0	1210	1150	500
0.5	20	0.44	0.3	4.0 x 0.8	1.40	40.7	1890	1820	2.0	39.1	1280	1210	500
0.5	24	0.44	0.3	4.0 x 0.8	1.56	45.3	2220	2140	2.0	43.4	1500	1420	500
0.5	30	0.44	0.4	4.0 x 0.8	1.56	48.2	2570	2460	2.2	46.5	1840	1740	500
0.5	37	0.44	0.4	4.0 x 0.8	1.56	51.9	3000	2870	2.2	50.2	2200	2070	500
0.75	2	0.44	0.3	0.9	1.24	20.1	530	530	1.8	18.2	265	260	1000
0.75	4	0.44	0.3	0.9	1.24	23.0	710	700	1.8	21.1	400	385	1000
0.75	5	0.44	0.3	0.9	1.24	24.9	820	800	1.8	23.0	475	455	1000
0.75	6	0.44	0.3	4.0 x 0.8	1.40	27.1	960	940	1.8	25.1	550	520	1000
0.75	8	0.44	0.3	4.0 x 0.8	1.40	30.2	1150	1120	2.0	28.6	710	680	500/1000
0.75	10	0.44	0.3	4.0 x 0.8	1.40	33.9	1350	1310	2.0	32.3	860	820	500
0.75	12	0.44	0.3	4.0 x 0.8	1.40	35.0	1490	1450	2.0	33.4	980	930	500
0.75	14	0.44	0.3	4.0 x 0.8	1.40	36.7	1640	1590	2.0	35.1	1110	1050	500
0.75	16	0.44	0.3	4.0 x 0.8	1.40	38.7	1820	1760	2.0	37.1	1230	1170	500
0.75	19	0.44	0.3	4.0 x 0.8	1.40	40.8	2030	1960	2.0	39.2	1420	1350	500
0.75	20	0.44	0.3	4.0 x 0.8	1.56	43.3	2170	2090	2.0	41.4	1500	1420	500
0.75	24	0.44	0.4	4.0 x 0.8	1.56	48.1	2530	2440	2.2	46.4	1810	1710	500
0.75	30	0.44	0.4	4.0 x 0.8	1.56	50.9	2940	2820	2.2	49.2	2160	2050	500
0.75	37	0.44	0.4	4.0 x 0.8	1.56	55.0	3440	3300	2.2	53.3	2590	2450	500
1.0	2	0.44	0.3	0.9	1.24	20.8	570	560	1.8	18.9	290	285	1000
1.0	4	0.44	0.3	0.9	1.24	23.8	780	760	1.8	22.0	450	435	1000
1.0	5	0.44	0.3	0.9	1.24	25.9	890	870	1.8	24.0	530	510	1000
1.0	6	0.44	0.3	4.0 x 0.8	1.40	28.2	1060	1030	1.8	26.1	620	590	1000
1.0	8	0.44	0.3	4.0 x 0.8	1.40	31.4	1270	1240	2.0	29.8	810	770	500/1000
1.0	10	0.44	0.3	4.0 x 0.8	1.40	35.4	1490	1450	2.0	33.8	980	930	500
1.0	12	0.44	0.3	4.0 x 0.8	1.40	36.6	1650	1610	2.0	34.9	1120	1070	500
1.0	14	0.44	0.3	4.0 x 0.8	1.40	38.4	1830	1770	2.0	36.7	1260	1210	500

Weight & Dimension Data

300/500 VOLTS, MULTI TRIAD, STR. COPPER, TWO LAYERS OF GLASS MICA TAPES, EPR / SILICONE RUBBER INSULATED, ALUMINIUM MYLAR TAPED INDIVIDUAL AND OVERALL SHIELDED, ARMoured AND UNARMoured LOW SMOKE ZERO HALOGEN COMPOUND SHEATHED FIRE SURVIVAL INSTRUMENTATION CABLES GENERALLY AS PER IS

Area of conductor	No of triad	Minimum thickness of insulation	ARMoured CABLES						UNARMoured CABLES				Normal Drum Length with ± 5%
			Minimum thickness of inner sheath	Dimension of G.I. armour (wire/strip)	Minimum thickness of outer sheath	Nominal overall diameter	Approx. weight of cable - Silicone insulation	Approx. weight of cable - EPR insulation	Nominal thickness of outer sheath	Nominal overall diameter	Approx. weight of cable - Silicone insulation	Approx. weight of cable - EPR insulation	
mm ²		mm	mm	mm	mm	mm	kg/km	kg/km	mm	mm	kg/km	kg/km	m
1.0	16	0.44	0.3	4.0 x 0.8	1.40	40.4	2030	1960	2.0	38.8	1410	1350	500
1.0	19	0.44	0.3	4.0 x 0.8	1.40	42.6	2270	2190	2.0	41.0	1630	1550	500
1.0	20	0.44	0.3	4.0 x 0.8	1.56	45.3	2440	2360	2.0	43.4	1720	1640	500
1.0	24	0.44	0.4	4.0 x 0.8	1.56	50.3	2850	2750	2.2	48.6	2070	1980	500
1.0	30	0.44	0.4	4.0 x 0.8	1.56	53.3	3320	3200	2.2	51.6	2490	2370	500
1.0	37	0.44	0.4	4.0 x 0.8	1.56	57.5	3890	3740	2.2	55.8	2990	2840	400
1.5	2	0.44	0.3	0.9	1.24	22.0	630	620	1.8	20.2	335	330	1000
1.5	4	0.44	0.3	4.0 x 0.8	1.24	25.1	890	880	1.8	23.4	530	510	1000
1.5	5	0.44	0.3	4.0 x 0.8	1.40	27.7	1040	1020	1.8	25.6	630	610	1000
1.5	6	0.44	0.3	4.0 x 0.8	1.40	30.0	1200	1170	2.0	28.4	760	730	500/1000
1.5	8	0.44	0.3	4.0 x 0.8	1.40	33.5	1450	1410	2.0	31.9	960	920	500
1.5	10	0.44	0.3	4.0 x 0.8	1.40	37.8	1730	1680	2.0	36.2	1160	1120	500
1.5	12	0.44	0.3	4.0 x 0.8	1.40	39.1	1930	1870	2.0	37.5	1340	1290	500
1.5	14	0.44	0.3	4.0 x 0.8	1.56	41.3	2160	2100	2.0	39.4	1520	1460	500
1.5	16	0.44	0.3	4.0 x 0.8	1.56	43.6	2400	2330	2.0	41.7	1710	1630	500
1.5	19	0.44	0.4	4.0 x 0.8	1.56	46.2	2710	2630	2.2	44.5	2020	1930	500
1.5	20	0.44	0.4	4.0 x 0.8	1.56	48.7	2870	2780	2.2	47.0	2130	2040	500
1.5	24	0.44	0.4	4.0 x 0.8	1.56	54.0	3330	3230	2.2	52.3	2510	2400	400
1.5	30	0.44	0.4	4.0 x 0.8	1.72	57.6	3950	3820	2.2	55.5	3030	2890	400
1.5	37	0.44	0.5	4.0 x 0.8	1.72	62.4	4680	4510	2.4	60.5	3700	3540	400
2.5	2	0.53	0.3	4.0 x 0.8	1.40	24.7	790	780	1.8	22.6	430	415	1000
2.5	4	0.53	0.3	4.0 x 0.8	1.40	28.5	1140	1110	2.0	26.8	720	700	1000
2.5	5	0.53	0.3	4.0 x 0.8	1.40	31.0	1330	1300	2.0	29.4	860	830	500/1000
2.5	6	0.53	0.3	4.0 x 0.8	1.40	33.7	1500	1460	2.0	32.1	1010	970	500
2.5	8	0.53	0.3	4.0 x 0.8	1.40	37.8	1840	1800	2.0	36.2	1280	1230	500
2.5	10	0.53	0.4	4.0 x 0.8	1.56	43.3	2250	2190	2.2	41.6	1600	1540	500
2.5	12	0.53	0.4	4.0 x 0.8	1.56	44.7	2520	2450	2.2	43.0	1850	1780	500
2.5	14	0.53	0.4	4.0 x 0.8	1.56	47.0	2830	2750	2.2	45.3	2110	2020	500
2.5	16	0.53	0.4	4.0 x 0.8	1.56	49.6	3120	3020	2.2	47.9	2370	2270	500
2.5	19	0.53	0.4	4.0 x 0.8	1.56	52.3	3550	3430	2.2	50.6	2750	2630	500
2.5	20	0.53	0.4	4.0 x 0.8	1.72	55.7	3790	3670	2.2	53.6	2890	2770	400
2.5	24	0.53	0.5	4.0 x 0.8	1.88	62.3	4510	4360	2.4	60.1	3480	3340	400
2.5	30	0.53	0.5	4.0 x 0.8	1.88	66.0	5330	5150	2.6	64.2	4290	4100	400
2.5	37	0.53	0.5	4.0 x 0.8	2.04	71.6	6330	6100	2.6	69.6	5160	4940	400

For Cables of sizes or triads not listed above the product data is available on request
Larger Drum Lengths are possible against specific requirements on request

• Dimensions & Weights are representative figures and may vary

Thermocouple Extension and Compensating Cables

A typical system to measure temperature in a plant is with thermocouples. This system consists of a sensor (thermocouple), a cable to transmit the signal, and a measuring device, normally in a central control room.

Sensors are made by different materials, and conductors in thermocouple cables must be chosen according to the type of sensors used. The cables connect the measuring junction (normally defined hot junction) to the reference junction (defined cold junction): the difference in temperature between these two points generates an electro motive force (EMF) that is then converted in temperature by a measuring device.

In case the material used for conductors has the same chemical composition as the corresponding thermocouple; the cable is defined Thermocouple extension cable. This is applicable to type J.T and E thermocouple.

In case of costly metals used for thermocouples, less expensive Metals having the same EMF characteristic as that of Thermocouple metals between 0 to 100°C are used for connecting the thermocouple to the instruments. These connecting wires are called Thermocouple compensating cables.

The following junctions i.e. Thermocouples have been standardized the world over:

Code	+ve leg	-ve leg	Nominal e.m.f. (microvolts 0°C / 100°C)	Recommended working temp. in celsius	Remarks
K	Chromel (alloy of Chromium & Nickel)	Alumel (alloy of Aluminium & Nickel)	4.10	0°C to 100°C	Most commonly used
T	Copper	Constantan (alloy of Copper & Nickel)	4.28	-185°C to 300°C	For low temp. & cryogenic applications
J	Iron	Constantan	5.27	20°C to 700°C	Used in reducing Atmosphere
E	Chromel	Constantan	6.32	0°C to 800°C	Highest EMF output
R	Platinum +13% Rhodium	Platinum	0.647	0°C to 1600°C	Very high temp. measurements
S	Platinum +10% Rhodium	Platinum	0.645	0°C to 1500°C	Very high temp. measurements
B	Platinum +30% Rhodium	Platinum +6% Rhodium	0.033	100°C to 1500°C	Mainly used in glass industry

Now in a process plant the measuring instrument may be quite far from the thermocouple cable.

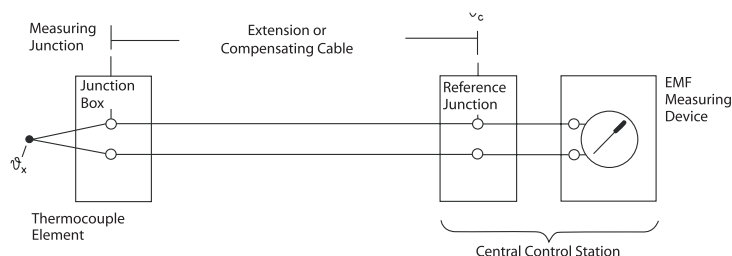

CONDUCTOR SIZE FOR EXTENTION WIRES & COMPENSATING CABLES

Today direct measurement of emf is the most popular method and in this case the size of the connecting wires has no bearing on the accuracy of the measurement and hence the size of the conductor is to be chosen keeping in mind the mechanical stability.

Conductor size is selected according to the length of the connection or the presence of Electromagnetic noises: the greater the length or the greater the noises, the largest shall be the size of the conductor.

















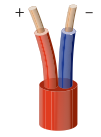

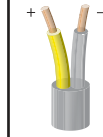
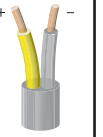
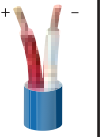

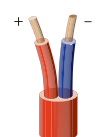
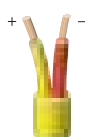
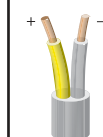
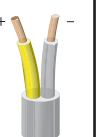
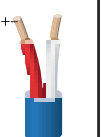

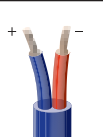
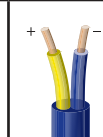
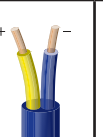
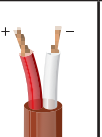



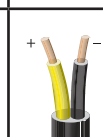
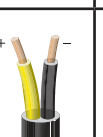
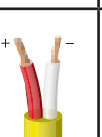



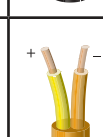
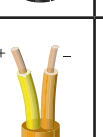



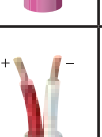

Standard sizes are 20 AWG (about 0.5 mm²), 18 AWG (about 1 mm²) and 16 AWG (about 1.3 mm²), solid or stranded conductors

Solid wire construction is recommended for extension wire and compensating cable, as in case of multi strand conductor if there is a slight variation in the composition of the strands, they form their own internal thermocouple and may add to the error.

The adjoining table gives the colour code for extension wires and compensating cables as per different standards adopted by different countries.

In India mostly ANSI (American National Standard Institute) specification MC 96.1 is followed.

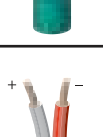
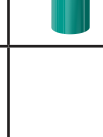
Colour Codes for Thermocouple Extension and Compensating Cable

THERMOCOUPLE	EXTENSION LEAD	COMPENSATING CABLE	+Ve LEG	-Ve LEG	INTERNATIONAL IEC 584.3	BRITISH B.S 1843 	AMERICAN ANSI 	GERMAN DIN 43714 	FRENCH NFC 42324 	JAPANESE JIS C 1610 	PERMISSIBLE ERROR AS PER ANSI AT 100°C TYPE
K	KX		CHROMEL	ALUMEL							± 2.2°C
		KCB	COPPER	CONSTANTAN							
T	TX		COPPER	CONSTANTAN							± 1.0°C
J	JX		IRON	CONSTANTAN							± 2.2°C
E	EX		CHROMEL	CONSTANTAN							± 1.7°C
R		RCA	COPPER	CUPRONIC							± 5°C
S		SCA	COPPER	CUPRONIC							± 5°C
B		BC	COPPER	COPPER							—

Fire Resistant / Fire Survival Instrumentation Cables

The cables which are used in the Power, Control or Signal Circuit of emergency equipment's shall be Fire Resistant to ensure higher safety and performance in the event of fire.

This critical equipment's such as Alarm, Lift Power Supply, Emergency Lights, Exit Lights, Water Spray system and other important functions are connected with these cables.

ADVANTAGES OF POLYCAB FIRE RESISTANT (FIRE SURVIVAL) -FSCABLE WITH LSZH SHEATHING

- Maintains the circuit in operation for few hours to ensure emergency operation in the event of fire.
- Ensures Power availability during fire.
- Can save life and damages in the event of fire.
- Does not emit toxic gases hence safe to human and electronic equipment's
- Low and white smoke does not affect visibility in enclosed areas
- All cable components are non-toxic, having low emission of smoke and acidic nature.

TYPICAL CONSTRUCTION -FIRE RESISTANT/ FIRE SURVIVALCABLES



1. **Conductor:** Annealed Plain / Tinned Copper / Aluminum -IS:8130 / IEC 60228/ BS 6360.
2. **Fire Barrier:** 2 Layers of Glass Mica Tape.
3. **Insulation:** EPR or XLPE or Silicone Rubber.
4. **Fire Barrier Tape:** Glass Fiber Tape over laid up cores.
5. **Inner Sheath:** FRLS / LSZH
6. **Armour:** IS:3975, BS:7846
7. **Outer Sheath:** FRLS PVC ST 2, LSZH

Fire Resistant or Fire Survival Cables shall be with LSZH / LSOH / ZHFR sheathing for better performance under fire.

PERFORMANCE CHARACTERISTIC OF DIFFERENT TYPES OF CABLES UNDER FIRE

Sl. No.	Cable Type	Fire Characteristics	Application	Properties
01	PVC Cables/XLPE Cables	Flame Retardant (FR)	Where flame retardance is desirable, but smoke and acid gas evolution is not considered to pose a serious hazard.	IEC-60332-1, 60332-3 SS-42414 75 F3 & ASTM-D-2863 -Limiting Oxygen Index -Min. 29%. Temperature Index min. 250°C.
02	Low emission PVC Cables, XLPE Cables	Flame Retardant, Low Smoke & Reduced Halogen (FRLSH)	In situations where reduced levels of smoke and corrosive gases are needed, compared to ordinary PVC or chlorinated polymer based cables.	IEC -60332 -1, 60332 -3, SS -424 -1475 ASTM-D-2843, Smoke Density Rating: Max. 60% ASTM-D-2863, Limiting Oxygen Index : Min. 29% ASTM-D-2863, Temperature min 250°C IEC-60754-1 (Max. HCL Gas Emission): 20% by weight
03	Low Fire Hazard Low Smoke, Zero Halogen. (LSOH)	Flame Retardant Low smoke & Acid Gas Emission.	For installation in areas where smoke and acid gas evolution could pose a hazard to personnel or sensitive equipment, but where circuit integrity is not needed.	IEC-60332-1, 60332-3, SS-424-1475 ASTM-D-2843, Smoke Density Rating: Max. 20% IEC-61034, Min. Light Transmission: 80% ASTMD-2863, Limiting Oxygen Index: Min. 30% IEC-60754-2, Max. HCL :0.5% Toxicity Index: Less than 5
04	Limited Circuit Integrity reduced hazard -Halogen contents (FRLS,FS)	Fire Resistance / Fire Survival/ Flame Retardant Low Smoke (FRLS-H)& Reduced Halogen	For maintaining essential circuits such as emergency lighting and fire alarms for shorter time periods. Increased hazard from smoke and acid gas emission.	IEC-60331, 60332-1, 60332-3, SS-424 1475 ASTM-D-2843, Smoke Density Rating: 60% ASTMD-2863, Limiting Oxygen Index: Min. 29% IEC-60754-1 (Max. HCL Gas Emission): 20%
05	Limited Circuit Integrity -Low Fire & Gas Hazards. (FS Cable, (LSOH)	Fire Resistant / Fire Survival/ Flame Retardant Low Smoke & Zero Halogen.	For maintaining essential circuits such as emergency lighting and fire alarms for shorter time periods. Reduced hazard from cable combustion.	IEC-60331, 60332-1, 60332-3, SS-424 1475 ASTM-D-2843, Smoke Density Rating: Max.20% IEC-61034, Min. Light Transmission: 80% ASTMD-2863, Limiting Oxygen Index: Min. 30% IEC-60754-2, Max. HCL :0.5% Toxicity Index: Less than 5 BS-6387

Properties of Fire Performance in Cables

PROPERTIES COVERED		TYPES					
		FR		FRLS		ZHLS	
		Flame Retardant		Flame Retardant Low Smoke		Zero Halogen Low Smoke	
PROPERTIES	REF. STANDARD	Applicable	Limit	Applicable	Limit	Applicable	Limit
Oxygen Index	ASTMD-2863	✓	29% (Min.)	✓	29% (Min.)	✓	30% (Min.)
Temperature Index	ASTMD-2863	✓	250°C (Min.)	✓	250°C (Min.)	✓	250°C (Min.)
Smoke Density Rating	ASTMD-2843 IEC: 61034			✓	60% (Max.)	✓	20% (Max.)
Halogen Acid Gas Generation	IEC: 60754-1 EN-50267-2-1			✓	20% (Max.)	✓	0.5% (Max.)
Toxicity Index	IEC: 60754-2 EN-50267-2-2					✓	0.5% (Max.)
Corrosive Gases	IEC: 60754-2 EN-50267-2-2					✓	PH≥4.3 Conductivity ≤100 us/cm
Flame Test on Single Cable	IEC: 60332-1 EN-50265-1	✓	As per Specification	✓	As per Specification	✓	As per Specification
Fire Test on Bunched Cable	IEC: 60332-3 EN-50266-2	✓	As per Specification	✓	As per Specification	✓	As per Specification
Applicable Symbols							



FLAME RETARDANT - IEC 60332-1



FLAME RETARDANT - IEC 60332-3



LOW EMISSION OF DARK FUMES - ASTM D-2843



HALOGEN FREE - IEC 60754-1



LOW TOXICITY AND CORROSIVITY OF EMITTED GASES- IEC 60754-2

Traid & Quad Cables for Resistance Temperature Detector (RTD)

The electrical resistance of metal changes with temperature. This property is used for temperature measurements in industry. Of all usable metals platinum has found the most acceptance as:

- It can be highly refined.
- It resists contamination
- It is mechanically and electrically stable over a large range of temp.
- The relationship between temp. and resistance is quite linear.
- Drift and error with age and use are negligible

Due to its higher electrical output, Platinum Resistance Temp. Detector (RTD) furnishes an accurate input to temp. indicators, controllers, recorders, scanners, data-loggers and computers. It is used for Temp. measurement in the range -220 to 600 C. The max. temp. is determined by the type of insulation material used to enclose the platinum winding.

The most commonly used RTD is PT-100. The sensing element is made of platinum wire and its resistance is 100Ω at 0°C .

Generally the resistance of the RTD forms an arm of the bridge circuit to measure the temperature as under.

Connection Diagram for 2 wire RTD

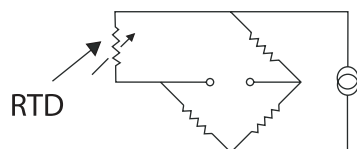

This configuration is used where the distance between the RTD and the measuring instrument is small and high accuracy is not required. Here a pair (2 core) cable is used for connection.

In a process plant there may be quite a distance between the RTD and its indicator. The resistances of lead wires and the change in them due to change in surrounding temp. may add to an error in the measurement.

To take care of lead wire resistance and the change therein due to change in ambient temperature, three wire RTD is used and the connection of the same in the bridge circuit is as under.

Connection Diagram for 3 wire RTD

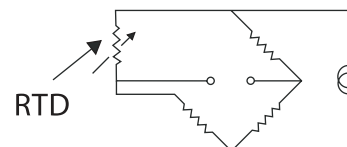

This is the most commonly used and in this case a triad (Three Cores) cable is used for connecting RTD to the indicator/controller/recorder.

For very accurate reading either of the following circuits are used where a quad (Four Core) cable is used connecting RTD to the measuring instrument.

Connection Diagram for 4 wire RTD

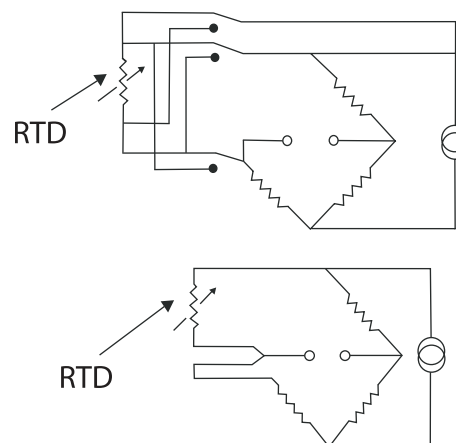

COLOUR CODE FOR INSULATION:

We provide colour code of Red, Yellow, Blue with number printing for core identification in triad cable. Some client ask for Red, Yellow, Yellow or Red, Red, Yellow for identification. B.S. specification also does not specify any colour code for triad.



Our QMS certification by BASEC covers all aspects of our operations and demonstrates our intention to take all the reasonable precautions and exercise due diligence in the continuous process monitoring of our production.

QMS certification by BASEC also enhances customers confidence that the products have been produced under an validated system which has been verified by an competent 3rd Party Agency

3rd Party Approvals

Our Cables are Type Tested and Accepted for Quality by the following 3rd Party Inspecting Agencies :



SPECIAL APPLICATIONS



In Power, Marine, Oil, Gas & Petrochemical Industries a large variety of instrumentation cables are installed due to quantity of signals to be transmitted & various control systems employed in different working environments.

This catalog can give details of some common types of cables. We can offer to our customers a lot of solutions rather than cables restricted to few specifications.

Instrumentation cables may appear to be very similar, but with different performances they can make a big difference in functioning. POLYCAB is a leading manufacturer of a comprehensive range of tailor made cables and we can offer the right Instrumentation & Control cables you are looking for.

FIELDBUS/PROFIBUS CABLE



The requirement of this cables is growing at an astonishing pace and very soon POLYCAB will be in a position to offer this cables to our customers as an additional choice in our wide range of product.

CABLES FOR HARSH ENVIRONMENTAL CONDITIONS



Polycab can offer for Oil, Gas & Petrochemical industry cables with:

- Lead/Polymide sheath cables
- Resistance to heavy vibration,
- Resistance to Hydrocarbon
- Long delivery lengths to reduce number of joints
- Corrosion free screen area
- Different options for outer PE jackets (LDPE, MDPE, HDPE)
- Different options for LSF, LSOH & FRPVC, being anti-termite or UV resistant as per BS 7835 & IEC 60332 etc. and cables to other international standards to meet the very severe Oil, Water, Chemicals, Mechanical Stress in installation conditions.

Handling, Storage and Laying of Cables

Great care is taken in the manufacturing of cables to ensure quality at every stage.

- Handling is the next important factor to ensure that by poor workmanship and mishandling the quality does not deteriorate.
- Of course laying is generally carried out by unskilled or semi-skilled men, strict supervision should be maintained so that this material, which can be very easily damaged, is handled with great care.
- If great care during installation is observed in the handling of cables on site the life of the cables is extended.

A. CABLE INSPECTION

Inspect every cable reel for damage before accepting the shipment. Be particularly alert for cable damage if:

1. A reel is lying flat on its side
2. Several reels are stacked one over the other
3. Other freight is stacked on a reel

4. Cable drums are without planks or broken
5. Nails have been driven into reel flanges to secure shipping blocks
6. A reel flange is damaged
7. A cable covering is removed, stained or damaged
8. A cable end seal is removed or damaged. A reel has been dropped (hidden damage likely)

B. CABLE HANDLING & STORAGE

Damage to cables can occur due to the incorrect handling to which the drums and cables may be subjected; causing breakdown of the drum flanges and in exceptional cases, movement of the drum barrel takes place. Once this breakdown of the drum occurs, the cable is immediately exposed to damage. Cables damaged during handling & storage can cause service failures when the subject cable is put to use.

Thus the following is a list of Do's and Don'ts that should be followed while handling and storing the cables before it is put to use.

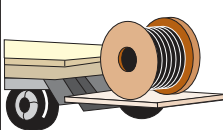
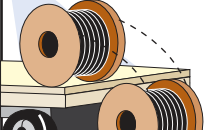
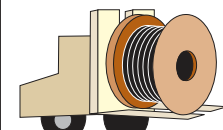
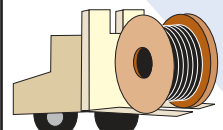
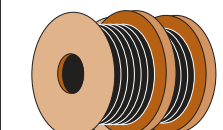
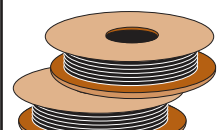
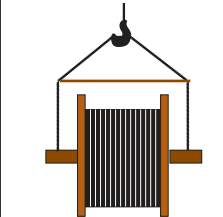
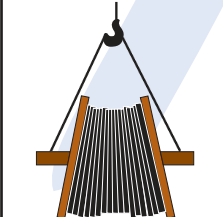
Do's		Don'ts	
	When off loading reels from a truck, lower reels carefully using a hydraulic gate, hoist or forklift truck.		Never drop reels. If reels must be rolled, roll in opposite direction of the cable wraps to keep cable from loosening on the reel.
	If a fork lift is used, approach the reel from the flange side. Position the forks such that the reel is lifted by both reel flanges. Also Consideration should be given to, Traffic patterns during off-loading & damage during the time in storage.		Do not allow the lift forks to contact the cable. Care must be taken by the fork lift operator not to make sudden turns or stops.
	Cable reels should be stored on hard surfaces resting on the flanges edge (flanges vertical). Align reels flange to flange and, if possible, arrange so that first in is first out.		Multiple reels stacked on top of each other ("Pancake" storage) is not recommended for cable drums. The weight of the stack can total thousands of Kgs. creating an enormous load on the bottom reel. Also, damage to the reel and/or cable will likely occur when the reel is flipped for transit. A concentration of stress on the reel flange may cause it to break and subsequently damage the cable.
	When using a hoist, install a mandrel through the reel arbor holes and attach a sling. Use a spreader bar approximately 6 inches longer than the overall reel width placed between the sling ends just above the reel flanges.		This may lead to the bending of the reel flanges and mashing the cable.

Handling, Storage and Laying of Cables

C. PRE- INSTALLATION

To ensure safety during cable installation, following shall be checked prior to installation.

1. The cable selected is proper for designed application.
2. The cable has not been damaged in transit or storage.

Review all applicable state and national codes to verify that the cable chosen is appropriate for the job. Also consult your local electricity authority. Next, you must identify any existing cable damage and prevent any further damaged from occurring. This is done through proper cable inspection, handling and storage.

D. INSTALLATION & LAYING

Mechanical stresses during installation are generally more severe than those encountered while in service. Thus care should be taken as regards to the following while installation and laying of cables.

1. Polycab recommend the laying and installation of cables as per IS: 1255/84.
2. Care shall be taken during laying to avoid sharp bending, and twisting.
3. Cable shall be unwound from the drum by lifting the drum on the center.
4. Shaft supported both ends with suitable jacks / stands.
5. Under no circumstances the cable winding shall be lifted off a coil or drum lying flat at the flanges. This would cause serious twist and damages.
6. Suitable protection shall be provided to the cables against mechanical damages, it includes covers, pipes etc.

E. RECOMMENDED MINIMUM BENDING RADIUS FOR LV CABLES

Single Core : $15 \times D$

Multicore : $12 \times D$

Where D= Diameter of cable in mm

DO NOT ATTEMPT "COILING" OF CABLE ON THE GROUND

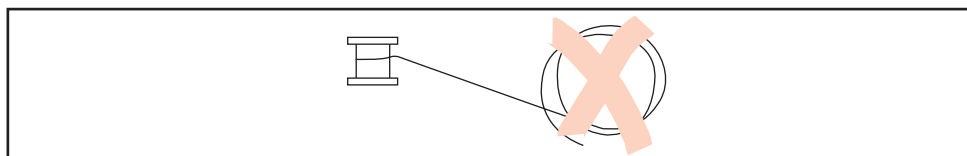

ON THE GROUND CABLE CAN BE FLAKED IN A FIGURE OF EIGHT FORMATION

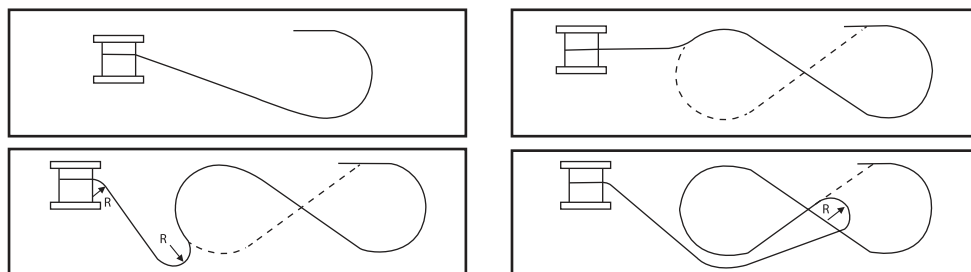

F. RECOMMENDED SAFE PULLING FORCE WITH STOCKINGS:

a) For Unarmoured Cable : $P = 5 D^2$

Where P= Pulling Force

b) For Armoured Cable : $P = 9 D^2$

Where D= Diameter of cable in mm

G. RECOMMENDED SAFE PULLING FORCE WHEN PULLED WITH PULLING EYE :

a) For Aluminum Conductors : 30 N/mm^2

b) For Copper Conductor : 50 N/mm^2

SPECIAL PRECAUTIONS FOR HANDLING / INSTALLATION OF LOW SMOKE SHEATHED CABLES

- Cables like LSF sheath needs to be handled with care during installation. While special additives are used in formulation of LSF compound to give the typical flame retardant characteristics of Zero Halogen Polymers some mechanical properties deteriorate. The following basic precautions are necessary.
- Cables should not be exposed to sunlight for considerable period before installation i.e. the temp of cables sheath should be below 45°C .
- Preferably installation is done during morning hours when the ambient temperature is low.
- Wire/ropes should not be used directly on the cable sheath for pulling.
- When pulled on cable trays/or any uneven surface, special attentions is needed to welding or unusually rough terrains.
- Rollers and bends should not have any sharpness which may damage sheath.

Details Preferred with Enquiry

SERVICE VOLTAGE U₀ /U	<input type="checkbox"/> 300/300 V	<input type="checkbox"/> 300/500 V	<input type="checkbox"/> 600/1000 V	<input type="checkbox"/> Other_____V					
MUTUAL CAPACITANCE	<input type="checkbox"/> max _____ nf/km at 1 kHz								
CONDUCTOR	<input type="checkbox"/> 0.5	<input type="checkbox"/> 0.75	<input type="checkbox"/> 1	<input type="checkbox"/> 1.5	<input type="checkbox"/> 2.5	<input type="checkbox"/> Other_____mm ²			
	<input type="checkbox"/> Solid CL 1	<input type="checkbox"/> Stranded CL 2	<input type="checkbox"/> Flexible CL 5	<input type="checkbox"/> Other					
	<input type="checkbox"/> Tinned Copper	<input type="checkbox"/> Bare Copper			<input type="checkbox"/> IS 8130	<input type="checkbox"/> IEC 60228	<input type="checkbox"/> Other		
INSULATION MATERIAL	<input type="checkbox"/> PVC 'A' Y	<input type="checkbox"/> PVC 'C' Y	<input type="checkbox"/> PE 2Y	<input type="checkbox"/> XLPE 2X	<input type="checkbox"/> FR XLPE 2X	<input type="checkbox"/> O. HAL H	<input type="checkbox"/> CROSSL.O.HAL HX	<input type="checkbox"/> EPR R	<input type="checkbox"/> SILICON 2G(Bi)
STRANDING ELEMENTS	<input type="checkbox"/> Cores	<input type="checkbox"/> Pairs	<input type="checkbox"/> Triples	<input type="checkbox"/> Quads					
INDIVIDUAL SCREENING	<input type="checkbox"/> Aluminium Mylar	<input type="checkbox"/> Copper Mylar	<input type="checkbox"/> Copper Tape	<input type="checkbox"/> Tinned Cu Braiding	<input type="checkbox"/> Bare Cu Braiding	<input type="checkbox"/> Gi Wire Braiding	<input type="checkbox"/> Other	<input type="checkbox"/> Not Required	
DRAIN WIRE	<input type="checkbox"/> 0.5	<input type="checkbox"/> 0.75	<input type="checkbox"/> 1	<input type="checkbox"/> 1.5	<input type="checkbox"/> 2.5	<input type="checkbox"/> Other_____mm ²			
	<input type="checkbox"/> Solid CL 1	<input type="checkbox"/> Stranded CL 2	<input type="checkbox"/> Flexible CL 5	<input type="checkbox"/> Other					
	<input type="checkbox"/> Tinned	<input type="checkbox"/> Bare			<input type="checkbox"/> IS 8130	<input type="checkbox"/> IEC 60228	<input type="checkbox"/> Other		
OVERALL SCREENING	<input type="checkbox"/> Aluminium Mylar	<input type="checkbox"/> Copper Mylar	<input type="checkbox"/> Copper Tape	<input type="checkbox"/> Tinned Cu Braiding	<input type="checkbox"/> Bare Cu Braiding	<input type="checkbox"/> Gi Wire Braiding	<input type="checkbox"/> Other	<input type="checkbox"/> Not Required	
METALLIC SHEATH	<input type="checkbox"/> Alu-Laminated Sheath (L)	<input type="checkbox"/> Lead Alloy "E" Sheath K							
ARMOURING	<input type="checkbox"/> Galv. Double Steel Tapes B	<input type="checkbox"/> Galv. Round Steel Wires R	<input type="checkbox"/> Galv. Flat Steel Wires FG	<input type="checkbox"/> Galv. Steel Wire Braid Q					
OTHER SHEATH	<input type="checkbox"/> PE 2Y	<input type="checkbox"/> HDPE 2Y	<input type="checkbox"/> PVC Y	<input type="checkbox"/> PVC FR Y (FR)	<input type="checkbox"/> PVC FRLS Y (FRLS)	<input type="checkbox"/> O. HAL H	<input type="checkbox"/> CSP CSM	<input type="checkbox"/> Other	
OUTER SHEATH COLOUR	<input type="checkbox"/> Black	<input type="checkbox"/> Red	<input type="checkbox"/> Blue	<input type="checkbox"/> Orange	<input type="checkbox"/> Grey	<input type="checkbox"/> Other_____			
TELEPHONE (COMMUNICATION) PAIR	<input type="checkbox"/> Required <input type="checkbox"/> Not Required								
BEHAVIOUR WHEN AFFECTED BY FIRE	<input type="checkbox"/> Fire Resistant IEC 331			<input type="checkbox"/> Fire Retardant IEC 332-3 Cat_____		<input type="checkbox"/> Flame Retardant IEC 332-1			

In case of thermo couple extension cable and compensating cable please specify type of thermo couple and conductor size required.
 In case of type k thermo couple please inform Conductor Material - Chromel / Alumel or Copper / Constantan etc.
 Specify the standard drum lengths.



Let's go green 

www.polycab.com

Corporate Office:

POLY CAB INDIA LIMITED (formerly known as 'Polycab Wires Limited.')

Polycab House, 771, Mogul Lane, Mahim (W), Mumbai - 400 016, Maharashtra (India)

Ph.: +91-22-2432 7070/4, 6735 1400, Email: enquiry@polycab.com, Toll Free No.: 1800 267 0008, www.polycab.com