

Bringing Light
to Life

PRICE LIST
W.E.F. 1st JULY 2022

**We are a lighting solutions company.
While at the same time, we are more than that.**

Like everything in nature is constantly evolving, we as a Lights manufacturing company too are evolving incessantly.

With over a decade of experience alongside the extremely creative and dynamic teams both internally and externally, we have now developed a clear understanding of what it means to provide lighting solutions.

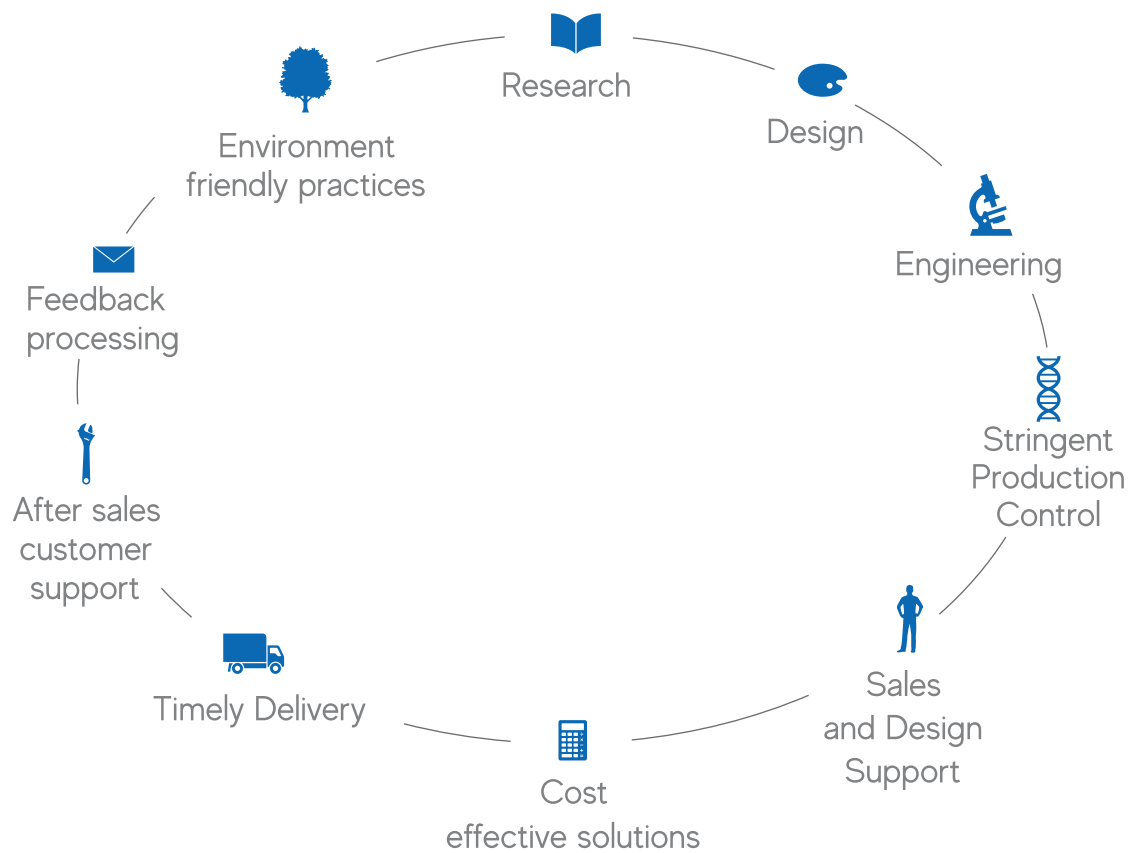

Our focus is to provide a large range of standard and custom-made solutions to meet the need of distinctive projects.

If it has been designed or even imagined, we aim to create the solutions and ensure it has served the space in the best way possible.

Simply put, we are just not a catalogue of products, we are your extended team striving to achieve perfection in every project.

Made In India

R&D Setup

Our Research & Development laboratory comprises various types of testing equipment. These help us keep up with the latest industry standards in the field of lighting. Our lab also caters to harnessing newer technologies in manufacturing, thus helping us achieve maximum efficiency, top-notch quality to leave a minimal carbon footprint.

Testing Equipments

- Power Analyzers
- Humidity chamber
- Thermal imager
- LCR meter
- Goniophotometer
- Integrated Sphere
- Digital Oscilloscope
- Reliability Safety Tests Equipments

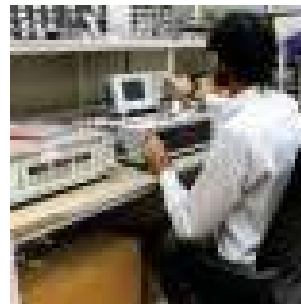

Manufacturing Setup

Our team comprises of skilled employees with strong product validation and QC standard's experience & knowledge to produce quality products. With updated machinery and equipments, it has eased achieving manufacturing efficiency. We are capable of executing supplies of projects of any scale with current available bandwidth and setup.

- 25000 sq. ft. of built up manufacturing facility
- Line and Ageing test to improve product performance
- Updated machinery
- In-house driver design & development setup
- SMT machine for in house LED mounting
- Tool designing Team for OEM working





Brighten up spaces

Our solutions have lit up offices, industrial and commercial spaces, outdoors and consumer areas. We are constantly looking at ways to improve the end users' quality of life, and not just meet, but exceed our customers' expectations.

Our products:

Prismatic Range	—————	7-10
Recessed Downlights	—————	11-18
Surface & Suspended Downlight	—————	19-23
Consumer Luminaires	—————	24-25
Recessed Luminaires	—————	28-29
Surface & Suspended Luminaires	—————	30
Architectural Luminaires	—————	31-36
Industrial & Outdoor Luminaires	—————	39-50
Decorative Luminaires	—————	52

Legero Prismatic Range

Ribbon Prism



This contemporary aerial luminaire is a masterpiece that will add a swanky ambiance to your space. The LED fixture features excellent glare-free light distribution with prismatic diffuser and lightweight extruded aluminium housing for an easy installation. Its sleek design and functionality blend in an incredibly eye-catching ribbon-like shape, making a dapper statement while saving you up to 80% on energy costs.

Product ID	Watt	CCT	Dimension (mm) l b h	MRP
LSR 1020P	20	3000K/4000K/6000K	1000 70 60	12500
LSR 1030P	30	3000K/4000K/6000K	1000 70 60	14500

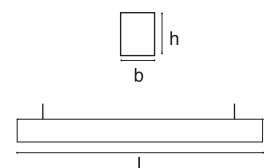

Available Colors

Techpro Prism Direct



Backlit linear light, housing made in Extruded Aluminium with high efficiency prismatic diffuser to reduce the product glare rating. UGR : < 19. Suitable for Armstrong Techzone ceiling.

Product ID	Watt	CCT	Dimension (mm) l b h	MRP
LTL 1030PR	30	3000K/4000K/6000K	1195 145 65	9800

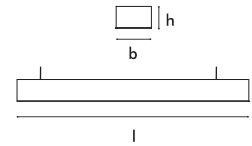

Available Colors

Techpro Prism Up & Down



Backlit linear light, housing made in Extruded Aluminium with high efficiency prismatic diffuser to reduce the product glare rating. UGR : < 19. Suitable for Armstrong Techzone ceiling. Upward/Downward ratio - 20:80.

Product ID	Watt	CCT	Dimension (mm) l b h	MRP
LTL 2035PR	35	3000K/4000K/6000K	1195 145 65	10250

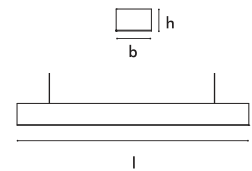

Available Colors

Strapline Prism 50 Up & Down



Direct - Indirect Linear light with Extruded Aluminium body and snapfit high efficiency prismatic diffuser to reduce the glare. UGR : < 19. Suitable for high productive office application. Upward/Downward ratio - 20:80.

Product ID	Watt	CCT	Dimension (mm) l b h	MRP
LSL-S 5130PR	30	3000K/4000K/6000K	1000/1200 52.8 101	9900
LSL-S 5140PR	40	3000K/4000K/6000K	1000/1200 52.8 101	10500

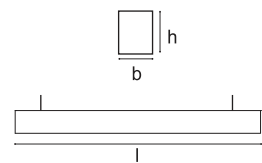

Available Colors

Strapline Prism 50 Suspended



Linear light with Extruded Aluminium body and snapfit high efficiency prismatic diffuser to reduce the glare. UGR : < 19. Suitable for high productive office application.

Product ID	Watt	CCT	Dimension (mm) l b h	MRP
LSL-S 5020PR	20	3000K/4000K/6000K	1000/1200 63 80	6850/7050
LSL-S 5030PR	30	3000K/4000K/6000K	1000/1200 63 80	7050/7250

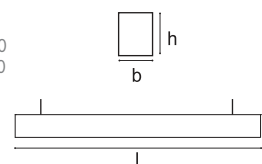

Available Colors

Strapline Prism 50 Recessed



IP20

Linear light with Extruded Aluminium body and snapfit high efficiency prismatic diffuser to reduce the glare. UGR : < 19. Suitable for high productive office application.

Product ID	Watt	CCT	Cutout (mm) l x b	Dimension (mm) l b h	MRP
LSL-R 5020PR	20	3000K/4000K/6000K	992/1192 55	1000/1200 63 80	6850/7050
LSL-R 5030PR	30	3000K/4000K/6000K	992/1192 55	1000/1200 63 80	7050/7250

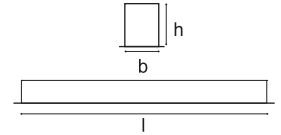

Available Colors

Pill Prism Suspended



IP20

Round extruded aluminium housing with Prismatic diffuser. High efficient LEDs for uniform light distribution with UGR : < 19.

Product ID	Watt	CCT	Dimension (mm) ø h	MRP
ALP-S 4130PR	30	3000K/4000K/6000K	400 60	12500
ALP-S 5145PR	45	3000K/4000K/6000K	500 60	17500
ALP-S 6156PR	56	3000K/4000K/6000K	600 60	21500
ALP-S 9180PR	80	3000K/4000K/6000K	900 60	42000
ALP-S 12100PR	100	3000K/4000K/6000K	1170 60	55800

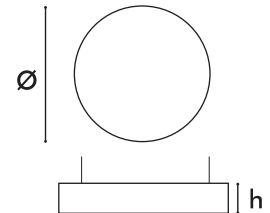

Available Colors

Ripple Prism

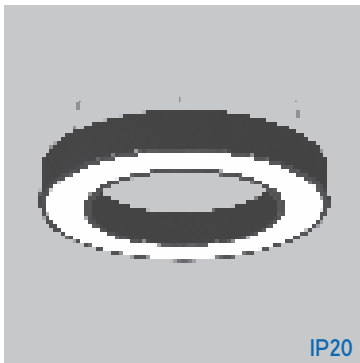

IP20

Round extruded aluminium housing with diffuser. Smart circular ring gives functional decorative look. Also diffuser is so fixed to provide uniform light output.

Product ID	Watt	CCT	Dimension (mm) ø h	MRP
ARL 6030PR	30	3000K/4000K/6000K	600 60	24000
ARL 9055PR	55	3000K/4000K/6000K	900 60	42000
ARL 12080PR	80	3000K/4000K/6000K	1170 60	61500
ARL 15000PR		3000K/4000K/6000K	1500 60	
ARL 18000PR	As per Request	3000K/4000K/6000K	1800 60	On Request
ARL 20000PR		3000K/4000K/6000K	2000 60	
ARL 24000PR		3000K/4000K/6000K	2400 60	

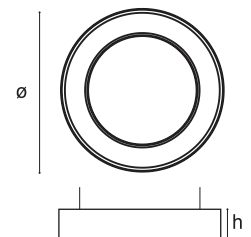

Available Colors

Modena Prism



IP20

Recessed Grid Ceiling Luminaire with high efficiency prismatic diffuser to reduce the product glare rating. Suitable for high productive office application. UGR : < 19

Product ID	Watt	CCT	Cutout (mm) l x b	Dimension (mm) l b h	MRP
LER 2628PR	28	3000K/4000K/6000K	575 x 575	595 595 76	4500
LER 2636PR	36	3000K/4000K/6000K	575 x 575	595 595 76	4600
LER 2640PR	40	3000K/4000K/6000K	575 x 575	595 595 76	4800

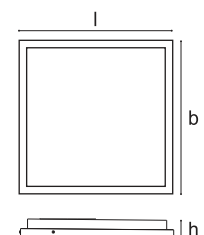

Available Colors

Modena Prism 1x4



IP20

1X4 Recessed Grid Ceiling Luminaire with high efficiency prismatic diffuser to reduce the product glare rating. Suitable for high productive office application. UGR : < 19

Product ID	Watt	CCT	Cutout (mm) l x b	Dimension (mm) l b h	MRP
LER 1240PR	40	3000K/4000K/6000K	1175 x 275	1195 295 80	6200

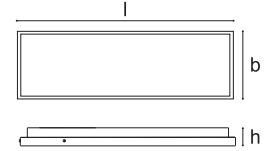

Available Colors

Atmos Prism



IP20

Sleek round backlit LED downlight made up of die-cast housing & light weight plastic trim which is designed as a reflector to give high lumen efficacy. Also Prismatic diffuser is fixed in inner periphery of trim to cut down the glare & provide uniform light output.

Product ID	Watt	CCT	Cutout (mm) ø	Dimension (mm) ø h	MRP
LAT 009PR	9	3000K/4000K/6000K	110	126 40	1100
LAT 013PR	13	3000K/4000K/6000K	110	126 40	1200
LAT 016PR	16	3000K/4000K/6000K	140	160 40	1450
LAT 018PR	18	3000K/4000K/6000K	140	160 40	1500

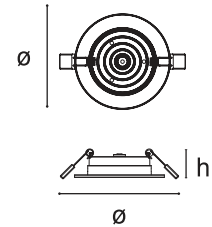

Available Colors

Pearl Prism (R)



IP20

Sleek round backlit LED downlight made up of die-cast housing & light weight plastic trim designed for better aesthetics with high efficacy LEDs and prismatic diffuser to give glare free output.

Product ID	Watt	CCT	Cutout (mm) ø	Dimension (mm) ø h	MRP
LRS 2005PR	5	3000K/4000K/6000K	79	108 30	950
LRS 2012PR	12	3000K/4000K/6000K	105	130 30	1150
LRS 2015PR	15	3000K/4000K/6000K	138	160 30	1250
LRS 2018PR	18	3000K/4000K/6000K	138	160 30	1350

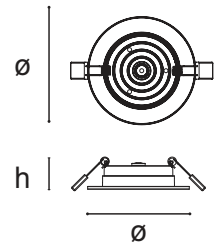

Available Colors

Pearl Prism (Sq)



IP20

Sleek square backlit LED downlight made up of die-cast aluminium housing & light weight plastic trim designed for better aesthetics with high efficacy LEDs and Prismatic diffuser to give glare free output.

Product ID	Watt	CCT	Cutout (mm) l x b	Dimension (mm) l b h	MRP
LRS 3005PR	5	3000K/4000K/6000K	79 x 79	108 108 30	950
LRS 3012PR	12	3000K/4000K/6000K	105 x 105	130 130 30	1150
LRS 3015PR	15	3000K/4000K/6000K	138 x 138	160 160 30	1250
LRS 3018PR	18	3000K/4000K/6000K	138 x 138	160 160 30	1350

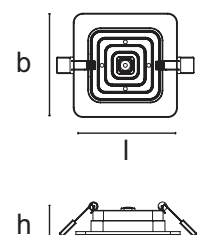

Available Colors

Omega



IP20

A versatile collection of energy efficient round LED downlight for general lighting in various applications. These recessed diffused round LED downlights are made of high efficient die-cast aluminium housing with high transmission factor diffuser.

Product ID	Watt	CCT	Cutout (mm) \varnothing	Dimension (mm) \varnothing h	MRP
LVT 6507	7	3000K/4000K/6000K	102	112 53	740
LVT 6509	9	3000K/4000K/6000K	134	145 53	1100
LVT 6512	12	3000K/4000K/6000K	134	145 53	1200
LVT 6515	15	3000K/4000K/6000K	164	175 60	1350
LVT 6518	18	3000K/4000K/6000K	164	175 60	1500
LVT 6522	22	3000K/4000K/6000K	164	175 60	1900

Available Colors

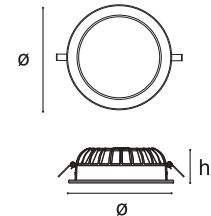

Omega-D



IP20

Compact styling, clean fascias and enclosed precision die-cast adjustable lamp housing with polycarbonate diffuser & energy efficient light sources .

Product ID	Watt	CCT	Cutout (mm) \varnothing	Dimension (mm) \varnothing h	MRP
LHR 6920	20	3000K/4000K/6000K	133	145 88	2970
LHR 6925	25	3000K/4000K/6000K	133	145 88	3100
LHR 6930	30	3000K/4000K/6000K	133	145 88	3370

Available Colors

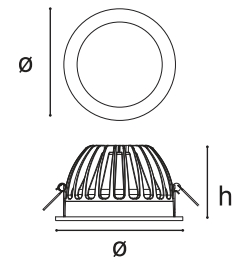

Oculus



IP20

Sleek round backlit LED downlight made up of die-cast housing with ring shape diffuser to give decorative & unique look to the product.

Product ID	Watt	CCT	Cutout (mm) \varnothing	Dimension (mm) \varnothing h	MRP
LOC 015	15	3000K/4000K/6000K	129	135 36	1300
LOC 018	18	3000K/4000K/6000K	129	135 36	1450
LOC 020	20	3000K/4000K/6000K	129	135 36	1650

Available Colors

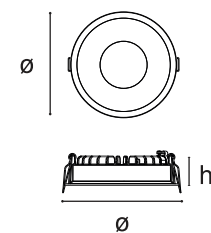

Atmos



IP20

Sleek round backlit LED downlight made up of die-cast housing & light weight plastic trim which is designed as a reflector to give high lumen efficacy. Also opal diffuser is fixed in inner periphery of trim to cut down the glare & provide uniform light output.

Product ID	Watt	CCT	Cutout (mm) \varnothing	Dimension (mm) \varnothing h	MRP
LAT 009	9	3000K/4000K/6000K	110	126 40	795
LAT 013	13	3000K/4000K/6000K	110	126 40	1000
LAT 016	16	3000K/4000K/6000K	140	160 40	1200
LAT 018	18	3000K/4000K/6000K	140	160 40	1500

Available Colors

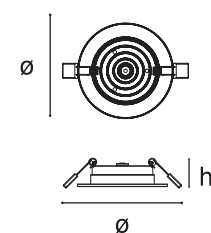

Pearl (R)



IP20

Sleek round backlit LED downlight made up of die-cast housing & light weight plastic trim designed for better aesthetics with high efficacy LEDs and diffuser to give glare free output.

Product ID	Watt	CCT	Cutout (mm) \varnothing	Dimension (mm) \varnothing h	MRP
LRS 2005	5	3000K/4000K/6000K	79	108 30	500
LRS 2012	12	3000K/4000K/6000K	105	130 30	750
LRS 2015	15	3000K/4000K/6000K	138	160 30	960
LRS 2018	18	3000K/4000K/6000K	138	160 30	1050

Available Colors

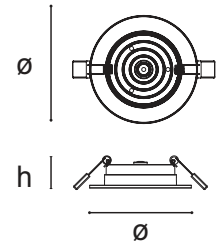

Pearl (Sq)



IP20

Sleek square backlit LED downlight made up of die-cast aluminium housing & light weight plastic trim designed for better aesthetics with high efficacy LEDs and diffuser to give glare free output.

Product ID	Watt	CCT	Cutout (mm) l x b	Dimension (mm) l b h	MRP
LRS 3005	5	3000K/4000K/6000K	79 x 79	108 108 30	500
LRS 3012	12	3000K/4000K/6000K	105 x 105	130 130 30	750
LRS 3015	15	3000K/4000K/6000K	138 x 138	160 160 30	960
LRS 3018	18	3000K/4000K/6000K	138 x 138	160 160 30	1050

Available Colors

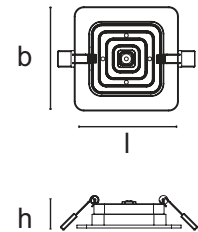

Coral (R)



IP20

Sleek round panel downlight with integrated edge-lit LEDs installed with highly efficient low glare diffuser for optimum light distribution. Housing is made of pressure die-cast aluminium.

Product ID	Watt	CCT	Cutout (mm) \varnothing	Dimension (mm) \varnothing h	MRP
LRS 4006	6	3000K/4000K/6000K	80	95 30	580
LRS 4012	12	3000K/4000K/6000K	142	159 30	750
LRS 4015	15	3000K/4000K/6000K	142	159 30	850
LRS 4018	18	3000K/4000K/6000K	176	196 30	1150
LRS 4022	22	3000K/4000K/6000K	176	196 30	1275

Available Colors

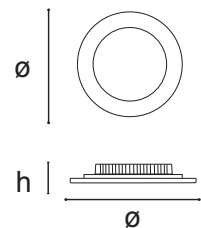

Coral (Sq)



IP20

Sleek square panel downlight with integrated edge-lit LEDs installed with highly efficient low glare diffuser for optimum light distribution. Housing is made of pressure die-cast aluminium.

Product ID	Watt	CCT	Cutout (mm) l x b	Dimension (mm) l b h	MRP
LRS 5006	6	3000K/4000K/6000K	83.5 x 83.5	100 100 30	580
LRS 5012	12	3000K/4000K/6000K	119.5 x 119.5	140 140 30	750
LRS 5015	15	3000K/4000K/6000K	119.5 x 119.5	140 140 30	850
LRS 5018	18	3000K/4000K/6000K	176 x 176	190 190 30	1150
LRS 5022	22	3000K/4000K/6000K	176 x 176	190 190 30	1275

Available Colors

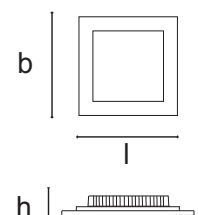

Mist (R)



IP20

Compact & sleek round LED backlit downlight made up of polycarbonate housing, high efficacy LEDs, high grade material diffuser to give uniform & glare free output. Easy to install as the product comes with inbuilt energy efficient control gear.

Product ID	Watt	CCT	Cutout (mm) \varnothing	Dimension (mm) \varnothing h	MRP
LRC-R 2005	5	3000K/4000K/6000K	64	82 35.5	350
LRC-R 2009	9	3000K/4000K/6000K	96	116 36	490
LRC-R 2012	12	3000K/4000K/6000K	125	145 36	625
LRC-R 2015	15	3000K/4000K/6000K	145	166 36	750

Available Colors

LRC-RA 0009 *Mist Surface Round Ring for 9 watt Rs.125
LRC-RA 0015 *Mist Surface Round Ring for 15 watt Rs. 215

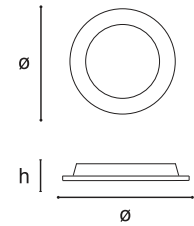

Mist (Sq)



IP20

Compact & sleek square LED backlit downlight made up of Polycarbonate housing, high efficacy LEDs, high grade material diffuser to give uniform & glare free output. Easy to install as the product comes with inbuilt energy efficient control gear.

Product ID	Watt	CCT	Cutout (mm) l x b	Dimension (mm) l b h	MRP
LRC-S 2005	5	3000K/4000K/6000K	63 x 63	82 82 35	350
LRC-S 2009	9	3000K/4000K/6000K	95 x 95	116 116 36	490
LRC-S 2012	12	3000K/4000K/6000K	125 x 125	145 145 36	625
LRC-S 2015	15	3000K/4000K/6000K	146 x 146	166 166 36	750

Available Colors

LRC-SA 0009 *Mist Surface Square Ring for 9 watt Rs.125
LRC-SA 0015 *Mist Surface Square Ring for 15 watt Rs.215

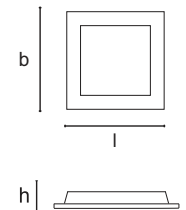

Comet (R)



IP20

Round trimless COB downlight made of die-cast aluminium housing and robust heat sink for excellent thermal management. It consists of high efficiency reflector to produce excellent light output. Available in Rose Gold, Gold, Silver, Gun Metal, White & Black Reflector.

Product ID	Watt	CCT	Beam Angles	Cutout (mm) \varnothing	Dimension (mm) \varnothing h	MRP
LCT 1008	8	3000K/4000K/6000K	50°	88	84 95	2150
LCT 1012	12	3000K/4000K/6000K	50°	88	84 95	2350
LCT 1014	14	3000K/4000K/6000K	50°	88	84 95	2650

Available Colors

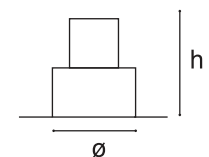

Lego



IP20

Recessed COB downlight made up of die-cast aluminium housing & robust heat sink for excellent thermal management, also it offers a wide choice of option for different color reflectors (Rose Gold, Gold, Silver, Gun Metal, White & Black).

Product ID	Watt	CCT	Beam Angles	Cutout (mm) \varnothing	Dimension (mm) \varnothing h	MRP
LRS 8908	8	3000K/4000K/6000K	50°	80	86.2 90	1050
LRS 8912	12	3000K/4000K/6000K	50°	80	86.2 90	1250
LRS 8914	14	3000K/4000K/6000K	50°	80	86.2 90	1450

Available Colors

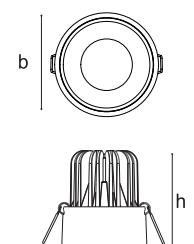

Sol



IP20

Recessed COB down light made of die cast aluminum housing and robust heat sink for excellent thermal management. It consists of high efficiency polycarbonate reflector to produce excellent light output.

Product ID	Watt	CCT	Beam Angles	Cutout (mm) \varnothing	Dimension (mm) \varnothing h	MRP
LHR 5608	8	3000K/4000K/6000K	50°	94	105 101	1200
LHR 5612	12	3000K/4000K/6000K	50°	94	105 101	1450
LHR 5614	14	3000K/4000K/6000K	50°	94	105 101	1550

Available Colors

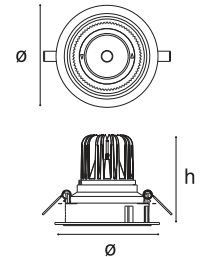

Nova



IP20

Decorative deep COB spot downlight with designer trim and deep recessed reflector to cut glare.

Product ID	Watt	CCT	Beam Angles	Cutout (mm) \varnothing	Dimension (mm) \varnothing h	MRP
LRS 5108	8	3000K/4000K/6000K	50°	93	104.6 96	950
LRS 5112	12	3000K/4000K/6000K	50°	93	104.6 96	1150
LRS 5114	14	3000K/4000K/6000K	50°	93	104.6 96	1325

Available Colors

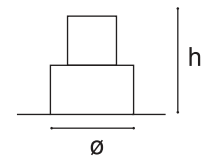

Docco



IP20

Compact styling, clean fascias and enclosed precision die-cast adjustable lamp housing with polycarbonate reflector & energy efficient light sources .

Product ID	Watt	CCT	Beam Angles	Cutout (mm) l x b	Dimension (mm) l b h	MRP
LHR 6108	8	3000K/4000K/6000K	50°	106 x 106	110 110 73	1260
LHR 6112	12	3000K/4000K/6000K	50°	106 x 106	110 110 73	1500
LHR 6114	14	3000K/4000K/6000K	50°	106 x 106	110 110 73	1740

Available Colors

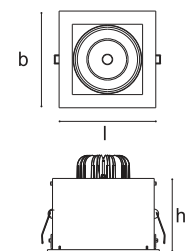

Double Docco



IP20

Twin decorative COB downlight, compact styling, clean fascias and enclosed precision die-cast adjustable lamp housing with polycarbonate reflector & energy efficient light sources .

Product ID	Watt	CCT	Beam Angles	Cutout (mm) l x b	Dimension (mm) l b h	MRP
LHR 6216	16	3000K/4000K/6000K	50°	185 x 106	205 110 73	2650
LHR 6224	24	3000K/4000K/6000K	50°	185 x 106	205 110 73	2975
LHR 6228	28	3000K/4000K/6000K	50°	185 x 106	205 110 73	3420

Available Colors

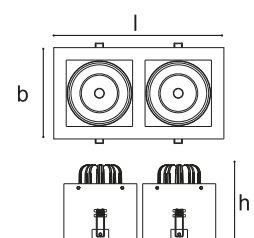

Triple Docco

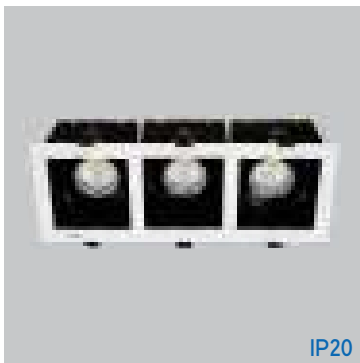

IP20

Triple decorative COB downlight, compact styling, clean fascias and enclosed precision die-cast adjustable lamp housing with polycarbonate reflector & energy efficient light sources .

Product ID	Watt	CCT	Beam Angles	Cutout (mm) l x b	Dimension (mm) l b h	MRP
LHR 6324	24	3000K/4000K/6000K	50°	280 x 106	298 110 73	3925
LHR 6336	36	3000K/4000K/6000K	50°	280 x 106	298 110 73	4680
LHR 6342	42	3000K/4000K/6000K	50°	280 x 106	298 110 73	5340

Available Colors

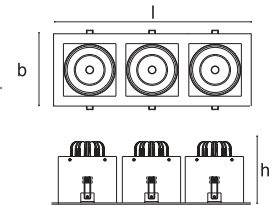

Mika



IP20

High efficient square COB recess downlight encompassing of die-cast aluminium trim and deep recess reflector to cut glare & Suitable for multiple applications. Best optical and thermal solution for high performance.

Product ID	Watt	CCT	Beam Angles	Cutout (mm) l x b	Dimension (mm) l b h	MRP
LRS 9008	8	3000K/4000K/6000K	50°	79 x 94	100 100 87	950
LRS 9012	12	3000K/4000K/6000K	50°	79 x 94	100 100 87	1175
LRS 9014	14	3000K/4000K/6000K	50°	79 x 94	100 100 87	1350

Available Colors

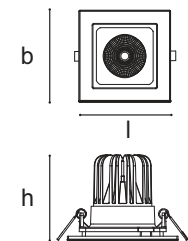

Vela



IP20

The COB wallwasher with softly contoured polycarbonate reflector & energy efficient light source that combines to produce luminaire of exceptional performance.

Product ID	Watt	CCT	Beam Angles	Cutout (mm) ø	Dimension (mm) ø h	MRP
LHR 6508	8	3000K/4000K/6000K	50°	88	96 96	1075
LHR 6512	12	3000K/4000K/6000K	50°	88	96 96	1500
LHR 6514	14	3000K/4000K/6000K	50°	88	96 96	1575

Available Colors

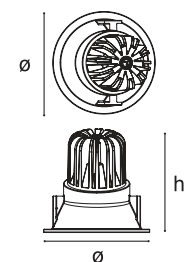

Opal

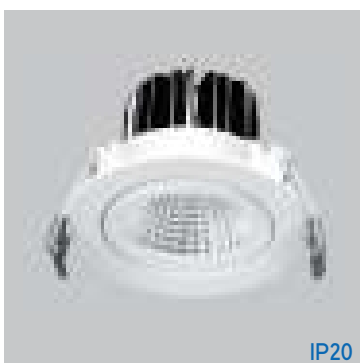

IP20

Recess adjustable COB downlight made of die-cast aluminium housing and robust heat sink for excellent thermal management. It consists of high efficiency reflector to produce excellent light output.

Product ID	Watt	CCT	Beam Angles	Cutout (mm) ø	Dimension (mm) ø h	MRP
LRS 6008	8	3000K/4000K/6000K	50°	75	88 67	875
LRS 6012	12	3000K/4000K/6000K	50°	75	88 67	1050
LRS 6014	14	3000K/4000K/6000K	50°	75	88 67	1150
LRS 6020	20	3000K/4000K/6000K	40°	106	120 78	1800
LRS 6025	25	3000K/4000K/6000K	50°	140	159 95	2100
LRS 6030	30	3000K/4000K/6000K	50°	140	159 95	2500
LRS 6035	35	3000K/4000K/6000K	50°	140	159 95	2700

Available Colors

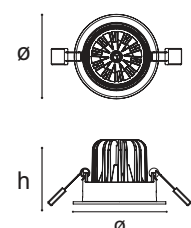

Avio



IP20

The COB spot light with softly contoured reflector and energy efficient light source that combines to produce a luminaire of exceptional style and performance.

Product ID	Watt	CCT	Beam Angles	Cutout (mm) \varnothing	Dimension (mm) \varnothing h	MRP
LRS 7008	8	3000K/4000K/6000K	50°	70	82 79	895
LRS 7012	12	3000K/4000K/6000K	50°	70	82 79	1100
LRS 7014	14	3000K/4000K/6000K	50°	70	82 79	1250
LRS 7018	18	3000K/4000K/6000K	40°	117	125 95	1725
LRS 7022	22	3000K/4000K/6000K	40°	117	125 95	1890

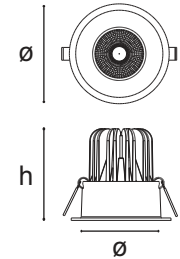

Available Colors

Omega-R



IP20

Recessed COB downlights made of high efficiency die-cast aluminium with powder coated finish. Available with comprehensive choice of color temperatures and wattages.

Product ID	Watt	CCT	Beam Angles	Cutout (mm) \varnothing	Dimension (mm) \varnothing h	MRP
LHR 6720	20	3000K/4000K/6000K	50°	133	145 88	2500
LHR 6725	25	3000K/4000K/6000K	50°	133	145 88	2700
LHR 6730	30	3000K/4000K/6000K	50°	133	145 88	2900

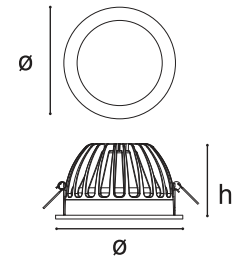

Available Colors

Sigma



IP20

The design features include fully enclosed precision die-cast aluminium construction, excellent pan and tilt adjustment. These adjustable recessed single chip COB downlights consist of high purity aluminium reflector.

Product ID	Watt	CCT	Beam Angles	Cutout (mm) \varnothing	Dimension (mm) \varnothing h	MRP
LHR 6815	15	3000K/4000K/6000K	24°	102	114 98	2540
LHR 6825	25	3000K/4000K/6000K	35°	129	137 121	3820
LHR 6835	35	3000K/4000K/6000K	40°	154	163.5 148	4480
LHR 6845	45	3000K/4000K/6000K	40°	174	190.5 167	6720

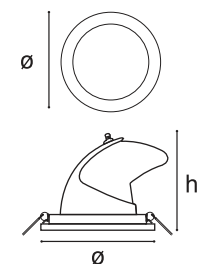

Available Colors

Gia



Small Recessed COB Round downlight made of die-cast aluminium with powder coating finish. Excellent heat sink capacity to minimize luminous degradation.

Product ID	Watt	CCT	Beam Angles	Cutout (mm) \varnothing	Dimension (mm) \varnothing h	MRP
LRS 8007 (Black Reflector)	7	3000K/4000K/6000K	36°	61	68 66	910
LRS 8007 (White Reflector)	7	3000K/4000K/6000K	36°	61	68 66	910
LRS 8007 (Copper Reflector)	7	3000K/4000K/6000K	36°	61	68 66	950
LRS 8007 (Silver Anodized Reflector)	7	3000K/4000K/6000K	36°	61	68 66	950

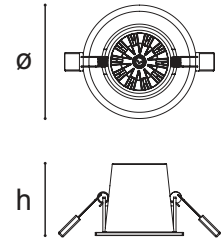

Available Colors ●

Mia



Small Recessed COB square downlight made of die-cast aluminium with powder coating finish. Excellent heat sink capacity to minimize luminous degradation.

Product ID	Watt	CCT	Beam Angles	Cutout (mm) l x b	Dimension (mm) l b h	MRP
LRS 8107 (Black Reflector)	7	3000K/4000K/6000K	36°	61 x 61	70 70 63	910
LRS 8107 (White Reflector)	7	3000K/4000K/6000K	36°	61 x 61	70 70 63	910
LRS 8107 (Copper Reflector)	7	3000K/4000K/6000K	36°	61 x 61	70 70 63	950
LRS 8107 (Silver Anodized Reflector)	7	3000K/4000K/6000K	36°	61 x 61	70 70 63	950

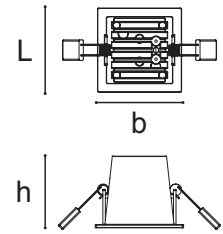

Available Colors ●

Cribo



Small adjustable recessed downlight with die-cast aluminium body & reflector with 15 degree tilt option, excellent heat sink capability to minimize luminous degradation.

Product ID	Watt	CCT	Beam Angles	Cutout (mm) \varnothing	Dimension (mm) \varnothing h	MRP
LRS 1205	5	3000K/4000K/6000K	40°	60	66 42	650

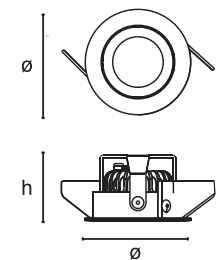

Available Colors ○

Ziva



Recessed small COB downlight in circular shape made of die-cast aluminium housing and has robust heat sink for excellent thermal management. It consist of high efficiency reflector to produce excellent light output.

Product ID	Watt	CCT	Beam Angles	Cutout (mm) \varnothing	Dimension (mm) \varnothing h	MRP
LRS 1305	5	3000K/4000K/6000K	40°	52.5	57 38.5	525

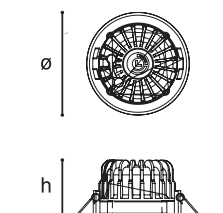

Available Colors ○

Button



The spotlight combines a sharp design with energy efficient LED module. The high quality lens further enhances the quality of the product which is housed within a die-cast aluminium body.

Product ID	Watt	CCT	Beam Angles	Cutout (mm) \varnothing	Dimension (mm) \varnothing h	MRP
LRS 1002	2	3000K/6000K	20°	29	38 28	300

Available Colors

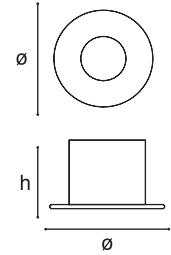

Cell



The spotlight combines a sharp design with energy efficient COB module. It consists of high efficiency chrome plated PC reflector to produce excellent light output which is housed within a die-cast aluminium body.

Product ID	Watt	CCT	Beam Angles	Cutout (mm) \varnothing	Dimension (mm) \varnothing h	MRP
LRS 1403	3	3000K/4000K/6000K	65°	28	38 28	300

Available Colors

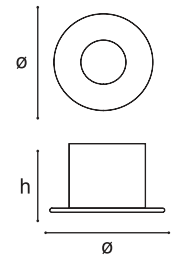

Coral Surface (R)



Surface mount round edge-lit downlight with high efficacy LEDs with highly efficient and low glare diffuser for optimum light distribution.

Product ID	Watt	CCT	Dimension (mm) ø h	MRP
LRS 3106	6	3000K/4000K/6000K	98 43	550
LRS 3112	12	3000K/4000K/6000K	160 43	850
LRS 3115	15	3000K/4000K/6000K	160 43	950
LRS 3118	18	3000K/4000K/6000K	202 48.5	1300
LRS 3122	22	3000K/4000K/6000K	202 48.5	1550

Available Colors ●

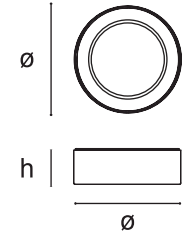

Coral Surface (Sq)



Surface mount square edge-lit downlight with high efficacy LEDs with highly efficient and low glare diffuser for optimum light distribution.

Product ID	Watt	CCT	Dimension (mm) l b h	MRP
LRS 4106	6	3000K/4000K/6000K	102 102 34	550
LRS 4112	12	3000K/4000K/6000K	141 141 42	850
LRS 4115	15	3000K/4000K/6000K	141 141 42	950
LRS 4118	18	3000K/4000K/6000K	191.5 191.5 42	1300

Available Colors ●

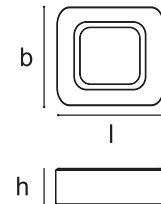

Omega Surface



Surface mount LED downlight. Made of CRCA housing. Specular finished diffuser with high efficient LEDs for better light distribution.

Product ID	Watt	CCT	Dimension (mm) ø h	MRP
LVS 6512	12	3000K/4000K/6000K	149 105	1890
LVS 6515	15	3000K/4000K/6000K	177.5 107	2400
LVS 6518	18	3000K/4000K/6000K	177.5 107	2800

Available Colors ●

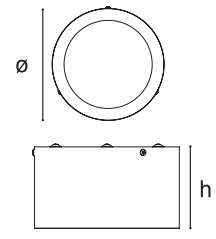

Omega Suspended



Suspended LED downlight. Made of CRCA housing. Specular finished diffuser with high efficient LEDs for better light distribution.

Product ID	Watt	CCT	Dimension (mm) ø h	MRP
LVS 6712	12	3000K/4000K/6000K	149 105	2025
LVS 6715	15	3000K/4000K/6000K	177.5 107	2725
LVS 6718	18	3000K/4000K/6000K	177.5 107	2975

Available Colors ●

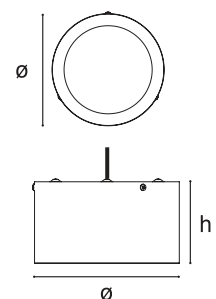

Omega-R Surface



IP20

Surface mount COB downlight with high efficient COB & reflector for better light distribution. Housing made of CRCA.

Product ID	Watt	CCT	Beam Angles	Dimension (mm) ø h	MRP
LVS R 6520	20	3000K/4000K/6000K	50°	148 135	3180

Available Colors ●

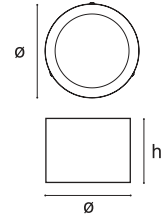

Omega-R Suspended



IP20

Suspended COB downlight with high efficient COB & reflector for better light distribution. Housing made of CRCA.

Product ID	Watt	CCT	Beam Angles	Dimension (mm) ø h	MRP
LVS R 6820	20	3000K/4000K/6000K	50°	148 135	3300

Available Colors ●

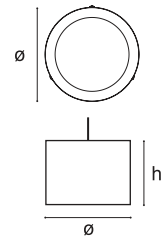

Tubo Surface



IP20

Surface mount cylindrical COB downlight with extruded aluminum housing & die casted heat sink. It has efficient COB & reflector for better light distribution suitable for retail, hospitality & residential application area.

Product ID	Watt	CCT	Beam Angles	Dimension (mm) ø h	MRP
LRS 3308	8	3000K/4000K/6000K	50°	63 185	1925
LRS 3312	12	3000K/4000K/6000K	50°	63 185	2178
LRS 3318	18	3000K/4000K/6000K	36°	88 200	2475

Available Colors ●

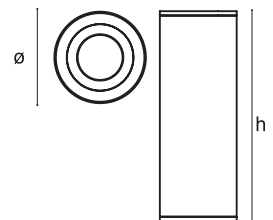

Tubo Suspended



IP20

Suspended cylindrical COB downlight with extruded aluminum housing & die casted heat sink. It has efficient COB & reflector for better light distribution suitable for retail, hospitality & residential application area.

Product ID	Watt	CCT	Beam Angles	Dimension (mm) ø h	MRP
LRS-S 3308	8	3000K/4000K/6000K	50°	63 185	2090
LRS-S 3312	12	3000K/4000K/6000K	50°	63 185	2310
LRS-S 3318	18	3000K/4000K/6000K	36°	88 200	2500

Available Colors ●

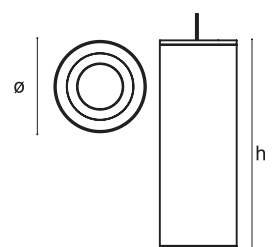

Tubo-D Surface



Surface mounted cylindrical COB downlight with extruded aluminum housing & die casted heat sink. It has Diffused light with efficient COB & reflector for better light distribution suitable for retail, hospitality & residential application area.

Product ID	Watt	CCT	Dimension (mm) ø h	MRP
LRS 3408	8	3000K/4000K/6000K	63 185	1870
LRS 3414	14	3000K/4000K/6000K	63 185	2000
LRS 3418	18	3000K/4000K/6000K	88 200	2800

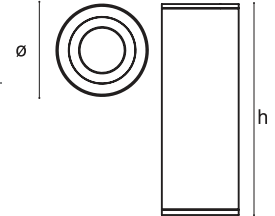

Available Colors

Tubo-D Suspended



Suspended cylindrical COB downlight with extruded aluminum housing & die casted heat sink. It has Diffused light with efficient COB & reflector for better light distribution suitable for retail, hospitality & residential application area.

Product ID	Watt	CCT	Dimension (mm) ø h	MRP
LRS-S 3408	8	3000K/4000K/6000K	63 185	2035
LRS-S 3412	12	3000K/4000K/6000K	63 185	2310
LRS-S 3418	18	3000K/4000K/6000K	88 200	2850

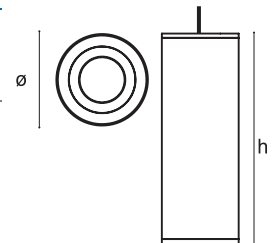

Available Colors

Nora



Surface mounted adjustable COB downlight with high efficient COB and reflector for better light distribution suitable for retail, hospitality and residential application area.

Product ID	Watt	CCT	Beam Angles	Dimension (mm) l b h	MRP
LDN 7110	1x10	3000K/4000K/6000K	50°	99 99 109	1850

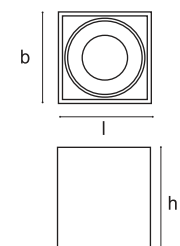

Available Colors

Nora Suspended



Suspended mounted adjustable COB downlight with high efficient COB and reflector for better light distribution suitable for retail, hospitality and residential application area.

Product ID	Watt	CCT	Beam Angles	Dimension (mm) l b h	MRP
LDN 7310	1x10	3000K/4000K/6000K	50°	99 99 109	1950

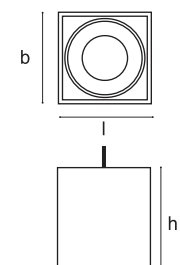

Available Colors

Nora-D



Surface mount twin adjustable COB downlight with high efficient COB and reflector for better light distribution suitable for retail, hospitality and residential application area.

Product ID	Watt	CCT	Beam Angles	Dimension (mm) l b h	MRP
LDN 7220	2x10	3000K/4000K/6000K	50°	186 97 109	3700

Available Colors

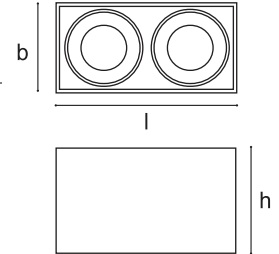

Nora-D Suspended



Suspended mount twin adjustable COB downlight with high efficient COB and reflector for better light distribution suitable for retail, hospitality and residential application area.

Product ID	Watt	CCT	Beam Angles	Dimension (mm) l b h	MRP
LDN 7420	2x10	3000K/4000K/6000K	50°	186 97 109	3900

Available Colors

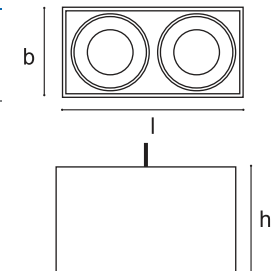

Aura



Organic design with die cast housing & heat sink for efficient heat dissipation. Ideal for retail & hospitality. Curved deep diamond facet reflector with glass to cut glare. Optical and thermal solution for high performance.

Product ID	Watt	CCT	Beam Angles	Dimension (mm) l b h	MRP
LAU 0020	20	3000K/4000K/6000K	36°	191 90 171	2400
LAU 0025	25	3000K/4000K/6000K	36°	191 90 171	2500
LAU 0030	30	3000K/4000K/6000K	36°	191 90 171	2700

Available Colors

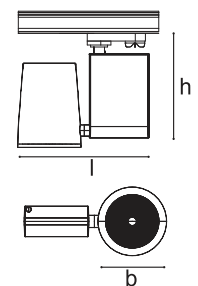

Aura Surface



Surface mounted die-cast housing and heat sink for efficient heat dissipation in surface mounted option. Can be installed directly on ceiling. Curved deep diamond facet reflector with glass to cut glare.

Product ID	Watt	CCT	Beam Angles	Dimension (mm) l b h	MRP
LAU 1020	20	3000K/4000K/6000K	36°	191 90 171	2300
LAU 1025	25	3000K/4000K/6000K	36°	191 90 171	2450
LAU 1030	30	3000K/4000K/6000K	36°	191 90 171	2650

Available Colors

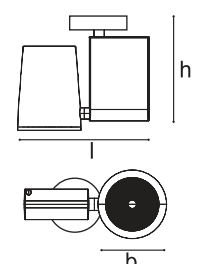

Focus



IP20

Surface mounted cylindrical COB adjustable track light with extruded aluminium housing & die-cast aluminium heat sink. It has efficient COB & reflector for better light distribution.

Product ID	Watt	CCT	Beam Angles	Dimension (mm) ø l h	MRP
LSF 3308	8	3000K/4000K/6000K	36°	63 110 125	1180

Available Colors ●

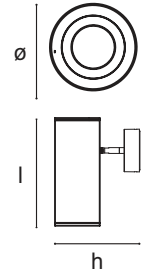

Ace



IP20

Organic design with die cast housing & heat sink for efficient heat dissipation. Ideal for retail & hospitality. Optical lens with adjustable beam angle for better light distribution. Optical and thermal solution for high performance.

Product ID	Watt	CCT	Dimension (mm) ø l h	MRP
LAC 1015	15	3000K/4000K/6000K	72 160 160	2650
LAC 1018	18	3000K/4000K/6000K	72 160 160	2850

Available Colors ●

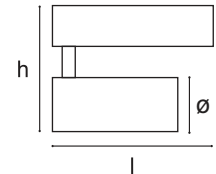

Single Phase Track (1m)/(2m)

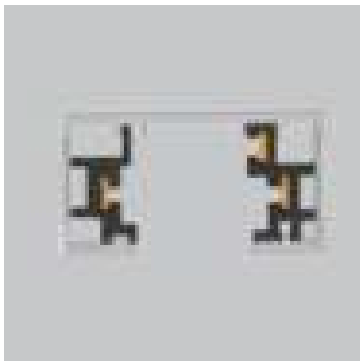

Extruded aluminium construction. Track offers separately controlled circuit with live adaptor & end cap.

Product ID	Track Length	Color	Dimension (mm) l b	MRP
TACT 1001	1m	WHITE	17.8 34.3	1100
TACT 1002	1m	BLACK	17.8 34.3	1100
TACT 2001	2m	WHITE	17.8 34.3	2200
TACT 2002	2m	BLACK	17.8 34.3	2200



Mini Joiner Single Phase



Join two sections of straight track end to end.

Product ID	Color	Dimension (mm) l b	MRP
TAMJ 001	WHITE	80 34	340
TAMJ 002	BLACK	80 34	340

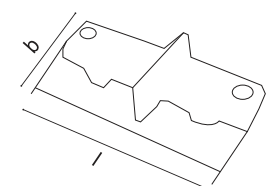

Suspension Kit

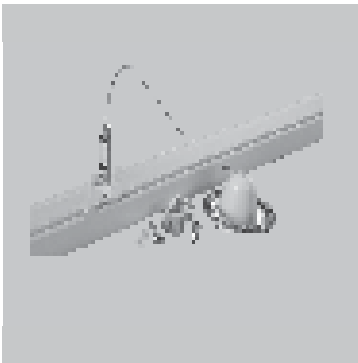

Includes track bracket, rods and suspension wires.

Product ID	CCT	Dimension (mm) l b h	MRP
TASK 3001	WHITE	62 35 59.5	935
TASK 3002	BLACK	62 35 59.5	935

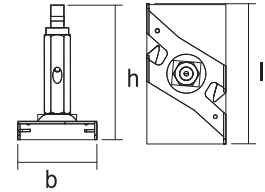

Lynx IP 20



Flexible LED striplights made of bright LED chips, high quality thermal PCB board and an unmatched quality control process. It is an IP 20 product.

Product ID	Watt	CCT	Dimension (mm) l b h	MRP
LRS 2106	6/meter (60 LED)	3000K/4000K/6000K	5000 8 1.1	200
LRS 2514	14/meter (60 LED)	3000K/4000K/6000K	5000 8 1.1	225

LRS 2105D *12Volt DC 2Amp. Driver for 6 watt LED strip light per 5 meter roll Rs. 595
 LRS 2112D *12Volt DC 4Amp. Driver for 14 watt LED strip light per 5 meter roll Rs. 1020
 LRE 101 *Lynx Recessed Extrusion per 1 meter Rs.700
 LSE 102 *Lynx Surface Extrusion per 1 meter Rs.700
 LCE 103 *Lynx Corner Extrusion per 1 meter Rs.750

Lynx IP 65



Flexible LED striplights made of bright LED chips, high quality thermal PCB board and an unmatched quality control process. It is an IP 65 product.

Product ID	Watt	CCT	Dimension (mm) l b h	MRP
LRS 2506	6/meter (60 LED)	3000K/4000K/6000K	5000 14 5	375
LRS 2514	14/meter (60 LED)	3000K/4000K/6000K	5000 14 5	475

LRS 2206D *Driver for 6watt IP 65 LED strip light per 5 meter (Price on Request)
 LRS 2214D *Driver for 14watt IP 65 LED strip light per 5 meter Rs. 4100
 LRE 201 *Lynx Recessed Extrusion per 1 meter Rs.700
 LSE 202 *Lynx Surface Extrusion per 1 meter Rs.700
 LCE 203 *Lynx Corner Extrusion per 1 meter Rs.750

Kiri



Decorative polycarbonate LED batten in rectangular shape with high efficient PC diffuser & nicely designed end caps.

Product ID	Watt	CCT	Dimension (mm) l b h	MRP
LRS 9110	10	3000K/4000K/6000K	595 22 36.5	290
LRS 9920	20	3000K/4000K/6000K	1135 22 36.5	310

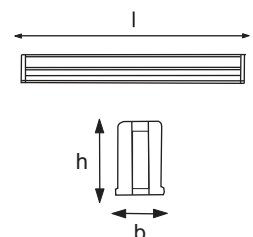

Available Colors

Lita

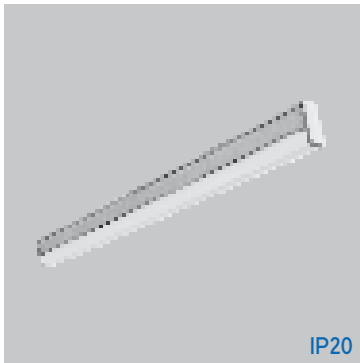

Aluminium extruded LED batten light in square shape with high efficient polycarbonate diffuser for uniform lighting.

Product ID	Watt	CCT	Dimension (mm) l b h	MRP
RBJ 100 0012	12	3000K/4000K/6000K	610 24 38	650
RBJ 100 0024	24	3000K/4000K/6000K	1176 24 38	825
RBJ 100 0036	36	3000K/4000K/6000K	1176 24 38	935

Available Colors ●

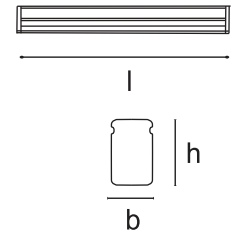

Stripo



The stripo led batten in square shape with aluminium housing & PC end cap. The luminaire and its components are designed for Indoor application. Inbuilt high efficient LEDs used with milky white diffuser for glare free high luminous output.

Product ID	Watt	CCT	Dimension (mm) l b h	MRP
LST 1240	40	3000K/4000K/6000K	1196 35.4 44	1575

Available Colors ●

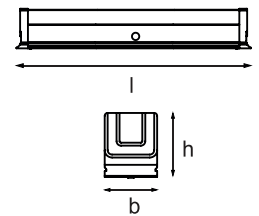



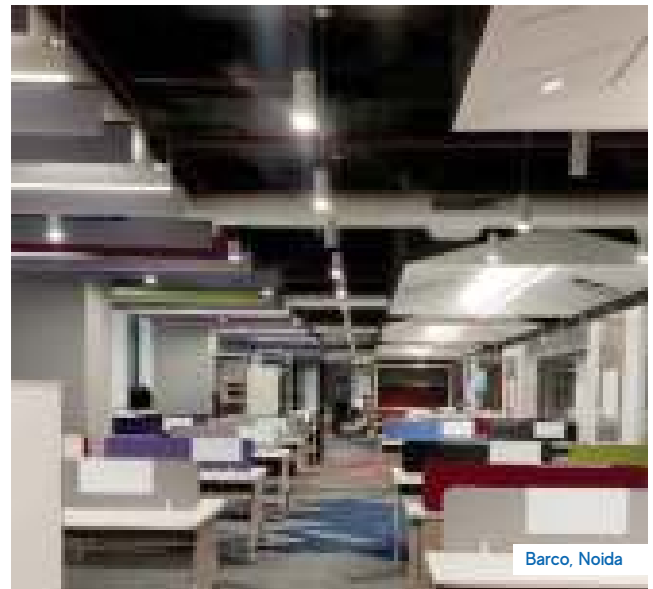

Terra



IP20

2x2 Recess Mount LED Panel is a very nicely designed product with backlit technology & low height feature to provide high light output and premium aesthetic. It's suitable for the Armstrong/ Grid ceiling.

Product ID	Watt	CCT	Cutout (mm) l x b	Dimension (mm) l b h	MRP
LTP 1036	36	3000K/4000K/6000K	575 x 575	595 595 34	2400



Available Colors

Modena



IP20

LED recessed grid - ceiling luminaire, suitable for 600 x 600 module and is enclosed with high efficient flat low glare diffuser.

Product ID	Watt	CCT	Cutout (mm) l x b	Dimension (mm) l b h	MRP
LER 2628	28	3000K/4000K/6000K	575 x 575	595 595 76	3000
LER 2636	36	3000K/4000K/6000K	575 x 575	595 595 76	3000
LER 2640	40	3000K/4000K/6000K	575 x 575	595 595 76	3700

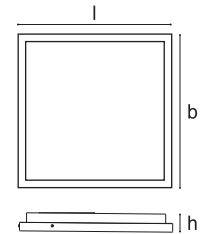

Available Colors

Modena 1x4



IP20

LED ceiling luminaire 1x4 suitable for recessed application with uniform illumination & higher efficiency.

Product ID	Watt	CCT	Cutout (mm) l x b	Dimension (mm) l b h	MRP
LER 1240	40	3000K/4000K/6000K	1175 x 275	1195 295 80	3600



Available Colors

Modena Recessed



IP20

LED recess mount luminaire comes with high efficient low glare diffuser.

Product ID	Watt	CCT	Cutout (mm) l x b	Dimension (mm) l b h	MRP
LER 2518	18	3000K/4000K/6000K	260 x 260	295 295 53	1950

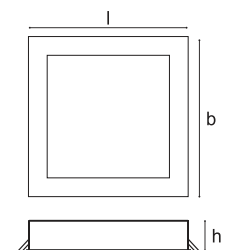

Available Colors

Modena 2 Recessed

LED Recess mount luminaire comes with high efficient flat low glare diffuser.



IP20

Product ID	Watt	CCT	Cutout (mm) l x b	Dimension (mm) l b h	MRP
LER 2524	24	3000K/4000K/6000K	580 x 280	595 298 57	2450

Available Colors

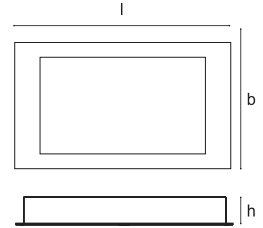

JSS, Faridabad



Accelya, Pune



ICICI Bank, Jaipur



Corpoarte Office, NCR

Moon Light Suspended



IP20

A suspended LED 2x2 luminaire made up of extruded aluminium to give a full glow effect with low glare diffuser and high efficient LEDs.

Product ID	Watt	CCT	Dimension (mm) l b h	MRP
LML 7040	40	3000K/4000K/6000K	595 595 60	6400

Available Colors

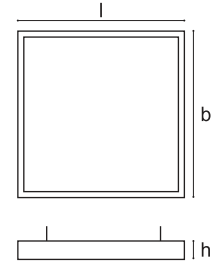

Moon Light Linear 1 Suspended



IP20

A suspended LED 1x4 luminaire made up of extruded aluminium to give a full glow effect with low glare diffuser and high efficient LEDs.

Product ID	Watt	CCT	Dimension (mm) l b h	MRP
LML 7145	45	3000K/4000K/6000K	1195 295 60	7800

Available Colors



Moon Light Linear 2 Suspended



IP20

A suspended LED 2x4 luminaire made up of extruded aluminium to give a full glow effect with low glare diffuser and high efficient LEDs.

Product ID	Watt	CCT	Dimension (mm) l b h	MRP
LML 7280	80	3000K/4000K/6000K	1195 595 60	15600

Available Colors

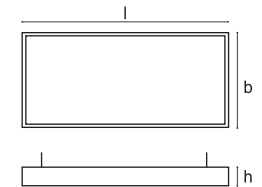

Ribbon



IP20

This contemporary aerial luminaire is a masterpiece that will add a swanky ambiance to your space. The LED fixture features excellent glare-free light distribution and lightweight extruded aluminium housing for an easy installation. Its sleek design and functionality blend in an incredibly eye-catching ribbon-like shape, making a dapper statement while saving you up to 80% on energy costs.

Product ID	Watt	CCT	Dimension (mm) l b h	MRP
LSR 1020	20	3000K/4000K/6000K	1000 70 60	15000
LSR 1030	30	3000K/4000K/6000K	1000 70 60	16000

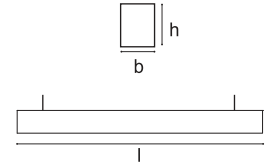

Available Colors

Techpro Direct



IP20

Suspended mounting single length individual luminaire made up of aluminium extruded natural anodized housing with matt finish & PMMA opal diffuser to give uniform light distribution.

Product ID	Watt	CCT	Dimension (mm) l b h	MRP
LTL 1030	30	3000K/4000K/6000K	1195 145 65	7800

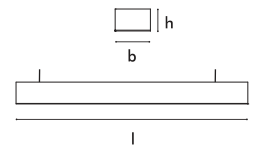

Available Colors

Techpro Up & Down



IP20

Suspended Up & Down single length individual luminaire, aluminium extruded natural anodised housing with matt finish extruded PMMA opal diffuser with uniform light distribution.

Product ID	Watt	CCT	Dimension (mm) l b h	MRP
LTL 2035	35	3000K/4000K/6000K	1195 145 65	9000

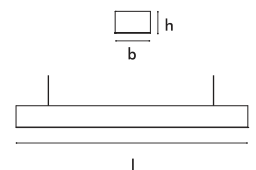

Available Colors

Sonic



IP20

Sonic a perfect suspended design with step in optics offering a combination of functionality and design. A linear lens combination gives a unique look to this product. A aesthetically pleasant product suitable in various applications like offices, restaurants, Showrooms etc.

Product ID	Watt	CCT	Beam Angles	Dimension (mm) l b h	MRP
LPS 5025	25	3000K/4000K/6000K	100°	1177 57.7 85.6	6900
LPS 5040	40	3000K/4000K/6000K	100°	1177 57.7 85.6	7300

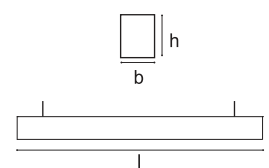

Available Colors

Verge 5



IP20

The suspended aluminum extrusion with continuous reflectors optics that offers improved efficiency with focus on reduced UGR. Various customisation available with prismatic lens in cell louvers gives flexible light option to the product.

Product ID	Watt	CCT	Beam Angles	Dimension (mm) b h	MRP
LPV 5130	30	3000K/4000K/6000K	35°	1186 57.7 85.6	9100

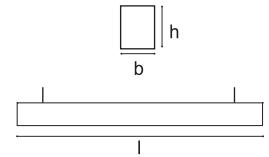

Available Colors

Verge 3



IP20

The suspended aluminum extrusion with three reflectors module optics that offers improved efficiency with focus on reduced UGR. Various customisation available with prismatic lens in cell louvers gives flexible light option to the product.

Product ID	Watt	CCT	Beam Angles	Dimension (mm) b h	MRP
LPV 5130	30	3000K/4000K/6000K	35°	1215 57.7 85.6	8800

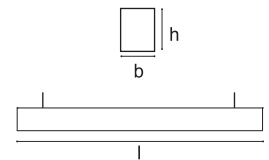

Available Colors

Tulip

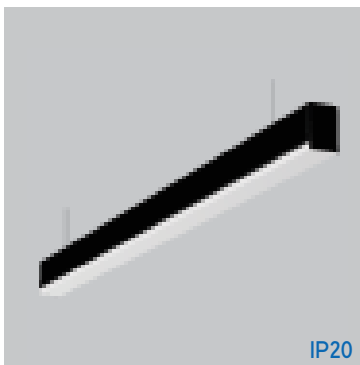

IP20

Tulip a suspended extruded aluminium housing design offers improved uniformity with soft C profile LG7 diffuser lit on all three sides offering a soft homogeneous, volumetric light distribution snap fit diffuser for ease in maintenance.

Product ID	Watt	CCT	Dimension (mm) b h	MRP
LSO 5020	20	3000K/4000K/6000K	1200 50.5 75	6100
LSO 5030	30	3000K/4000K/6000K	1200 50.5 75	6200
LSO 5040	40	3000K/4000K/6000K	1200 50.5 75	7600

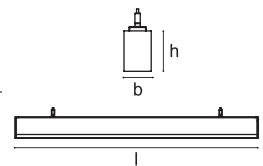

Available Colors

Strapline 50 Up & Down



IP20

The extruded aluminium housing offers a precise in-line appearance. This LED fixture comes with Direct-Indirect light distribution, high wired LED driver to be used in suspended applications.

Product ID	Watt	CCT	Dimension (mm) b h	MRP
LSL-S 5130	30	3000K/4000K/6000K	1000/1200 52.8 101	8800
LSL-S 5140	40	3000K/4000K/6000K	1000/1200 52.8 101	9000

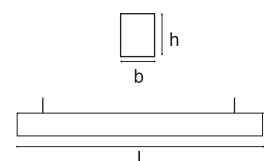

Available Colors

Strapline 50 Suspended



The extruded aluminium housing offers a precise in-line appearance. This LED fixture comes with excellent light distribution, high wired LED driver to be used in suspended/surface applications.

Product ID	Watt	CCT	Dimension (mm) l b h	MRP
LSL-S 5020	20	3000K/4000K/6000K	1000/1200 53 80	5670
LSL-S 5030	30	3000K/4000K/6000K	1000/1200 53 80	5775
LSL-S 5040	40	3000K/4000K/6000K	2000/2400 53 80	11340
LSL-S 5060	60	3000K/4000K/6000K	2000/2400 53 80	11550

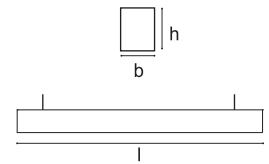

Available Colors

Strapline 50 Recessed



The extruded aluminium housing offers a precise in-line appearance. This LED fixture comes with excellent light distribution, high wired LED driver and mounting clamps to be used in recessed application.

Product ID	Watt	CCT	Cutout (mm) l x b	Dimension (mm) l b h	MRP
LSL-R 5020	20	3000K/4000K/6000K	992/1192 55	1000/1200 63 80	5670
LSL-R 5030	30	3000K/4000K/6000K	992/1192 55	1000/1200 63 80	5775
LSL-R 5040	40	3000K/4000K/6000K	1992/2392 55	2000/2400 63 80	11340
LSL-R 5060	60	3000K/4000K/6000K	1992/2392 55	2000/2400 63 80	11550

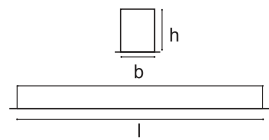

Available Colors

Strapline 35 Suspended



The extruded aluminium housing offers a precise in-line appearance. This LED fixture comes with excellent light distribution, high wired LED driver to be used in suspended/surface applications.

Product ID	Watt	CCT	Dimension (mm) l b h	MRP
LSL-S 3520	20	3000K/4000K/6000K	1200 36.5 53	4200
LSL-S 3530	30	3000K/4000K/6000K	1200 36.5 53	4800
LSL-S 3540	40	3000K/4000K/6000K	2400 36.5 53	8400
LSL-S 3560	60	3000K/4000K/6000K	2400 36.5 53	9600

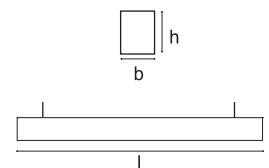

Available Colors

Strapline 35 Recessed



The extruded aluminium housing offers a precise in-line appearance. This LED fixture comes with excellent light distribution, high wired LED driver and mounting clamps to be used in recessed application.

Product ID	Watt	CCT	Cutout (mm) l x b	Dimension (mm) l b h	MRP
LSL-R 3520	20	3000K/4000K/6000K	1192 38	1200 46.5 57	4200
LSL-R 3530	30	3000K/4000K/6000K	1192 38	1200 46.5 57	4800
LSL-R 3540	40	3000K/4000K/6000K	2392 38	2400 46.5 57	8400
LSL-R 3560	60	3000K/4000K/6000K	2392 38	2400 46.5 57	9600

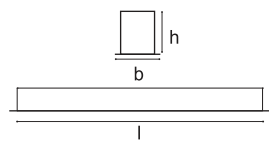

Available Colors

Pill Suspended



IP20

Round extruded aluminium housing with PMMA diffuser. High efficient LEDs for uniform light distribution .

Product ID	Watt	CCT	Dimension (mm) ø h	MRP
ALP-S 4130	30	3000K/4000K/6000K	400 60	8000
ALP-S 5145	45	3000K/4000K/6000K	500 60	11000
ALP-S 6156	56	3000K/4000K/6000K	600 60	14000
ALP-S 9180	80	3000K/4000K/6000K	900 60	22000
ALP-S 12100	100	3000K/4000K/6000K	1170 60	32000

Available Colors

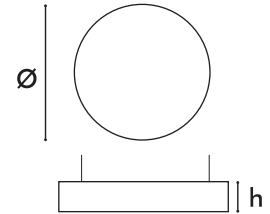

Pill Recessed



IP20

Round luminaire aluminium, rolled profile, seamlessly welded housing with integrated tool-less suspension height adjustment. Highly reflective coating for improved efficiency with high transmission factor PMMA opal diffuser. Rolled aluminium frame accessory along with fixture for ease in installation.

Product ID	Watt	CCT	Cutout (mm) ø	Dimension (mm) ø h	MRP
ALP-R 4230	30W	3000K/4000K/6000K	410	400 65	9800
ALP-R 5245	45W	3000K/4000K/6000K	510	500 65	13500
ALP-R 6256	56W	3000K/4000K/6000K	610	600 65	19000

Available Colors

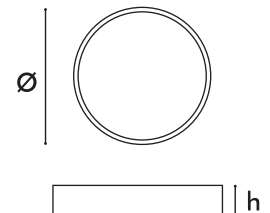

Pill Surface



IP20

Round luminaire aluminium, rolled profile, seamlessly welded housing with integrated tool-less suspension height adjustment. Highly reflective coating for improved efficiency with high transmission factor diffuser. Rolled aluminium frame accessory along with fixture for ease in installation.

Product ID	Watt	CCT	Dimension (mm) ø h	MRP
ASP 4330	30	3000K/4000K/6000K	400 110	9050
ASP 5345	45	3000K/4000K/6000K	500 110	12500
ASP 6350	50	3000K/4000K/6000K	600 110	16700
ASP 9380	80	3000K/4000K/6000K	900 110	27000

Available Colors

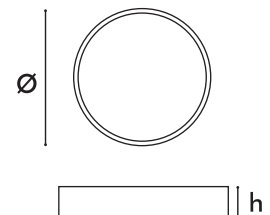

Ripple

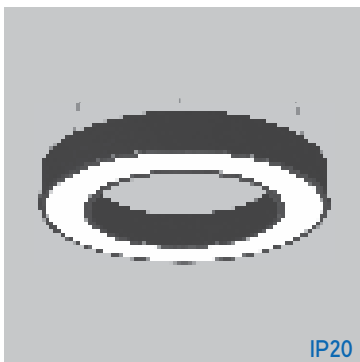

IP20

Round extruded aluminium housing with diffuser. Smart circular ring gives functional decorative look. Also diffuser is so fixed to provide uniform light output.

Product ID	Watt	CCT	Dimension (mm) ø h	MRP
ARL 6030	30	3000K/4000K/6000K	600 60	18000
ARL 9055	55	3000K/4000K/6000K	900 60	28000
ARL 12080	80	3000K/4000K/6000K	1170 60	37000
ARL 15000		3000K/4000K/6000K	1500 60	52500
ARL 18000	As per Request	3000K/4000K/6000K	1800 60	63000
ARL 20000		3000K/4000K/6000K	2000 60	70000
ARL 24000		3000K/4000K/6000K	2400 60	84000

Available Colors

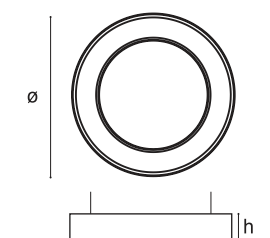

Crescent



Extruded Aluminum housing in Circular Arc form with high transmissivity Diffuser. High efficient LEDs with uniform light distribution.

Product ID	Watt	CCT	Dimension (mm) l b h	MRP
ACL 6030	30	3000K/4000K/6000K	801.3 301.6 60	8600

Available Colors

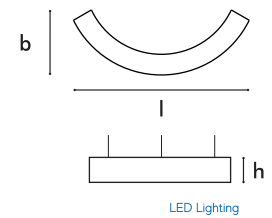

Trio



Triangular extruded aluminium housing with soft corner and high transmissivity diffuser. High efficient LEDs for uniform light.

Product ID	Watt	CCT	Dimension (mm) l b h	MRP
ATL-S 3030	30W	3000K/4000K/6000K	511 450 60	12000

Available Colors

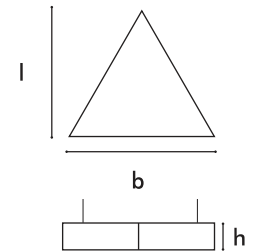

Hexo



The extruded aluminium housing in hexagon shape with high transmissivity diffuser. High efficient LEDs for uniform light distribution.

Product ID	Watt	CCT	Dimension (mm) l b h	MRP
AHL 6040	40	3000K/4000K/6000K	672 582 60	14800

Available Colors

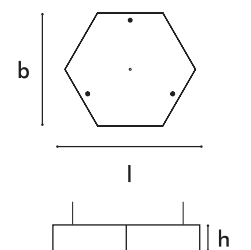

Recto



Rectangular shape extruded aluminium housing with high transmissivity diffuser gives functional look. Also high efficient LEDs & diffuser combination gives smooth & uniform light.

Product ID	Watt	CCT	Dimension (mm) l b h	MRP
ARL 6330	30	3000K/4000K/6000K	600 300 60	13200

Available Colors

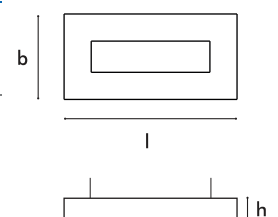

Frame



Square extruded aluminium housing with high transmissivity diffuser. Geometrical shape blends perfectly with ceiling design & gives unique product look.

Product ID	Watt	CCT	Dimension (mm) l b h	MRP
AFL 5030	30	3000K/4000K/6000K	500 500 60	12100

Available Colors

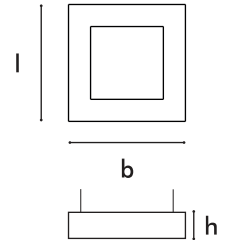

Petal



Extruded aluminium housing designed in leaf shape for unique & decorative look. High transmissivity diffuser is used to give smooth & glare free light output.

Product ID	Watt	CCT	Dimension (mm) l b h	MRP
APL 6330	30W	3000K/4000K/6000K	609 307 60	14800

Available Colors

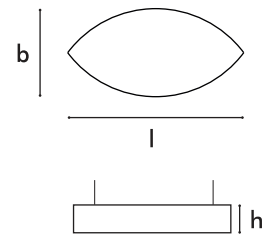



Task Us, Mohali



Task Us, Mohali



Intas, Ahmedabad



KTM, Pune



CLSA, Pune



Ecolab, Pune



IGI Airport-T3, Delhi



Make My Trip, Gurugram



Kalyan Mantapa, Bangalore



LG Chem, Gurugram



Compu Com, Pune

Blaze



The BLAZE modular Highbay is a hassle free replacement of general highbay in industries. Blaze comes with light efficacy of 150 lm/w & customized LED Light module and various precision lens optics packages. Blaze comes with decorative design and multiple color option. Aluminum die-cast module with unique designed heat sink fins provide thermal management to natural convection. Decorative Polycarbonate End caps give an aesthetic appeal to the product. Various hanging angles are provided in the mounting clamp for mounting light in different angles. Each module comes with its separate driver section. Precision lens optic system optimizes illumination for open floor, racked or aisle way applications.

Product ID	Watt	CCT	Beam Angles	Dimension (mm) l b h	MRP
LBL-N 040	40	5700K	60°/90°	217 228 100	5000
LBL-N 050	50	5700K	60°/90°	217 228 100	5300

Available Colors ●

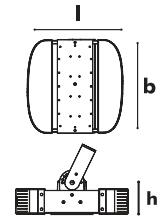

Blaze



The BLAZE modular Highbay is a hassle free replacement of general highbay in industries. Blaze comes with light efficacy of 150 lm/w & customized LED Light module and various precision lens optics packages. Blaze comes with decorative design and multiple color option. Aluminum die-cast module with unique designed heat sink fins provide thermal management to natural convection. Decorative Polycarbonate End caps give an aesthetic appeal to the product. Various hanging angles are provided in the mounting clamp for mounting light in different angles. Each module comes with its separate driver section. Precision lens optic system optimizes illumination for open floor, racked or aisle way applications.

Product ID	Watt	CCT	Beam Angles	Dimension (mm) l b h	MRP
LBL-N 080	80	5700K	60°/90°	325 228 100	9000
LBL-N 0100	100	5700K	60°/90°	325 228 100	9500

Available Colors ●

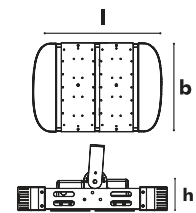

Blaze



The BLAZE modular Highbay is a hassle free replacement of general highbay in industries. Blaze comes with light efficacy of 150 lm/w & customized LED Light module and various precision lens optics packages. Blaze comes with decorative design and multiple color option. Aluminum die-cast module with unique designed heat sink fins provide thermal management to natural convection. Decorative Polycarbonate End caps give an aesthetic appeal to the product. Various hanging angles are provided in the mounting clamp for mounting light in different angles. Each module comes with its separate driver section. Precision lens optic system optimizes illumination for open floor, racked or aisle way applications.

Product ID	Watt	CCT	Beam Angles	Dimension (mm) l b h	MRP
LBL-N 0120	120	5700K	60°/90°	422 228 100	13500
LBL-N 0150	150	5700K	60°/90°	422 228 100	14250

Available Colors ●

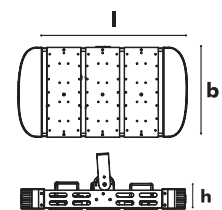

Blaze



The BLAZE modular Highbay is a hassle free replacement of general highbay in industries. Blaze comes with light efficacy of 150 lm/w & customized LED Light module and various precision lens optics packages. Blaze comes with decorative design and multiple color option. Aluminum die-cast module with unique designed heat sink fins provide thermal management to natural convection. Decorative Polycarbonate End caps give an aesthetic appeal to the product. Various hanging angles are provided in the mounting clamp for mounting light in different angles. Each module comes with its separate driver section. Precision lens optic system optimizes illumination for open floor, racked or aisle way applications.

Product ID	Watt	CCT	Beam Angles	Dimension (mm) l b h	MRP
LBL-N 0200	200	5700K	60°/90°	522 228 100	19000

Available Colors ●

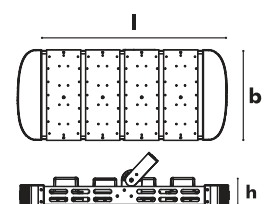

Delphi



IP66

Elegant round High bay luminaire design along with lens & toughened glass which is designed to replace traditional High bays. The system delivers simple, point to point replacement with easy installation methods of hook, pendants and brackets. Unique matt finish powder coating gives alluring look to the fixture. A Multi electronic driver in the housing provides extra performance and unique feature to the product.

Product ID	Watt	CCT	Beam Angles	Dimension (mm) ø h	MRP
LDH 060	60	3000K/4000K/5700K	60°/90°	275 122	6000
LDH 080	80	3000K/4000K/5700K	60°/90°	275 122	7500
LDH 100	100	3000K/4000K/5700K	60°/90°	275 122	8000

Available Colors ●

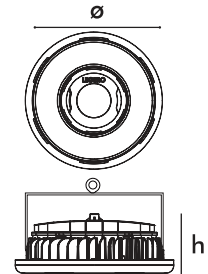

Roto



IP66

Elegant round Highbay luminaire design along with lenses & glasses is designed to replace traditional Highbays. The system delivers simple, point to point replacement with easy installation methods of hook, pendants and brackets. Unique matt finish powder coating gives alluring look to the fixture.

Product ID	Watt	CCT	Beam Angles	Dimension (mm) ø h	MRP
LRO 080	80	3000K/5700K	60°/90°	276 140	6800
LRO 100	100	3000K/5700K	60°/90°	320 130	7600
LRO 120	120	3000K/5700K	60°/90°	320 130	7800
LRO 150	150	3000K/5700K	60°/90°	365 150	10500
LRO 200	200	3000K/5700K	60°/90°	365 150	13750

Available Colors ●

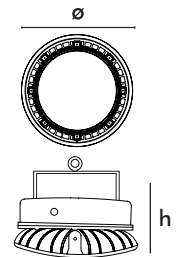

Roto 2



IP66

Elegant round Highbay luminaire design along with lens module. The system delivers simple, point to point replacement with easy installation methods of hook, pendants and brackets. Unique matt finish powder coating gives alluring look to the fixture.

Product ID	Watt	CCT	Beam Angles	Dimension (mm) ø h	MRP
LRO 2080	80	3000K/5700K	90°	276 140	7000
LRO 2100	100	3000K/5700K	90°	320 130	8000
LRO 2120	120	3000K/5700K	90°	320 130	8400
LRO 2150	150	3000K/5700K	90°	365 150	11000
LRO 2200	200	3000K/5700K	90°	365 150	14800

Available Colors ●

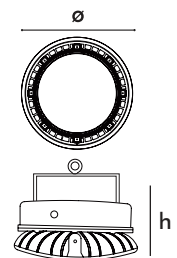

Axel



IP66

Axel is an Innovative LED well glass luminaire for direct replacement of 100W Conventional Fixture. Axel has the potential to save up to 60% of energy without compromising lighting parameters in the existing installation. Axel is widely used in various applications in diversified sector. It is developed by using advance technology and requisition tool in compliance with quality standards. Available in both opal & clear vandal resistant polycarbonate diffuser.

Product ID	Watt	CCT	Dimension (mm) ø h	MRP
LAX-O 040 (Opal)	40	6000K	120 180	3450
LAX-O 040 (Clear)	40	6000K	120 180	3450

Available Colors ●

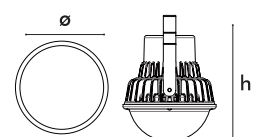

Strix



The Strix (Industrial Batten) is the highly efficient and reliable IP65 led lighting solution. The luminaire and its components are designed for Indoor & Outdoor application. Inbuilt high efficient LEDs used with PC housing & milky white diffuser for glare free luminous output.

Product ID	Watt	CCT	Dimension (mm) b h	MRP
LSB 1220	20	3000K/4000K/6000K	633 54 53	2000
LSB 1240	40	3000K/4000K/6000K	1217 54 53	2800

Suspension Kit - Rs. 550

Available Colors

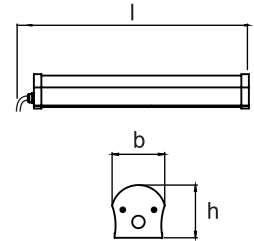

Astra-LW



ASTRA-LW Floodlight is a universal, compact range of floodlights with two type of beam angle lens. The range is suitable for various applications around buildings, ideal for facade lighting as well as lighting gardens, paths near to buildings, garages, entrance ways, security lighting and drives. This IP 66 product comes with fixture efficacy of 110 lm/w.

Product ID	Watt	CCT	Beam Angles	Dimension (mm) b h	MRP
LAS 0030	30	3000K/5700K	60°/90°	181 141 112	4300
LAS 0050	50	3000K/5700K	60°/90°	181 141 112	6200

Available Colors

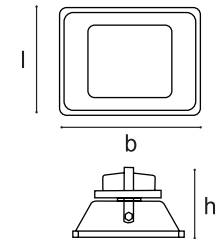

Astra-MW



ASTRA-MW Floodlight is a universal, compact range of floodlights with two type of beam angle lens. The range is suitable for various applications around buildings, ideal for facade lighting as well as lighting gardens, paths near to buildings, garages, entrance ways, security lighting and drives. This IP 66 product comes with fixture efficacy of 110 lm/w.

Product ID	Watt	CCT	Beam Angles	Dimension (mm) b h	MRP
LAS 0100	100	3000K/5700K	60°/90°	270 220 128	9500
LAS 0150	150	3000K/5700K	60°/90°	365 265 122	13900
LAS 0200	200	3000K/5700K	60°/90°	365 265 122	21200

Available Colors

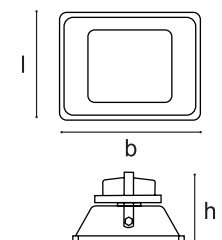

Astra-HW



ASTRA-HW Floodlight is a universal, compact range of floodlights with two type of beam angle lens. The range is suitable for various applications around buildings, ideal for facade lighting as well as lighting gardens, paths near to buildings, garages, entrance ways, security lighting and drives. This IP 66 product comes with fixture efficacy of 110 lm/w.

Product ID	Watt	CCT	Beam Angles	Dimension (mm) b h	MRP
LAS 0250	250	3000K/5700K	60°/90°	428 327 160	26000
LAS 0300	300	3000K/5700K	60°/90°	428 327 160	27000
LAS 0350	350	3000K/5700K	60°/90°	520 330 165	32900
LAS 0400	400	3000K/5700K	60°/90°	520 330 165	35700

Available Colors

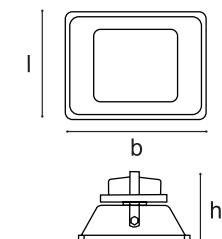

Beam



IP66

IP 66 LED flood light with Elegant squarish design with modular lens. Powder coated finish with cradle mounting facility.

Product ID	Watt	CCT	Beam Angles	Dimension (mm) l b h	MRP
LSK 1030	30	6000K	75°	197 188 37	2450
LSK 1050	50	6000K	75°	238 228 37	2600
LSK 1100	100	6000K	60°	292 282 50	4200
LSK 1200	200	6000K	75°	363 352 50	8100

Available Colors ●

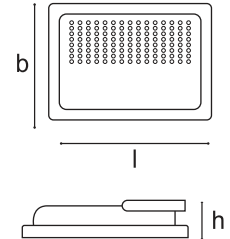

Bento



IP66

IP 66 LED street light with high pressure aluminium die-cast body and toughened glass. Powered with high efficacy LED chips to give the best output.

Product ID	Watt	CCT	Beam Angles	Pole Dia (mm) ø	Dimension (mm) l b h	MRP
LRS 99020	20	6000K	100°	40	320 110 60	1550
LRS 99025	25	6000K	100°	40	320 110 60	1600
LRS 99030	30	6000K	100°	40	320 110 60	1750

Available Colors ●

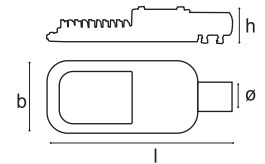

Bento



IP66

IP 66 LED street light with high pressure aluminium die-cast body and toughened glass. Powered with high efficacy LED chips to give the best output. Back driver opening suitable for easy replacement.

Product ID	Watt	CCT	Beam Angles	Pole Dia (mm) ø	Dimension (mm) l b h	MRP
LRS 99040	40	6000K	100°	42	385 155 62	2250
LRS 99050	50	6000K	100°	42	385 155 62	2850
LRS 99060	60	6000K	105°	54	400 210 76	4800
LRS 99070	70	6000K	105°	54	400 210 76	4900
LRS 99090	90	6000K	110°	54	400 210 76	5200

Available Colors ●

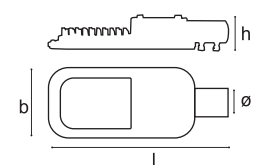

Cleo



IP66

IP 66 LED street light with high pressure aluminium die cast body and lens toughened glass. Powered with high power LED chips to give the best output. Cleo comes with light efficacy of 110 lm/w. Wider spread angle of lens with toughened glass provide extra coverage of light on road.

Product ID	Watt	CCT	Beam Angles	Pole Dia (mm) ø	Dimension (mm) l b h	MRP
LCL 0018	18	5700K	125° x 45°	40	320 110 60	1900
LCL 0024	24	5700K	125° x 45°	40	320 110 60	2050
LCL 0036	36	5700K	125° x 45°	42	385 155 62	2850
LCL 0045	45	5700K	125° x 55°	42	385 155 62	3450

Available Colors ●

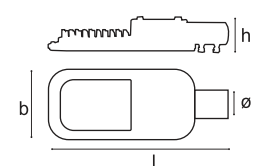

Cleo



Unique designed Street light with High Power LED and back/front driver opening comes with all the options suitable for lighting outdoor application. Wider spread angle of lens with toughened glass provide extra coverage of light on roads. Aluminium Die cast Housing with unique heat sink fins structure provides thermal management to natural convection. This IP 66 product comes with fixture efficacy of 110 lm/w.

Product ID	Watt	CCT	Beam Angles	Pole Dia (mm) \varnothing	Dimension (mm) \varnothing h	MRP
LCL 0060	60	5700K	145° x 65°	54	400 210 76	5400
LCL 0072	72	5700K	145° x 65°	54	400 210 76	5800
LCL 0090	90	5700K	145° x 55°	54	400 210 76	7000
LCL 0110	110	5700K	145° x 60°	50	400 195 100	9000
LCL 0140	140	5700K	145° x 60°	50	440 230 108	11000
LCL 0190	190	5700K	145° x 60°	60	502 257 108	18500

Available Colors ●

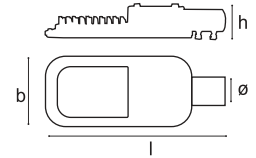

Mantis



An ultra compact, IP 66, LED light luminaire. Its corrosion proof, die cast aluminium composite construction makes it ideal for the harshest corrosive environment. Spike available to ease the installation.

Product ID	Watt	CCT	Beam Angles	Dimension (mm) \varnothing l h	MRP
LSM 1007	7	3000K/4000K/6000K	40°	49 110 255	1350

Available Colors ●

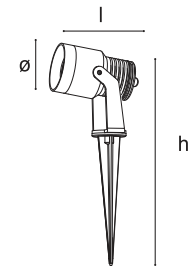

Pictor



An ultra compact, IP 66, LED light luminaire. Its corrosion proof, die cast aluminium composite construction makes it ideal for the harshest corrosive environment. Spike available to ease the installation.

Product ID	Watt	CCT	Beam Angles	Dimension (mm) \varnothing l h	MRP
LSO 3010	10	3000K	50°	75 138 245	3000
LSO 3015	15	3000K	50°	75 138 245	3800

Available Colors ●

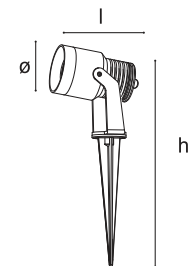

Oreon



Cylindrical type wall mounted IP 65 luminaire made of high grade aluminium extrusion & die cast aluminium heatsink for effective heat dissipation with high efficient COB for better output. The luminaire comes with toughened glass.

Product ID	Watt	CCT	Beam Angles	Dimension (mm) \varnothing l h	MRP
LCO 4408	8	3000K/4000K/6500K	50°	80 115 192	3450
LCO 4412	12	3000K/4000K/6500K	50°	80 115 192	3600
LCO 4415	15	3000K/4000K/6500K	50°	80 115 192	4200

Available Colors ●

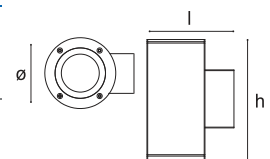

Oreon Up & Down



Cylindrical type wall mounted IP 65 up-down luminaire made of high grade aluminium extrusion & die cast aluminium heatsink for effective heat dissipation with high efficient COB for better output. The luminaire comes with toughened glass.

Product ID	Watt	CCT	Beam Angles	Dimension (mm) ø l h	MRP
LCO 4516	2x8	3000K/4000K/6500K	50°	80 115 200	4580
LCO 4524	2x12	3000K/4000K/6500K	50°	80 115 240	5200
LCO 4530	2x15	3000K/4000K/6500K	50°	80 115 240	6350

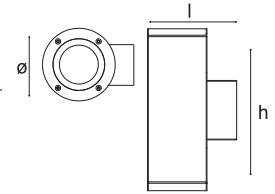

Available Colors ●

Oreon Surface



Cylindrical type ceiling mounted IP 65 luminaire made of high grade aluminium extrusion & die cast aluminium heatsink for effective heat dissipation with high efficient COB for better output. The luminaire comes with toughened glass.

Product ID	Watt	CCT	Beam Angles	Dimension (mm) ø h	MRP
LCO 4308	8	3000K/4000K/6500K	50°	80 186	3450
LCO 4312	12	3000K/4000K/6500K	50°	80 186	3750
LCO 4315	15	3000K/4000K/6500K	50°	80 186	4300

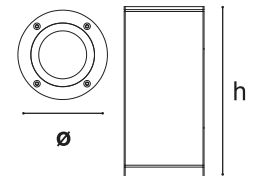

Available Colors ●

Kube



Rectangular type wall mounted IP 65 luminaire made of high grade aluminium extrusion & die cast aluminium heatsink for effective heat dissipation with high efficient COB for better output. The luminaire comes with toughened glass.

Product ID	Watt	CCT	Beam Angles	Dimension (mm) l b h	MRP
LSO 3207	8	3000K/4000K/6500K	50°	80 120 192	3550
LSO 3212	12	3000K/4000K/6500K	50°	80 120 192	4000
LSO 3215	15	3000K/4000K/6500K	50°	80 120 192	4250

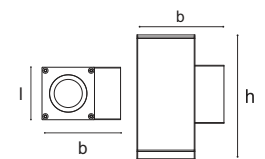

Available Colors ●

Kube Up & Down



Rectangular type wall mounted IP 65 up-down luminaire made of high grade aluminium extrusion & die cast aluminium heatsink for effective heat dissipation with high efficient COB for better output. The luminaire comes with toughened glass.

Product ID	Watt	CCT	Beam Angles	Dimension (mm) l b h	MRP
LSO 3316	2x8	3000K/4000K/6500K	50°	80 115 198	4800
LSO 3324	2x12	3000K/4000K/6500K	50°	80 115 198	5350
LSO 3330	2x15	3000K/4000K/6500K	50°	80 115 198	6700

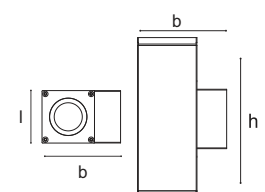

Available Colors ●

Kube Surface



Rectangular type ceiling mounted IP 65 luminaire made of high grade aluminium extrusion & die cast aluminium heatsink for effective heat dissipation with high efficient COB for better output. The luminaire comes with toughened glass.

Product ID	Watt	CCT	Beam Angles	Dimension (mm) b h	MRP
LSO 3408	8	3000K/4000K/6500K	50°	80 80 186	3700
LSO 3412	12	3000K/4000K/6500K	50°	80 80 186	4150
LSO 3415	15	3000K/4000K/6500K	50°	80 80 186	4450

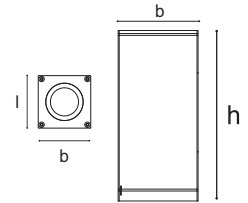

Available Colors ●

Sia



IP 65 SIA (bulk head) light is integrated with high efficient LEDs with milky diffuser covering. The fixture has integrated driver and is easy on maintenance.

Product ID	Watt	CCT	Dimension (mm) b h	MRP
LBH 0012	12	6000K	189 109 67	1250
LBH 0015	15	6000K	189 109 67	1450
LBH 0018	18	6000K	189 109 67	2100

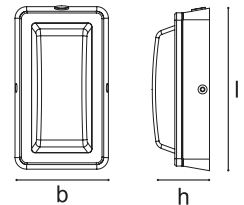

Available Colors ●

Edge



Square IP65 Edge (Steplight) is integrated with high efficient LEDs with die-cast aluminium housing & clear glass to achieve better light distribution.

Product ID	Watt	CCT	Cutout (mm) x b x h	Dimension (mm) b h	MRP
LSA 3003	3	3000K/4000K/6000K	78 x 73 x 40	84 84 43	580

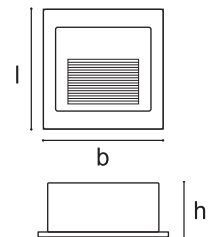

Available Colors ●

Brick



IP 65 designer step light with integrated high efficient LED designed for safety & style for stairways, patios, decks, balcony areas & walkways.

Product ID	Watt	CCT	Dimension (mm) b h	MRP
LOD 3004	4	3000K/4000K/6000K	99 99 61	1550
LOD 3006	6	3000K/4000K/6000K	99 99 61	1650

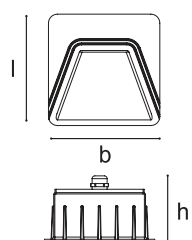

Available Colors ●

Elava



IP67

IP 67 in ground LED luminaire die cast housing stainless steel cover, anti-corrosion resistant, tempered clear glass with optical lens & Integrated driver.

Product ID	Watt	CCT	Beam Angles	Cutout (mm) \varnothing	Dimension (mm) \varnothing h	MRP
LOD 44501	1	3000K/4000K/6000K	16°/24°/36°	45.8	49 90.5	3800



Available Colors ●

Elava



IP67

IP 67 in ground LED luminaire die cast housing stainless steel cover, anti-corrosion resistant, tempered clear glass with optical lens & Integrated driver.

Product ID	Watt	CCT	Beam Angles	Cutout (mm) \varnothing	Dimension (mm) \varnothing h	MRP
LOD 44503	3	3000K/4000K/6000K	16°/24°/36°	77.8	83.8 129.4	5600
LOD 44509	9	3000K/4000K/6000K	16°/24°/36°	77.8	83.8 129.4	7800

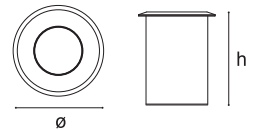

Available Colors ●

Elava



IP67

IP 67 in ground LED luminaire die cast housing stainless steel cover, anti-corrosion resistant, tempered clear glass with optical lens & Integrated driver.

Product ID	Watt	CCT	Beam Angles	Cutout (mm) \varnothing	Dimension (mm) \varnothing h	MRP
LOD 44512	12	3000K/4000K/6000K	16°/24°/36°	118	125.5 129.5	10500

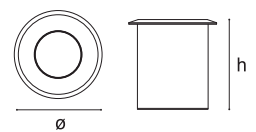

Available Colors ●

Elava



IP67

IP 67 in ground LED luminaire die cast housing stainless steel cover, anti-corrosion resistant, tempered clear glass with optical lens & Integrated driver.

Product ID	Watt	CCT	Beam Angles	Cutout (mm) \varnothing	Dimension (mm) \varnothing h	MRP
LOD 44515	15	3000K/4000K/6000K	16°/24°/36°	148.5	154.8 152	12500
LOD 44518	18	3000K/4000K/6000K	16°/24°/36°	148.5	154.8 152	14000

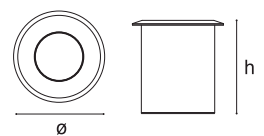

Available Colors ●

Mushroom



IP 65 LED bollard is suitable for landscape stabilized lighting applications. Luminaire is made of high grade corrosion resistant powder coated aluminium body with UV stabilized vandal proof PC diffuser.

Product ID	Watt	CCT	Dimension (mm) ø h	MRP
LBM 7009	9	3000K/6000K	150 600	7950

Available Colors ●

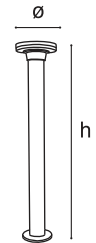

Fern



IP 65 LED bollard is suitable for landscape stabilized lighting applications. Luminaire is made of high grade corrosion resistant powder coated aluminium body with UV stabilized vandal proof PC diffuser.

Product ID	Watt	CCT	Dimension (mm) ø h	MRP
LBF 7010	10	3000K/6000K	122 600	6200

Available Colors ●

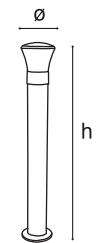

Torch



IP 65 LED bollard is suitable for landscape stabilized lighting applications. Luminaire is made of high grade corrosion resistant powder coated aluminium body with UV stabilized vandal proof PC diffuser.

Product ID	Watt	CCT	Dimension (mm) ø h	MRP
LBT 7010	10	3000K/6000K	175 600	7200

Available Colors ●

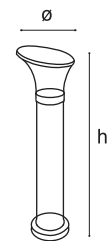

Ring Mini



Post top fixture for pole mounted application. Aluminium housing with corrosion resistant powder coat and UV stabilised vandal proof milky diffuser. IP65 protection suitable for outdoor application.

Product ID	Watt	CCT	Pole Dia (Inner) (mm) ø	Dimension (mm) ø h	MRP
LPT 4530	30	3000K/4000K/6000K	58.5	407 210	15000

Available Colors ●

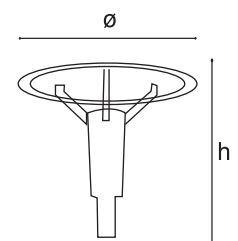

Ring



IP65

Post top fixture for pole mounted application. Aluminium housing with corrosion resistant powder coat and UV stabilised vandal proof milky diffuser. IP65 protection suitable for outdoor application.

Product ID	Watt	CCT	Pole Dia (Inner) (mm) ø	Dimension (mm) ø h	MRP
LPT 6560	60	3000K/4000K/6000K	77.5	575 370	24000

Available Colors ●

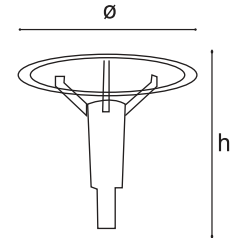

Marshall



IP65

Post top fixture for pole mounted application. Aluminium housing with corrosion resistant powder coat and UV stabilised vandal proof milky. IP65 protection suitable for outdoor application.

Product ID	Watt	CCT	Pole Dia (Inner) (mm) ø	Dimension (mm) ø h	MRP
LPM 4525	25	3000K/4000K/6000K	66	350 470	7050
LPM 4530	30	3000K/4000K/6000K	66	350 470	7650

Available Colors ●

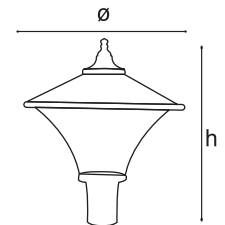

Marshall



IP65

Post top fixture for pole mounted application. Aluminium housing with corrosion resistant powder coat and UV stabilised vandal proof milky. IP65 protection suitable for outdoor application.

Product ID	Watt	CCT	Pole Dia (Inner) (mm) ø	Dimension (mm) ø h	MRP
LPM 4545	45	3000K/4000K/6000K	76.5	450 520	10500

Available Colors ●

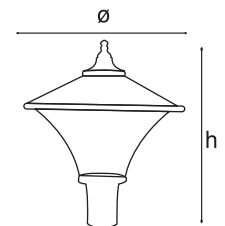

Bruno



IP65

Post top fixture for pole mounted application. Aluminium housing with corrosion resistant powder coat and UV stabilised vandal proof clear diffuser. IP65 protection suitable for outdoor application.

Product ID	Watt	CCT	Pole Dia (Inner) (mm) ø	Dimension (mm) ø h	MRP
LPB 1030	30	3000K/4000K/6000K	76	370 450	7650

Available Colors ●

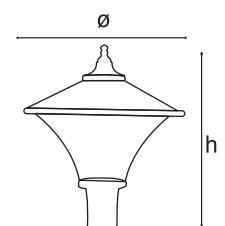

Bruno 2



Post top fixture for pole mounted application. Aluminium housing with corrosion resistant powder coat and UV stabilized vandal proof clear diffuser. IP65 protection suitable for outdoor application.

Product ID	Watt	CCT	Pole Dia (Inner) (mm) \varnothing	Dimension (mm) \varnothing h	MRP
LPB 1125	25	3000K/4000K/6000K	66	350 470	7050
LPB 1130	30	3000K/4000K/6000K	66	350 470	7650

Available Colors ●

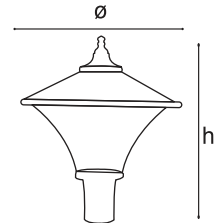

Ogee



Post top fixture for pole mounted application. Aluminium housing with corrosion resistant powder coat and UV Stabilized Injection moulded Poly Carbonate with Prismatic Cut. IP66 protection suitable for outdoor application.

Product ID	Watt	CCT	Pole Dia (Inner) (mm) \varnothing	Dimension (mm) \varnothing h	MRP
LPO 3525	25	3000K/4000K/6000K	70	332 473	10200

Available Colors ●

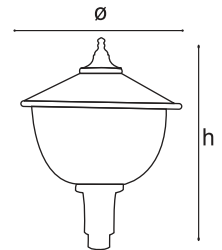

Bolt



IP 65 Lamp Post is suitable for outdoor lighting applications. Luminaire is made in spin aluminium housing with corrosion resistant powder coated and UV stabilized vandal proof clear PC diffuser.

Product ID	Watt	CCT	Pole Dia (Inner) (mm) \varnothing	Dimension (mm) \varnothing h	MRP
LPB 4045	45	3000K/4000K/6000K	69	450 680	20500

Available Colors ●

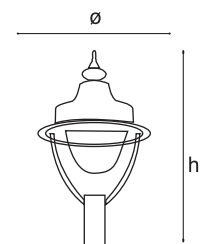

Titan



IP 65 Lamp Post is suitable for outdoor lighting applications. Luminaire is made in die-cast aluminium housing with corrosion resistant powder coated and UV stabilized vandal proof PC diffuser.

Product ID	Watt	CCT	Pole Dia (Inner) (mm) \varnothing	Dimension (mm) l b h	MRP
LPT 3045	45	3000K/4000K/6000K	78	315 315 690	24000

Available Colors ●

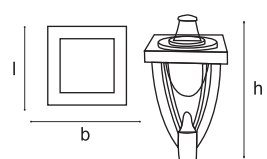

Hornet



IP 65 Lamp Post is suitable for outdoor lighting applications. Luminaire is made in spin aluminium housing with corrosion resistant powder coated and UV stabilized vandal proof clear PC diffuser.

Product ID	Watt	CCT	Dimension (mm) ø h	MRP
LHT 1050	50	3000K/4000K/5700K	625 630	18500
LHT 1090	90	3000K/4000K/5700K	625 630	21500

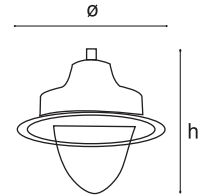

Available Colors ●



Municiple Corporation, Chandigarh



Ahmedabad, University



Matshya Narayan, Nepal



IGI Airport-T3 to T2, Delhi



PCMC, Pune



Gov. Street Lighting, W.B.

D Lite



The decorative luminaire suitable for LED bulbs available in different color options. Designer product suitable for various interior intent size option offers flexibility with respect to product application. Neat design with minimalistic approach.

Product ID	Watt	CCT	Dimension (mm) ø h	MRP
LDTE 300	9/12/15	3000K/4000K/6000K	305 185	3200
LDTE 380	9/12/15	3000K/4000K/6000K	373 205	4250
LDTE 425	9/12/15	3000K/4000K/6000K	425 210	5820
LDTE 600	9/12/15	3000K/4000K/6000K	600 320	9400

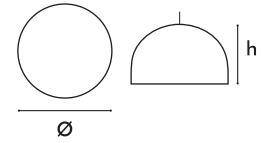

Available Colors Other colors as per request

Zeta



The decorative luminaire suitable for LED bulbs available in different color options. Inspired by water droplet, fixture has fluid design intent. Softness in design makes it suitable for almost any interior fit out.

Product ID	Watt	CCT	Dimension (mm) ø h	MRP
LZTE 3030	9/12/15	3000K/4000K/6000K	257 210	3360
LZTE 3020	9/12/15	3000K/4000K/6000K	368 280	4490
LZTE 3010	9/12/15	3000K/4000K/6000K	420 280	5590

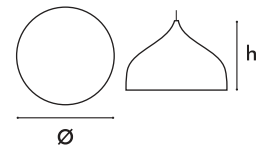

Available Colors Other colors as per request

Mole



The decorative luminaire suitable for LED bulbs available in different color options. Compact and cute design which can be used in a cluster. Simple and yet elegant, Mole can be used on various breakout areas of both residential and commercial fit outs.

Product ID	Watt	CCT	Dimension (mm) ø h	MRP
LMOL 205	9/12/15	3000K/4000K/6000K	205 175	3230

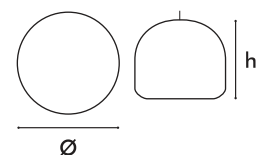

Available Colors Other colors as per request

Tope



The decorative luminaire suitable for LED bulbs available in different color options. Tope with industrial touch and robust feel is inspired from grunge design.

Product ID	Watt	CCT	Dimension (mm) ø h	MRP
LTOP 405	9/12/15	3000K/4000K/6000K	405 265	5500

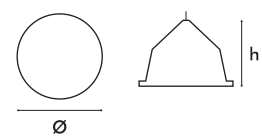

Available Colors Other colors as per request



Private

DELHI INTERNATIONAL AIRPORT TERMINAL-3	STRYKER	TASKUS	HONDA	HUL			
COOPER	PRAVIN MASALA	THYSSENKRUPP	INDIANA GRATINGS	PIAGGIO			
ARISTOCRAT	DELOITTE	HAWAS MEDIA	WILEY	PWC	IBBIBO	SCHNEIDER	
AMAZON	ZOMATO	FREECHARGE	COCA-COLA	AIRBNB	RENEW POWER		
MAKEMYTRIP	REGUS	IIFL	PIRAMAL	PVR	ERICSSON	QUICKHEAL	
CANON	ADANI	VML	PAYTM	SODEXO	9A BUSINESS	HAWORTH	HP
BAE	AUTODESK	TCS	PEARL ACADEMY	SAMSUNG	TATA MOTORS		
ADITYA BIRLA	TATA SKY	SOMANY	KALPATARU	ACCENTURE			
WESTERN UNION	LEGATO	SABA SOFTWARE	E-ZEST	COX & KINGS			
MAX	ATHENA	GLG	WINDSOR IT PARK	ERICSSON	ITPL		
MANIPAL HOSPITAL	GROHE	DELHI GYMKHANA	EON IT PARK KHARADI				
AZURE	SAS	TIBCO	DECCAN GYMKHANA	EDIFECS	BIRLASOFT		
LG CHEM	MARKIT	CLEO COUNTY	VALUE PLUS	SIRION LAB			
MOTT & MACDONALD	GODREJ	JAISPRING	IZENICA	DALMIA			
CLAIRVOLEX	AIRTEL	CUX CAPITAL	APCER	CLIFFORD	CINEPOLIS		
APOLLO TYRES	BAJAJ CAPITALS	BROWER STACK	CORNING				
UPES BIDHOLI	SONY	KAS	INDIABULLS	CSGI	LOHIA GROUP	BAJAJ	
FREECHARGE	RAYMOND	BKT	PEARSON	DIVERSE LYNX			
JAIPURIA SCHOOL	VARSA PLASTIC IOC	HYUNDAI MOTOR	YES BANK				
GOOGLE	SHAHI EXPORT	RADHANIK EXPORT	YES BANK	BANK OF BAHRAIN			
BANDHAN BANK	MARRIOT HOTEL	AMBUJA, KOLKATA					

Government

| DELHI INTERNATIONAL AIRPORT TERMINAL-3 | KATHMANDU AIRPORT - NEPAL |
| M.C. CHANDIGARH | EMBASSY OF SAUDI ARABIA, POLAND, BULGARIA, FINLAND,
THE REPUBLIC OF KOREA, THE REPUBLIC OF POLAND |
AMBASSADOR'S RESIDENCE OF POLAND	BIR HOSPITAL - NEPAL		
PUNJAB MANDI BOARD BHARAT PETROLUM	GOVERNMENT COLLEGE HARYANA		
INDIAN RAILWAY	RAPID METRO	HARYANA HIGH COURT	PHOOL BAGH
PUNJAB HOUSING BOARD	CIRCUIT HOUSE		
RAJIV INSTITUTE & RESEARCH CENTRE	SIR GANGA RAM HOSPITAL		
SHATABDI SPER	SPECIALITY HOSPITAL		
UTTAR PRADESH RAJKIYA NIRMAN NIGAM LTD.	PWD HARYANA		
KANPUR	DEVELOPMENT AUTHORITY	TAJ CORRIDOR	MINI SECRETARIAT
MUNICIPAL CORPORATION CHANDIGARH , BORDER SECURITY FORCE (BSF)			
DEPARTMENT OF AGRICULTURE COOPERATION AND FARMERS WELFARE -			
(NORTHERN FARM MACHINERY TRAINING & TESTING INSTITUTE HISSAR)			
ARMY HEADQUARTERS - NEPAL			



Terms & Conditions

- 1- All prices stated in the price list are in Indian Rupees (INR)
- 2- Prices are subject to change without any notice.
- 3- All products may vary from the photographs shown in this price list. Although every effort has been made to ensure accuracy in the compilation of the technical details in this publication.
- 4- Due to continual development and improvement process, product specs may change any time without prior notice.



Legero Lighting

Corporate Office

E-139, Sector 63, Noida - 201301, India
+91 120 4272775
info@legerolighting.com

Pune Office

Gate No. 1338/1, Priyanka Nagari,
Nagar-Pune Road, Jadhav Wasti,
Wagholi, Pune - 412207

legerolighting.com